



14

**LISTE DES OPERATIONS
STRUCTURE CARROSSERIE**

**ZX
800-000/1**

1

NUMERO DE L'OPERATION	DESIGNATION
ZX 800-000/1	- Liste des opérations figurant au chapitre 14
ZX 800-00/3	- Préparation d'une coque
ZX 800-00/4	- Remise en état de la coque I - Eléments vendus par D.P.R. II - Pièces en tôle électrozinguée ou galvanisée III - Pièces en tôle HLE
ZX 800-00/5	- Rezingage des tôles en réparation
ZX 800-0/1	- Contrôle d'une coque nue sur banc positif CELETTE
ZX 800-0/2	- Contrôle d'une coque (mécanique en place) sur banc positif CELETTE
ZX 800-0/10	- Contrôle d'une coque nue sur CAROLINER
ZX 800-0/11	- Contrôle d'une coque (mécanique en place) sur CAROLINER
ZX 800-0/20	- Contrôle d'une coque nue sur METRO 2000 CELETTE
ZX 800-0/21	- Contrôle d'une coque (mécanique en place) sur METRO 2000 CELETTE
ZX 801-3/1	- Remplacement d'une doublure d'aile AV
ZX 801-3/2	- Remplacement d'un brancard partiel
ZX 801-3/3	- Remplacement complet d'un brancard et d'un passage de roue AV
ZX 801-3/4	- Remplacement d'un brancard partie AV et passage de roue partiel
ZX 821-3/1	- Remplacement d'un côté d'habitacle complet
ZX 821-3/2	- Soudage des charnons sur caisse
ZX 821-3/3	- Remplacement d'une partie AV de côté d'habitacle
ZX 821-3/4	- Remplacement d'une partie centrale de côté d'habitacle
ZX 821-3/5	- Remplacement d'une partie AR de côté d'habitacle
ZX 821-3/6	- Remplacement d'une partie inférieure de côté d'habitacle
ZX 821-3/7	- Remplacement d'une doublure de côté d'habitacle
ZX 821-3/8	- Remplacement d'une doublure de bas de caisse
ZX 822-3/1	- Remplacement d'une aile AR
ZX 822-3/2	- Remplacement d'une doublure d'aile AR
ZX 823-3/1	- Remplacement d'un boîtier de feux AR
ZX 823-3/2	- Remplacement partiel d'un panneau AR
ZX 823-3/3	- Remplacement d'un panneau AR complet
ZX 825-3/1	- Remplacement d'un pavillon
ZX 831-3/1	- Remplacement partiel d'un plancher AR
ZX 831-3/3	- Remplacement d'un longeronnet AR



14



ZX
800-00/3

1



90-1402

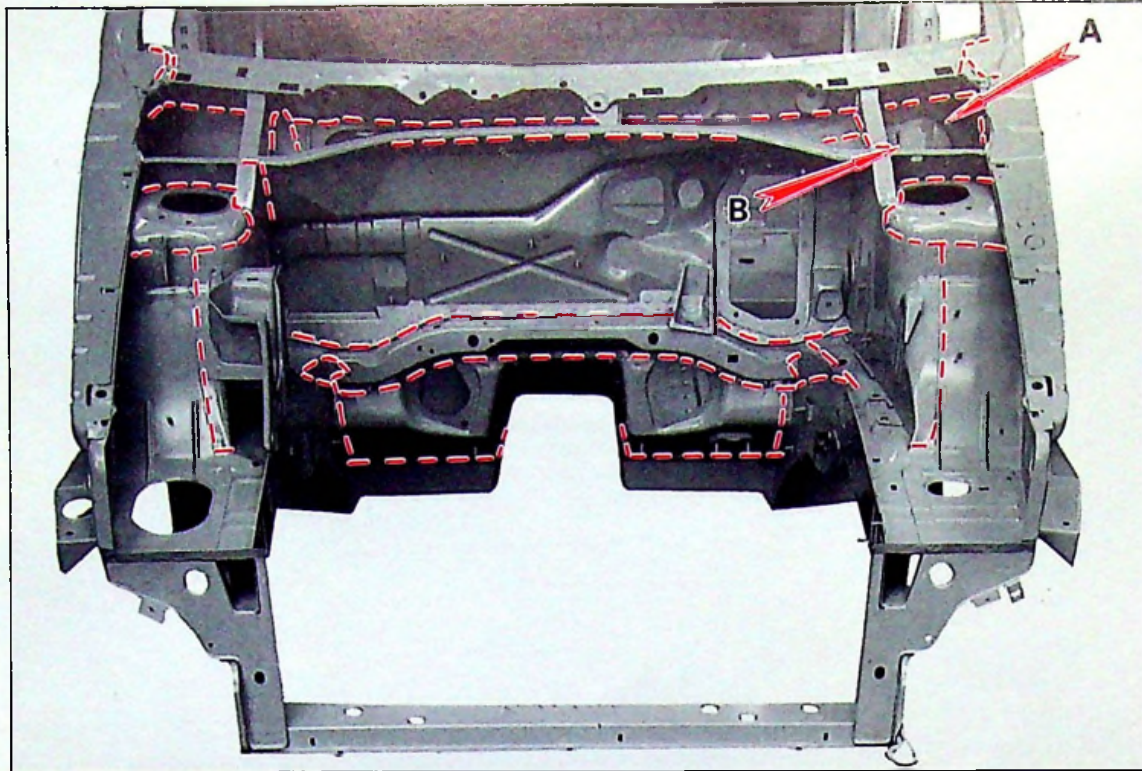

90-1094

→ A

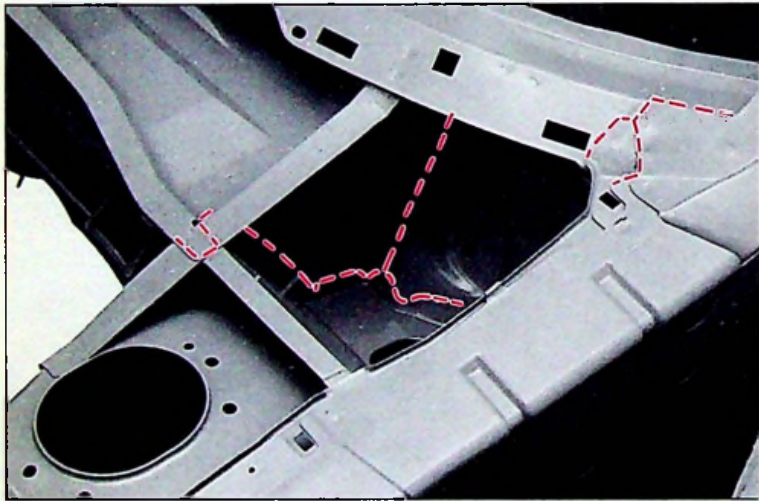

90-1101

→ B

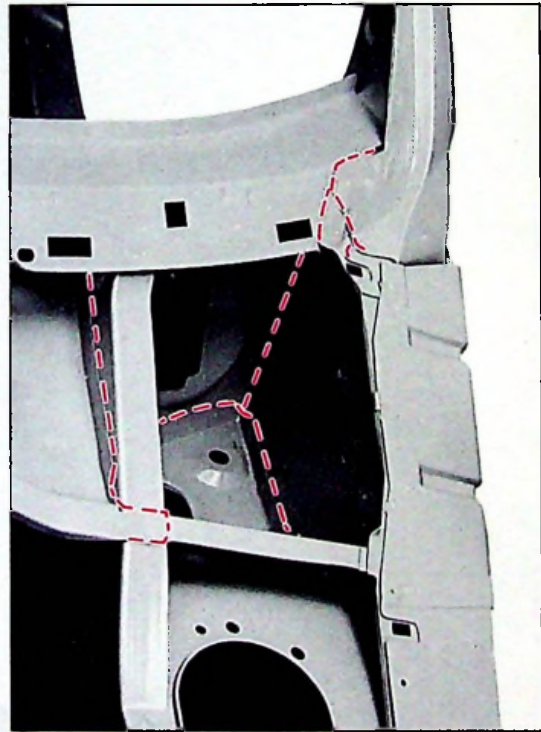

90-1102



14



A1 → - - - -

ZX
800-00/3

3

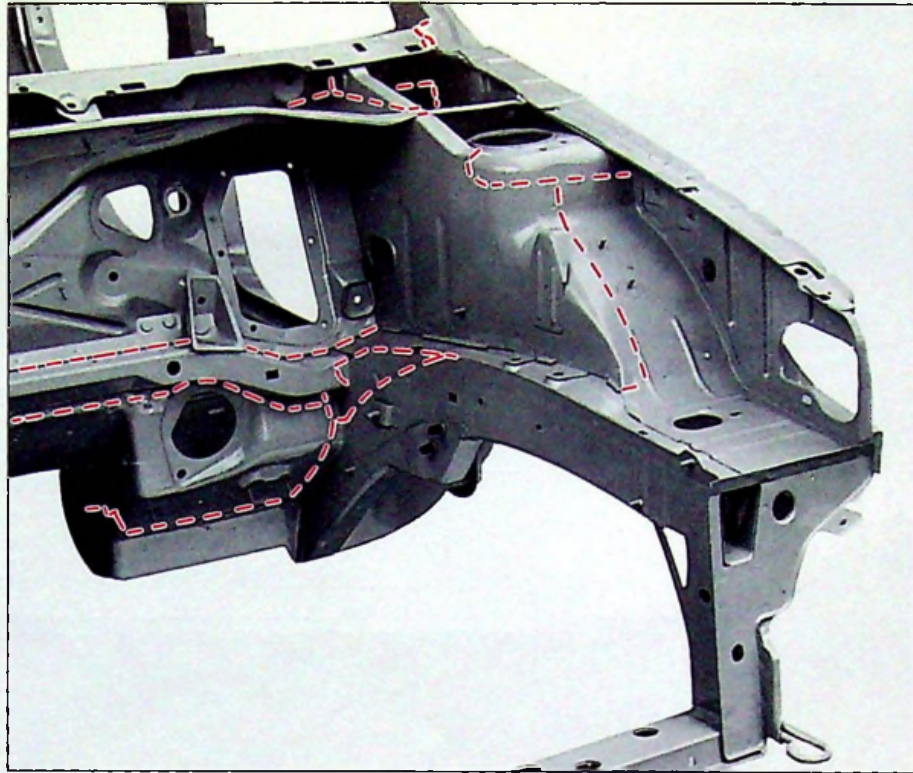

90-1074

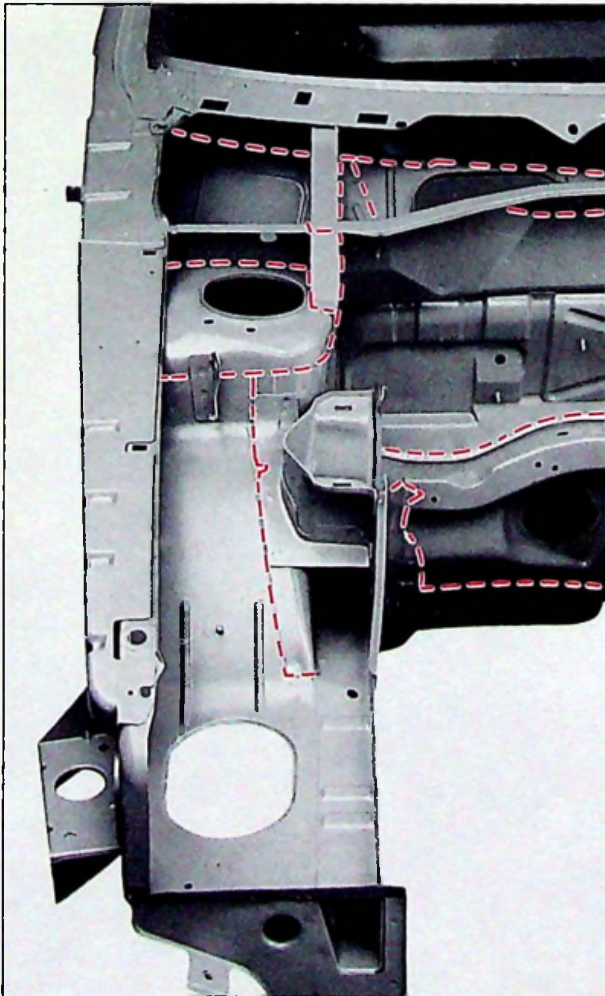

90-1078

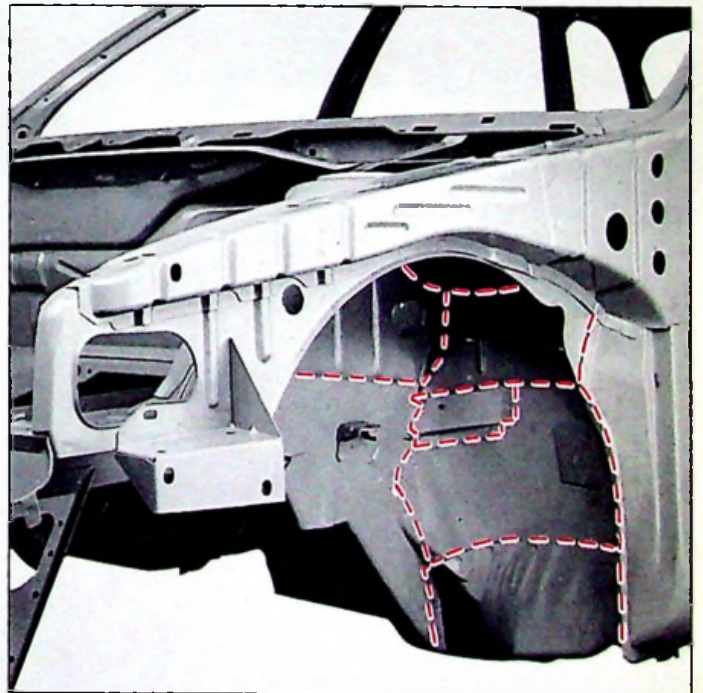

90-1090

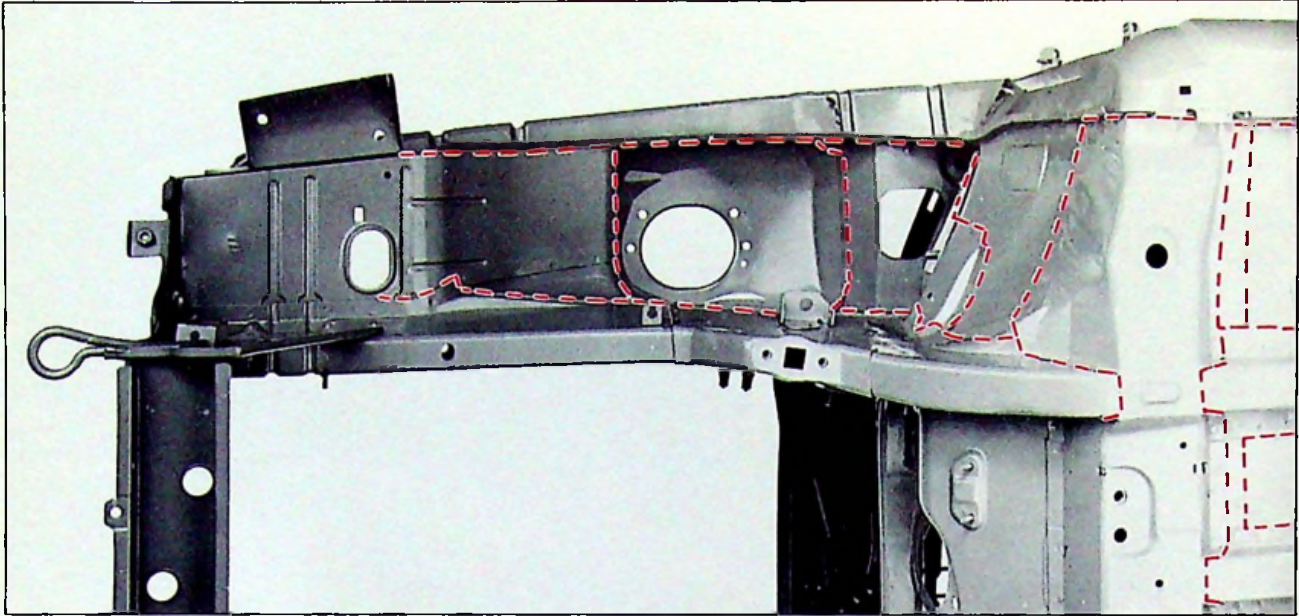

90-1071

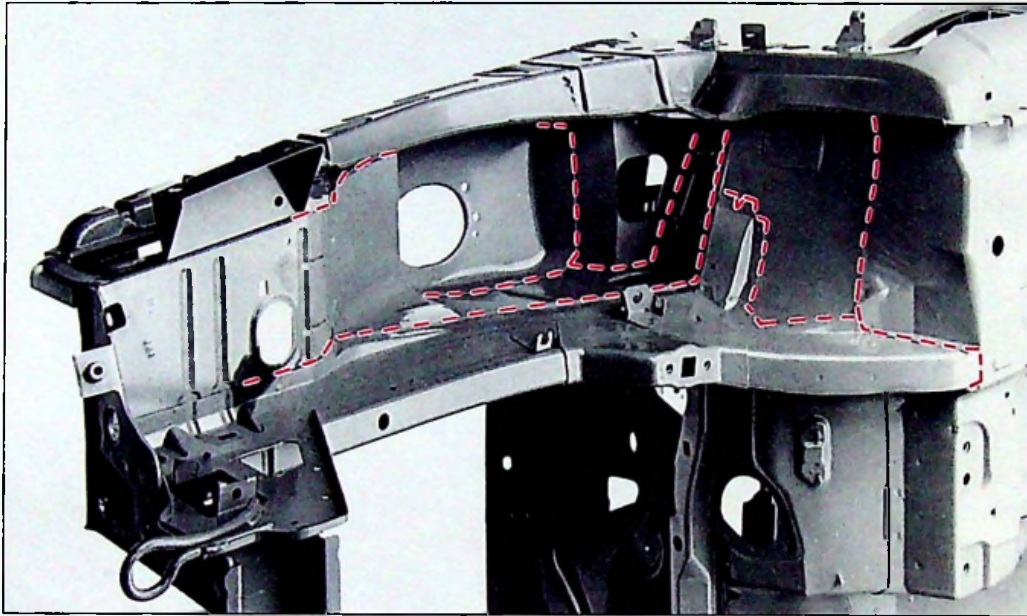

90-1073

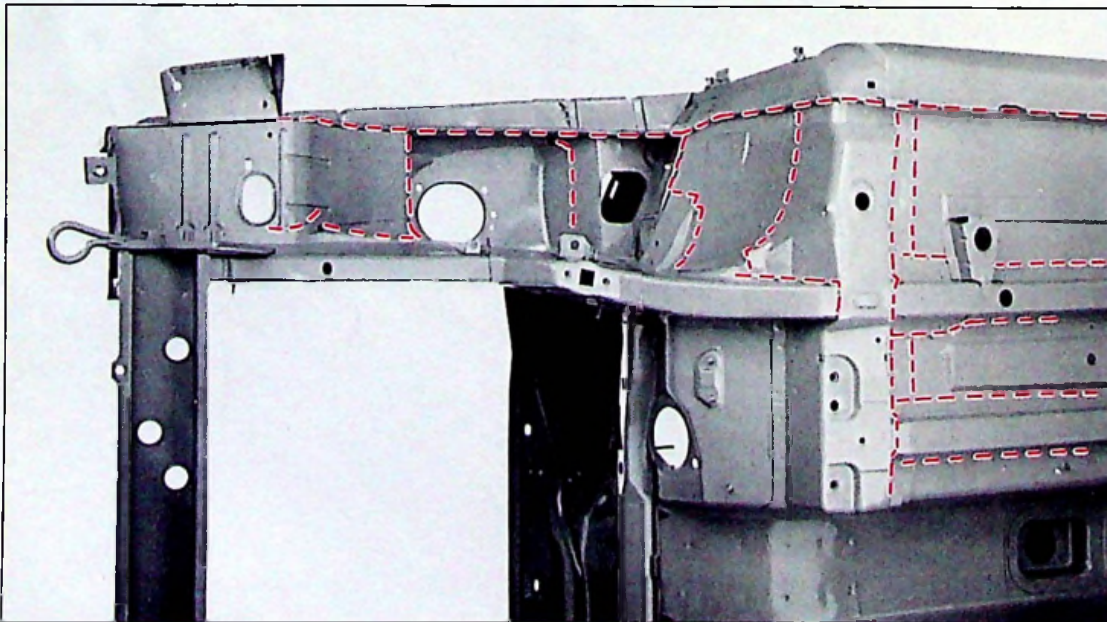

90-1068



14



A1 → - - - - -

ZX
800-00/3

5



90-1080

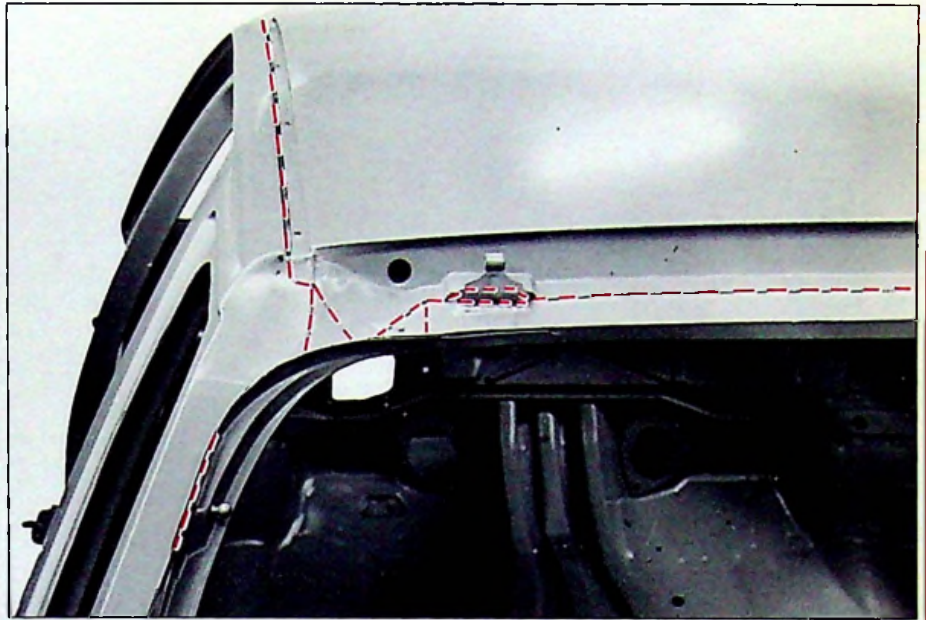

90-959



90-964

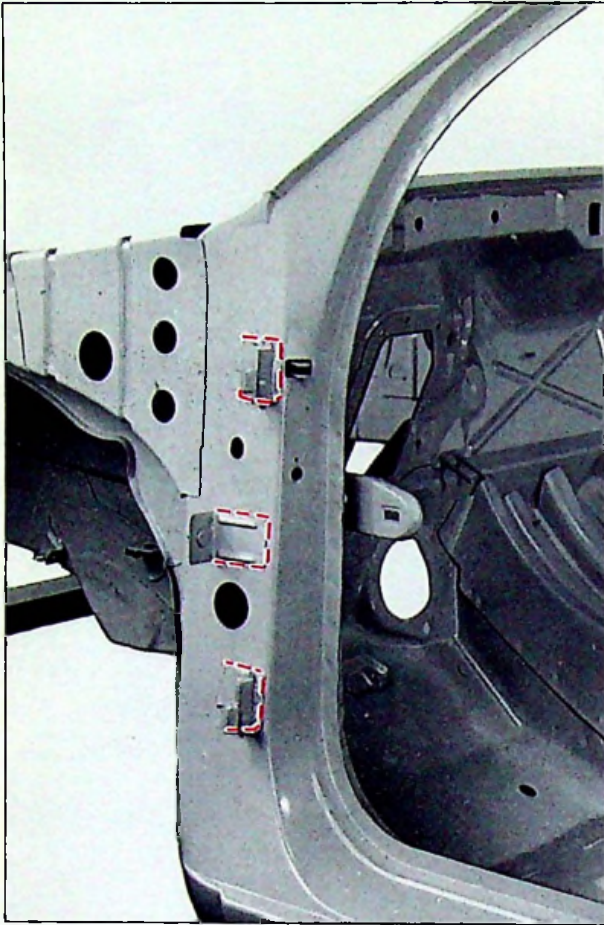

90-1083

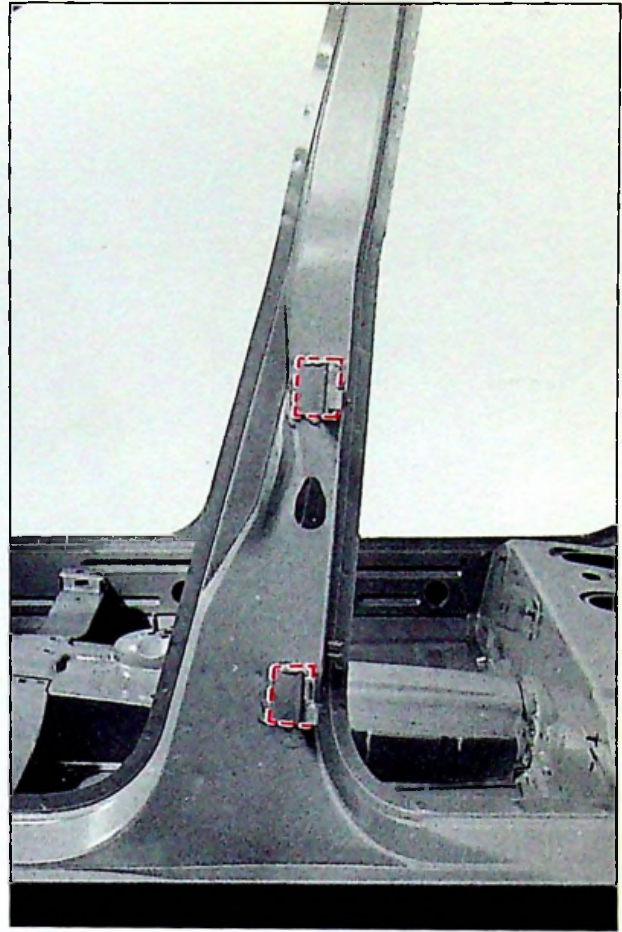

90-1082

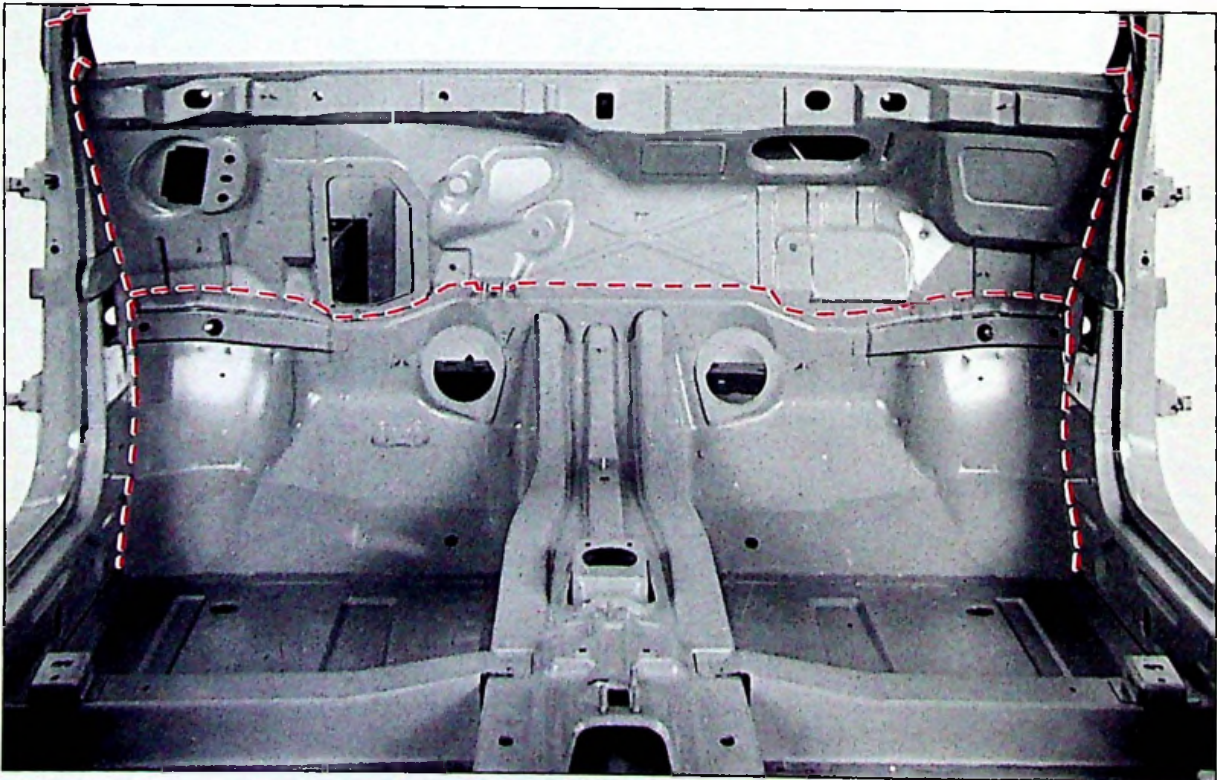

90-1081



14



A1 → - - - -

ZX
800-00/3

7

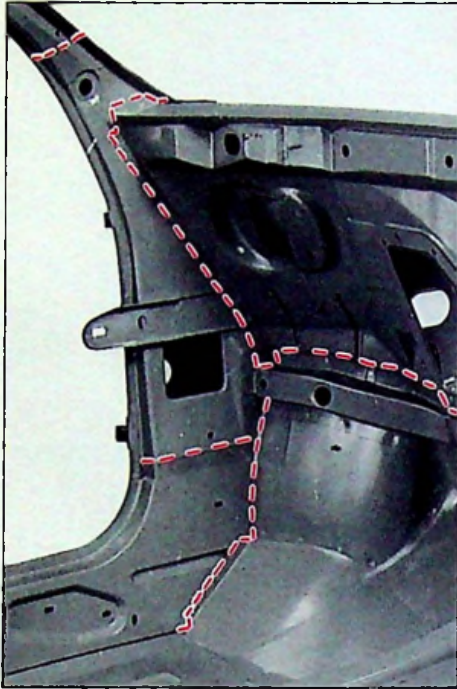

90-1076

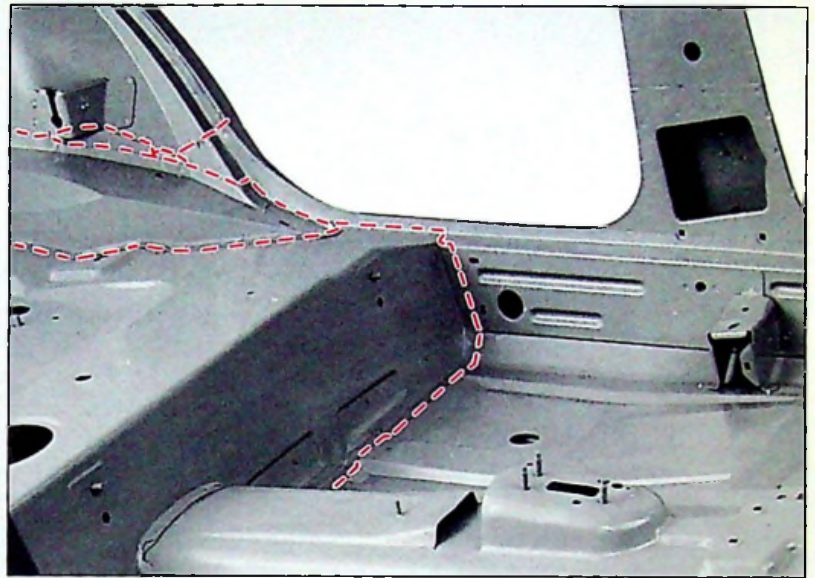

90-1095

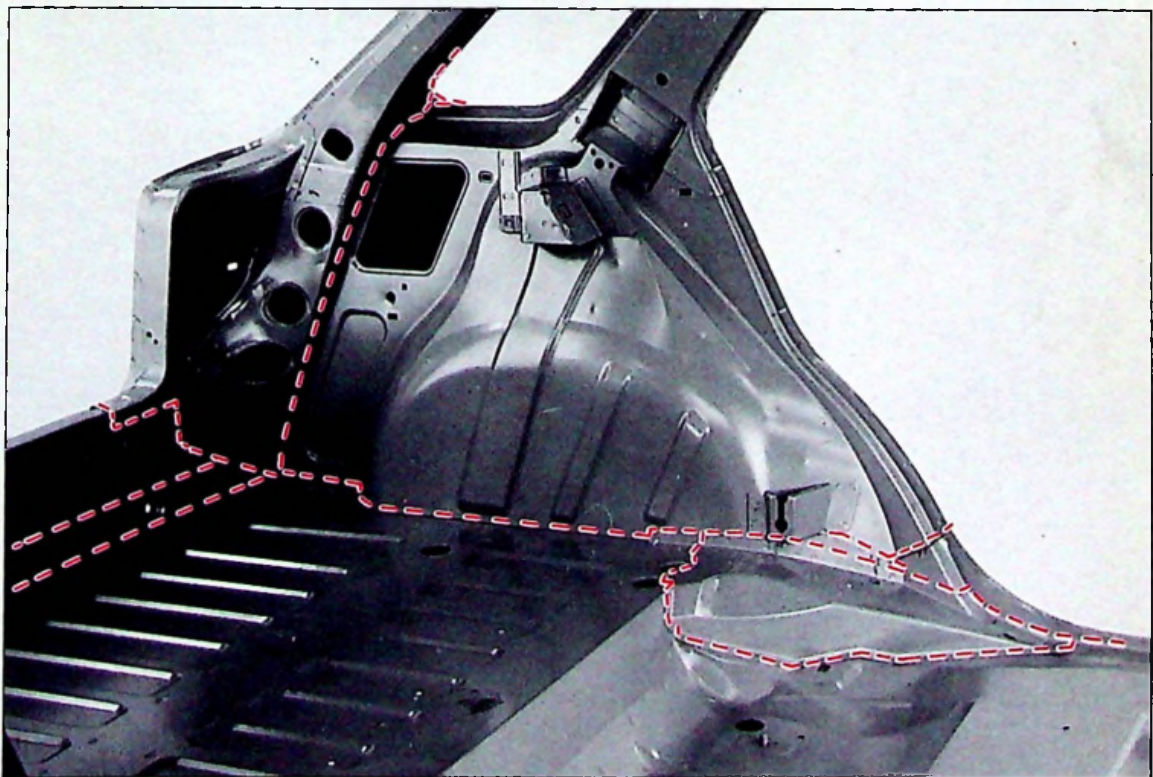

90-1099

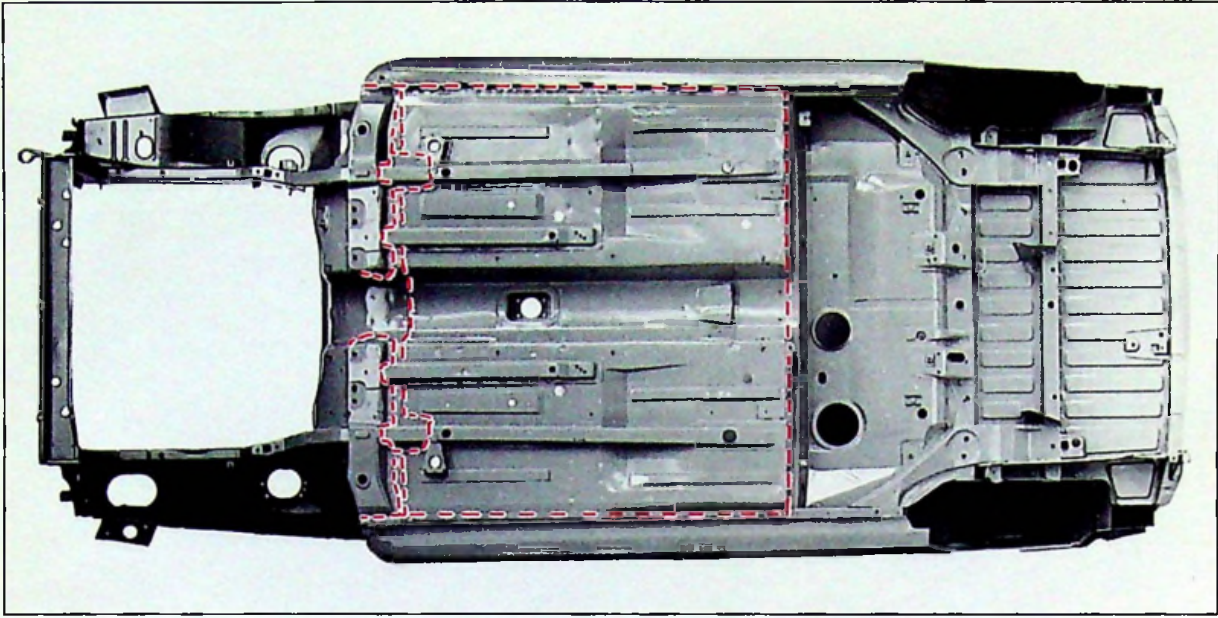

90-1070

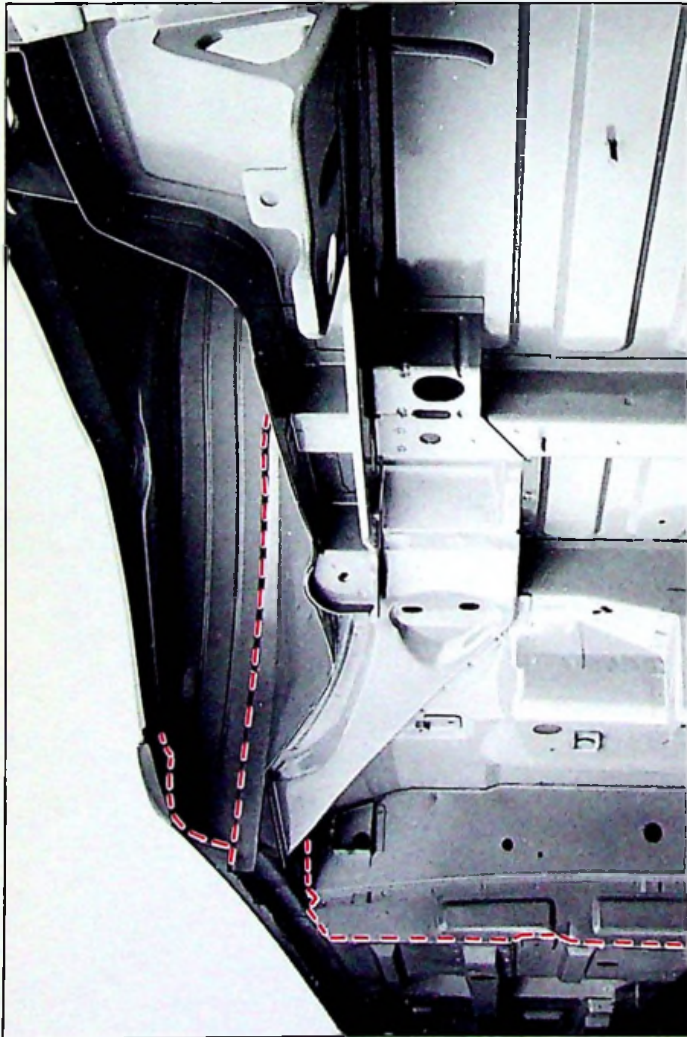

90-1072

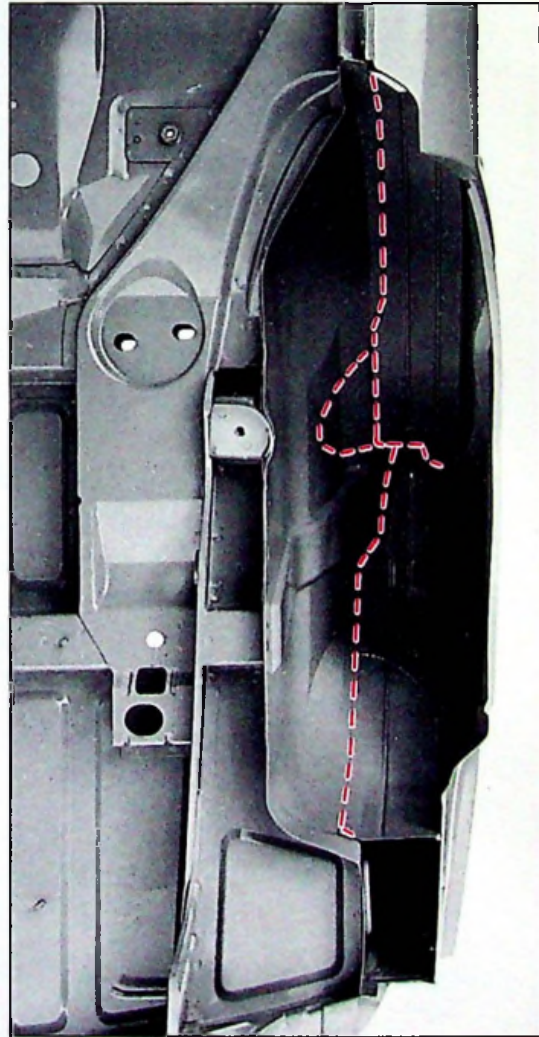

90-1064



14



A1 → - - - -

ZX
800-00/3

9

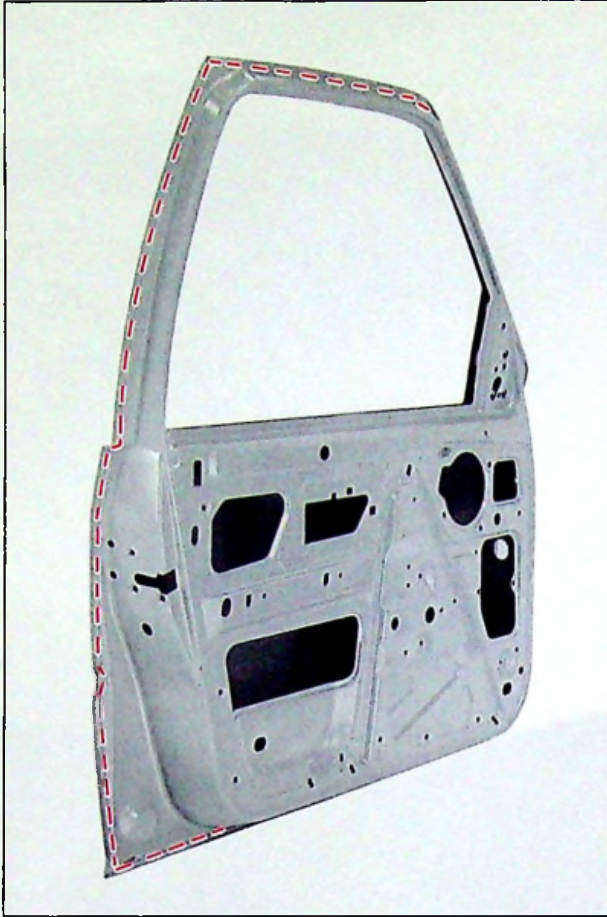

90-1180

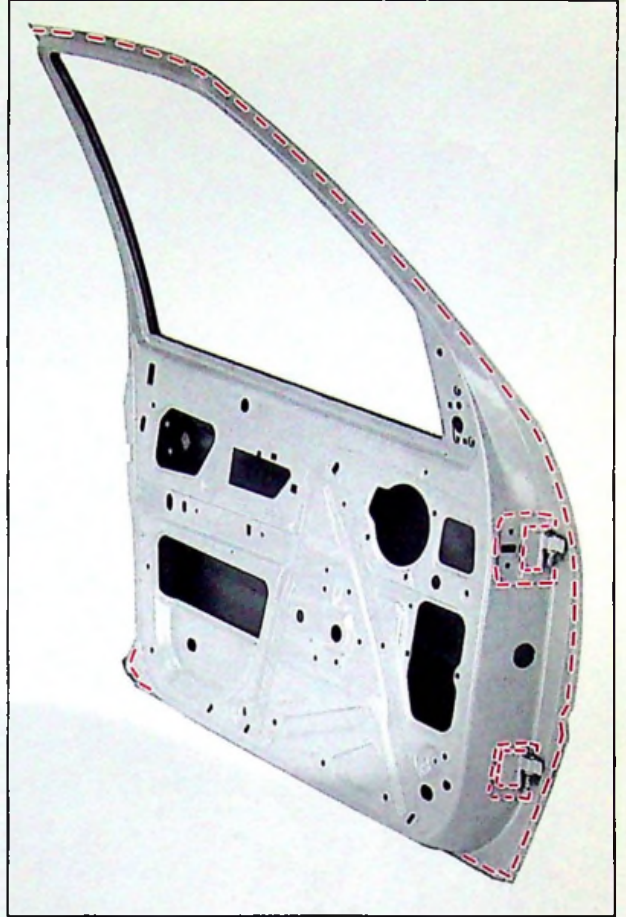

90-1181

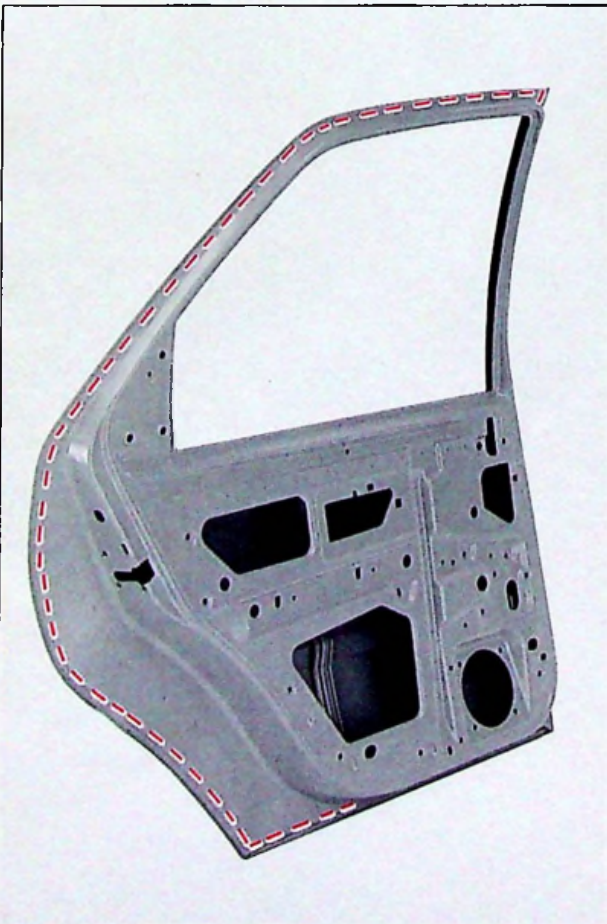

90-1177

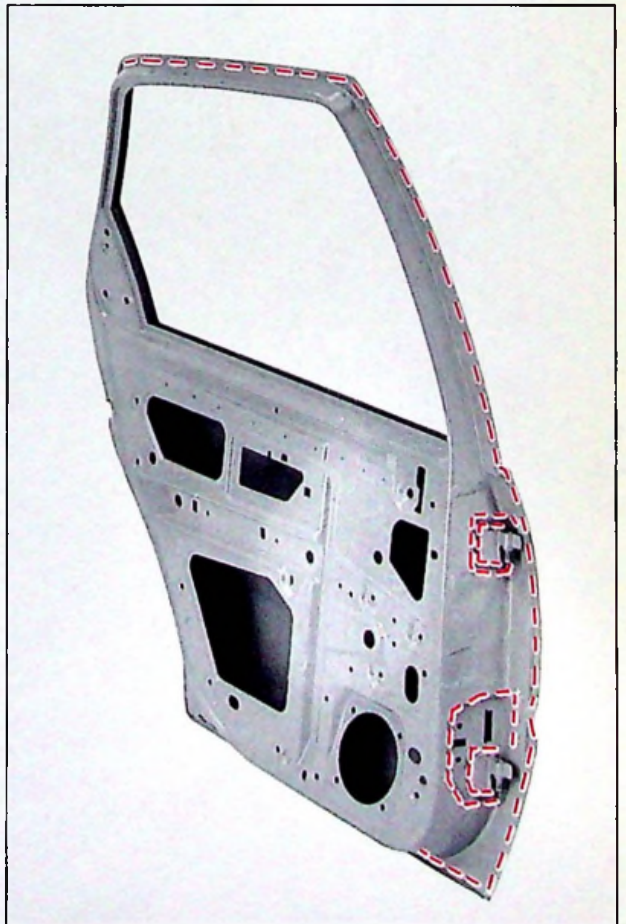

90-1176



A1 → - - - - -

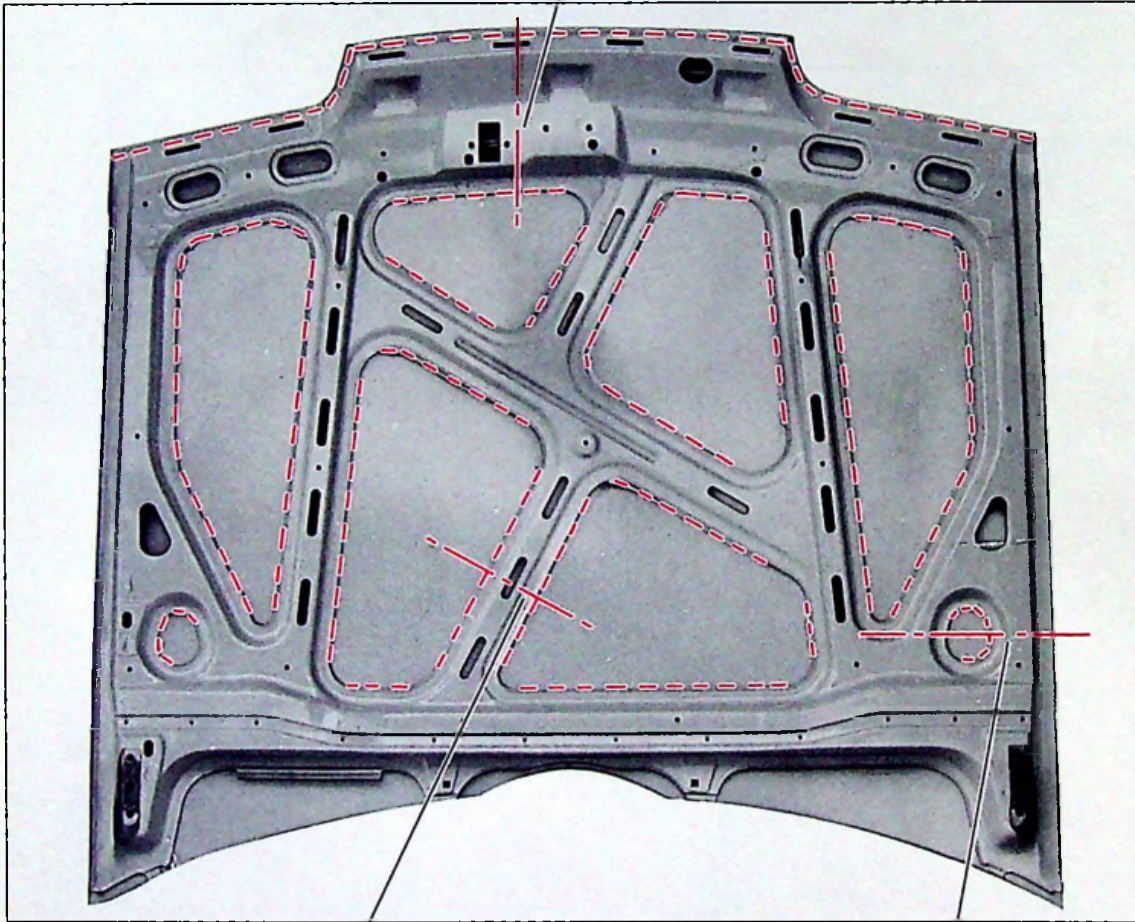
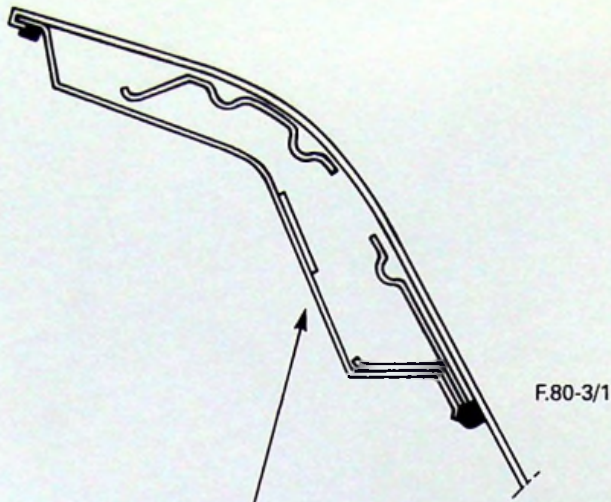

90-1173

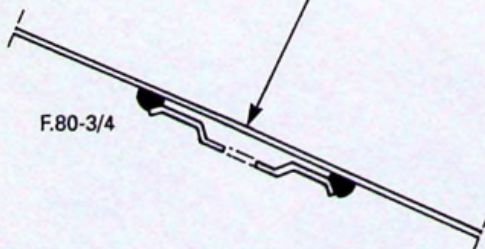



14



C3

ZX
800-00/3

11

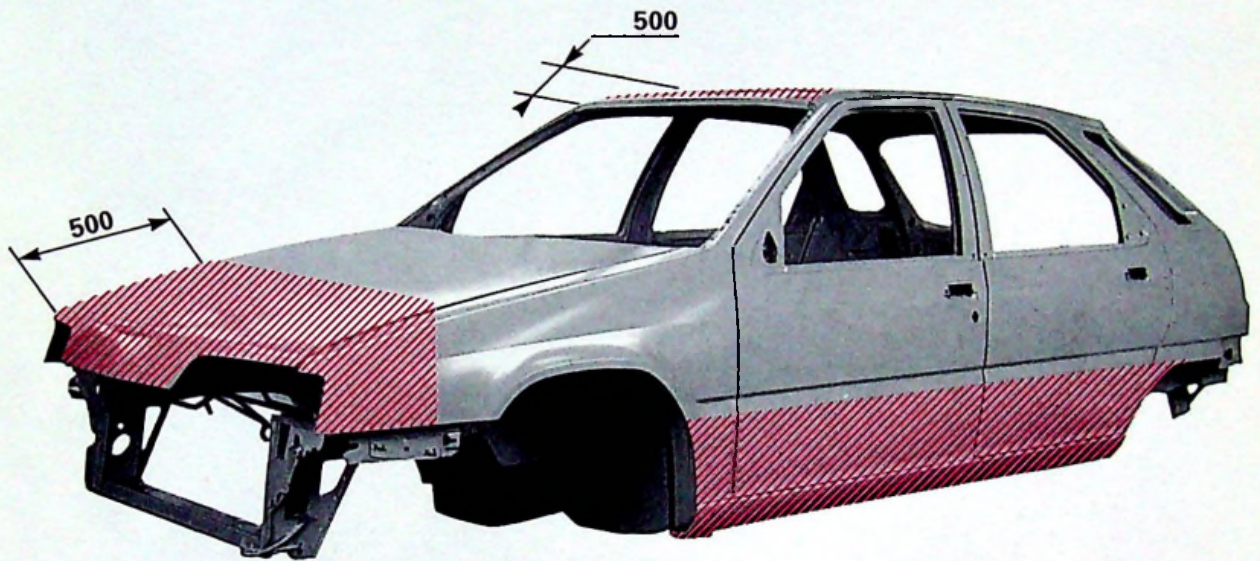

90-1402

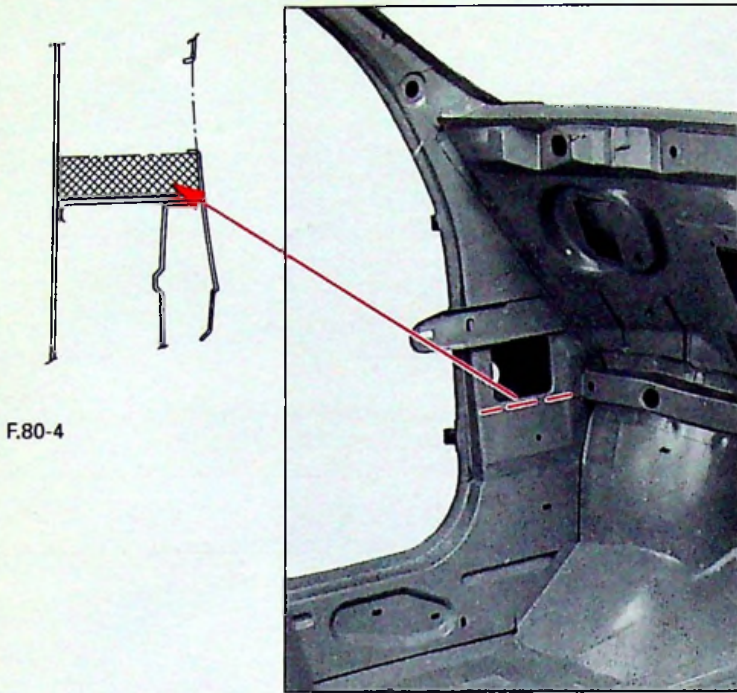
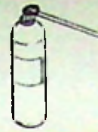

F.80-4

90-1076



F.80-4

90-1087

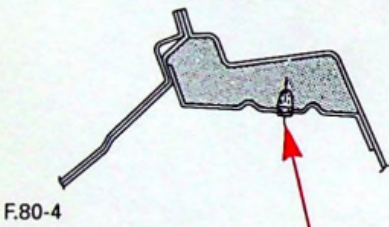

F.80-4

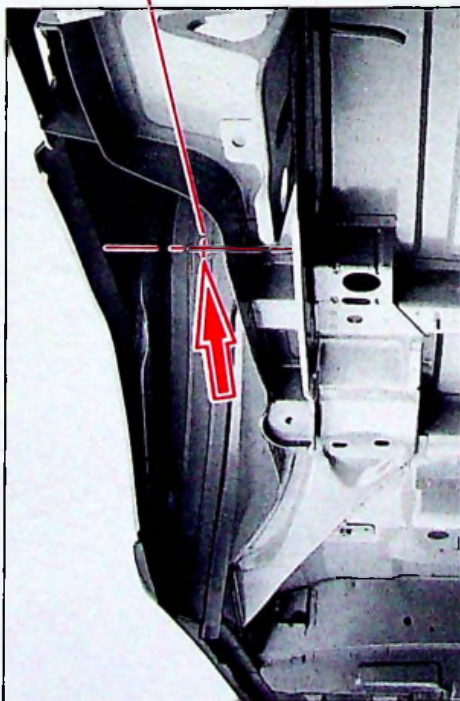

90-1072

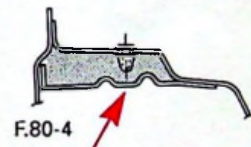

F.80-4

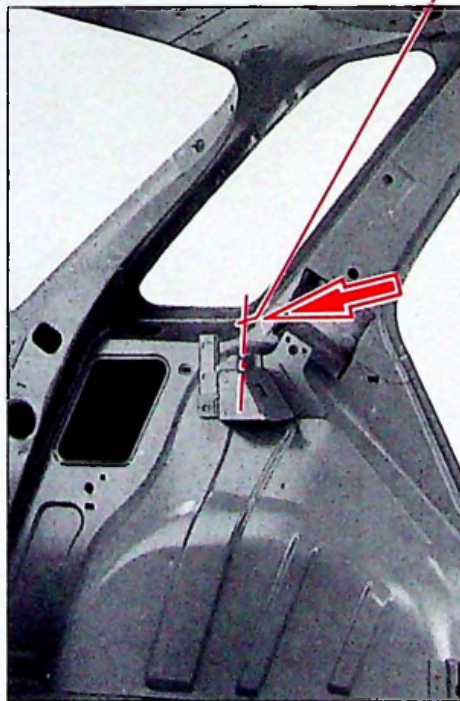

90-1098



14

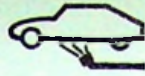

C1

ZX
800-00/3

13

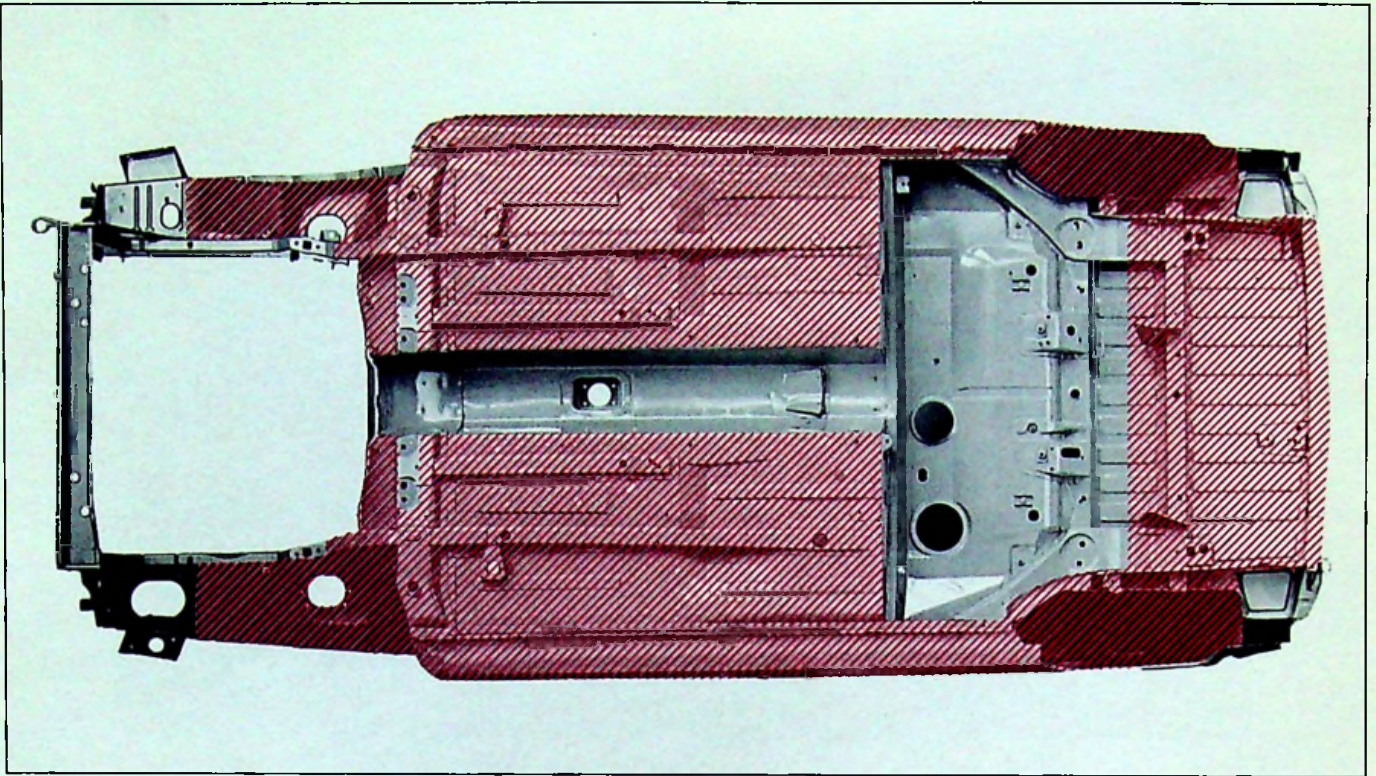

90-1070

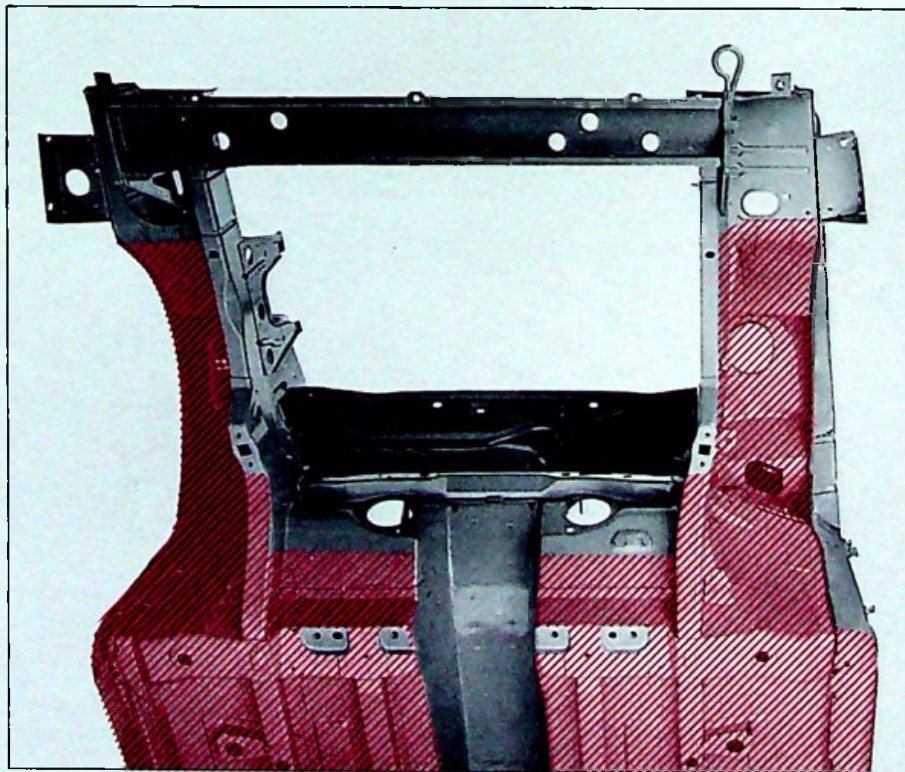

90-1068

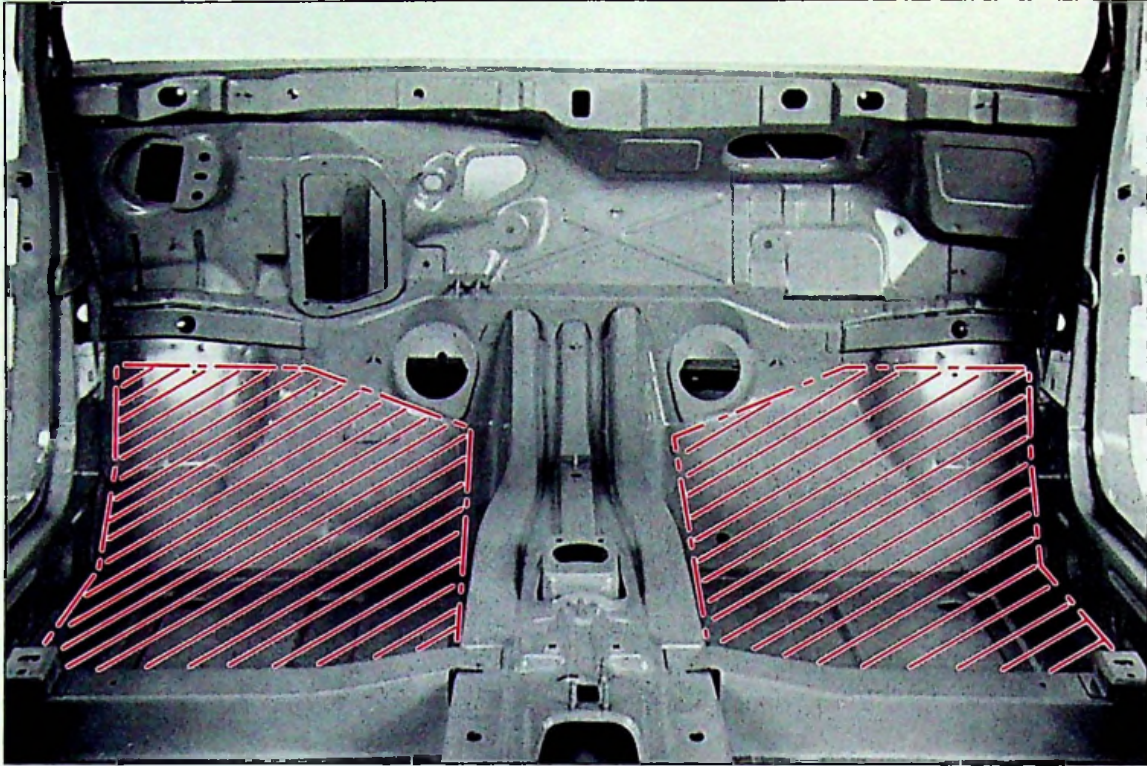

90-1081

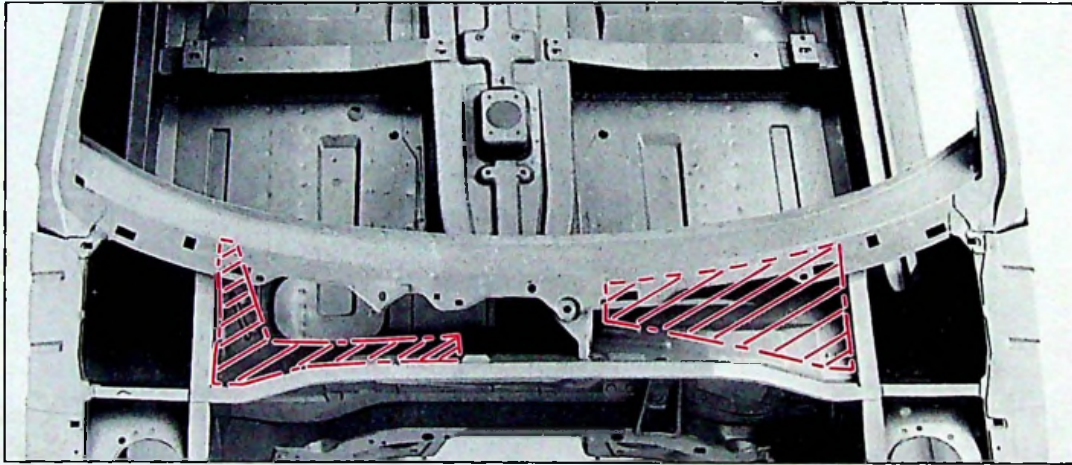

90-1069

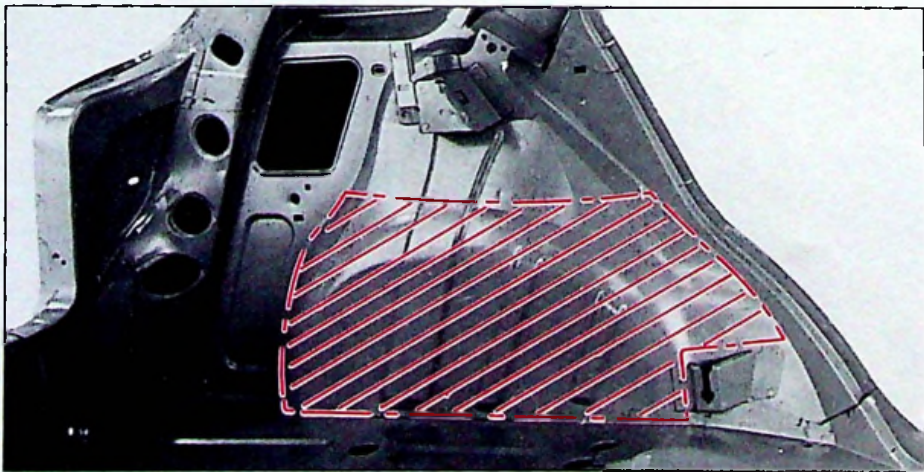

90-1059



14

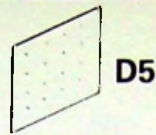

ZX
800-00/3

15

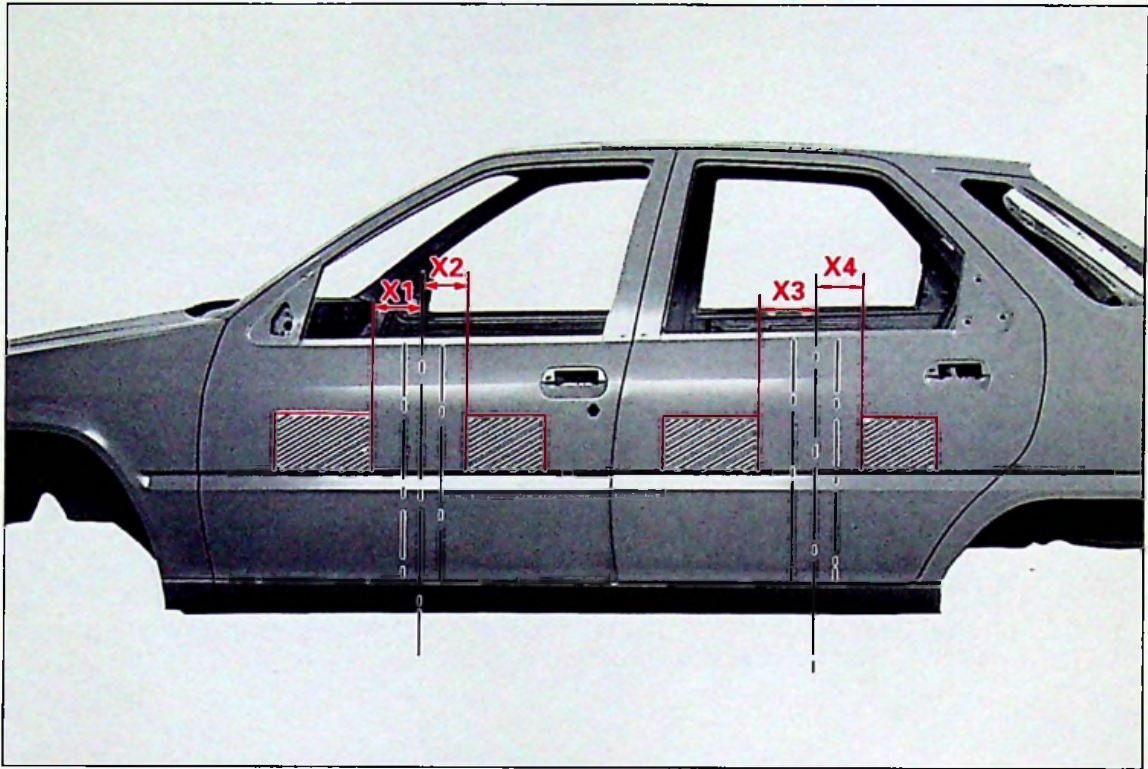

90-1403

X 1	40	± 5
X 2	50	± 5
X 3	100	± 5
X 4	15	± 5



14

COQUE

ZX
800-00/4

1

REMISE EN ETAT DE LA COQUE



I - ELEMENTS VENDUS PAR LE DEPARTEMENT DES PIECES DE RECHANGE

REPERE	DESIGNATION	N° OPERATION
1	Caisse en blanc	
2	Traverse supérieure de baie	825-3/1
3	Pavillon	825-3/1
4	Traverse AR de pavillon	825-3/1
5	Doublure de montant de baie G et D	821-3/6
6	Doublure d'arc de papillon G et D	821-3/6
7	Gouttière de volet AR G et D	821-3/6
8	Renfort de boîtier de feu AR G et D	823-3/1
9	Boîtier de feu AR G et D	823-3/1
10	Plancher AR assemblé	831-3/2
11	Plancher AR préparé	831-3/1
12	Traverse inférieure de panneau AR	823-3/2 - 823-3/3
13	Doublure de panneau AR	823-3/2 - 823-3/3
14	Panneau AR nu	823-3/2 - 823-3/3
15	Embout de traverse AV de plancher AR G et D	831-3/5
16	Renfort latéral de plancher AR G et D	831-3/3
17	Renfort de butée de talonnage G et D	831-3/3
18	Longeronnet AR G et D	831-3/3
19	Traverse milieu plancher AR	831-3/4
20	Traverse AV de plancher AR	831-3/5
21	Côté d'habitacle G et D	821-3/1
22	Côté d'habitacle partie AV G et D	821-3/3
23	Côté d'habitacle partie centrale G et D	821-3/4
24	Côté d'habitacle partie AR G et D	821-3/5
25	Côté d'habitacle partie basse G et D	821-3/6
26	Charnon	821-3/2
27	Renfort intérieur de montant de baie G et D	821-3/3
28	Ame de longeron G et D	821-3/7
29	Longeron intérieur G et D	821-3/7
30	Traverse d'assise AV partie latérale G et D	821-3/7
31	Doublure de montant de pied central G et D	821-3/4
32	Doublure de côté d'habitacle AR G et D	822-3/2
33	Doublure de pied AR G et D	821-3/5
34	Renfort doublure d'aile AV G et D	801-3/1
35	Support de pare-chocs AV G et D	801-3/1
36	Doublure d'aile AV G et D	801-3/1
37	Passage de roue AV G et D	801-3/3
38	Passage de roue AV partie AV G et D	801-3/2
39	Semelle AR de brancard AV G et D	801-3/3
40	Brancard AV G et D	801-3/3
41	Brancard AV partie AV G et D	801-3/4
42	Semelle de brancard AV G et D	801-3/4
43	Support de pilotage plancher AV	801-3/3
44	Traverse AV de brancard	801-3/3
45	Tablier inférieur	812-3/1 - 812-3/2
46	Traverse de tablier	812-3/1 - 812-3/2
47	Ensemble tablier supérieur	812-3/2
48	Doublure de traverse inférieure de baie	812-3/2
49	Traverse inférieure de baie	812-3/2
50	Flasque support moteur D	801-3/3
51	Support moteur D	801-3/3

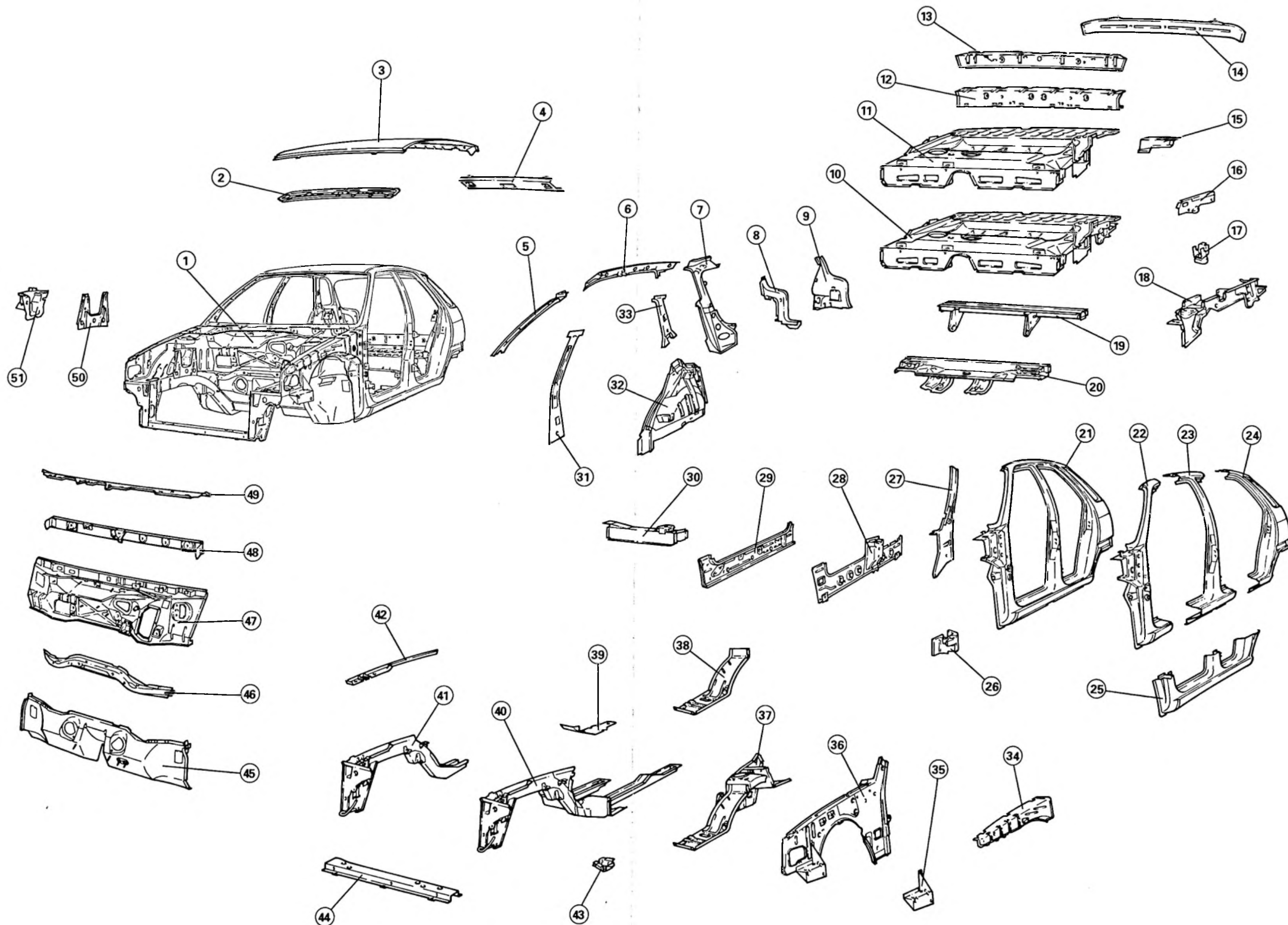

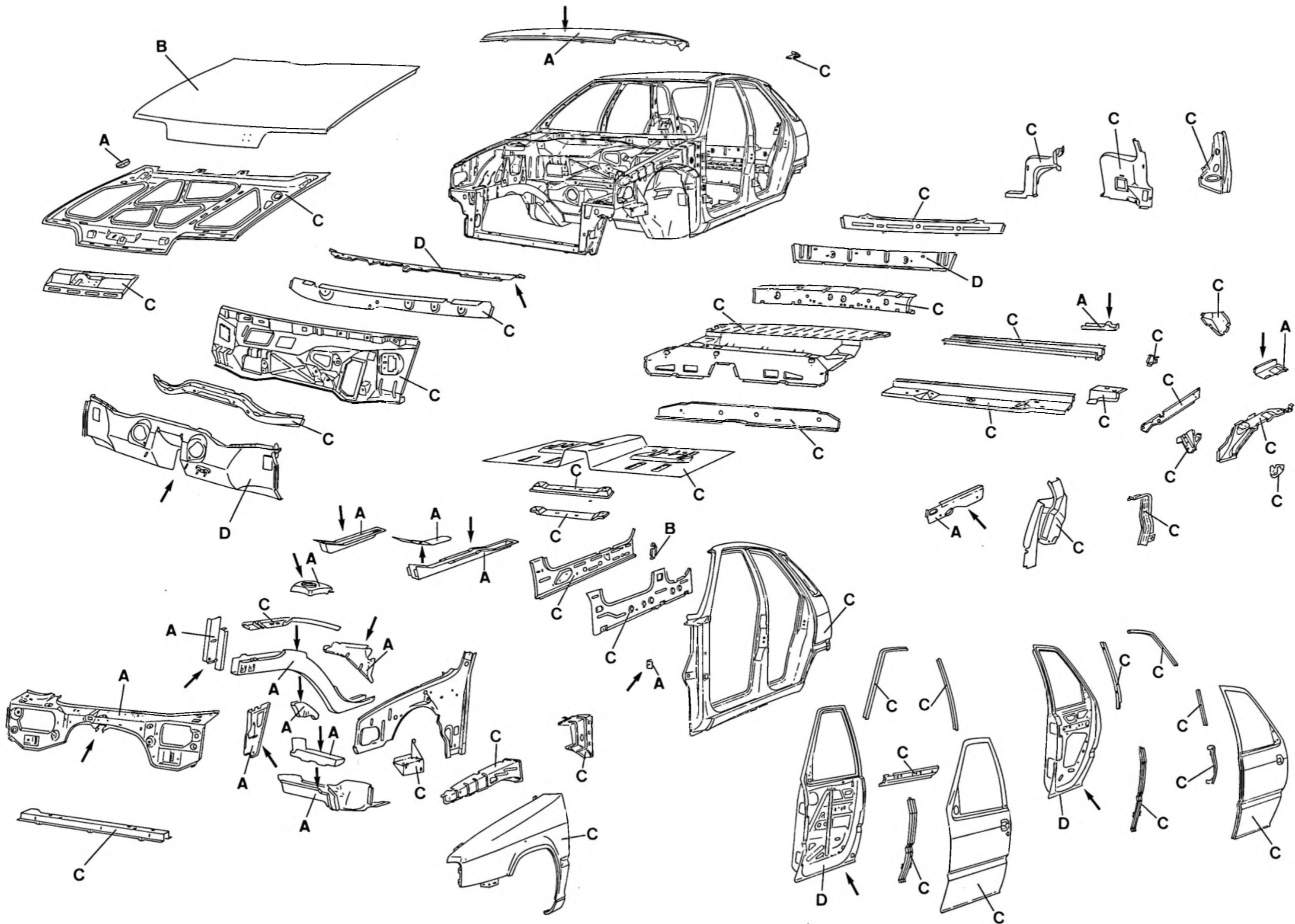



14

II. PIECES EN TOLES REVETUES DE ZINC

Les pièces représentées dans les vues ci-contre comportent un revêtement de zinc afin de les prémunir contre la corrosion.

On distingue différents types de revêtements de zinc (voir repères sur schémas).

- A** : Tôle EZ 10/0 ⇒ électrozinguée 1 face, épaisseur de zinc : 10 microns,
B : Tôle EZ 10/10 ⇒ électrozinguée 2 faces, épaisseur de zinc : 10 microns,
C : Tôle G 10/10 ⇒ galvanisée 2 faces, épaisseur de zinc : 10 microns,
D : Tôle G 10/01 ⇒ galvanisée 1 face, 1 face broyée.

NOTA : La → indique la face revêtue pour les tôles de qualité **A** et **D**.

Ce choix de pièce prérevêtue est fait en fonction de la vulnérabilité de certaines zones et est susceptible d'évolutions.

Les pièces vendues par le Département des Pièces de Rechange comportent les mêmes revêtements, mais n'apparaissent pas en raison de la couche de cataphorèse.

REPARATION DE LA COQUE

En réparation, il est nécessaire de détruire la couche de cataphorèse sur les deux faces des tôles dans les zones de soudage, ce qui par la même occasion détériore le revêtement au zinc.

Pour éviter que la réparation (en particulier les zones de soudage) soit le point de départ du processus de corrosion, il convient de prendre certaines précautions :

- éviter de décaper par meulage les zones de soudure des pièces neuves (les disques abrasifs détruisent la couche de zinc), mais utiliser plutôt une brosse métallique ou à fibre adaptable sur une perceuse pneumatique ;
- limiter le meulage, après dégrafage, aux zones où il y a surépaisseur de soudure ;
- dégraffer les pièces à remplacer par fraisage des points de soudure à l'aide de forêts spéciaux (affûtés à plat).

Protection avant soudure

Pour assurer une protection correcte de la face interne des bords à souder par points (tôles électrozinguées ou pas), il est indispensable :

- soit d'appliquer une couche de 50 microns de peinture au zinc (≈ 3 couches avec un aérosol) ;
- soit de rezinguer les zones "décapées" à l'aide d'un poste de rezinguage (voir: 14 ZX 800-00/5) ;
- d'ajouter un mastic d'étanchéité conducteur dans les cas d'une liaison étanche.

REMARQUE : les peintures au zinc ne doivent en aucun cas être utilisées comme sous-couches pour d'autres revêtements (peinture ou produits de protection).

ELEMENTS EXTERIEURS (Portes - capot - volet - ailes)

Ils sont tous en tôle zinguée sur les deux faces et susceptibles de subir des opérations de redressage qui détruisent la couche de zinc.

Dans tous les cas lorsque cette couche de zinc est détériorée, il faut la refaire à l'aide du POSTE DE REZINGAGE.

Voir op. 14 ZX 800-00/5

III. PIECES EN TOLES "H.L.E"

La recherche pour l'allègement des véhicules et l'accroissement de la sécurité des occupants conduit les constructeurs automobile à se pencher sérieusement sur la nature des matériaux utilisables pour concevoir la superstructure des carrosseries.

Comme d'autres véhicules CITROËN (AX-BX-XM), la ZX bénéficie de cet apport technique que représente les **Tôles à Haute Limite Elastique**.

REPARATION

Assemblage

Les tôles à haute limite élastique (H.L.E) ne posent aucun problème particulier pour ce qui concerne les solutions d'assemblage par soudure, par résistance ou MAG, mais il convient toutefois de respecter les solutions de coupe et d'assemblage préconisés dans les gammes de réparation.

Le soudage au chalumeau et le brasage sont des solutions d'assemblage à PROSCRIRE quelle que soit la nature des tôles.

Redressage

Les tôles H.L.E. peuvent être redressés pratiquement comme les autres.

Seul est à PROSCRIRE le redressage à chaud qui crée un affaiblissement local pouvant aller jusqu'à la rupture, en particulier sur les fortes épaisseurs des pièces de structure.

Précautions à prendre :

- effectuer seulement du redressage à froid ;
- redonner la forme exacte notamment les angles, arêtes sur les pièces de structure telles que longerons, brancards, traverses... (toute trace, même légère de plis est une zone affaiblie).

Il est à noter que ces consignes se vérifient à un degré légèrement moindre sur des tôles de qualité classique.

Lorsque ces consignes ne peuvent être respectées, il faut échanger la pièce.

LISTE DES PIECES EN TOLE "H.L.E" SUR ZX

- 1 Charnon fixe de volet AR
- 2 Renfort de fixation d'équilibreur
- 3 Support de berceau de roue de secours
- 4 Renfort de fixation de frein secondaire
- 5 Support de cric
- 6 Appui de chandelle
- 7 Support de suspension D
- 8 Flasque support moteur D

Nota : cette liste est susceptible d'évolutions.



14

ZX
800-00/4

9

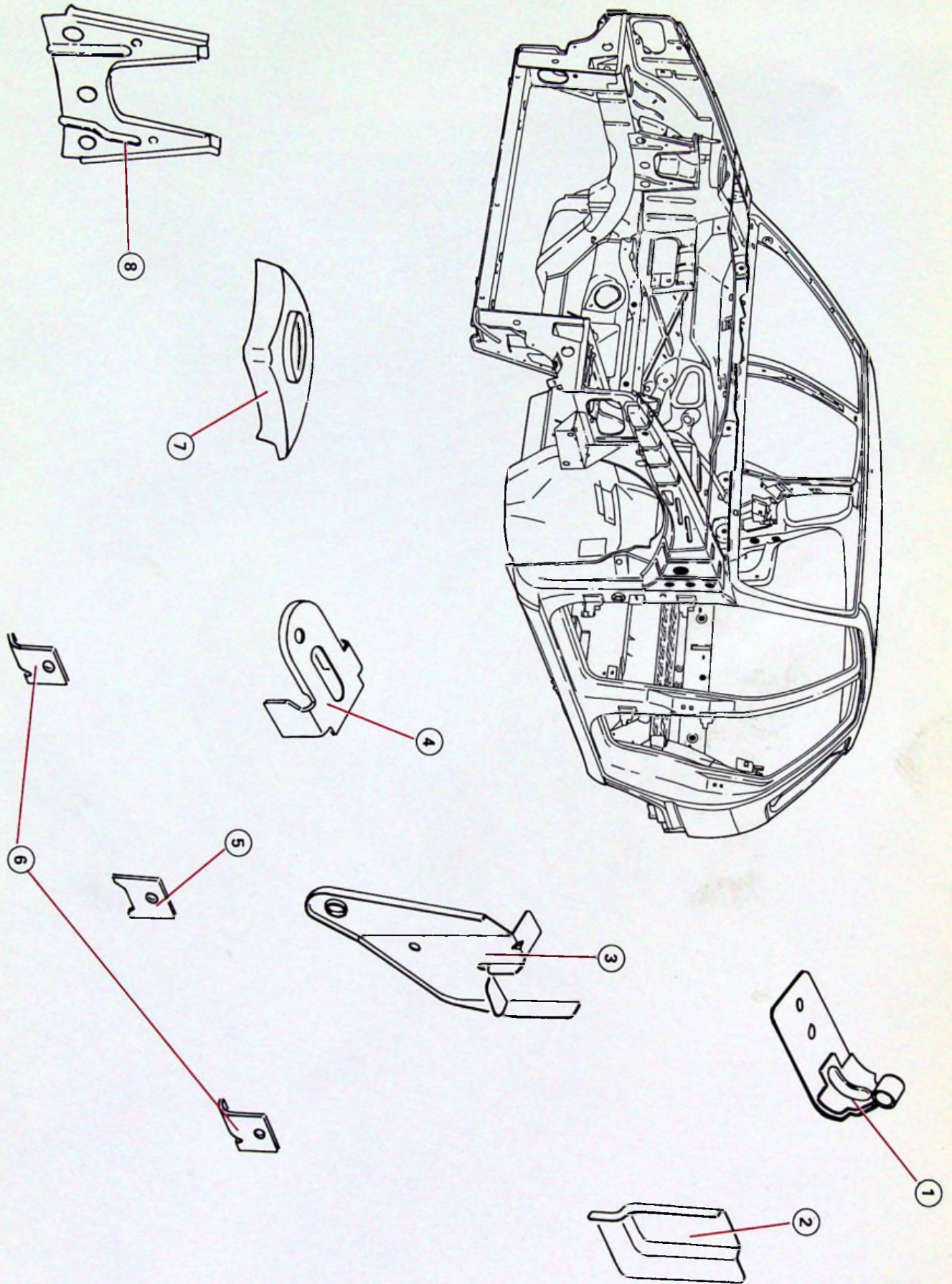

F.80-18
F.80-10



14

REZINGAGE DES TOLES EN REPARATION

ZX
800-00/5

1

Sur le véhicule ZX de nombreuses tôles sont revêtues de zinc (par électrozingage ou galvanisation) et notamment tous les éléments extérieurs qui le sont sur les deux faces.

Ces revêtements peuvent être détruits dans de nombreux cas de figure :

- rayures,
- opérations de redressage,
- réfection de liaisons soudées

Pour obtenir une qualité de réparation aussi proche que possible de celle d'origine, il faut refaire cette couche de zinc si celle-ci a été détériorée.

MATERIEL
MODE OPERATOIRE

**COMPOSITION DE L'UNITE D'ELECTROZINGAGE 9008-T**

Servante :

- ① - 1 générateur 12 V (à brancher sur 220 V).
- ② - 1 anode Ø 100 (pour grandes surfaces planes).
- ③ - 1 anode Ø 50 (pour surfaces planes "moyennes").
- ④ - 5 anodes Ø 13 (pour surfaces petites, d'accès difficile : peut être taillé à la forme souhaitée, à l'aide d'une lime).
- ⑤ - 1 porte-tampon (RSE) pour anodes Ø 50 et 100 mm.
- ⑥ - 1 adaptateur pour anodes Ø 50 et 100 mm.
- ⑦ - 1 porte-tampon (AX) pour anodes Ø 13 mm.
- ⑧ - 2 cordons 3 m (noir pour " - ", rouge pour " + ").
- ⑨ - 1 récipient en plastique (pour solution au zinc).
- ⑩ - 25 bonnettes pour anode Ø 13 mm.
- ⑪ - 10 bonnettes pour anodes Ø 50 et 100 mm.
- ⑫ - 3 litres solution au zinc.

MODE OPERATOIRE**Préparation de la surface :**

- Décaper, poncer avec papier 280.
- Dégraisser avec solvant non gras.

Mise en service

Brancher le générateur sur 220 V.

Brancher les cordons (noir sur borne correspondante du générateur et masse pièce, rouge sur borne correspondante du générateur et porte tampon).

Humidifier à l'eau la bonnette choisie pour faciliter l'imprégnation de zinc.

Visser l'anode sur le porte-tampon et fixer la bonnette.

Verser un peu de solution au zinc dans le bac plastique et déposer l'anode dedans.

Régler le potentiomètre du régulateur sur position 6. Lors de la déposition de zinc, l'ampèremètre indiquera 20A (ce réglage permet une déposition régulière).

Déposition du zinc

A l'aide de l'ensemble tampon et bonnette imbibé de zinc, balayer plusieurs fois la surface à traiter (vous remarquerez alors un changement de couleur de la surface).

Un dépôt d'épaisseur de **10** microns est demandé.

Temps nécessaire pour déposer 10 microns sur 1 dm² : **environ 2 mn.**

Consommation de solution zingage N : **1 l/m².**

Nettoyage après zingage

Rincer abondamment la surface traitée à l'eau du robinet.

Effectuer un ponçage avec un papier super fin (P 1000 ou 1200), essuyer, sécher.

Peinture

La mise en peinture doit se faire immédiatement après zingage pour éviter toute oxydation superficielle, sinon reponcer.

REMARQUE :

Les anodes doivent être régulièrement poncées au papier abrasif pour assurer une bonne conduction électrique.

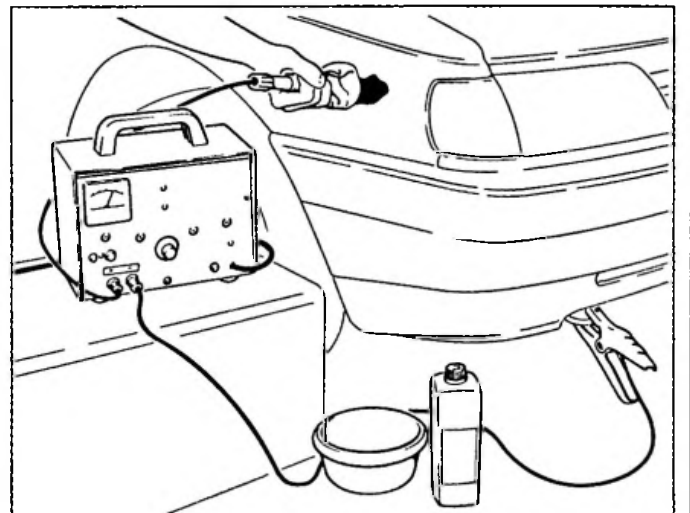
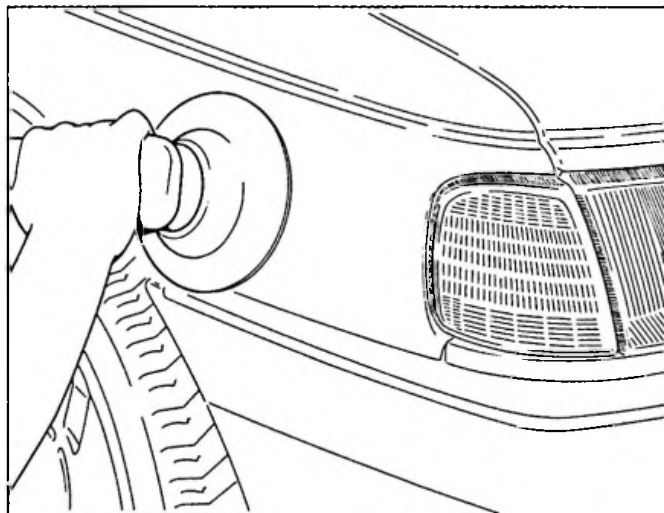
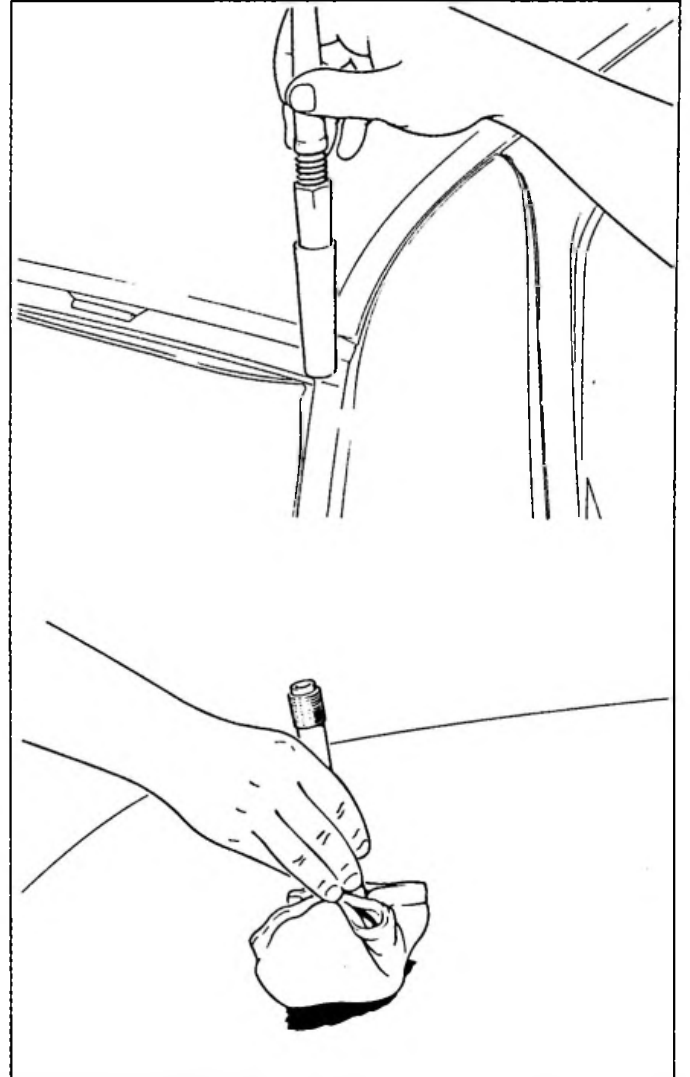
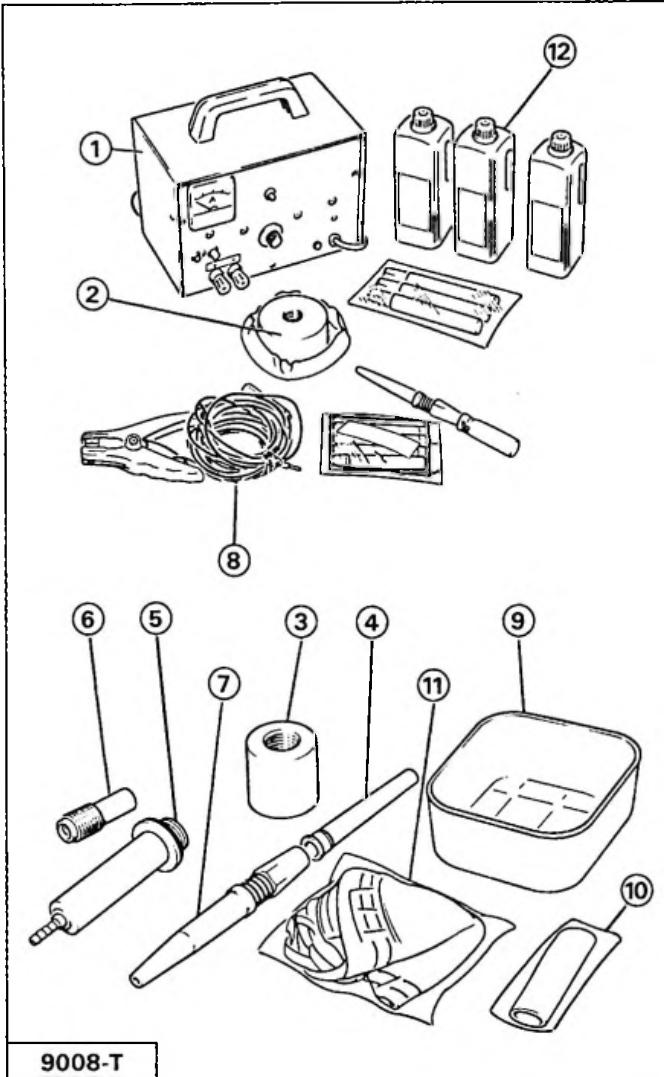



14

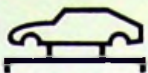

CELETTE

ZX
800-0/1

1

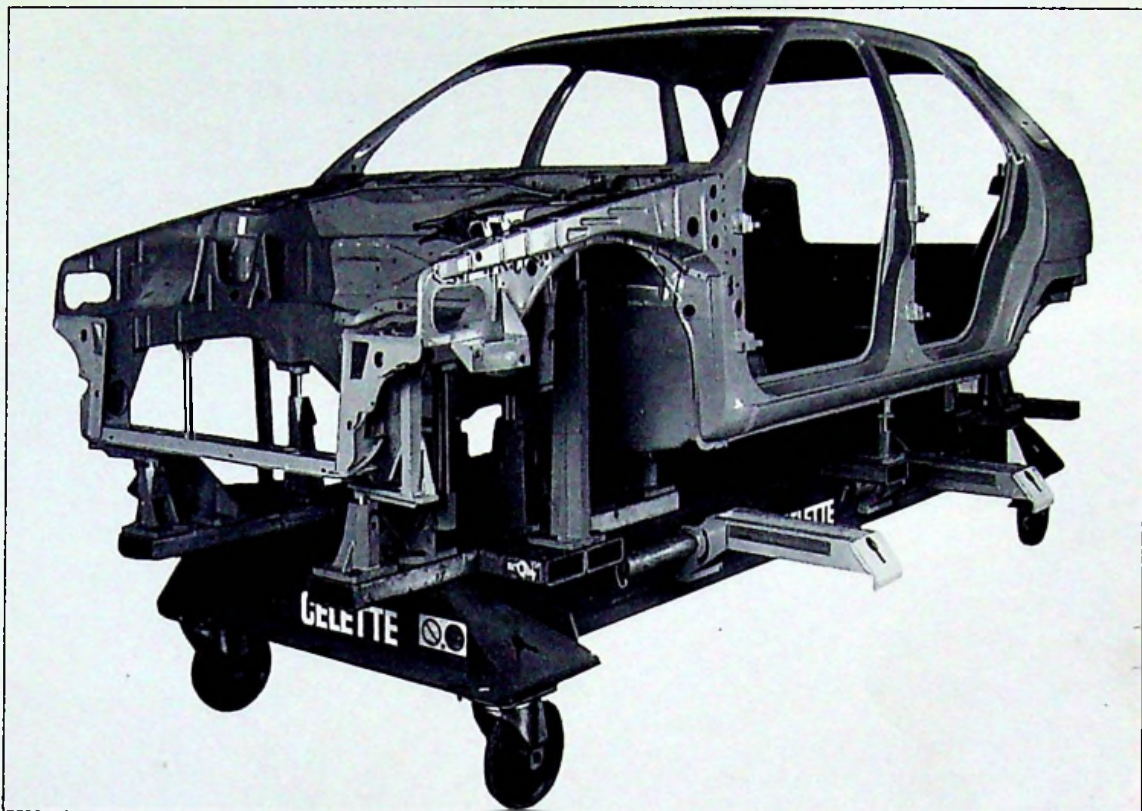

90-1644

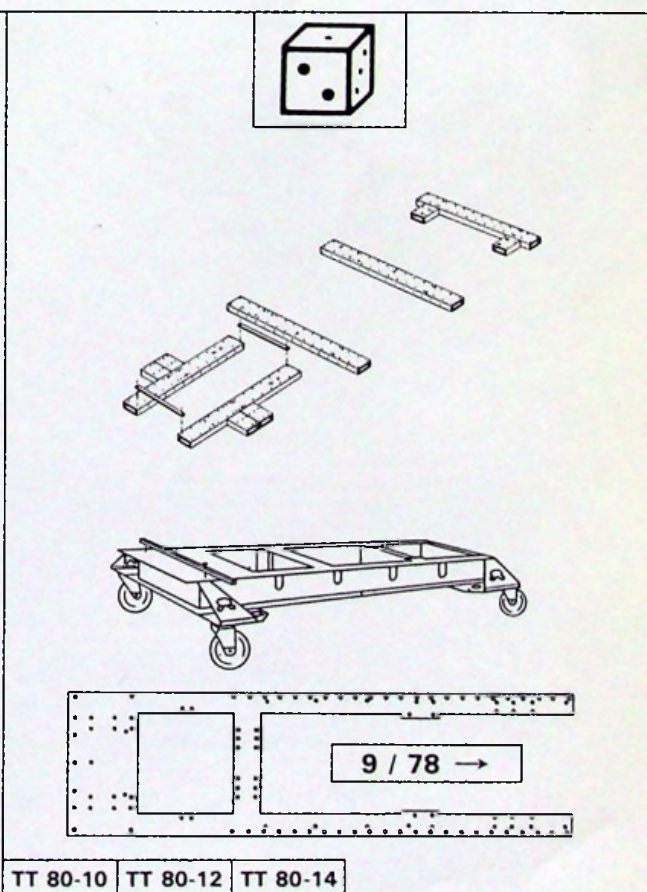
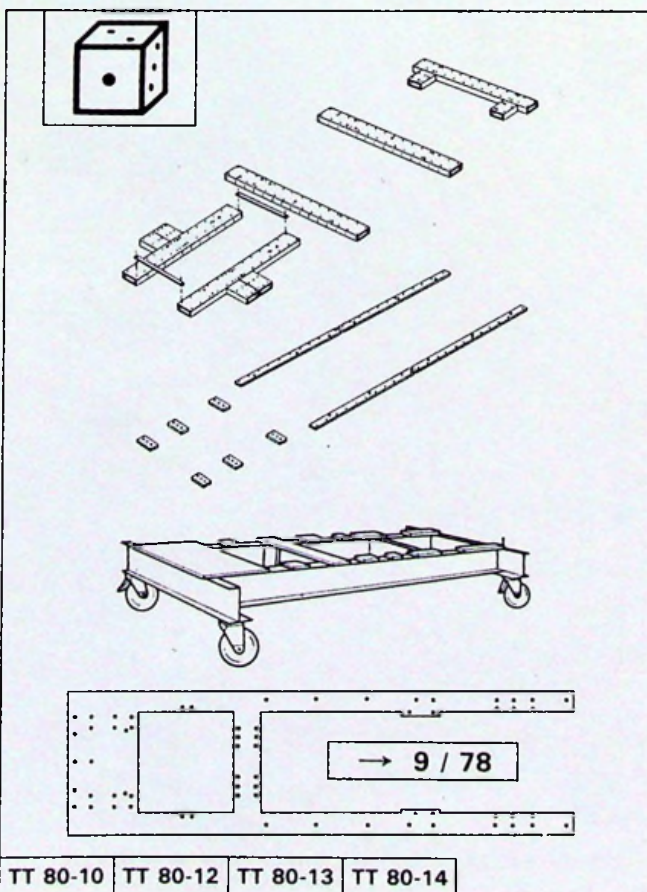



CELETTE MZ

Détails									
Réf des Détails	MZ080	MZ140	MZ141	MZ142	MZ200	Z260	MZ601	MZ602	TV400
Quantité	6	2	1	1	4	4	1	1	1

REFERENCE CELETTE 612.300

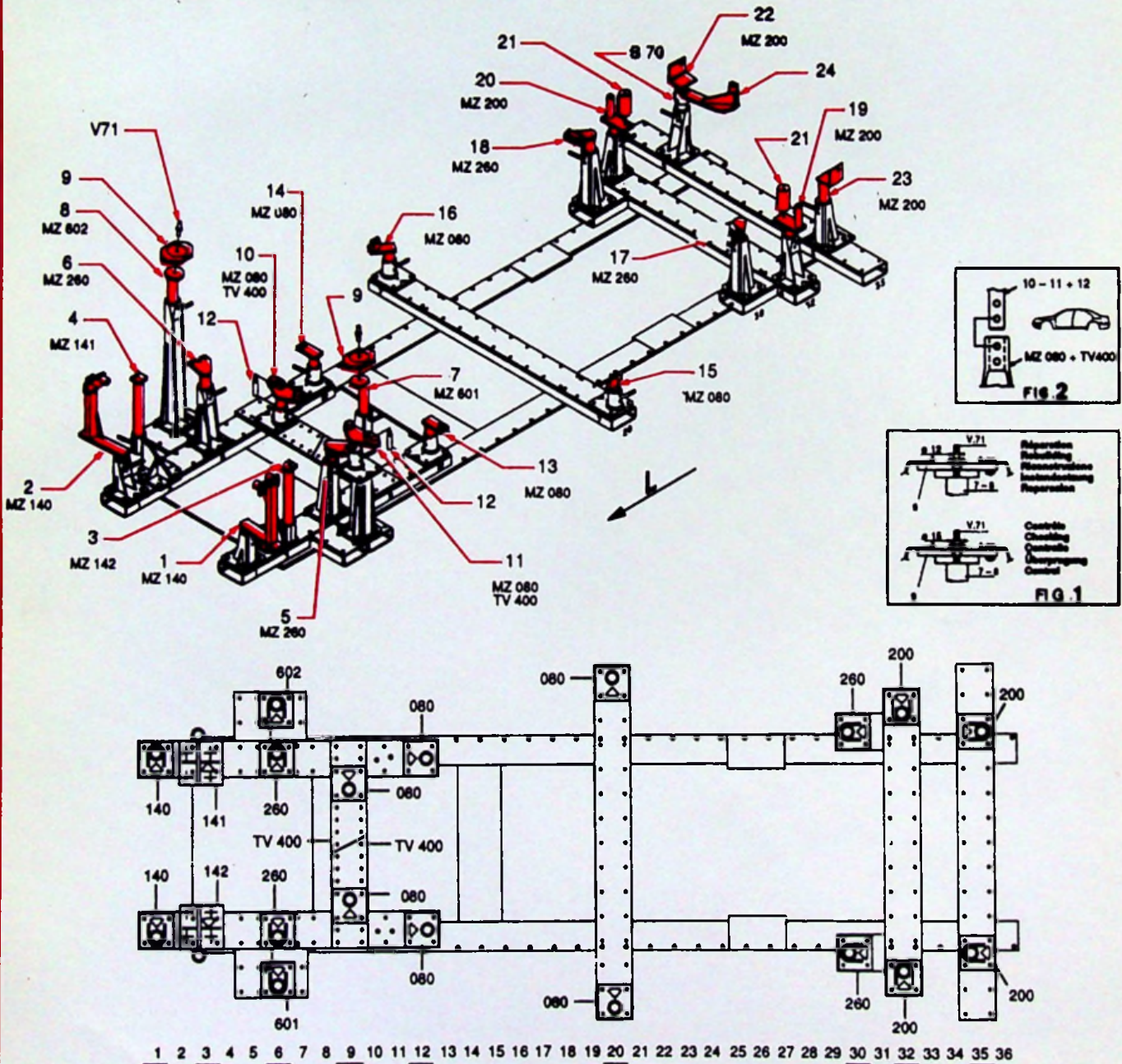



14

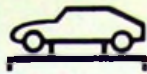

CELETTE

ZX
800-0/2

1

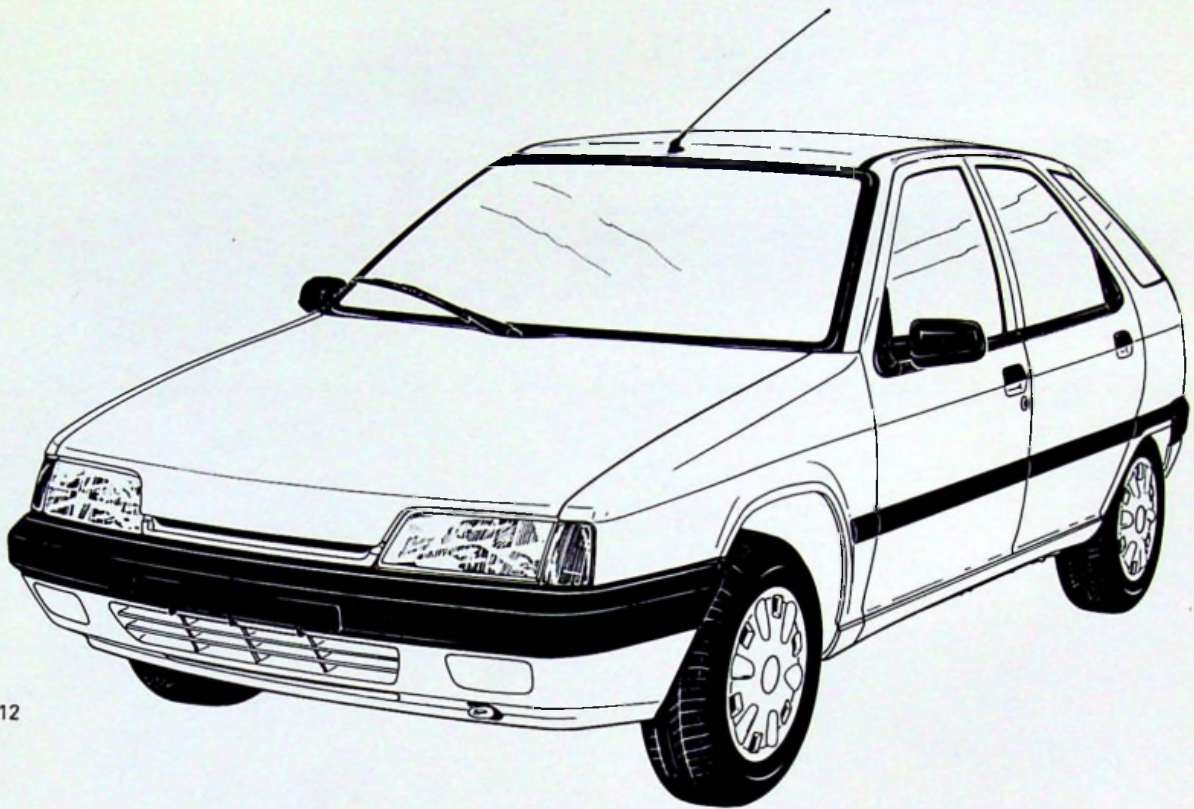

F. 80-12

<p>→ 9 / 78</p> <p>TT 80-10 TT 80-12 TT 80-13 TT 80-14</p>	<p>9 / 78 →</p> <p>TT 80-10 TT 80-12 TT 80-14</p>
--	---



CELETTE MZ

Détails									
Réf. des Détails	MZ080	MZ140	MZ141	MZ142	MZ200	Z260	MZ601	MZ602	TV400
Quantité	6		1	1	4				1

REFERENCE CELETTE 612.300

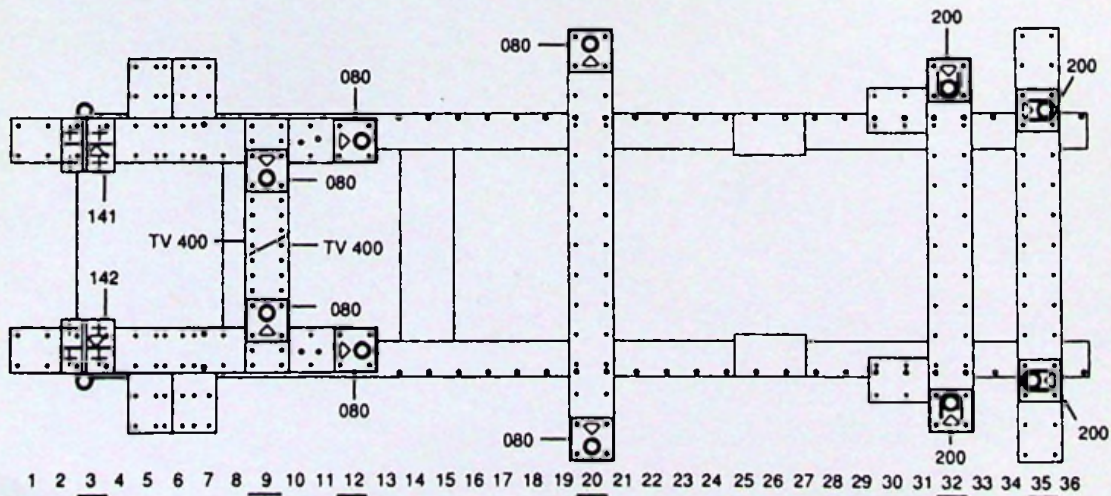
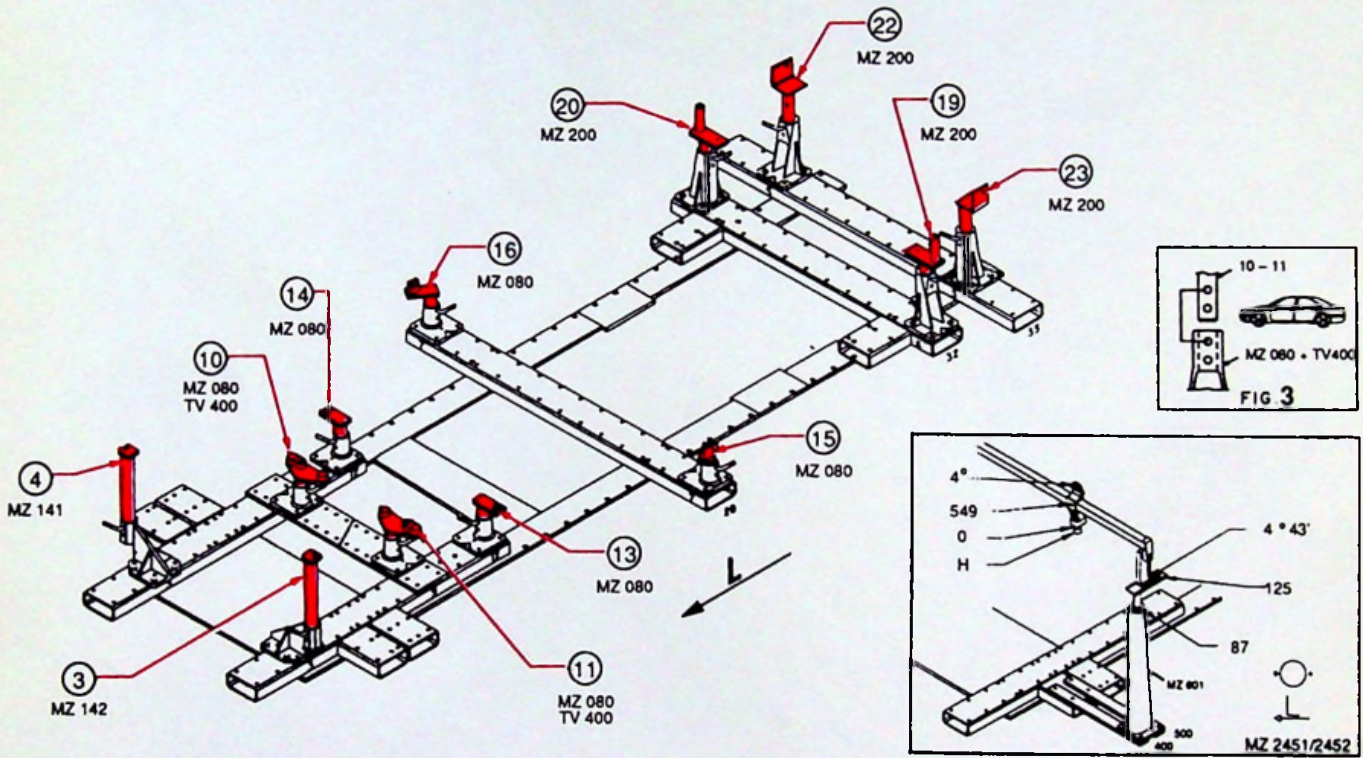



14



ZX
800-0/10

1

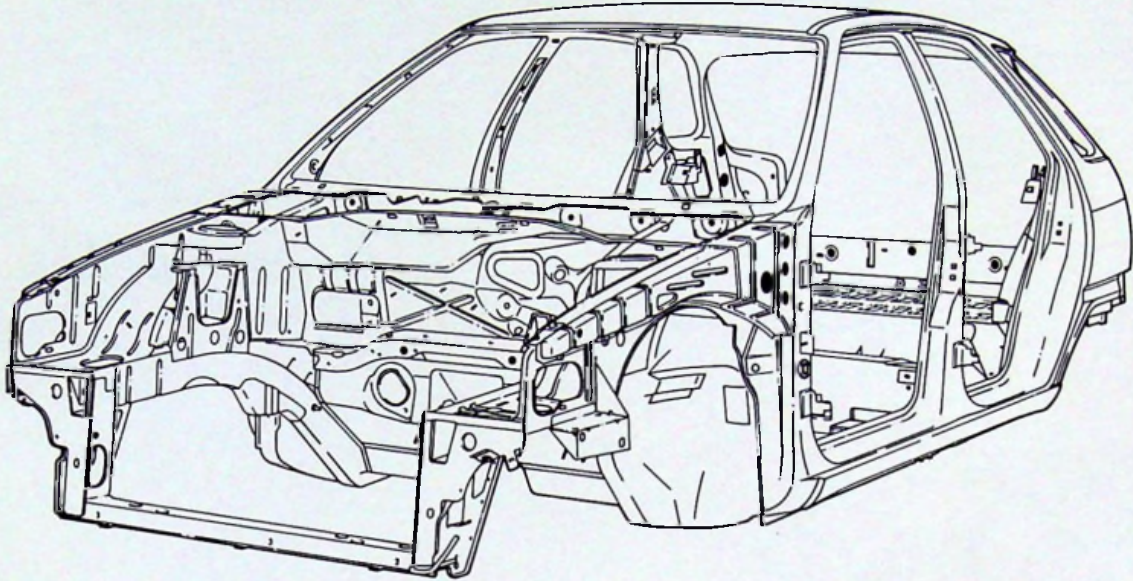

F. 80-10

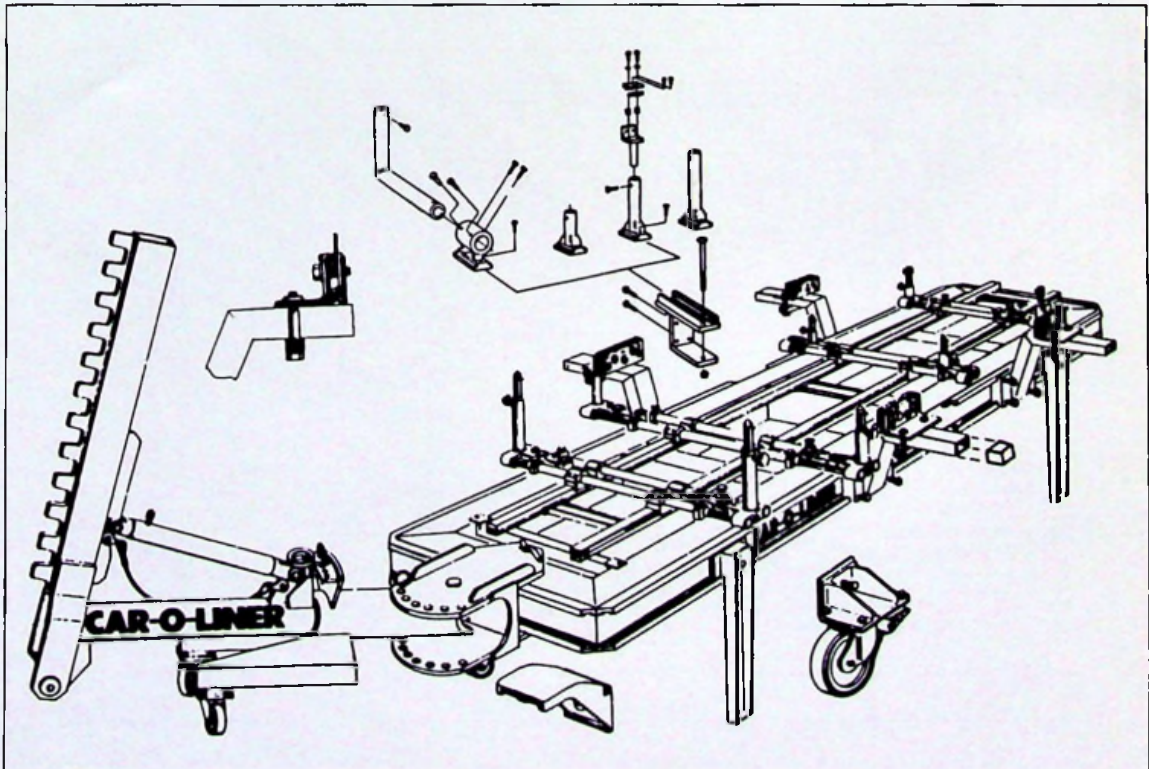

TT. 80-9

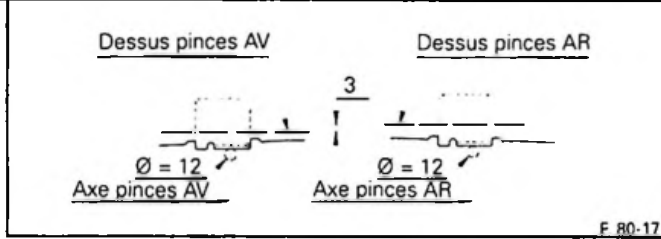
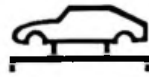

N.B. les vis utilisées n'ont pour but que le centrage des embouts.

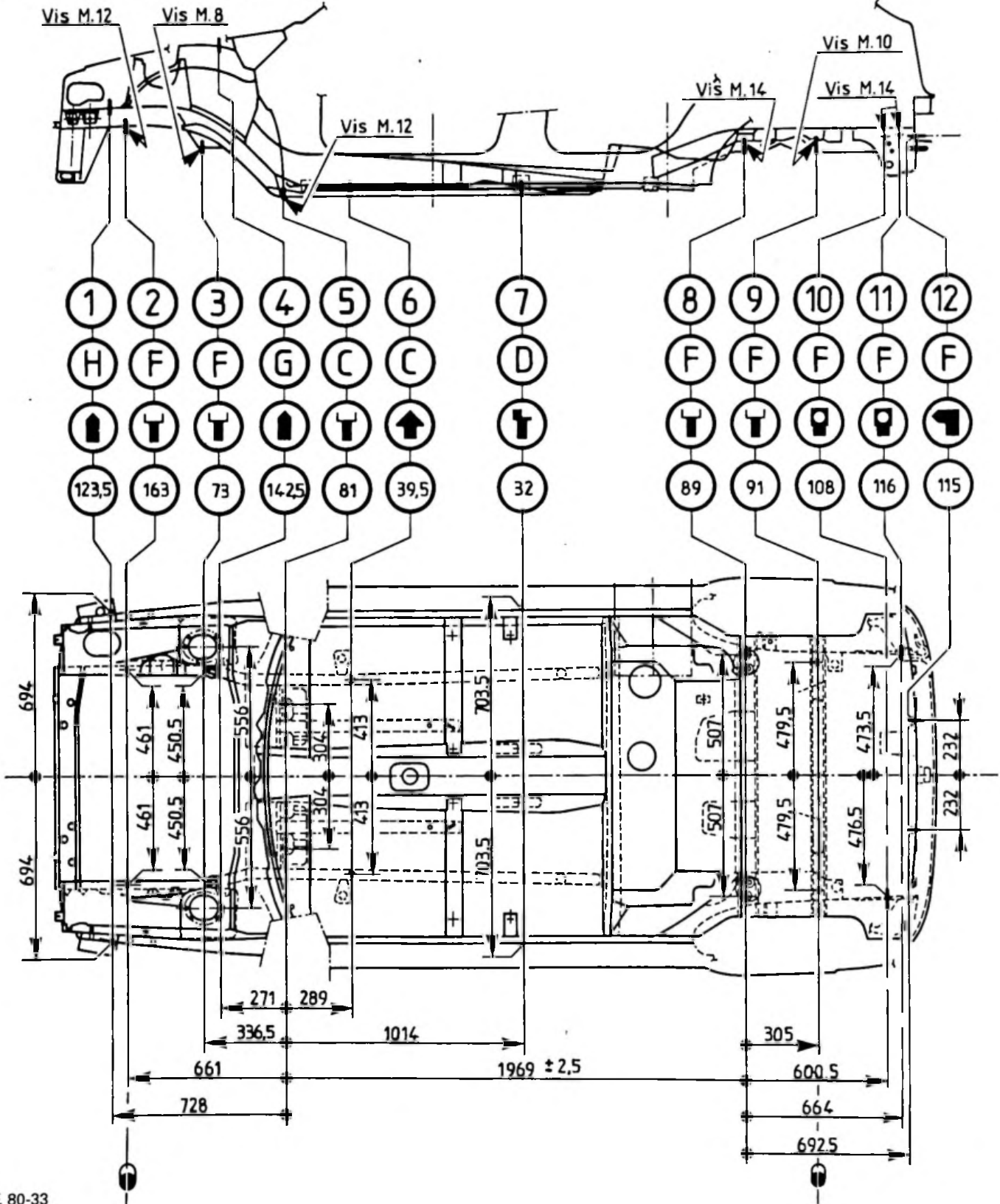



14



ZX
800-0/10

3

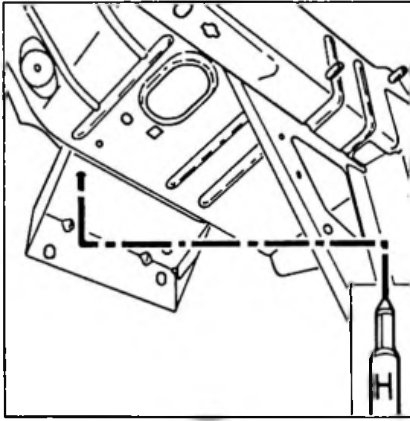

1

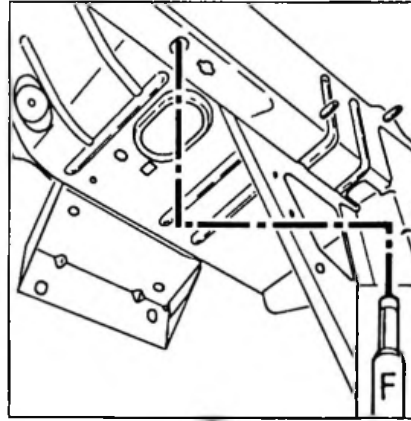

2

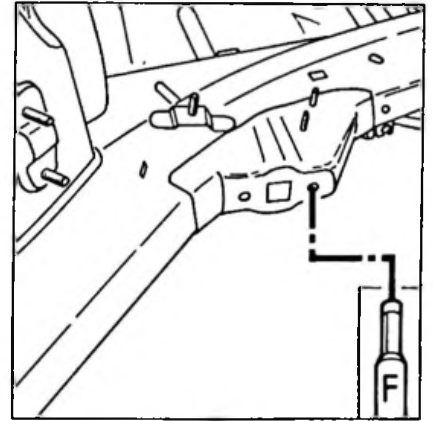

3

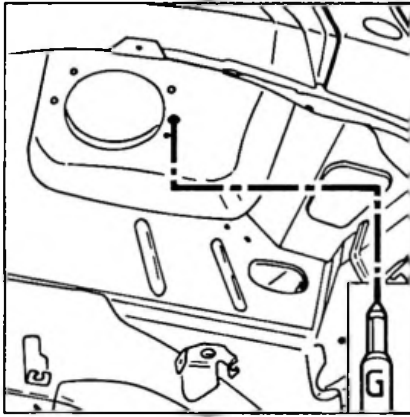

4

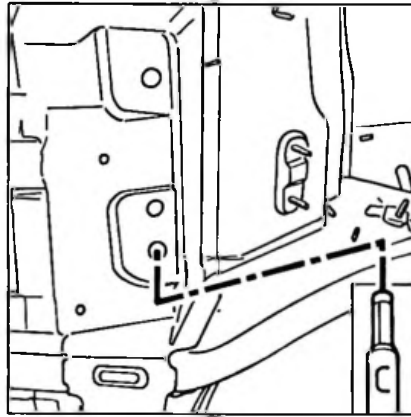

5

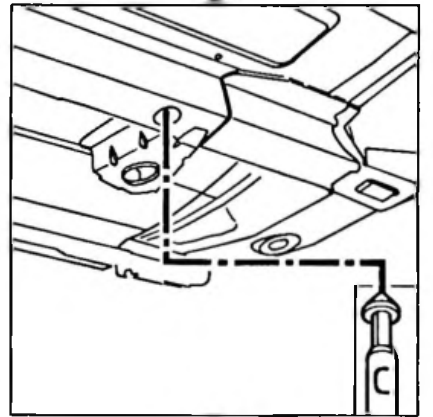

6

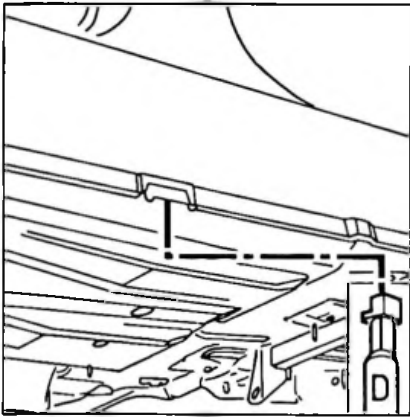

7

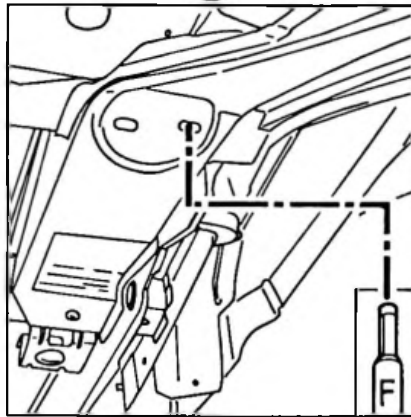

8

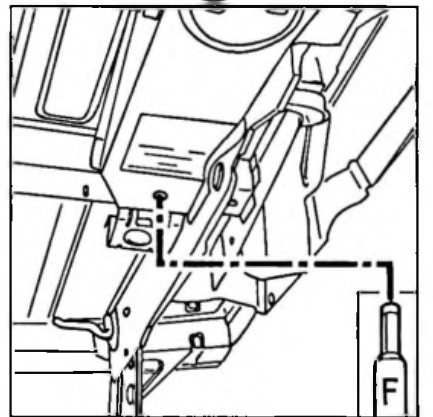

9

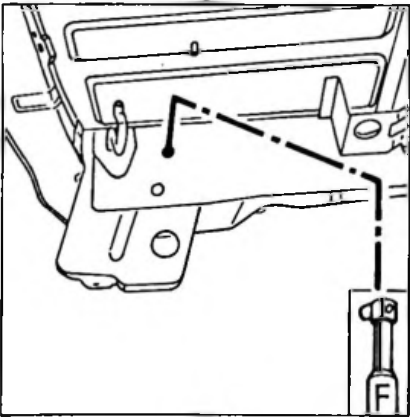

10

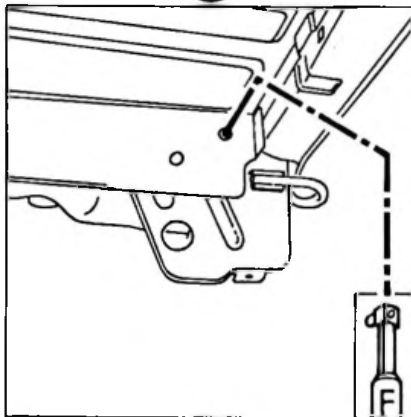

11

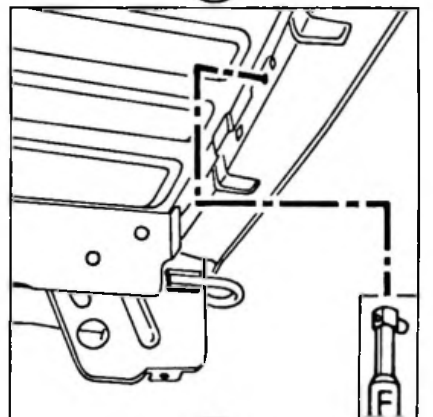

12



14



ZX
800-0/11

1

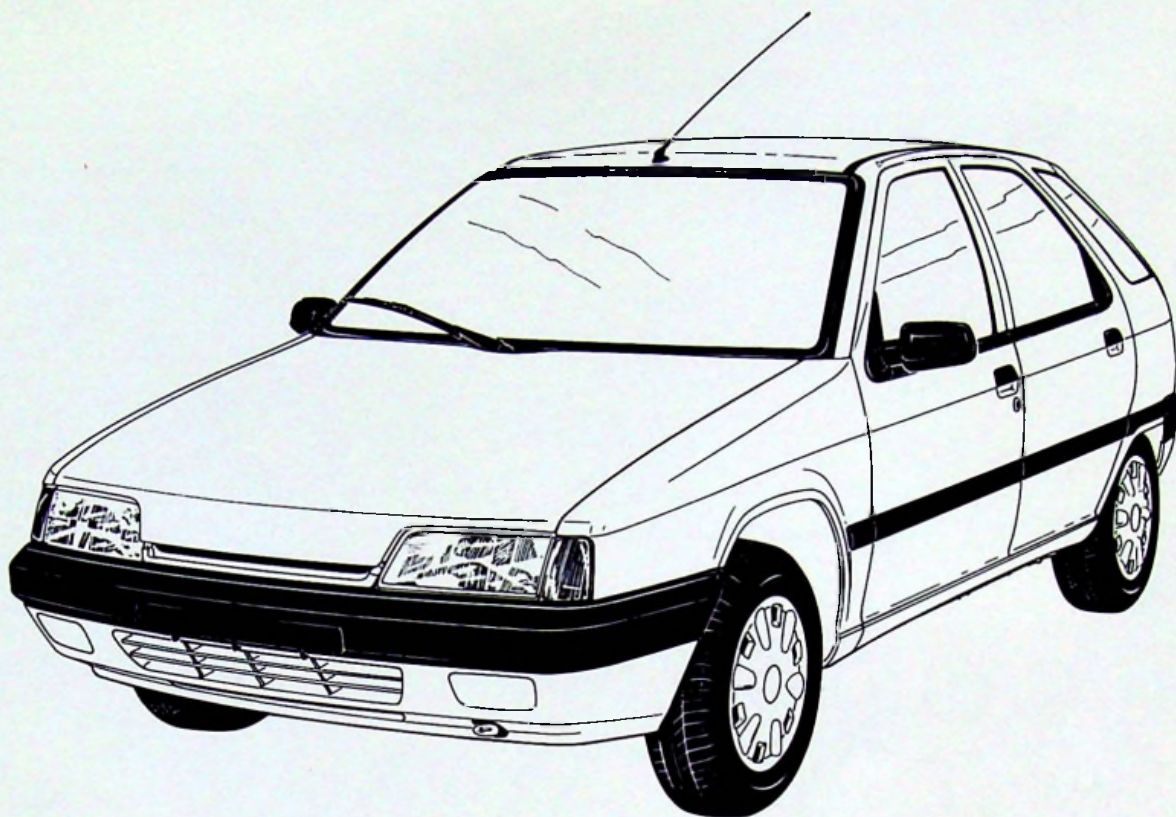

F. 80-12

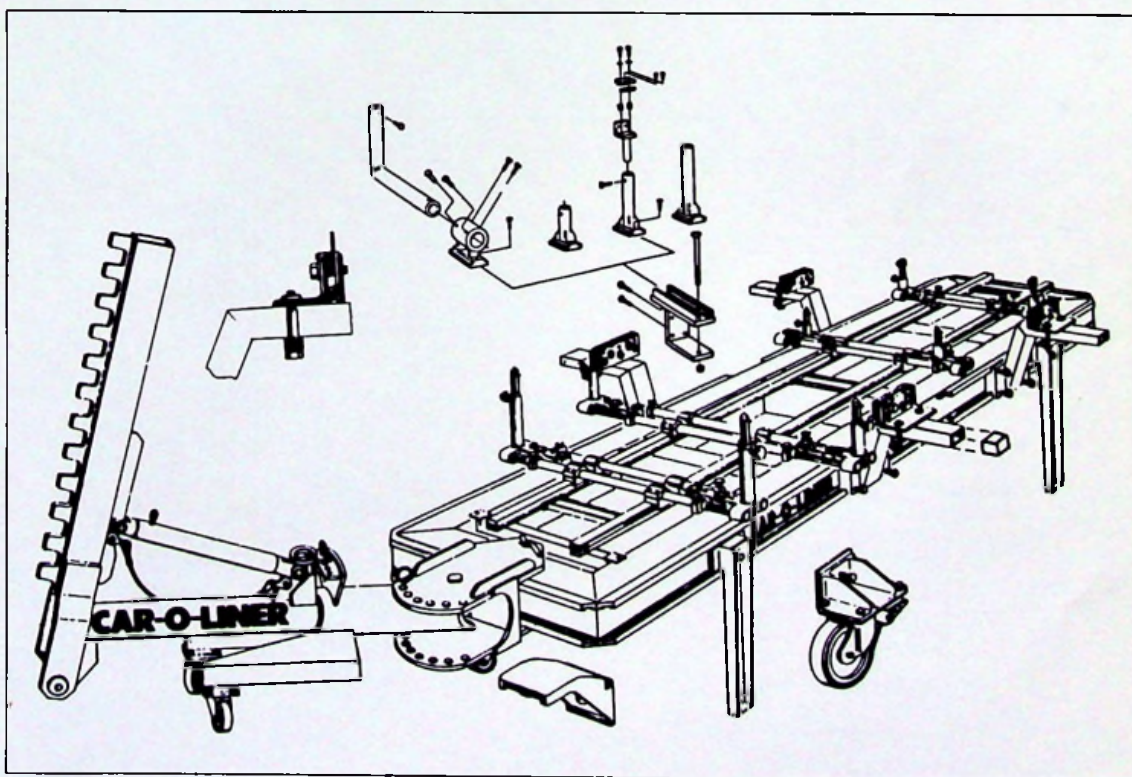

TT. 80-9

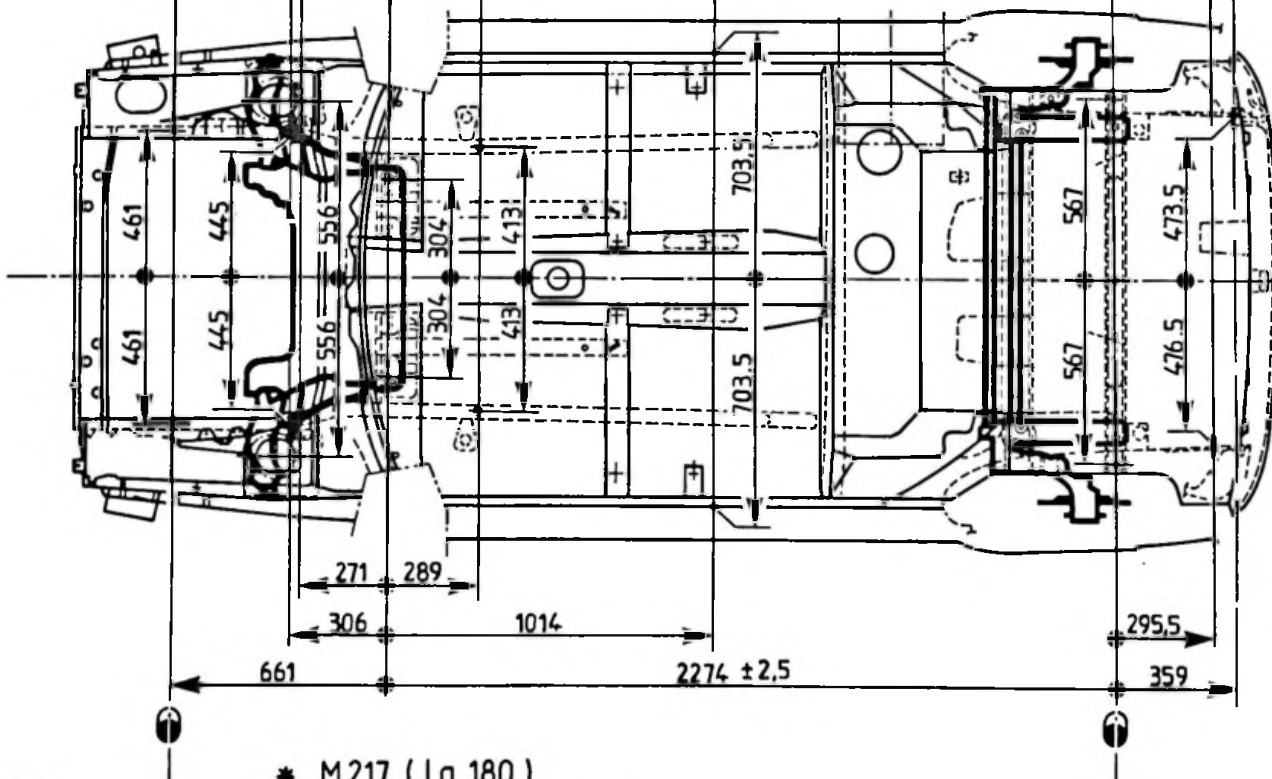
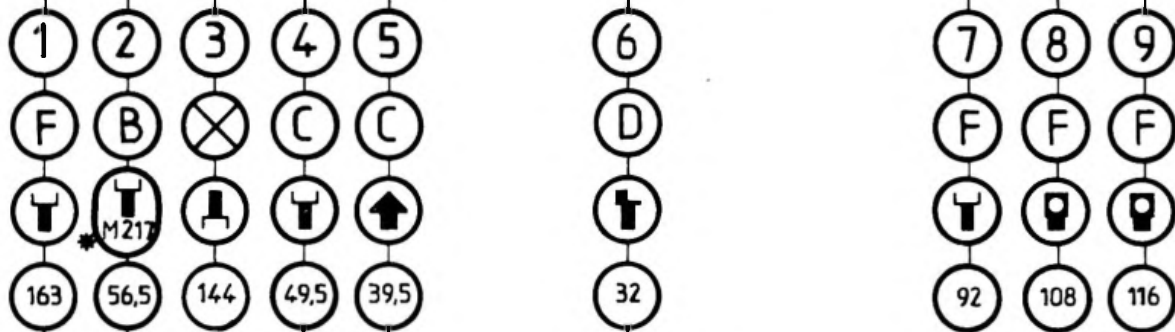
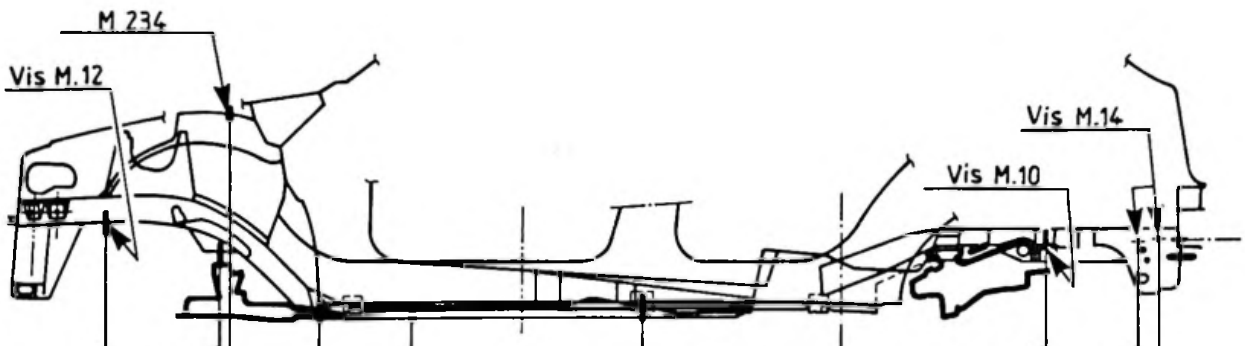
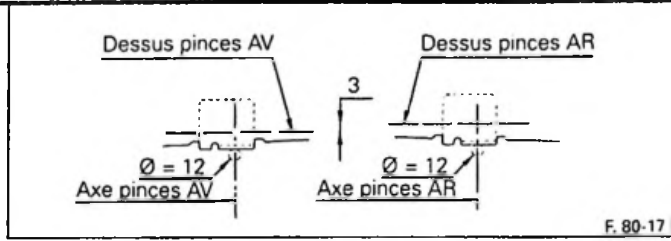

* M217 (Lg.180)



14

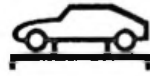

ZX
800-0/11

3

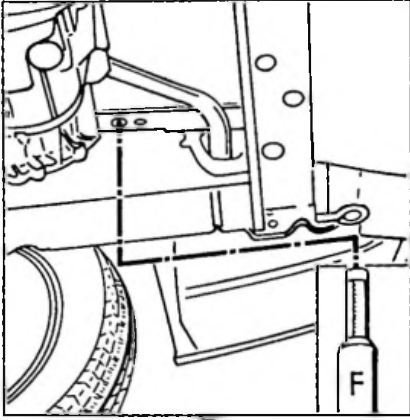

1

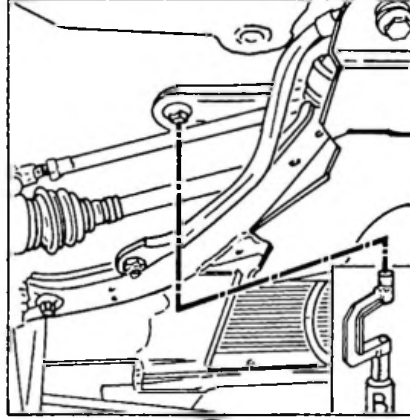

2

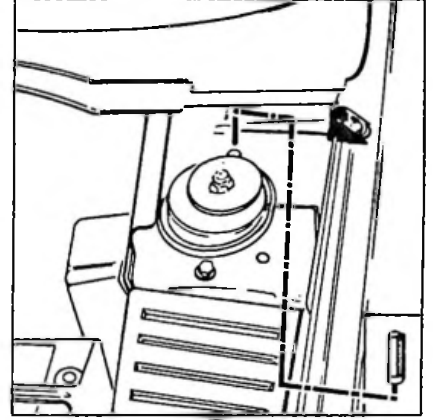

3

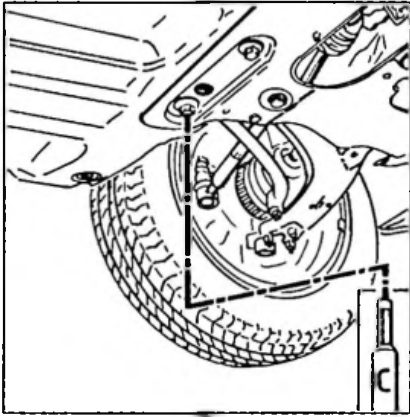

4

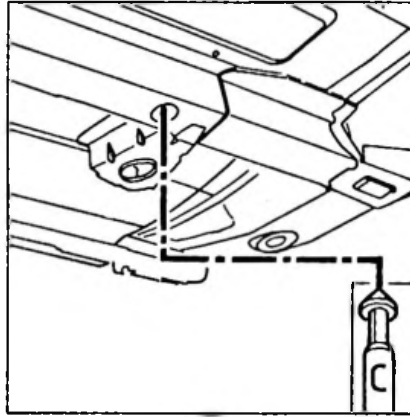

5

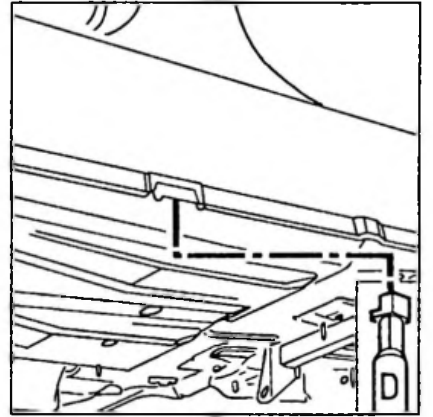

6

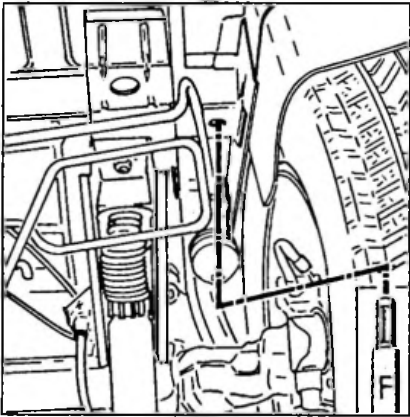

7

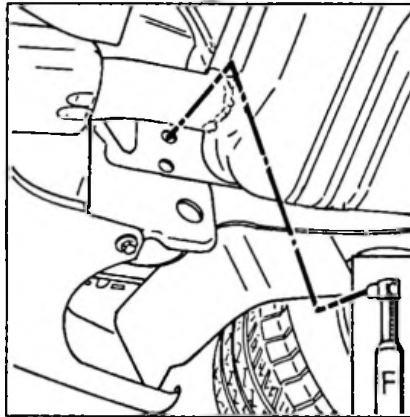

8

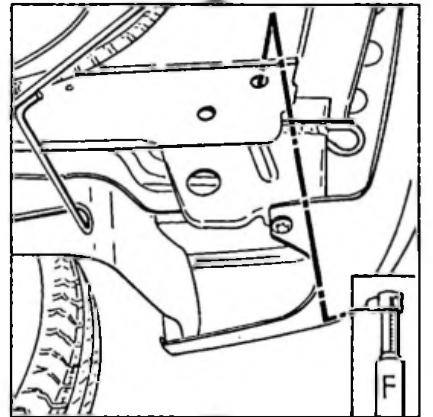

9



14

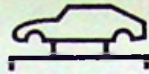

CELETTE
METRO 2000

ZX
800-0/20

1

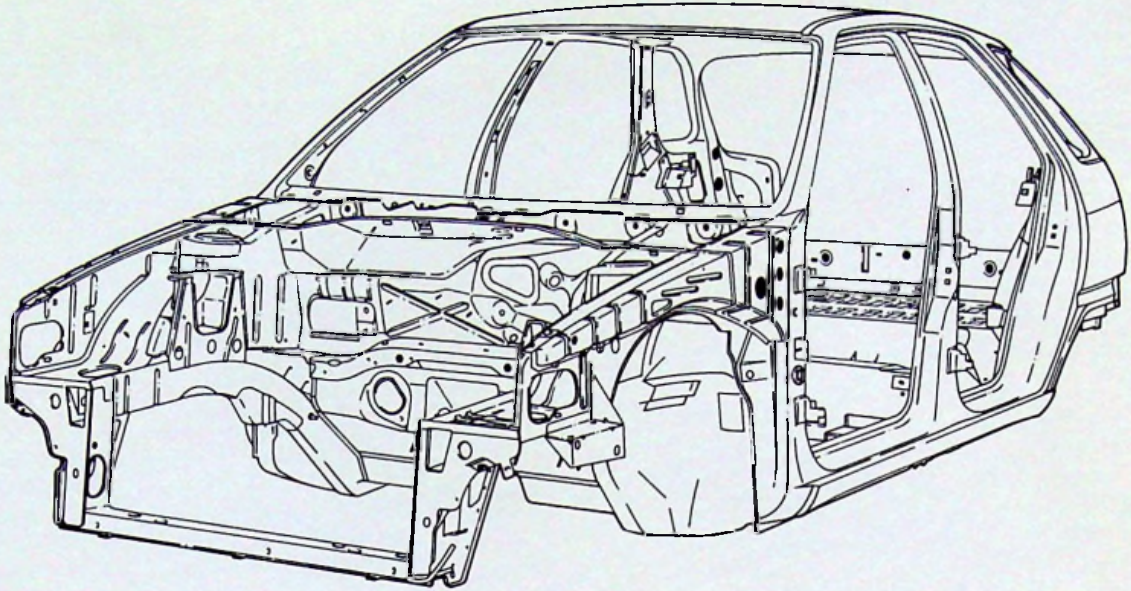

F. 80-10

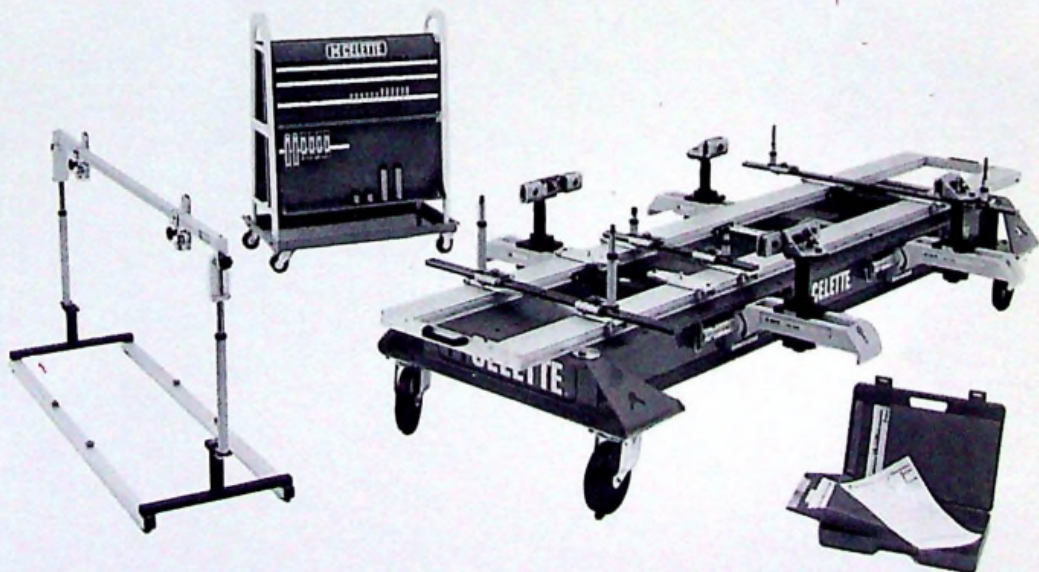

86-798

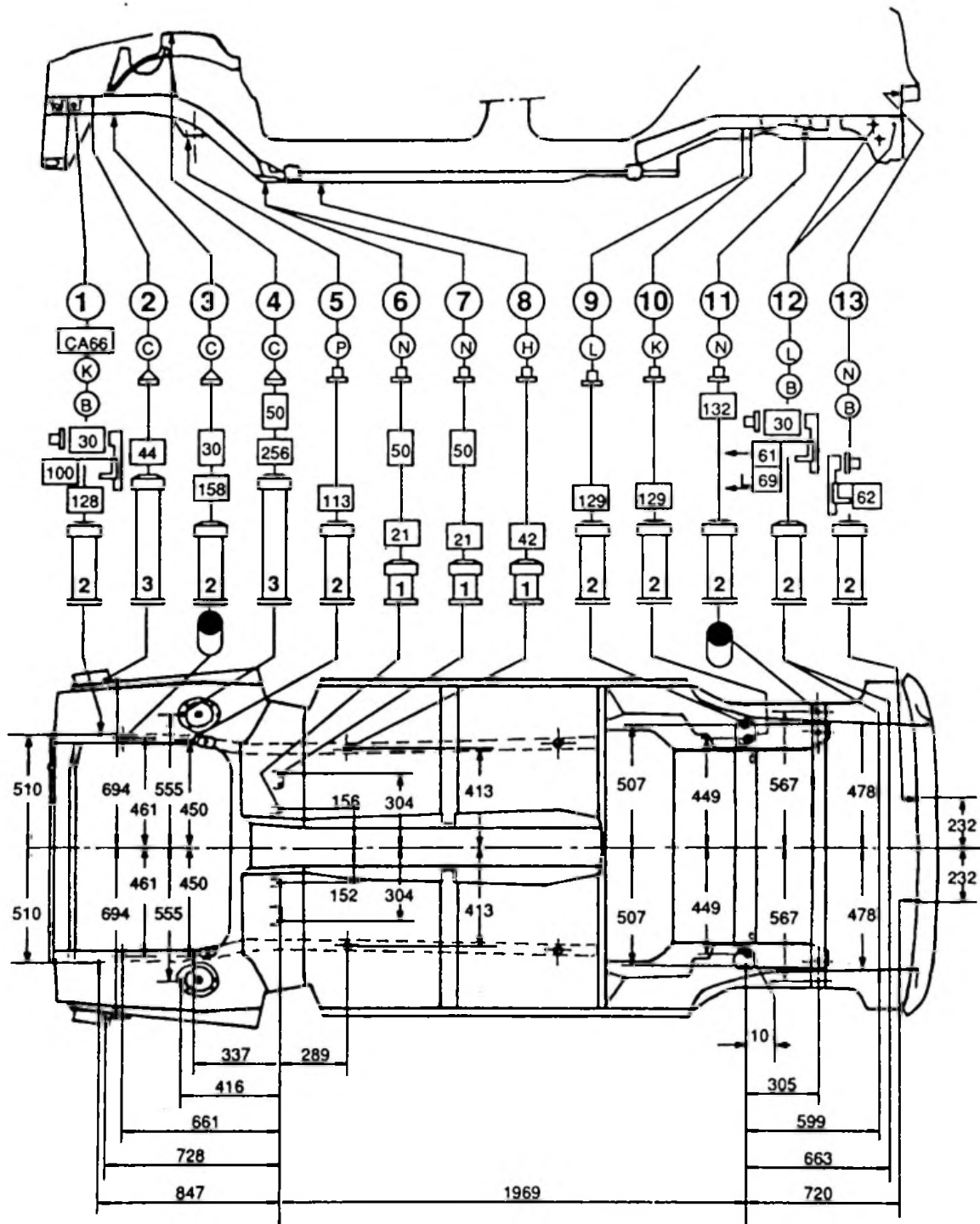
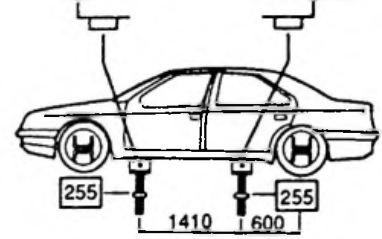
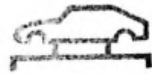



14

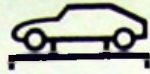

CELETTE
METRO 2000

ZX
800-0/21

1

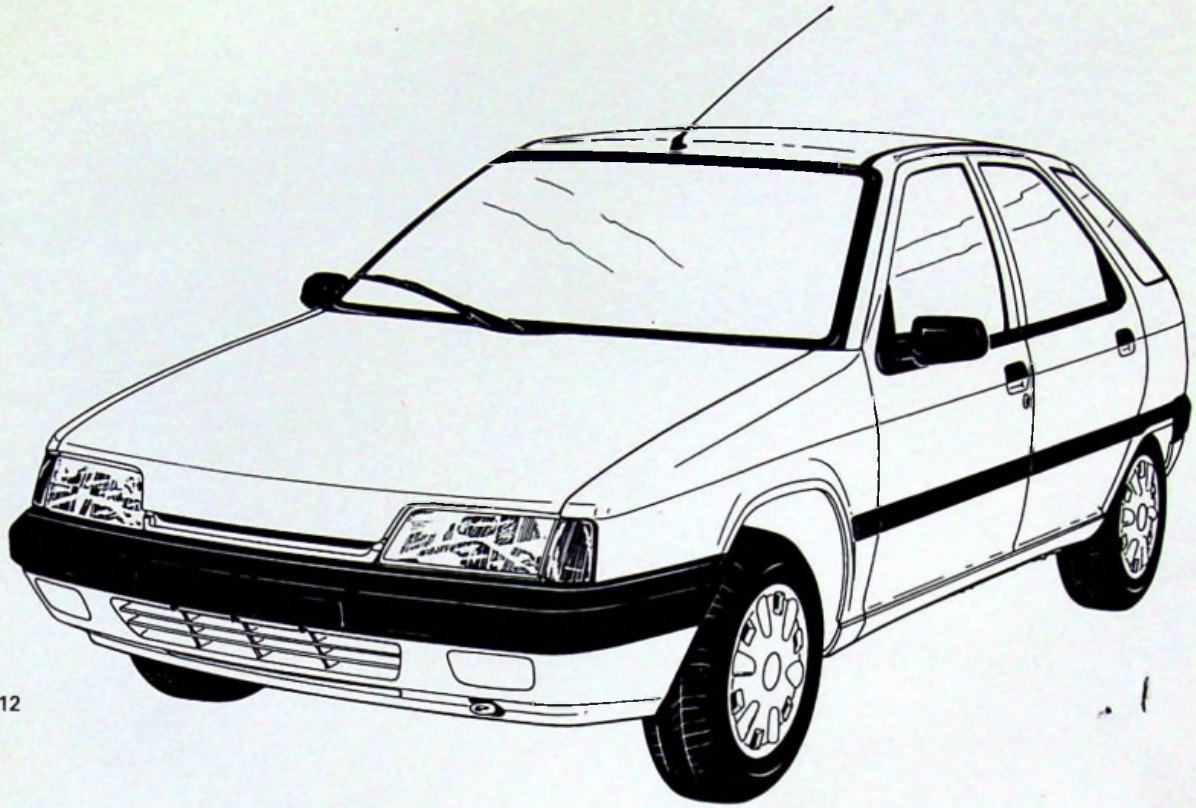

F. 80-12

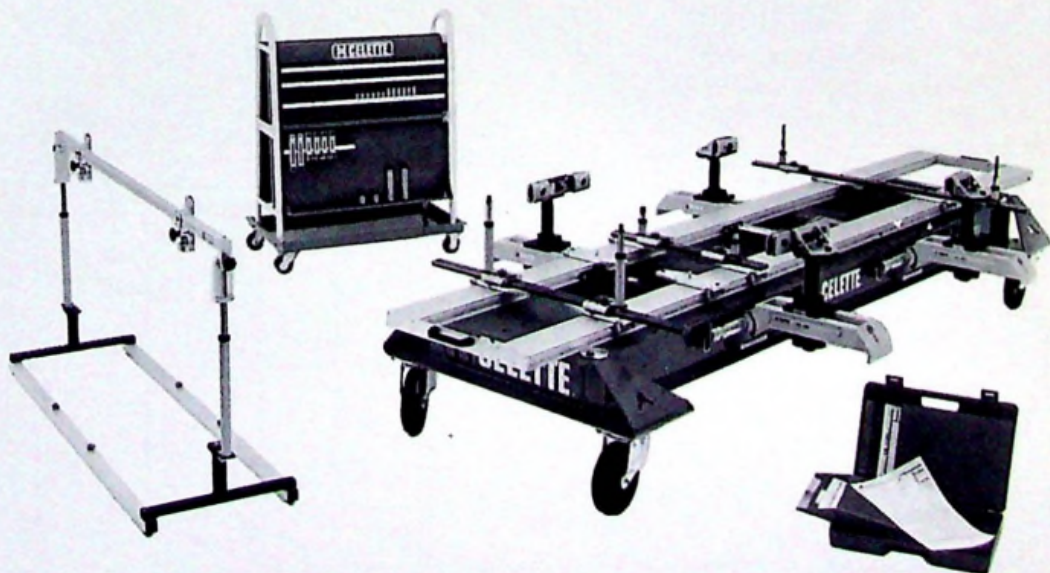

86-798

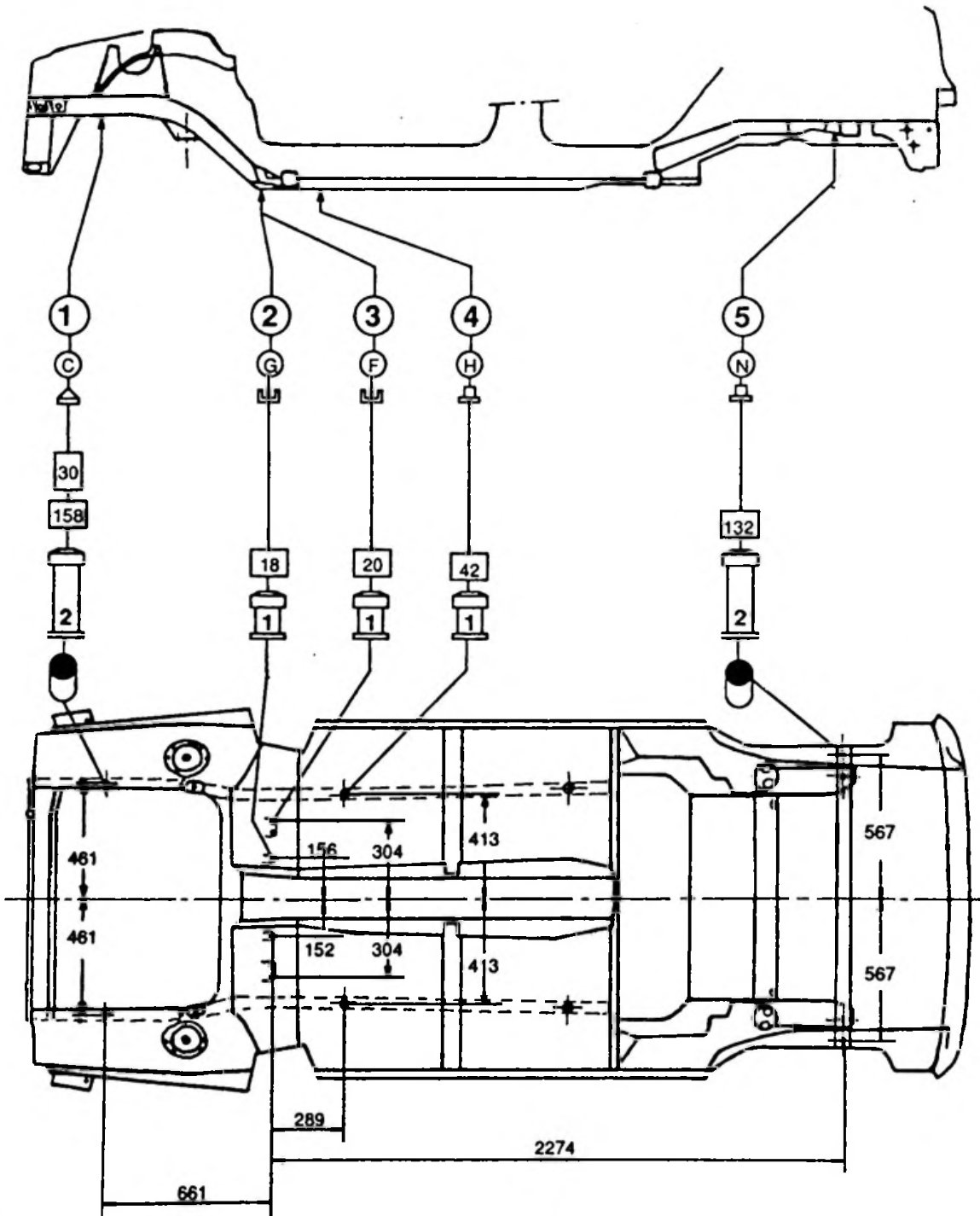
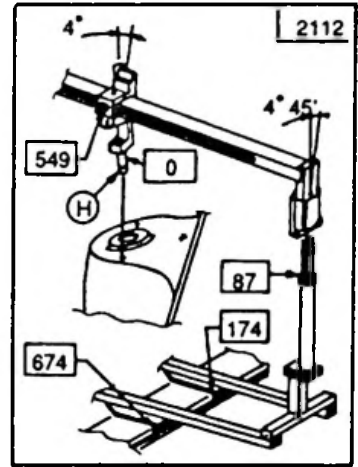



14



ZX
801-3/1

1

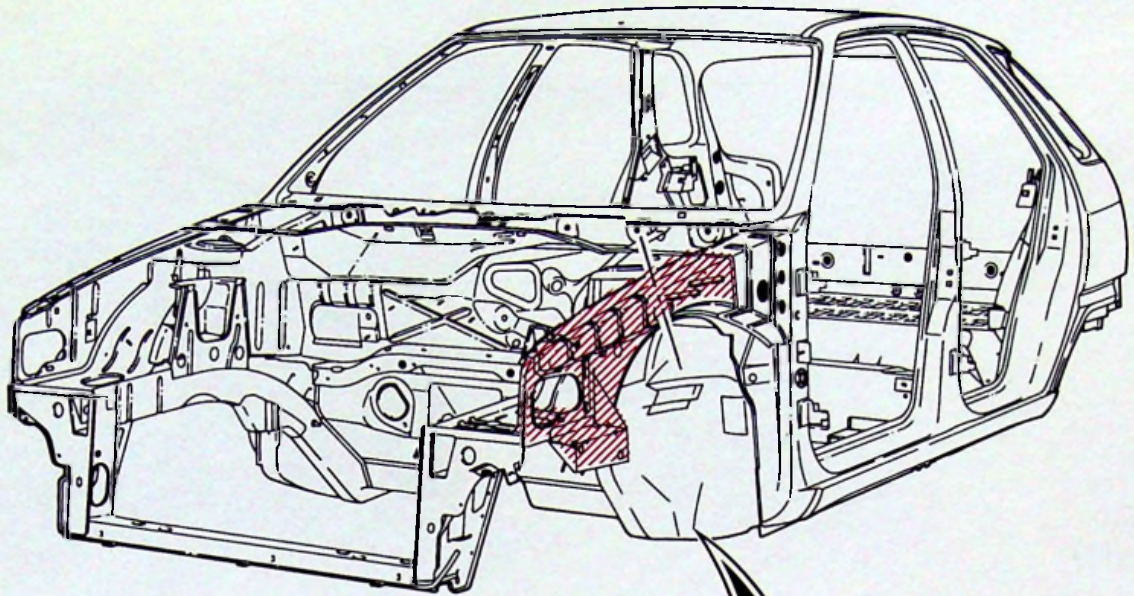

F.80-10

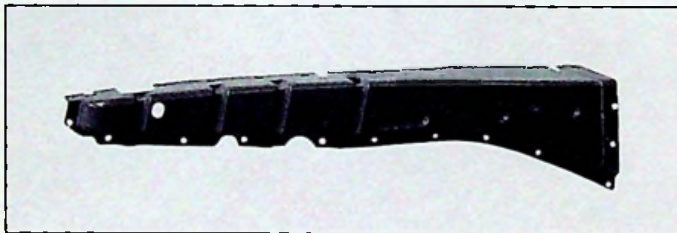

90-1118

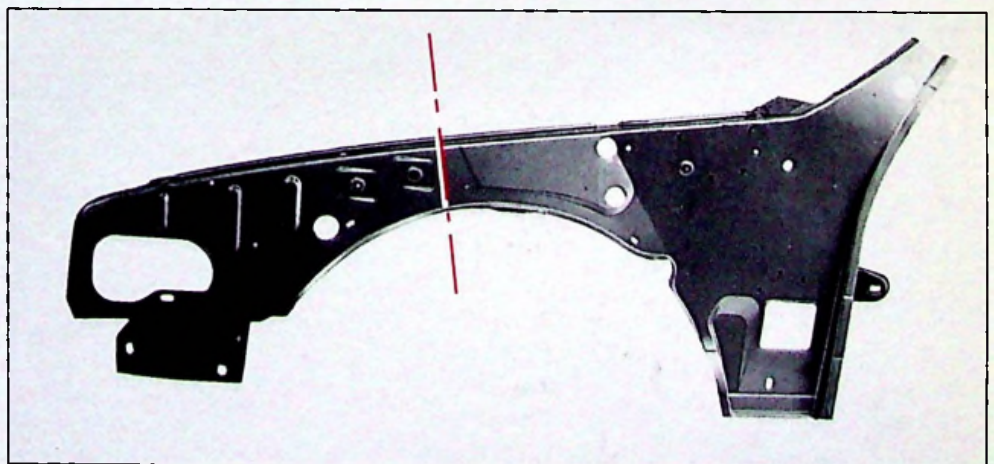

90-1133

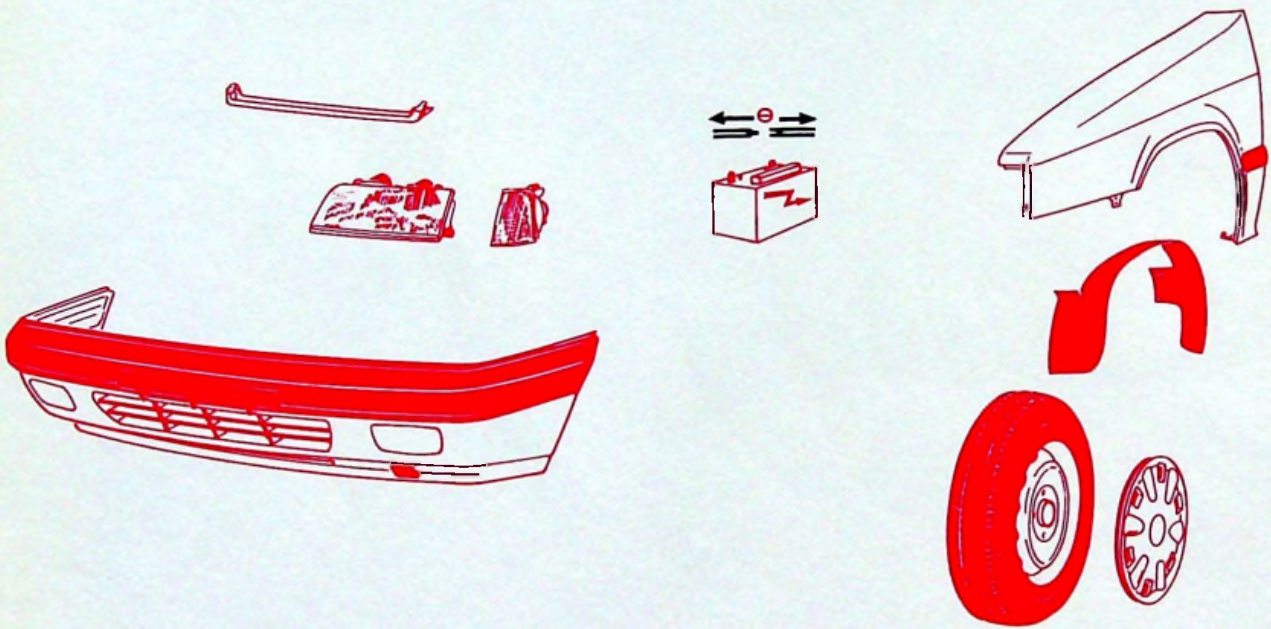
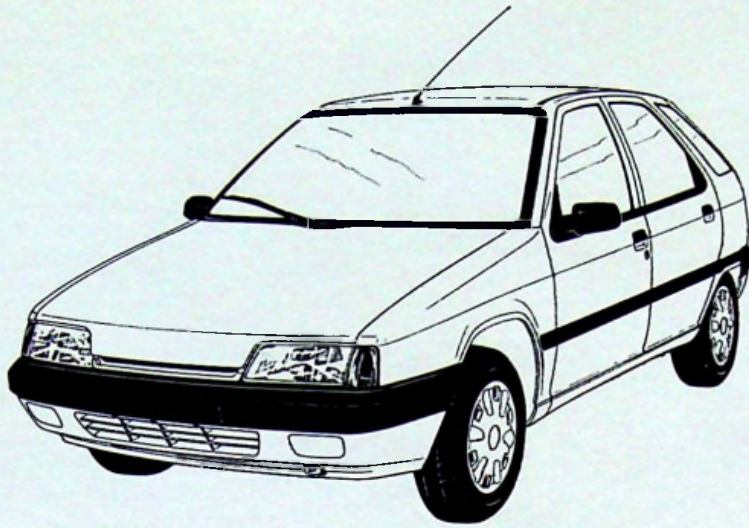
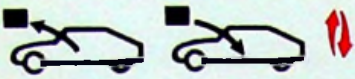



14



ZX
801-3/1

3

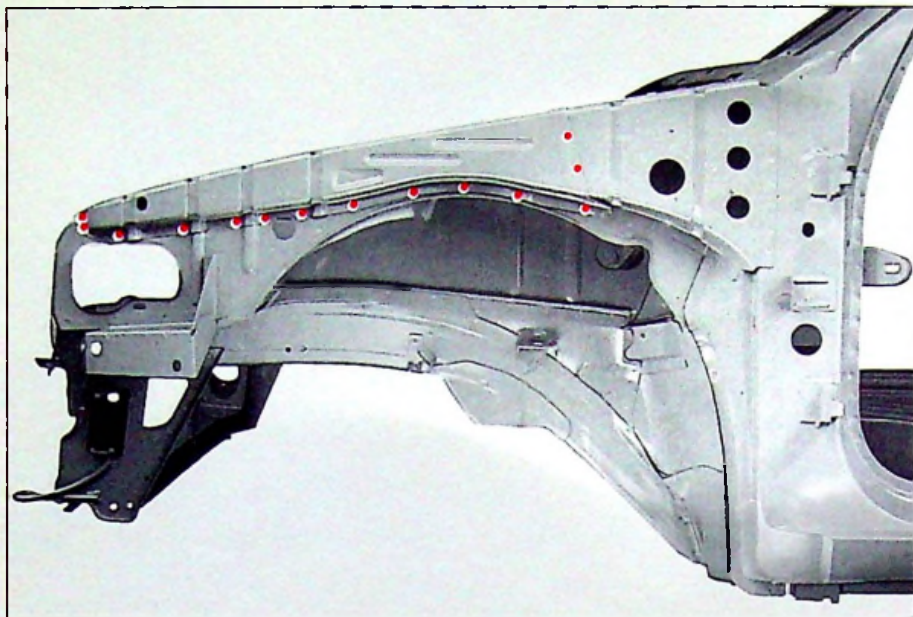
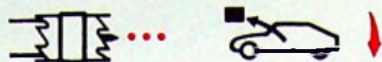

90-1085

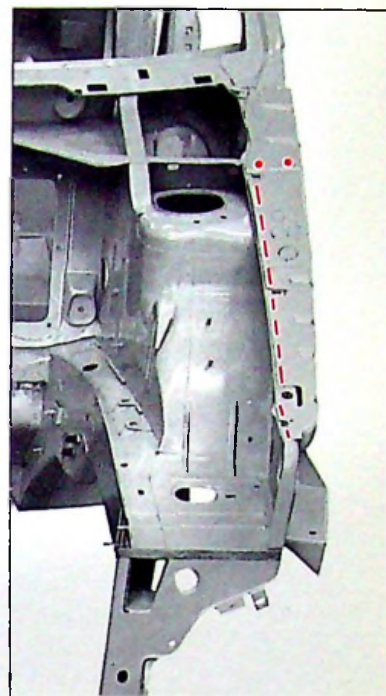

90-1094

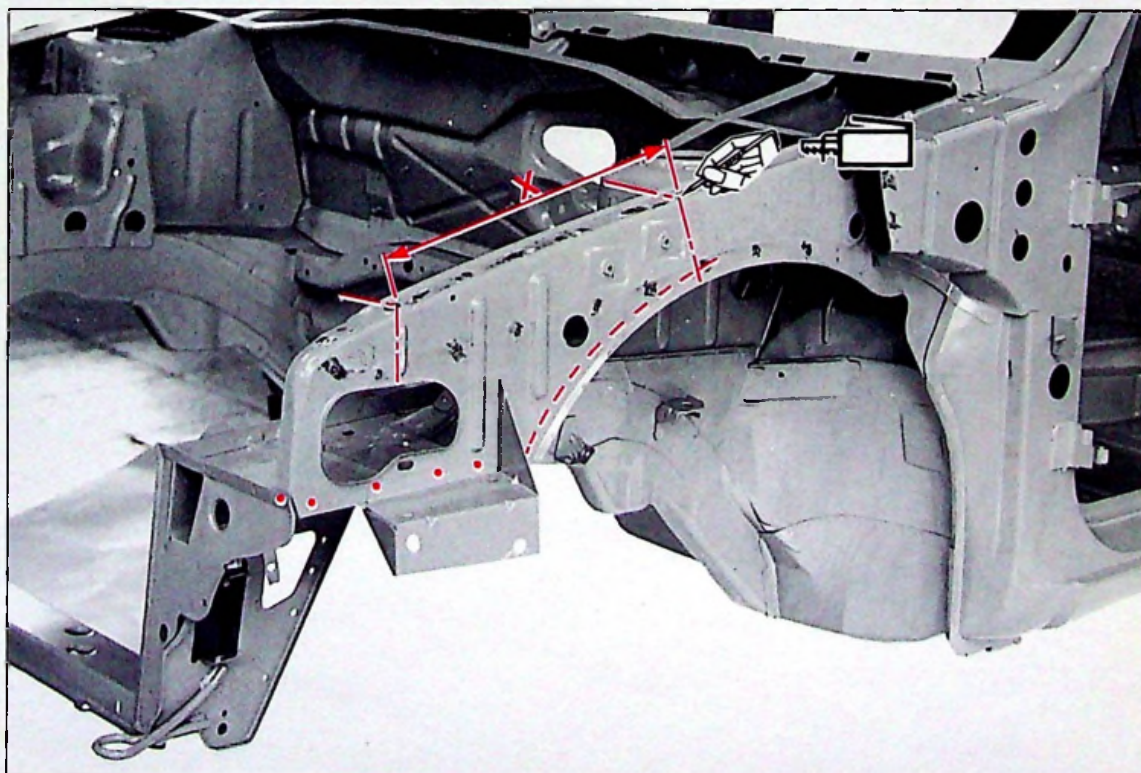
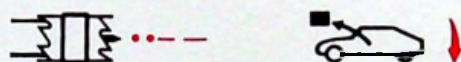

90-1182

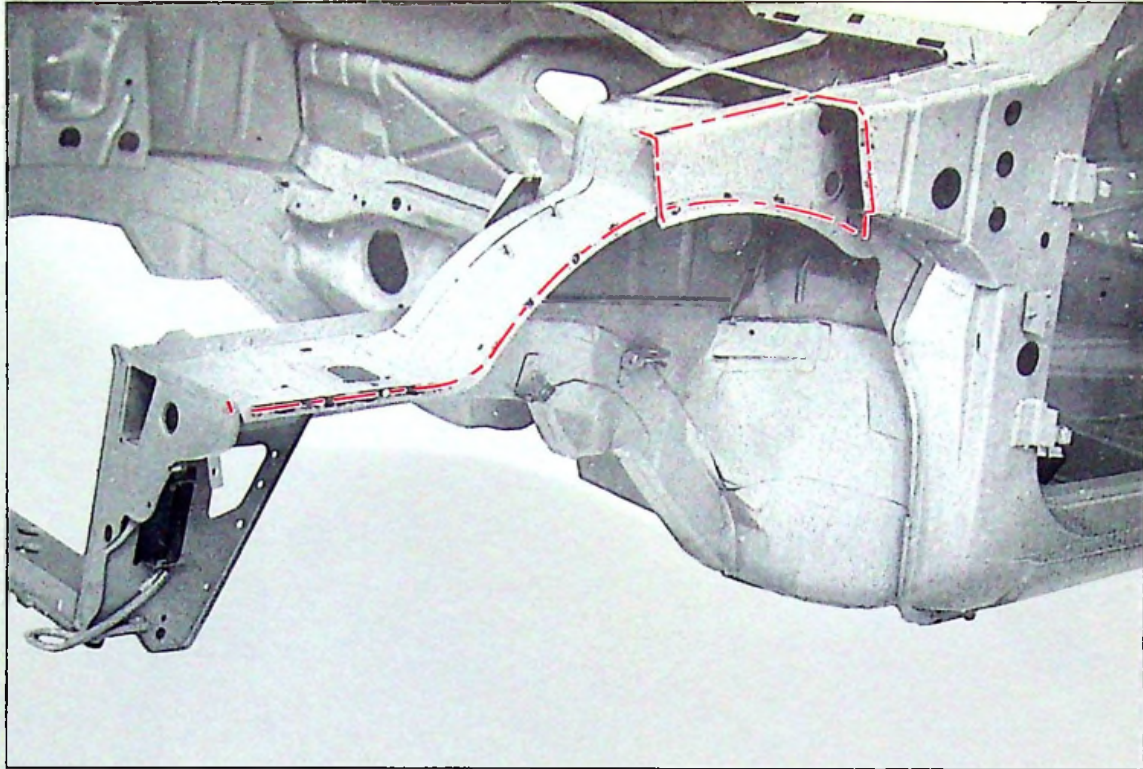

90-1183

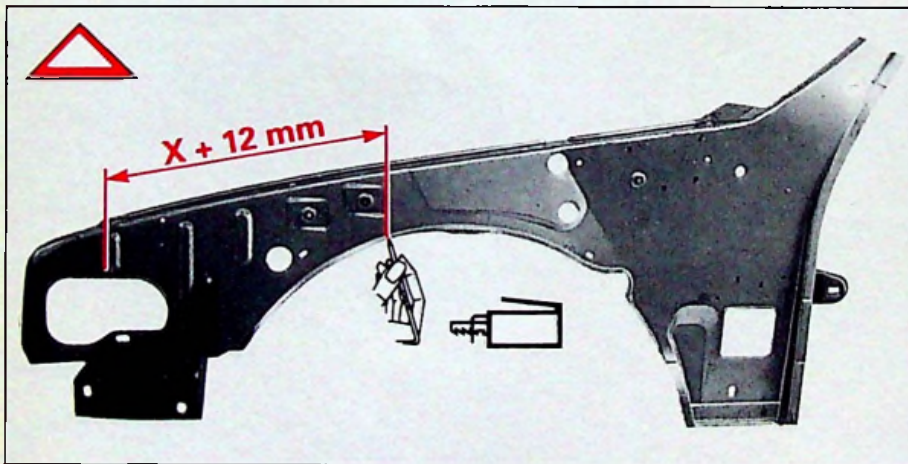

90-1133

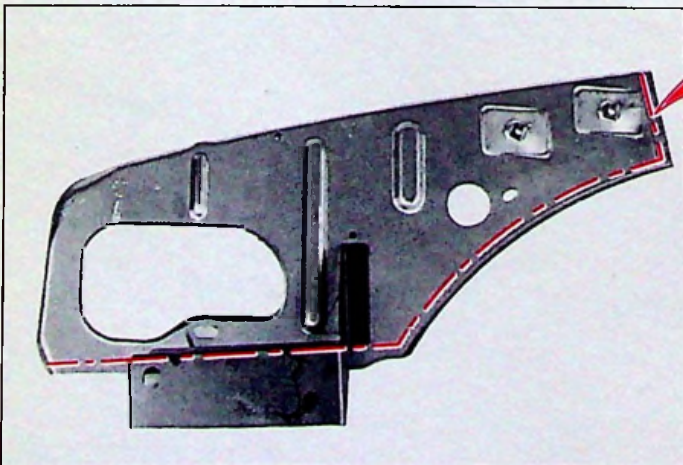

90-1205

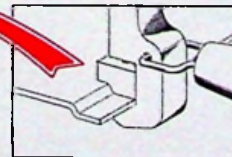

TT.80-17





14



ZX
801-3/1

5



90-1118

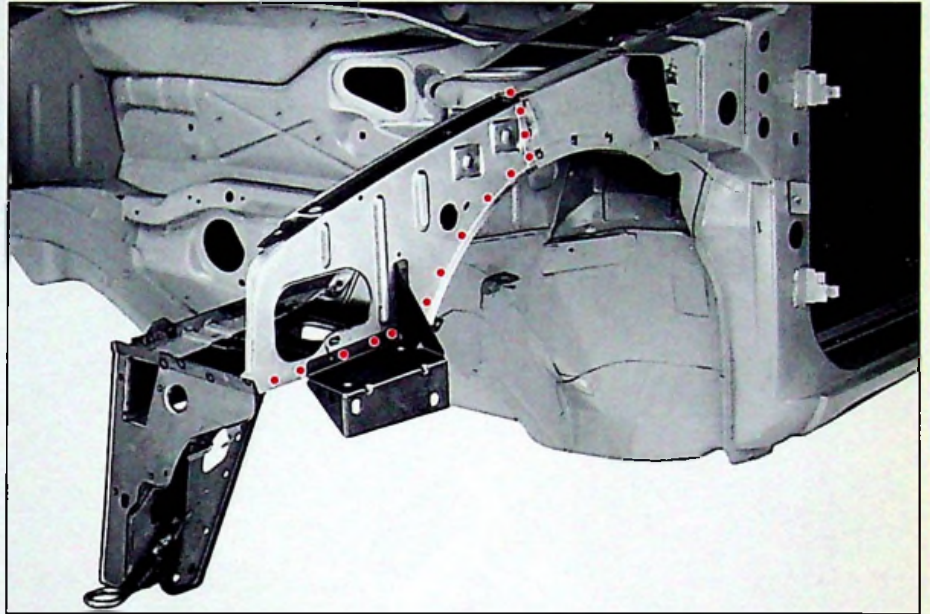
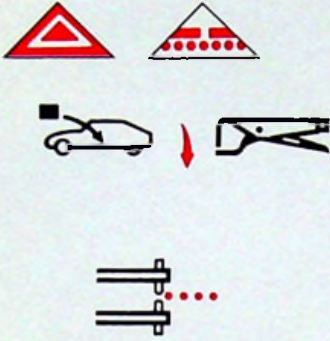

90-1213

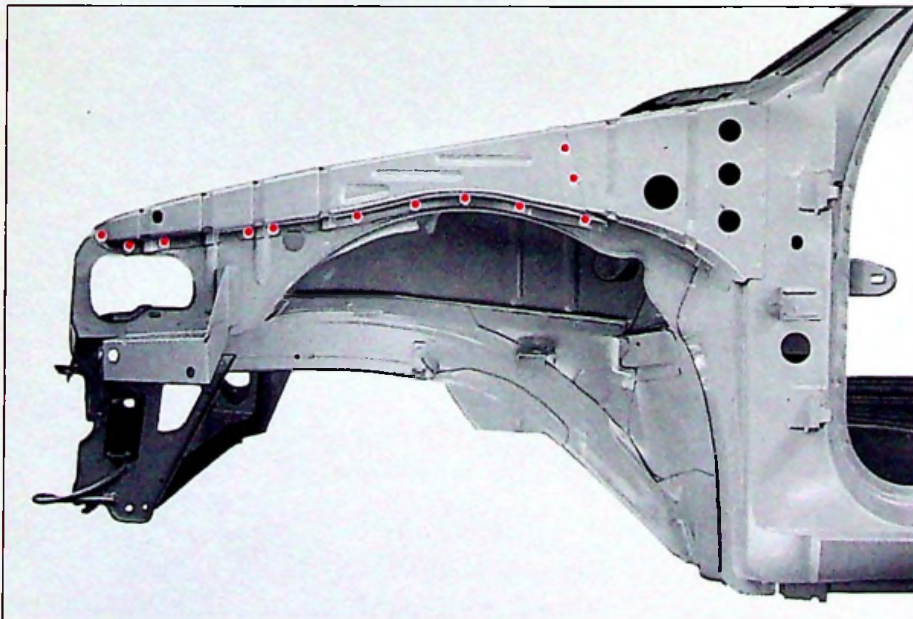

90-1085

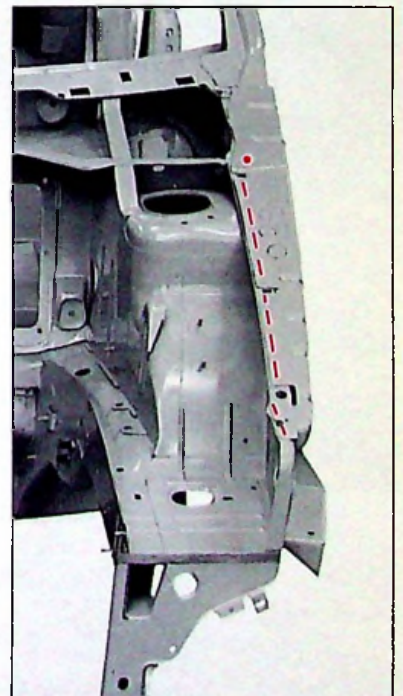

90-1094



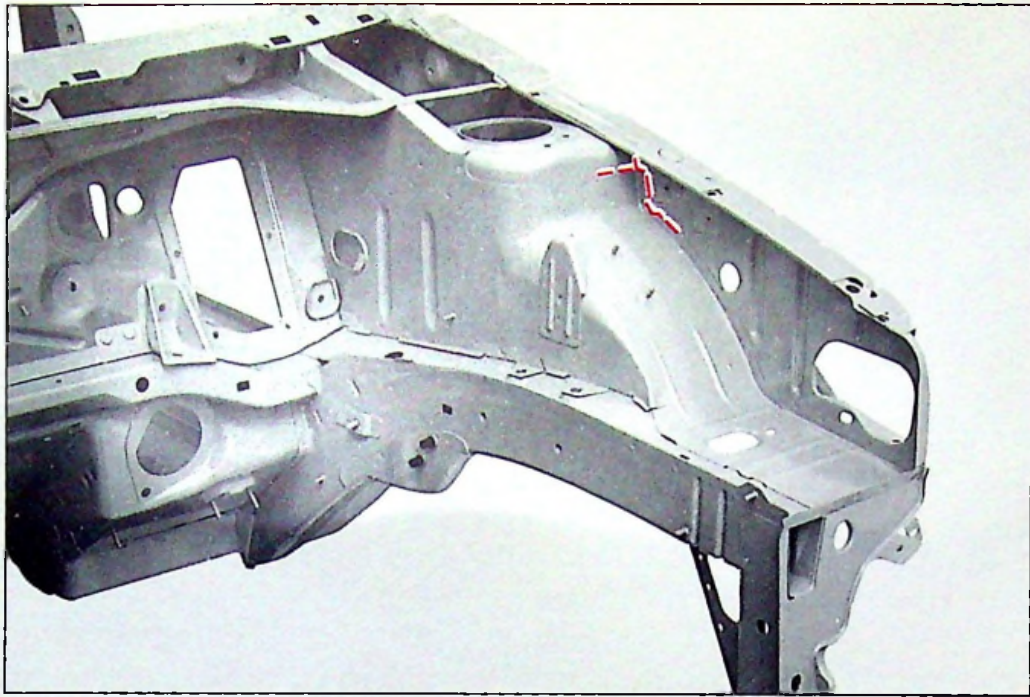

90-1104



A1



ZX 800-00/3



ZX 000-00/5

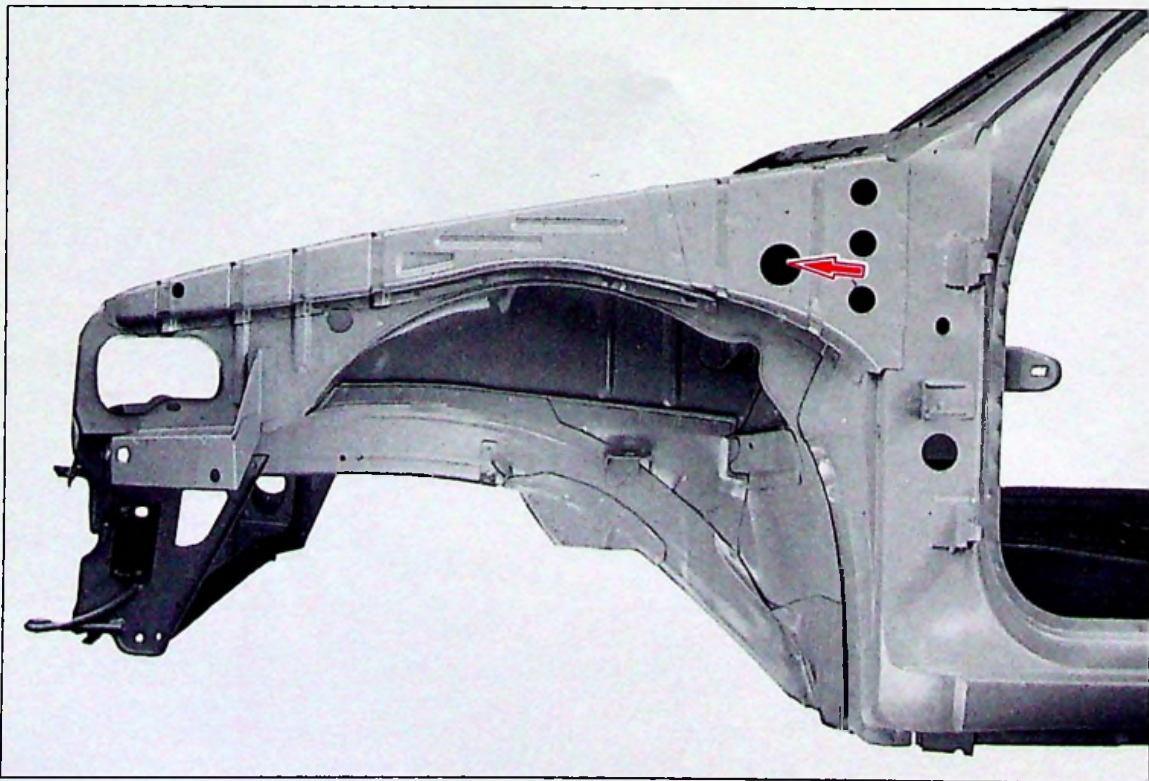

90-1085



14

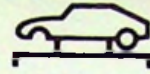

ZX
801-3/2

1

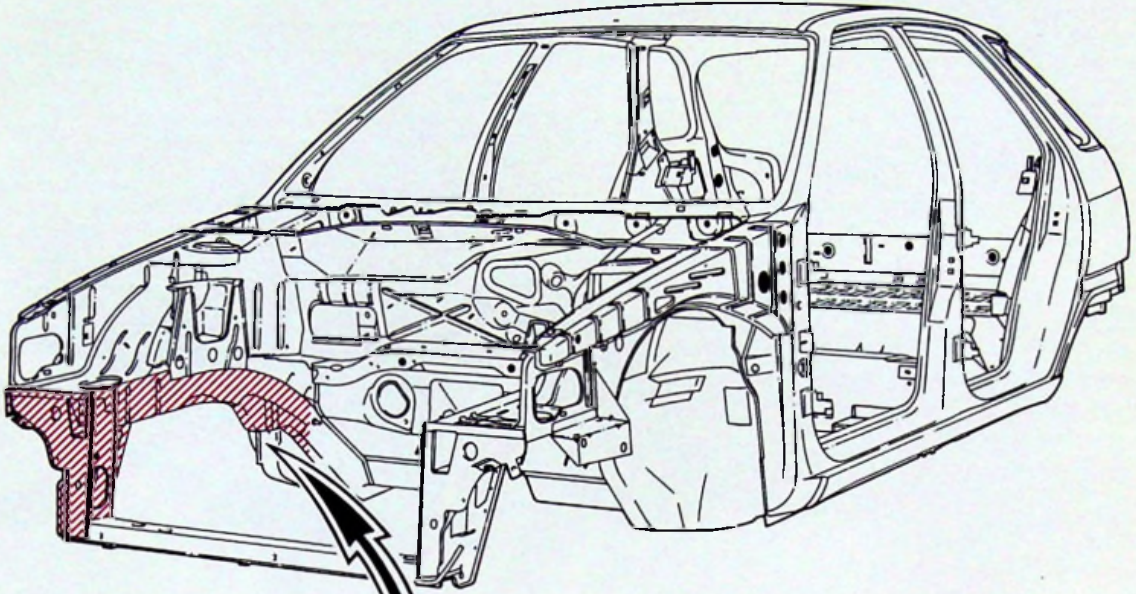

F.80-10

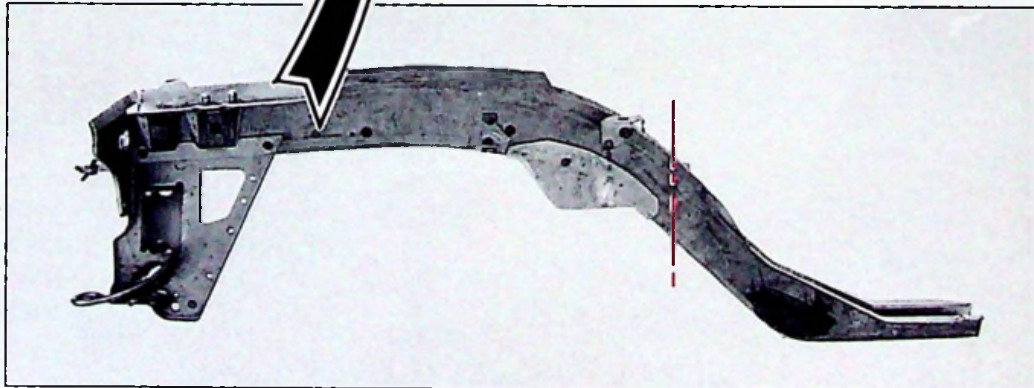

90-1121

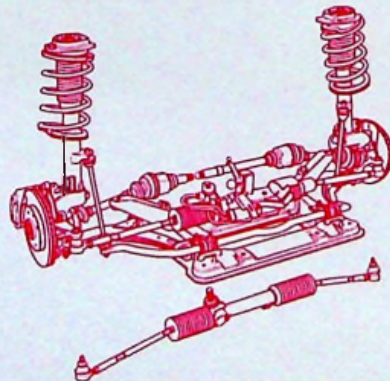
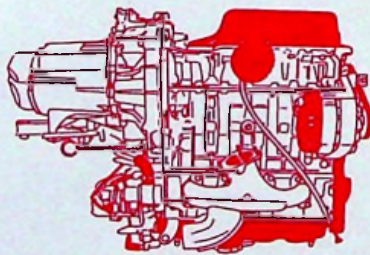
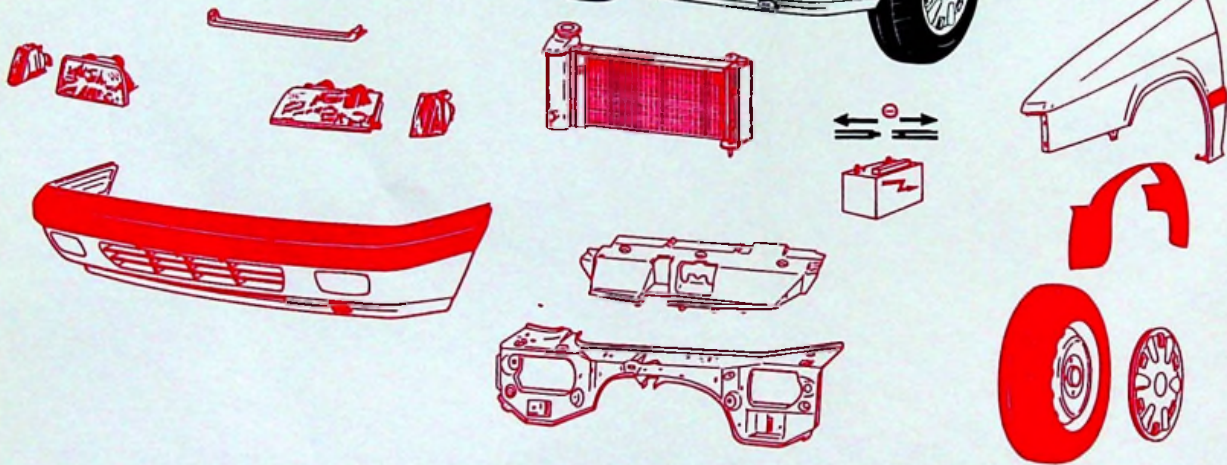
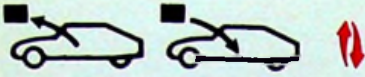
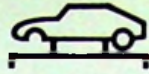



14

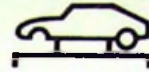

ZX
801-3/2

3

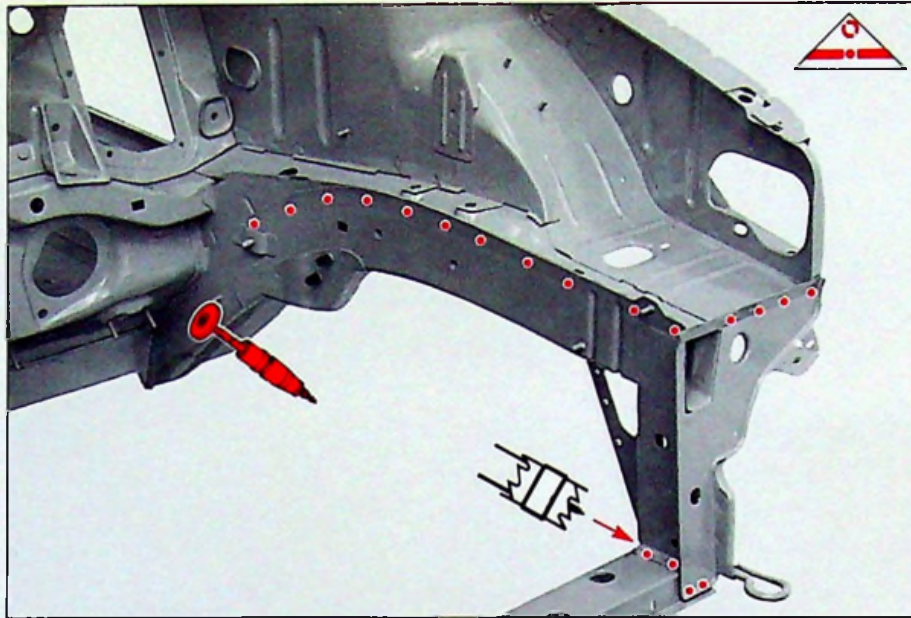

90-1104

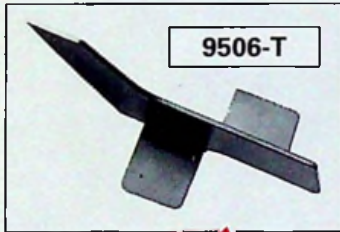

90-1406

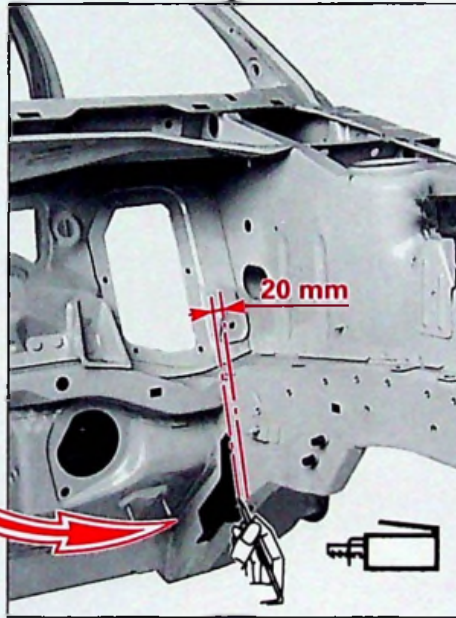

90-1413

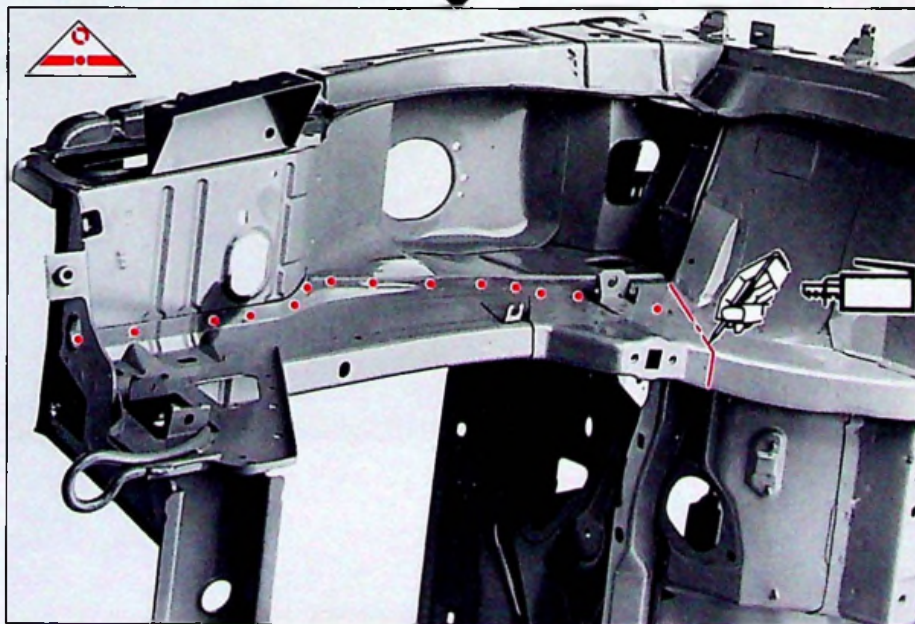

90-1073

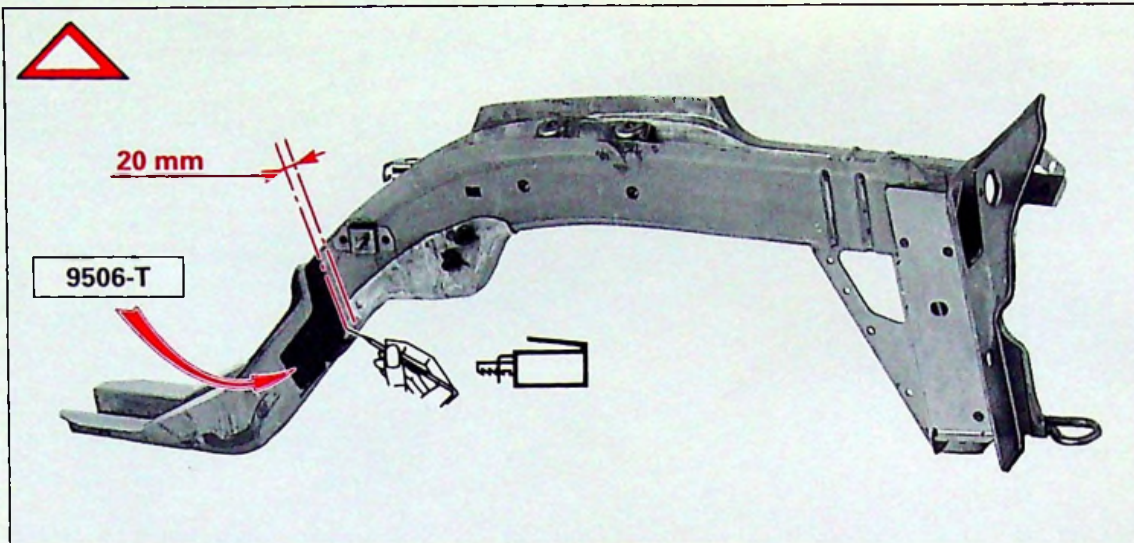
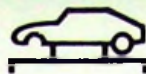

90-1409

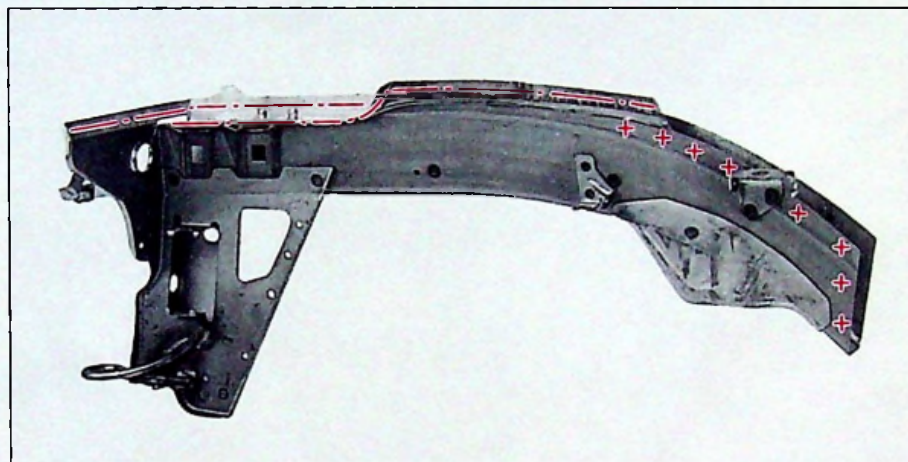

90-1411

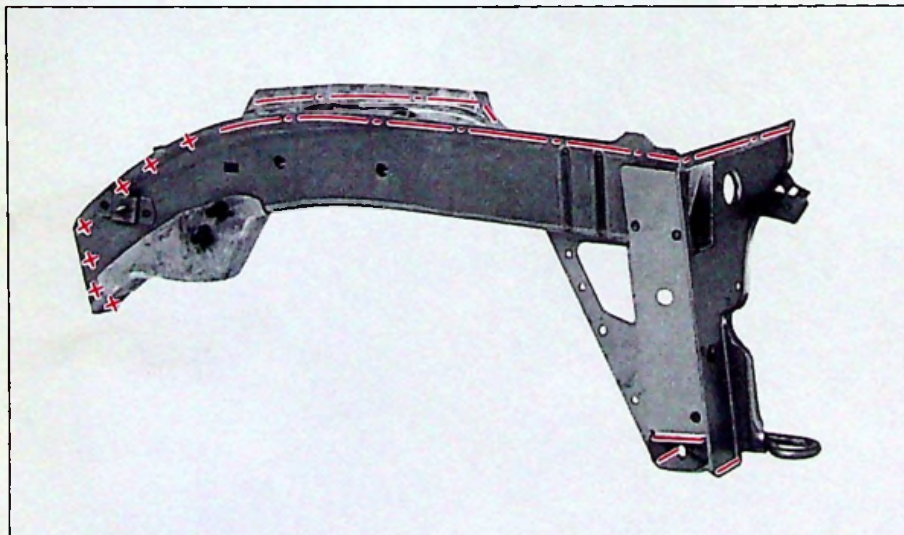

90-1410

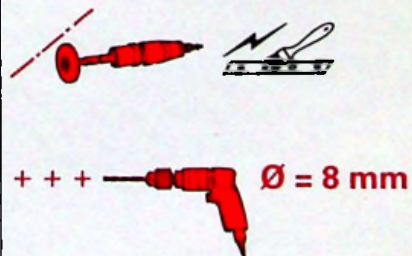

90-1405



14

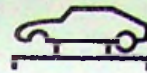

ZX
801-3/2

5

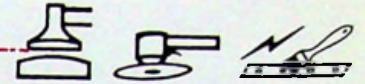
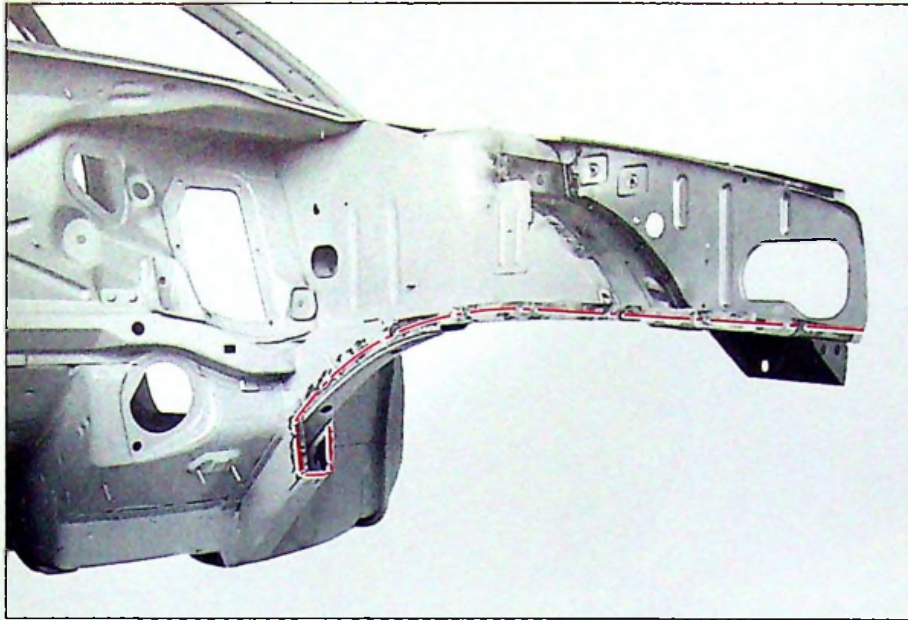

90-1414



90-1405

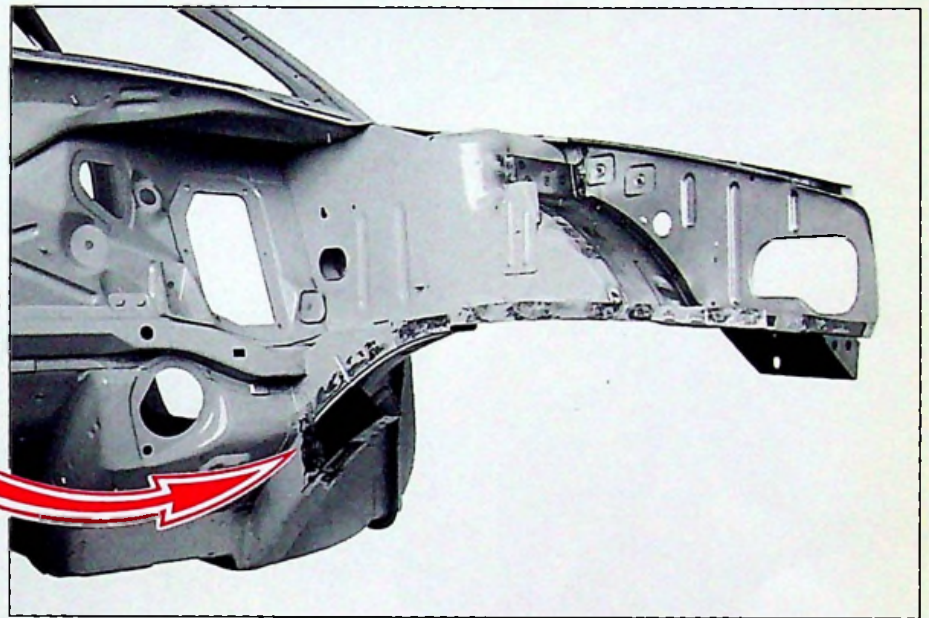
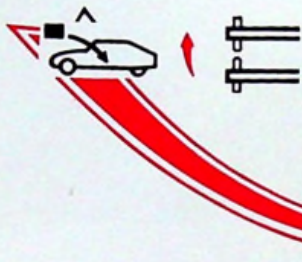

90-1415

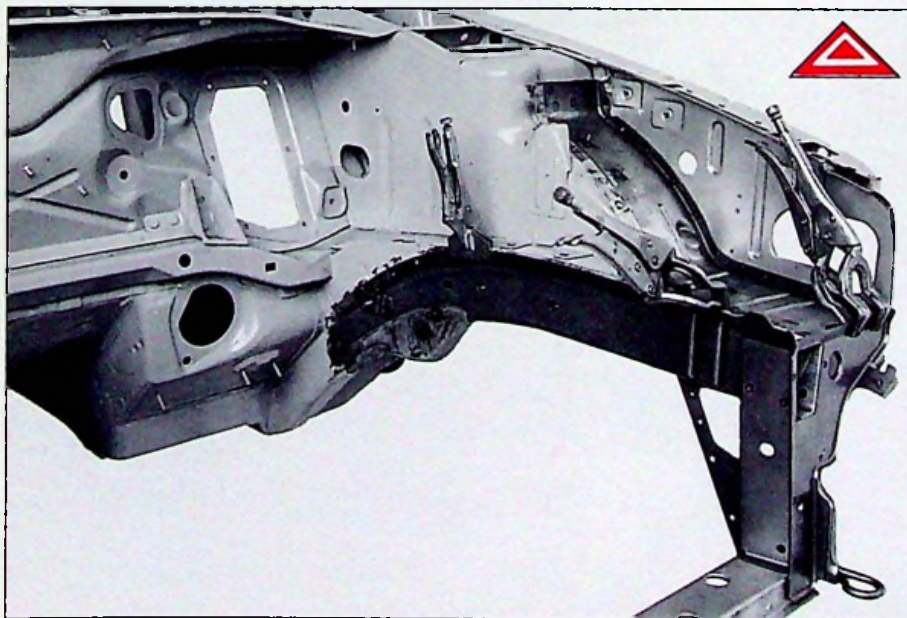

90-1416

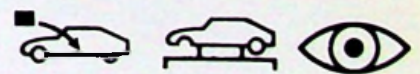

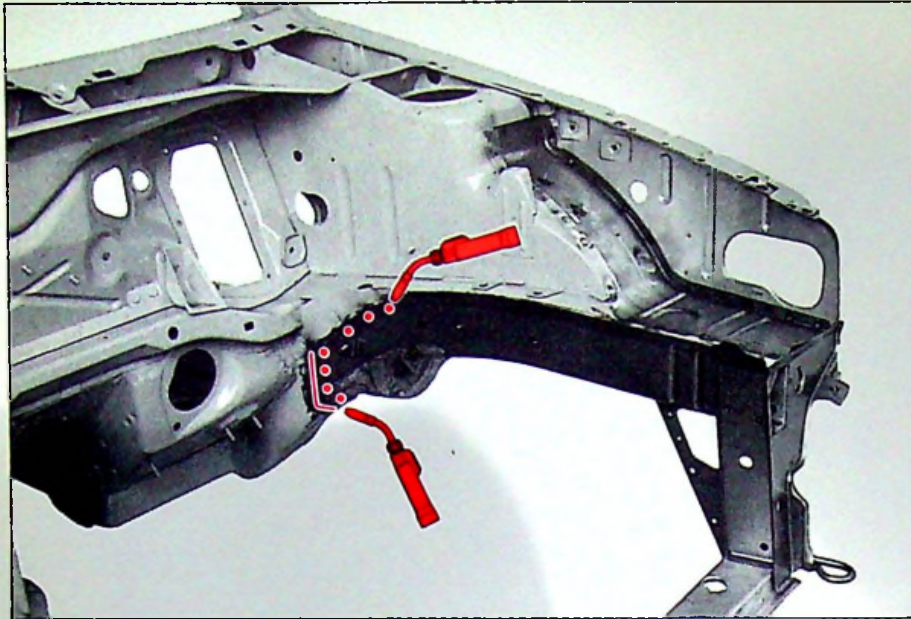
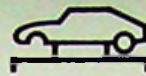

90-1417

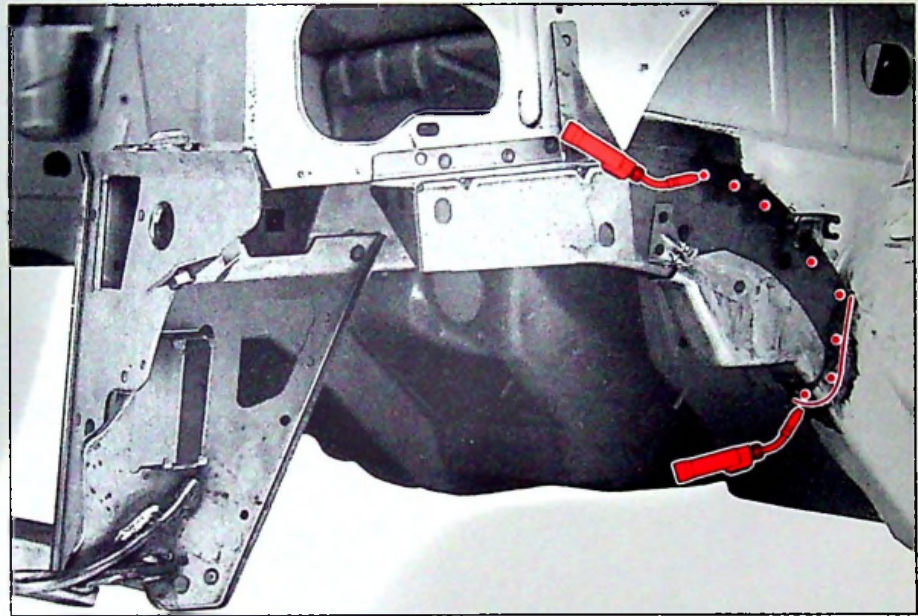

90-1418

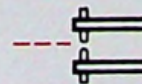
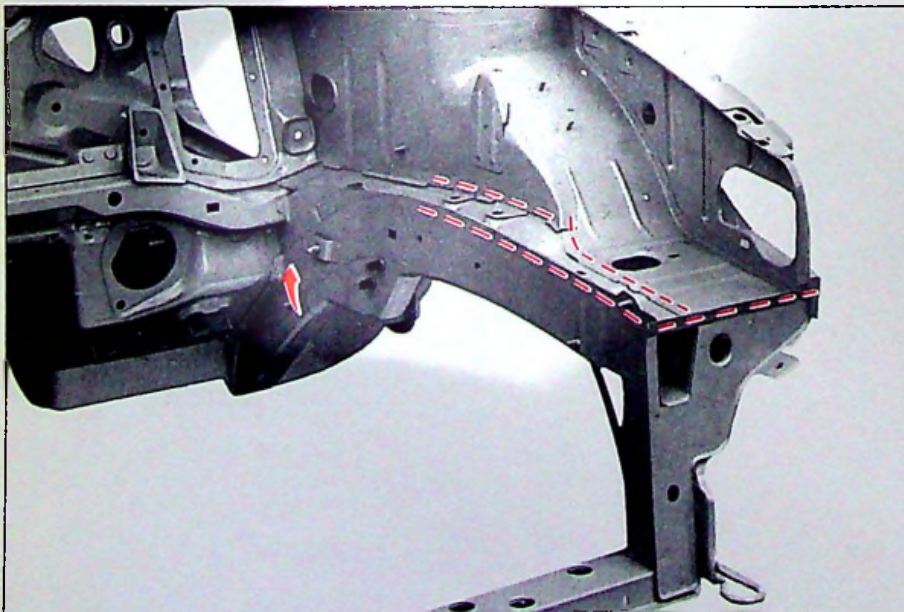

90-1074



14

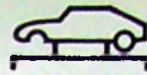

ZX
801-3/2

7

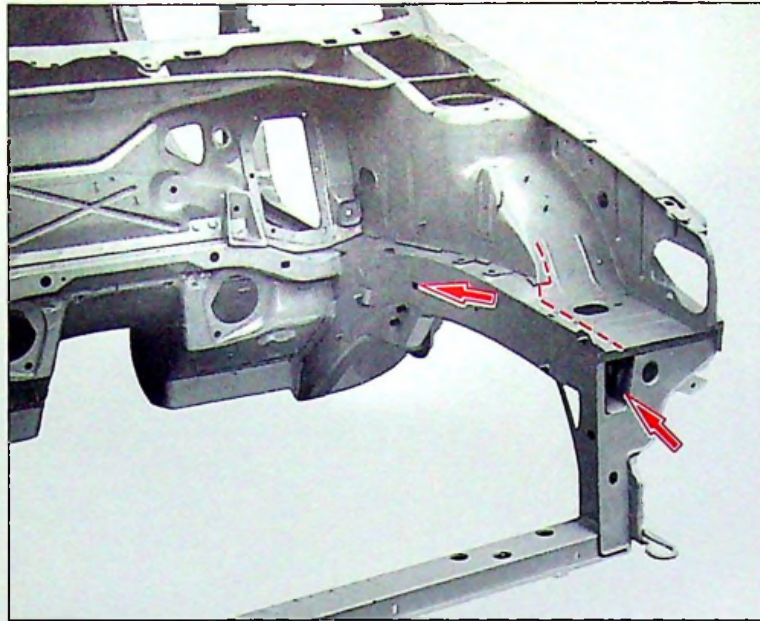

90-1074

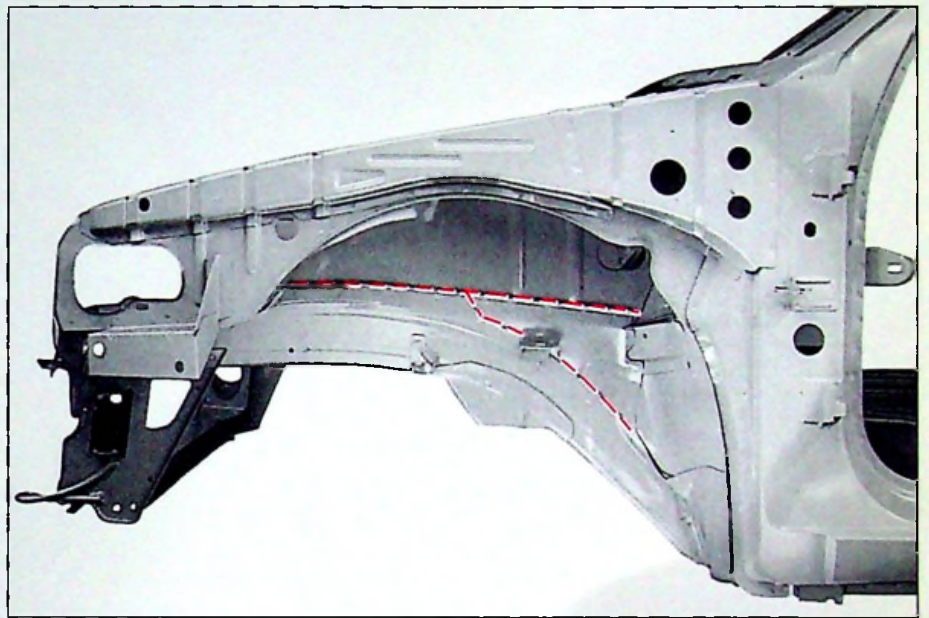
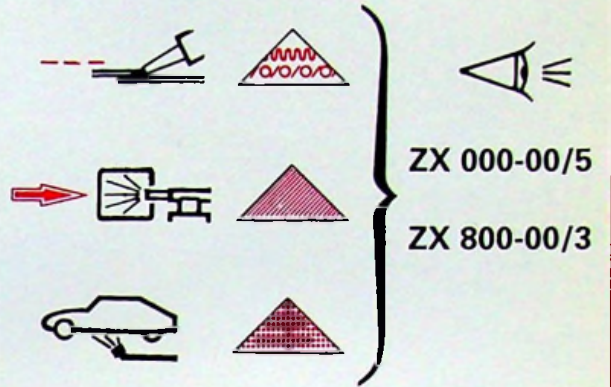

90-1085

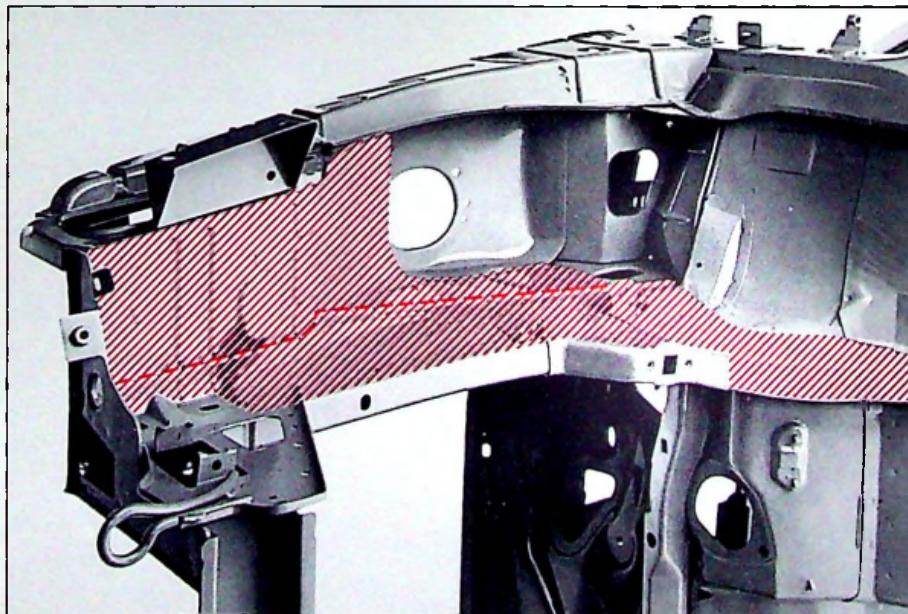

90-1073



14



ZX
801-3/3

1

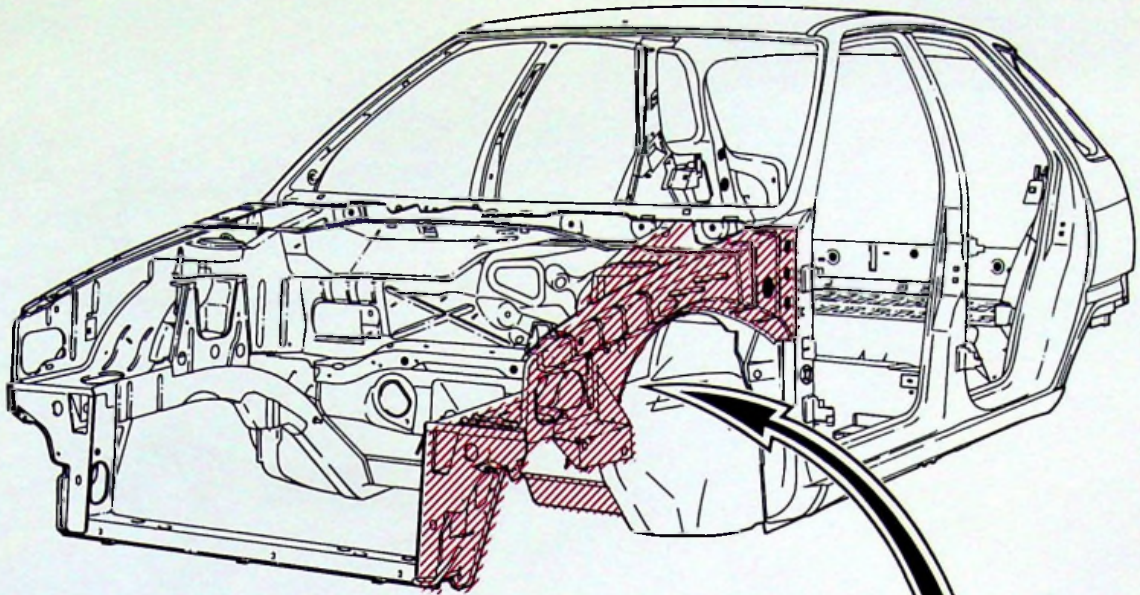

F.80-10

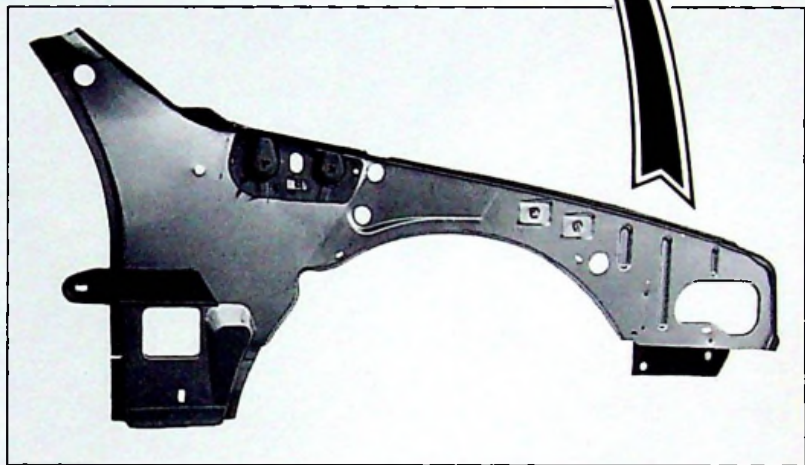

90-1132

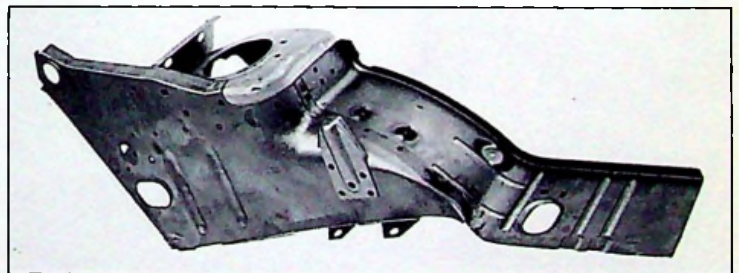

90-1124

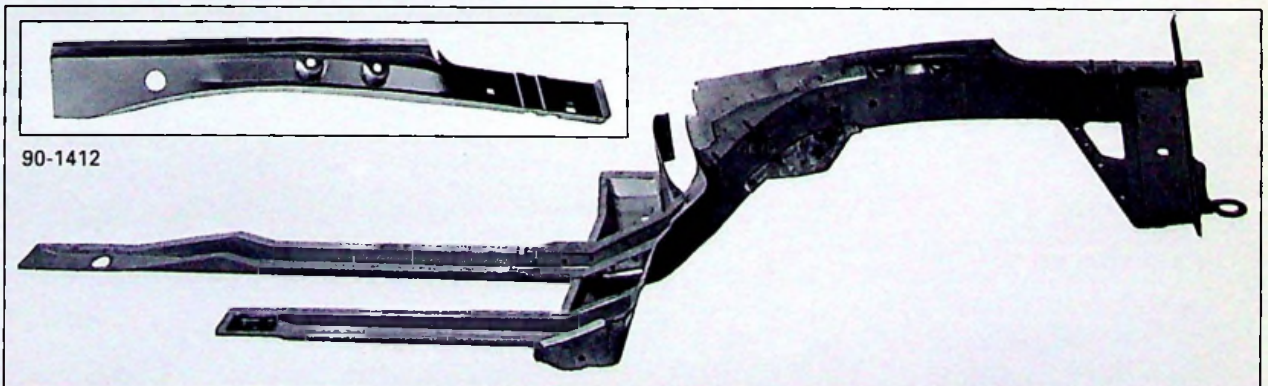

90-1412

90-1407

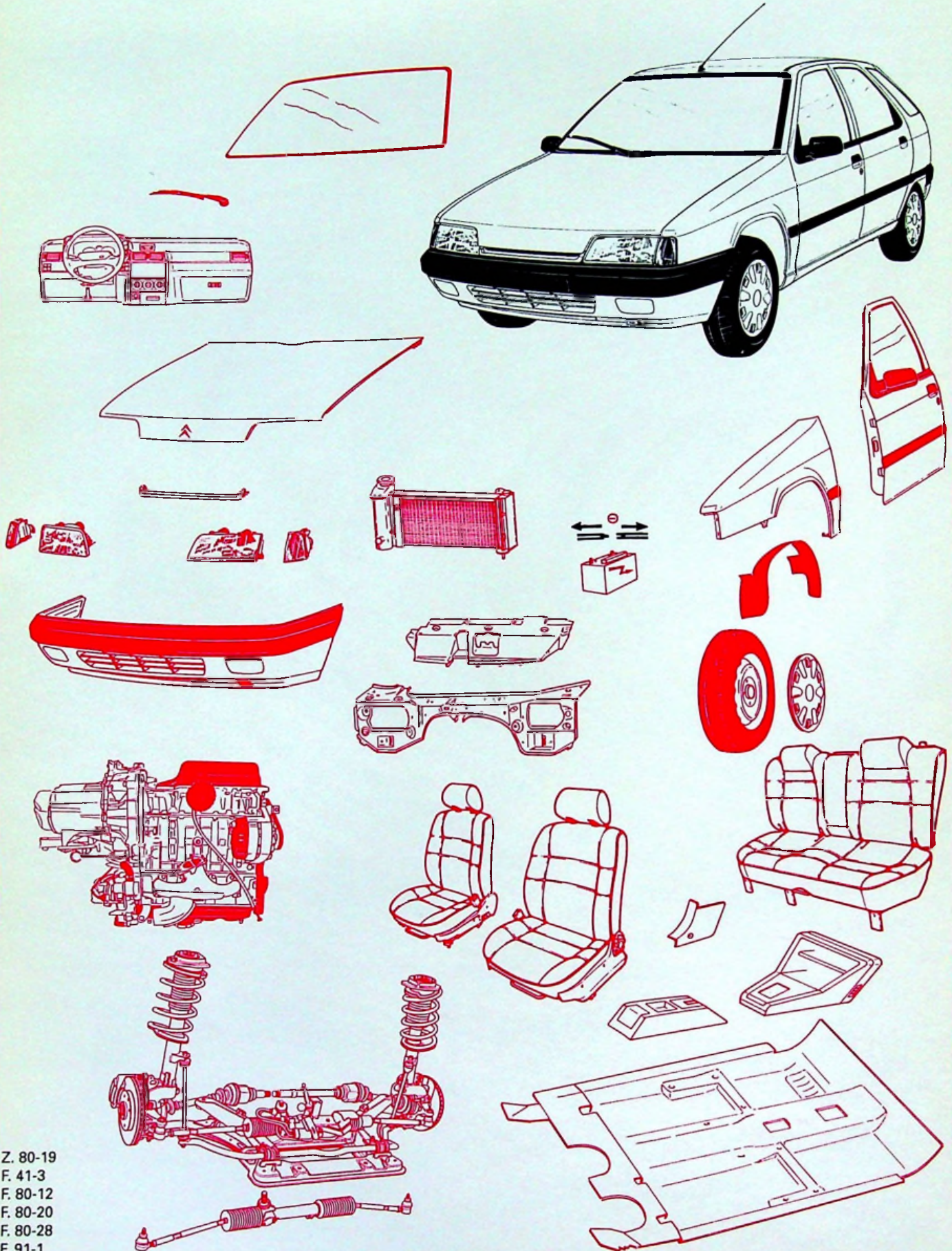
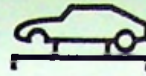
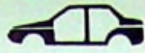

- Z. 80-19
- F. 41-3
- F. 80-12
- F. 80-20
- F. 80-28
- F. 91-1



14

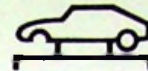

ZX
801-3/3

3

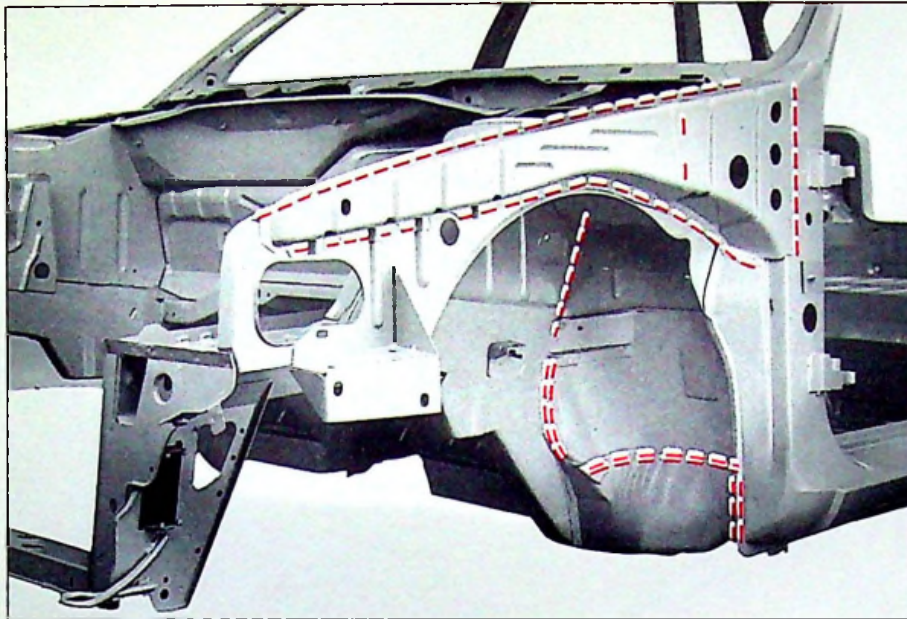

90-1090

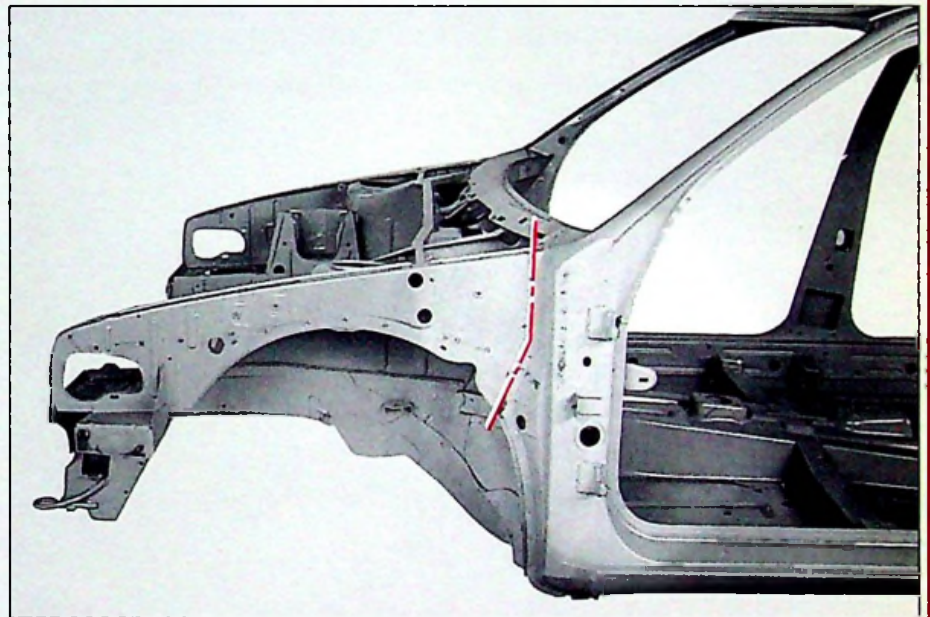
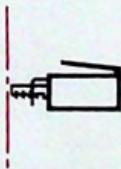
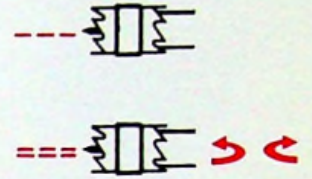

90-1518

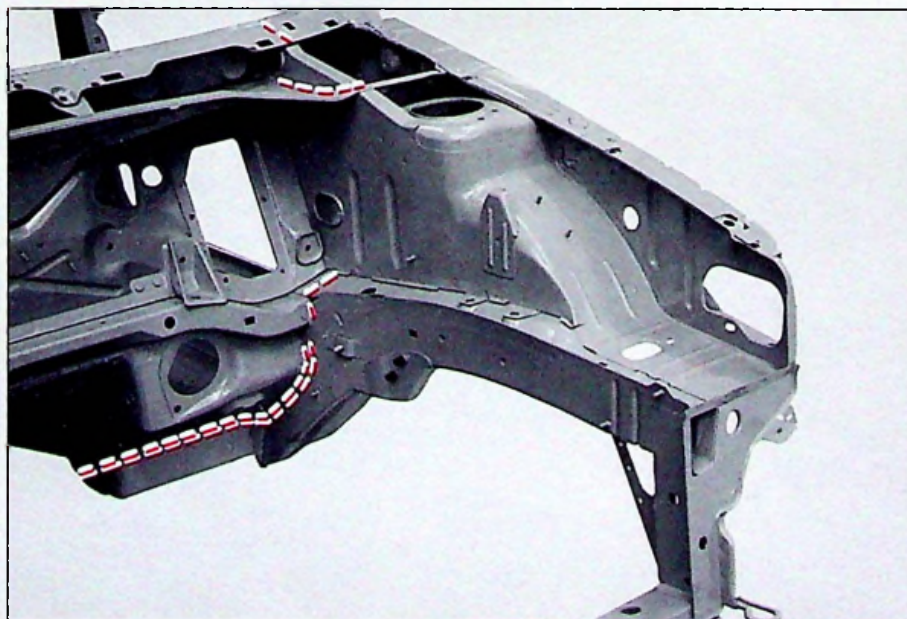

90-1104

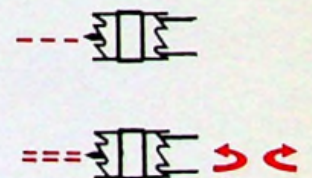

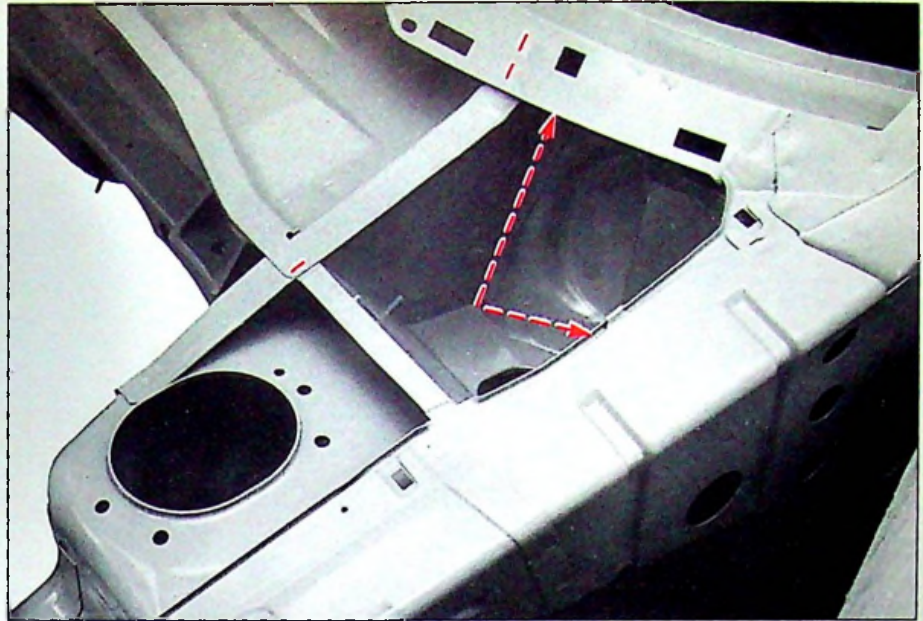

90-1101

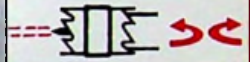
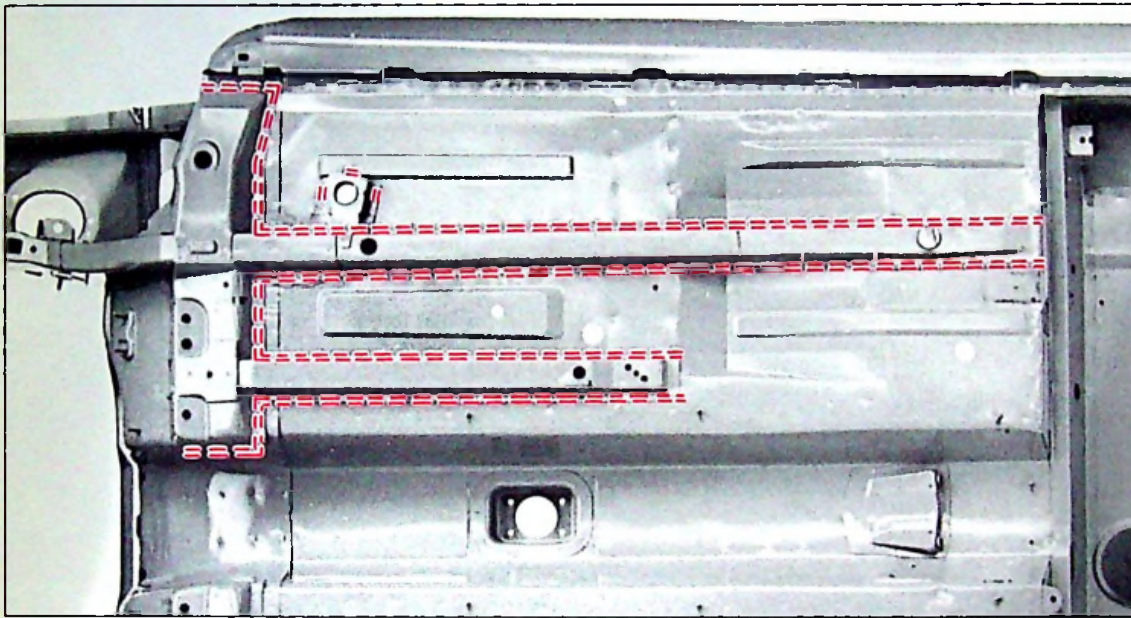

90-1070

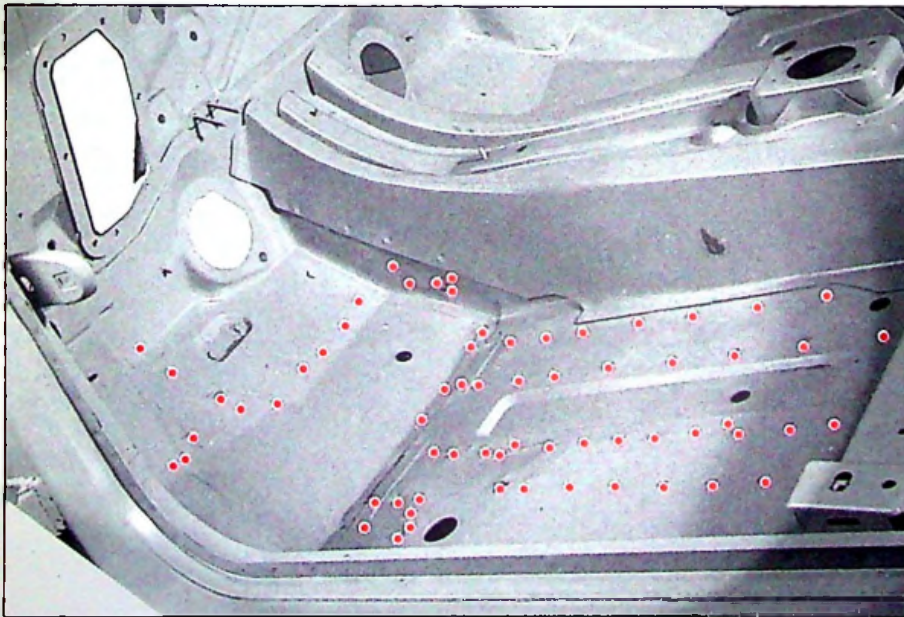

90-1437



14



ZX
801-3/3

5

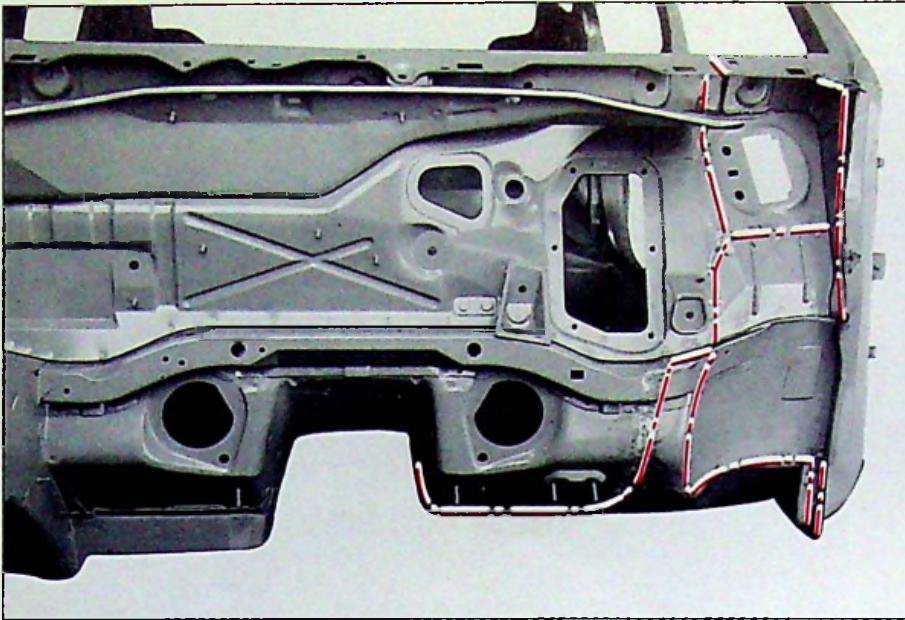

90-1434

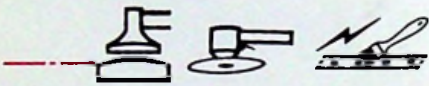
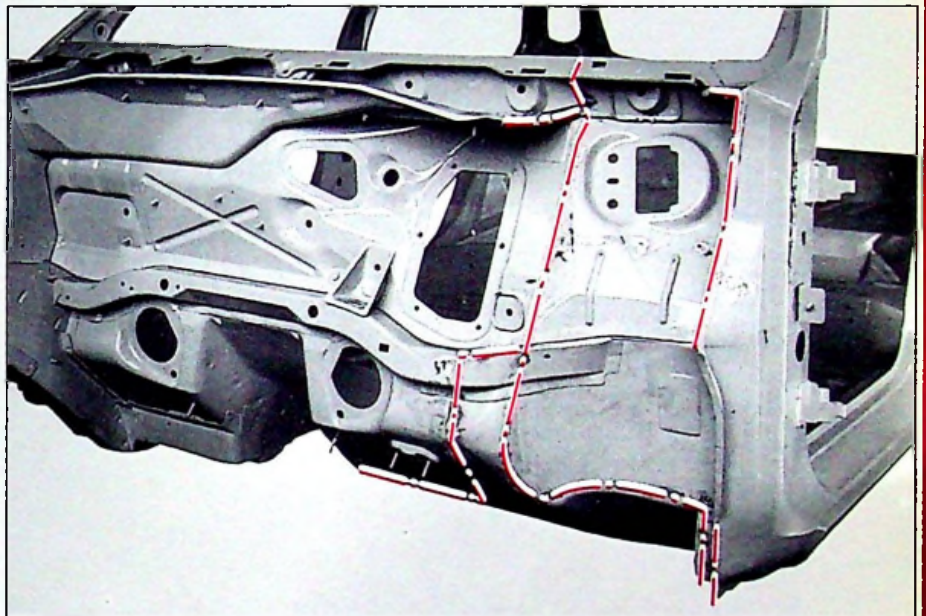

90-1435

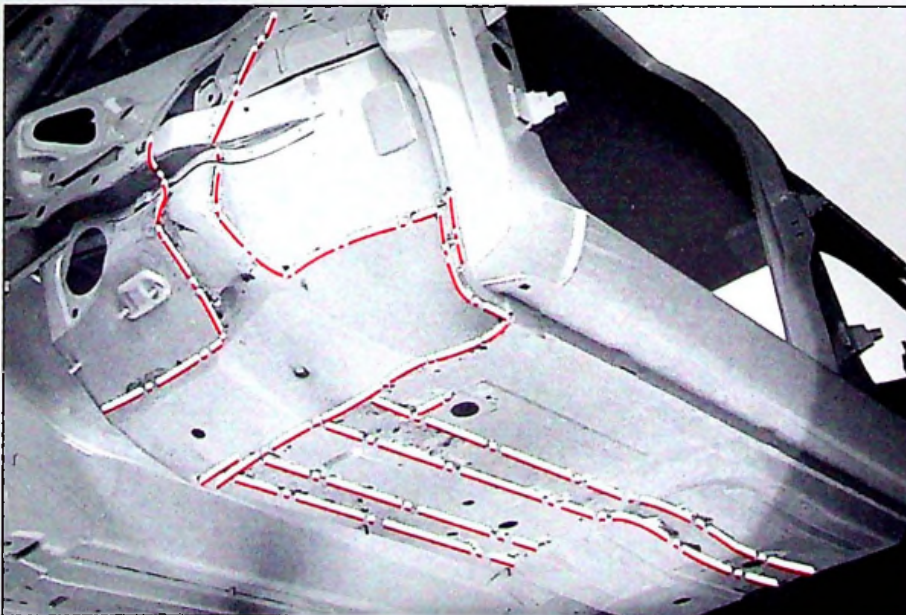

90-1436

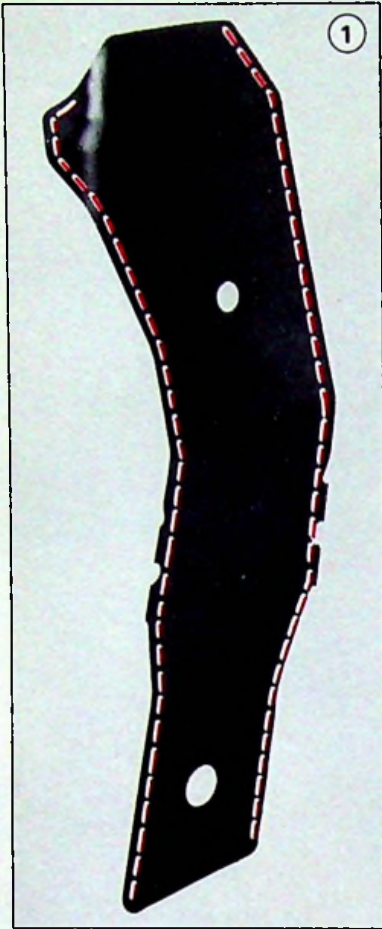

90-1441

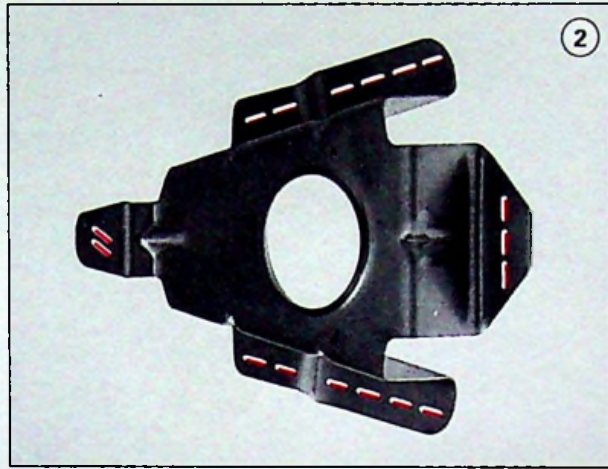

90-1442



+++ Ø = 8 mm

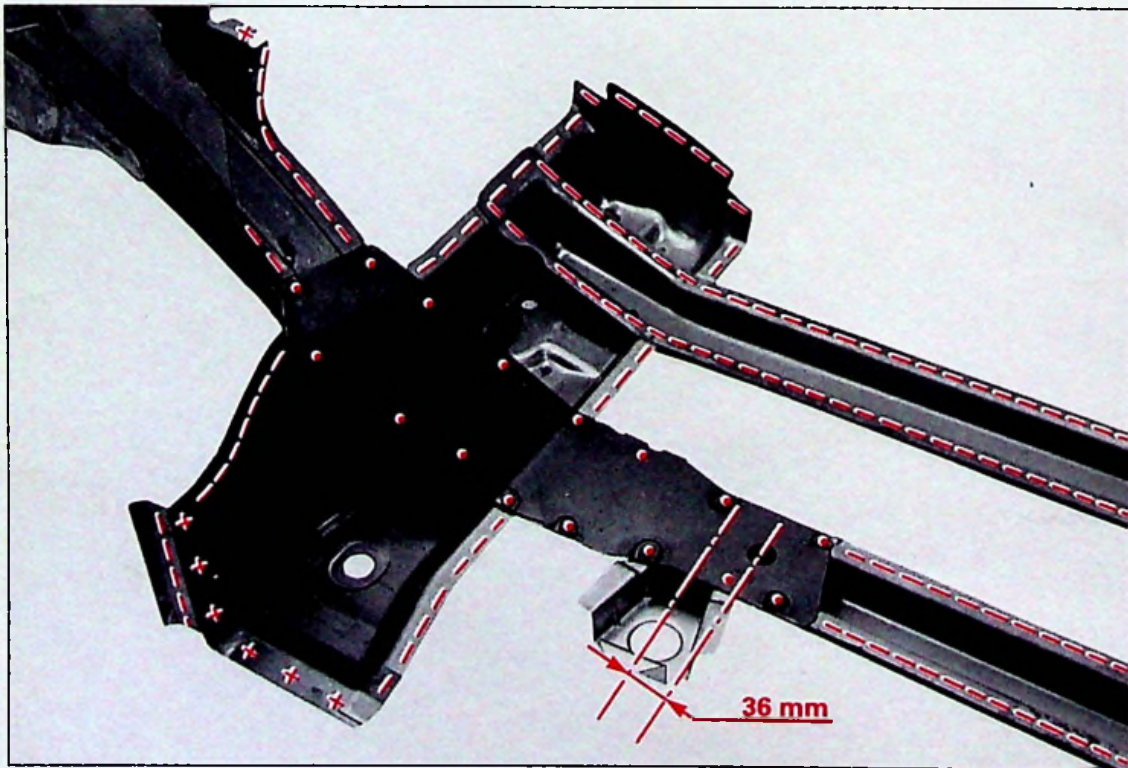
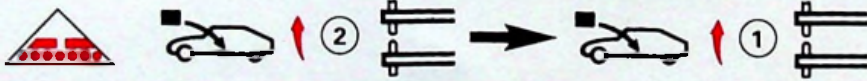

90-1439



14

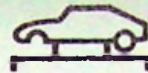

ZX
801-3/3

7

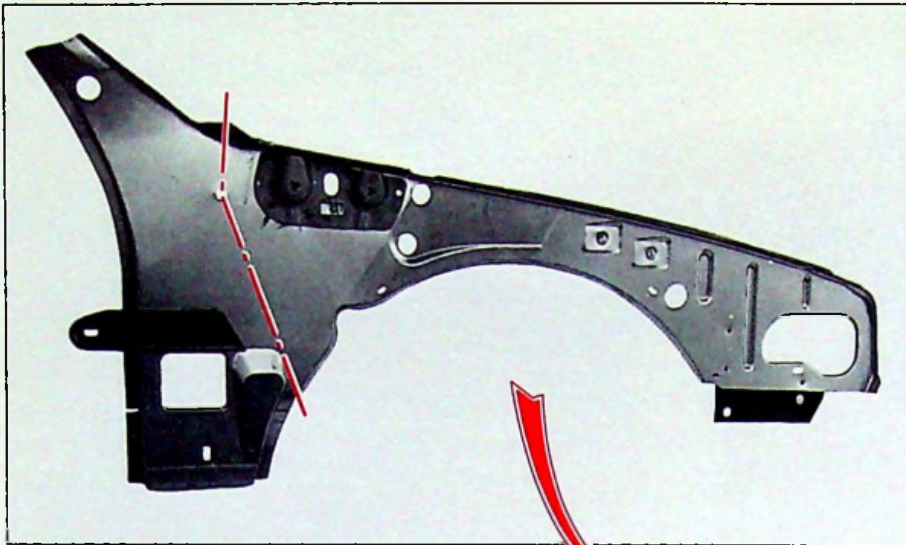

90-1132

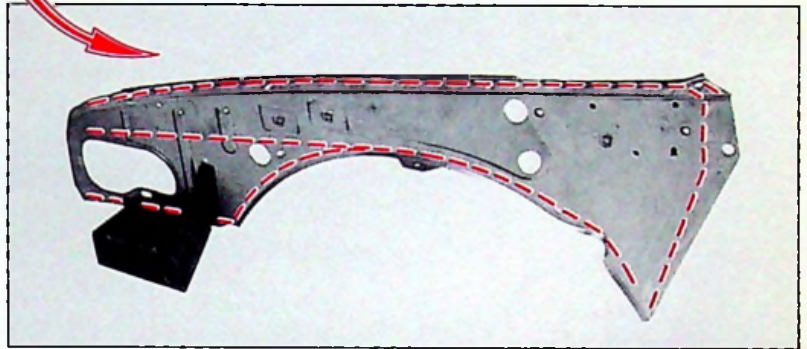
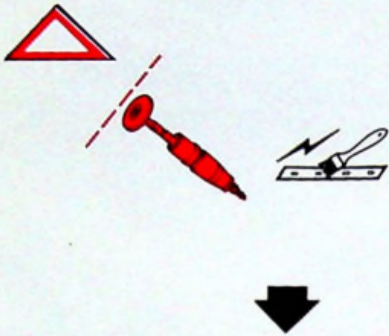

90-1438

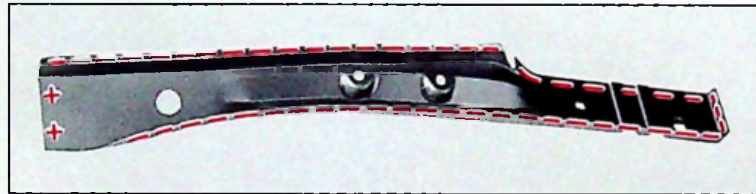

90-1412

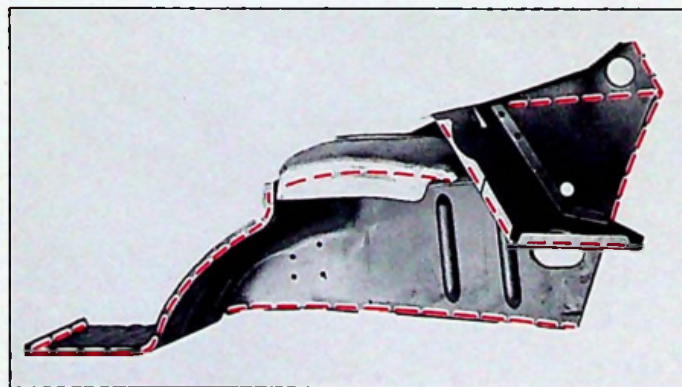
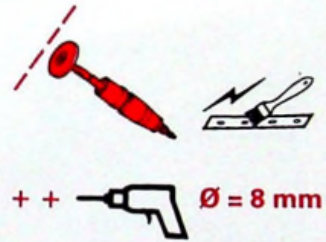

90-1123

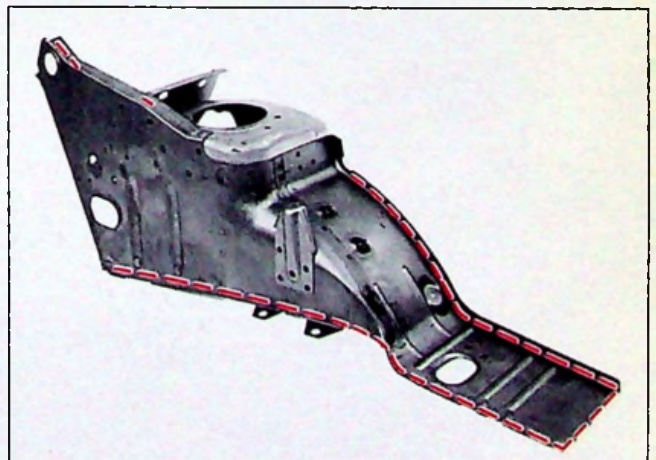

90-1124

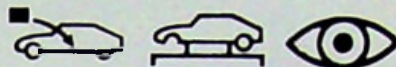
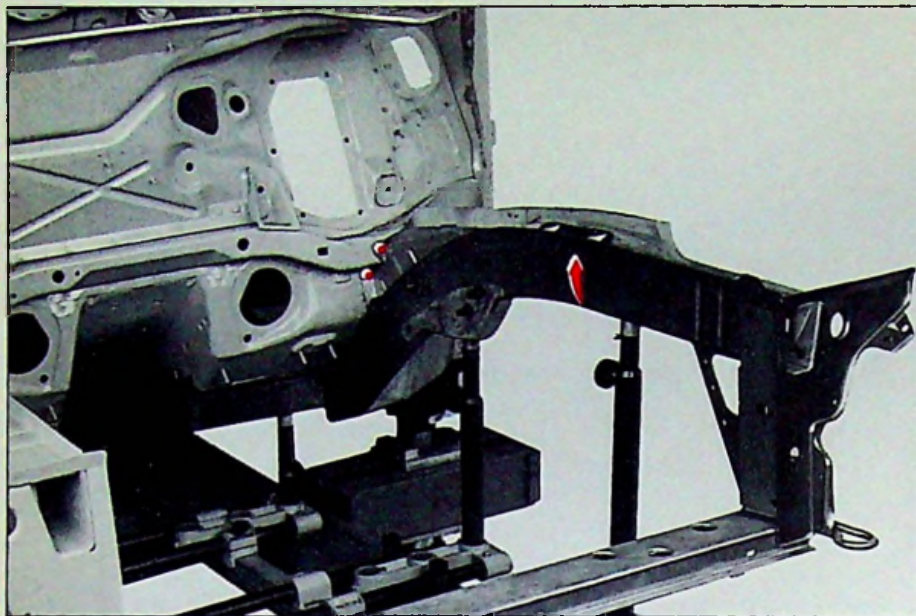
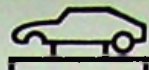

90-1448

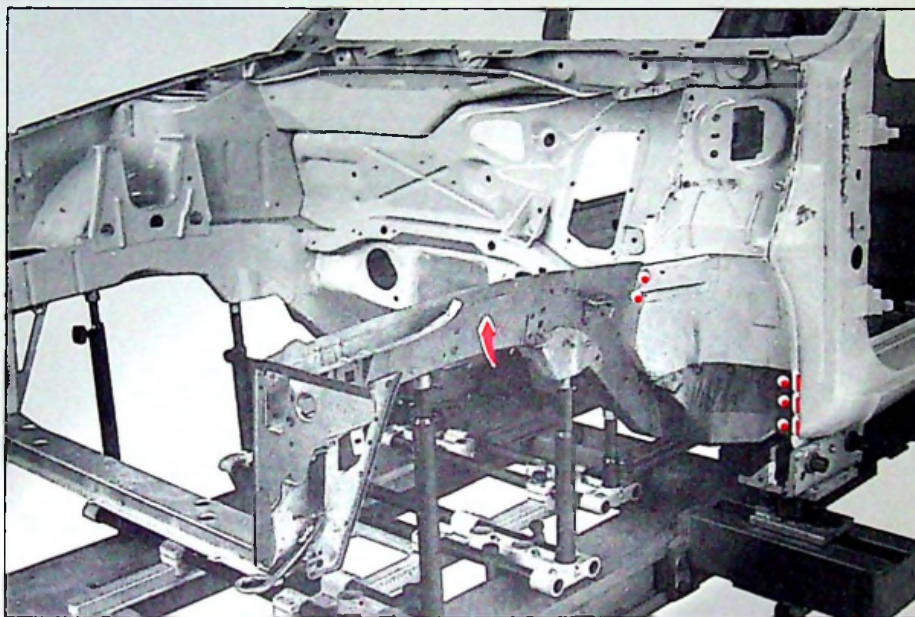
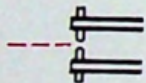

90-1449

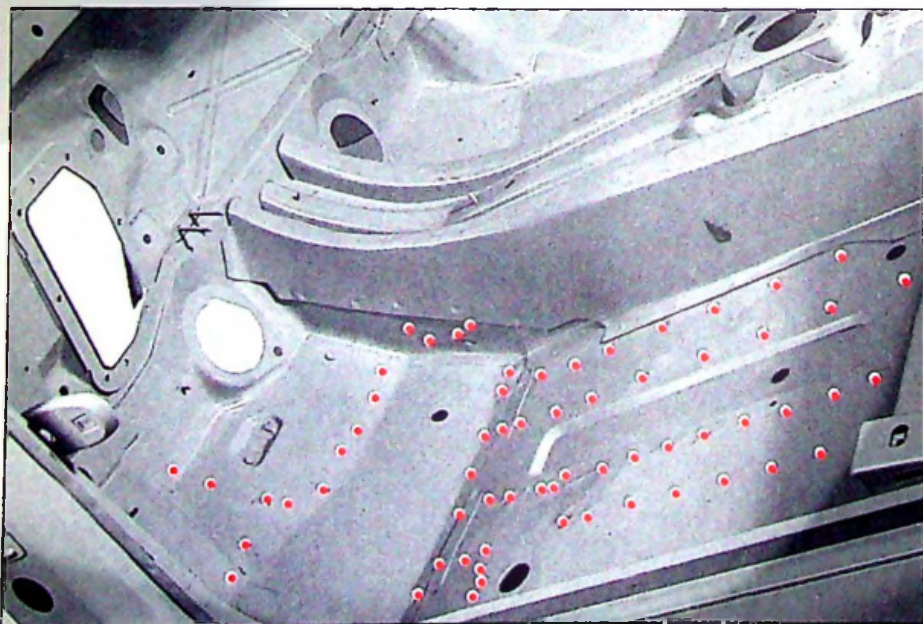

90-1437





14



ZX
801-3/3

9

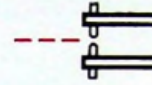
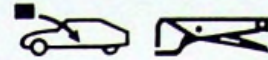
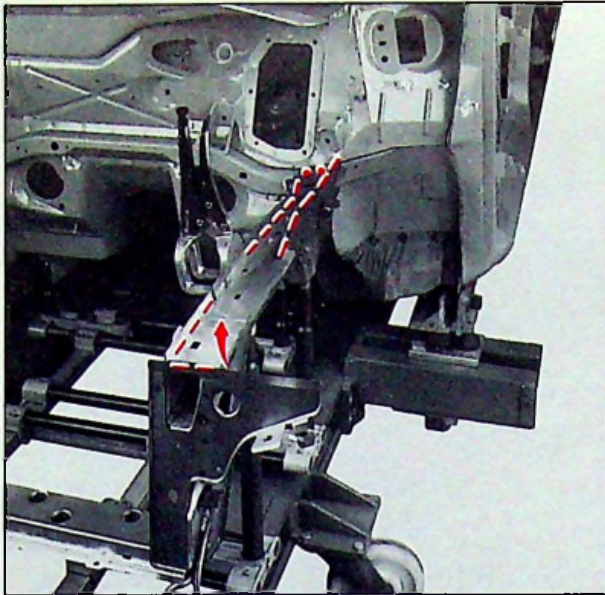

90-1450

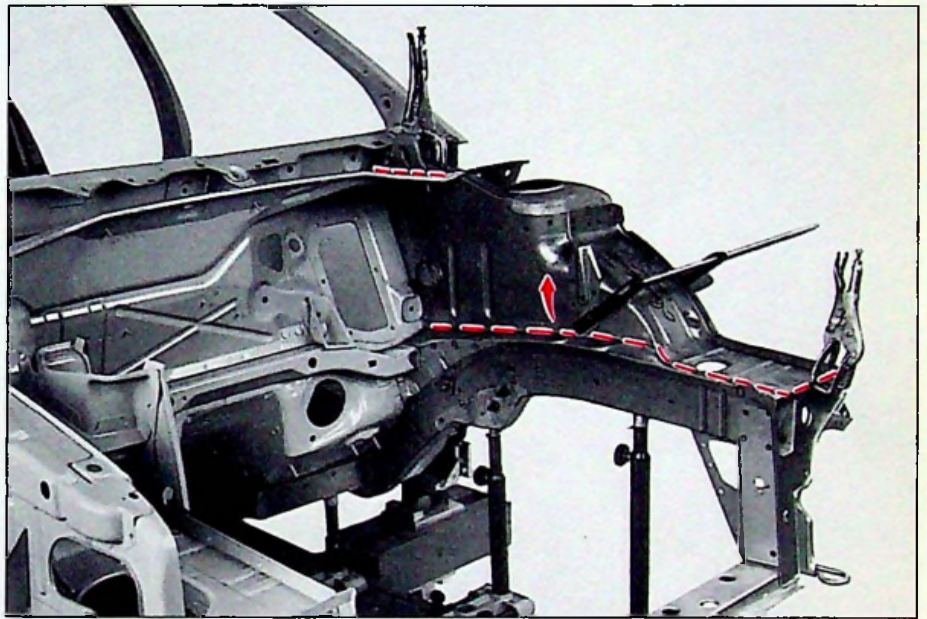
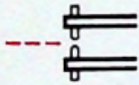
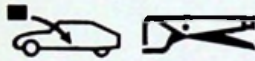

90-1451



90-1453

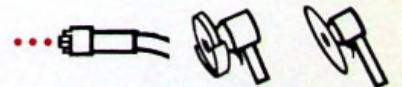
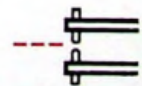

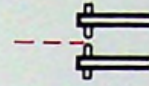
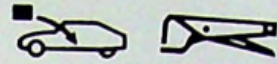
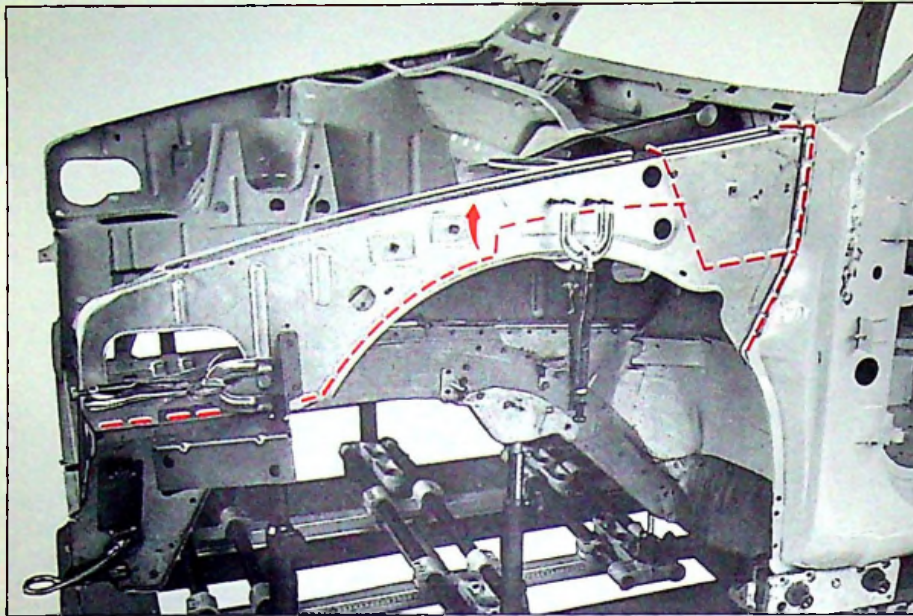
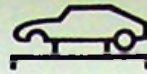

90-1454

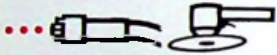
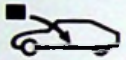
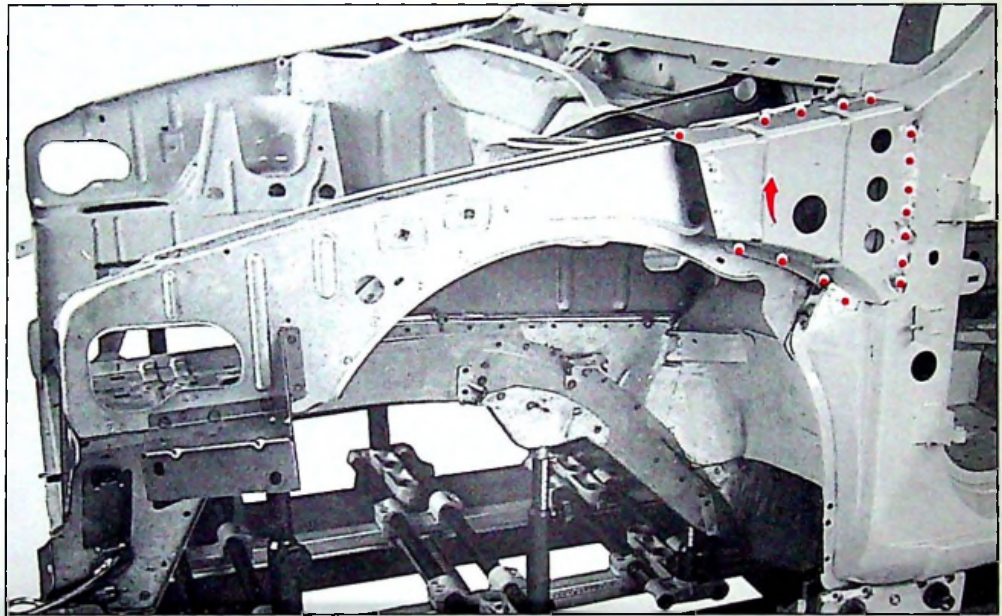

90-1455

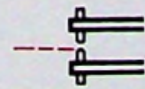
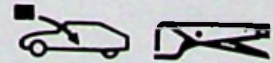
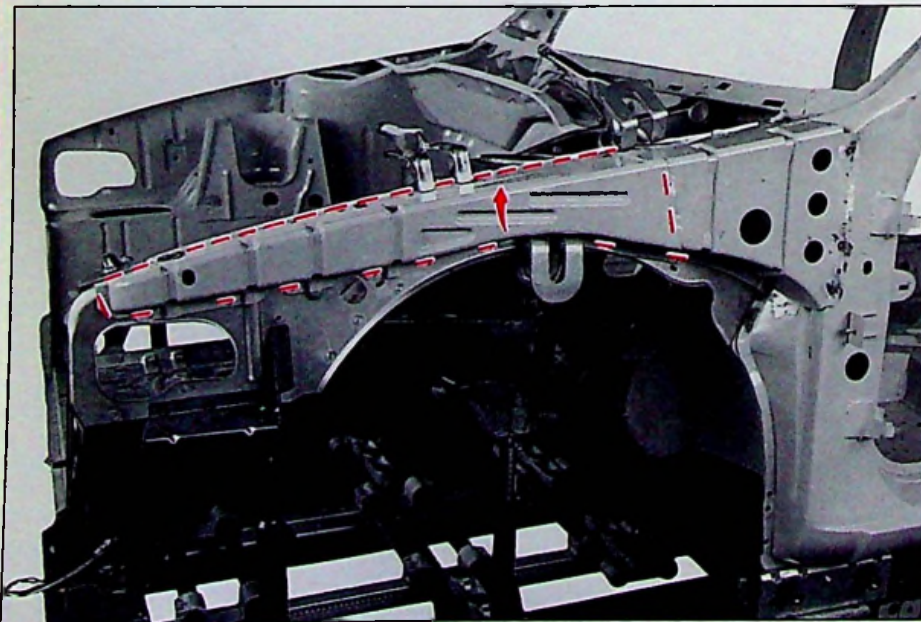

90-1456



14

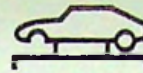

ZX
801-3/3

11

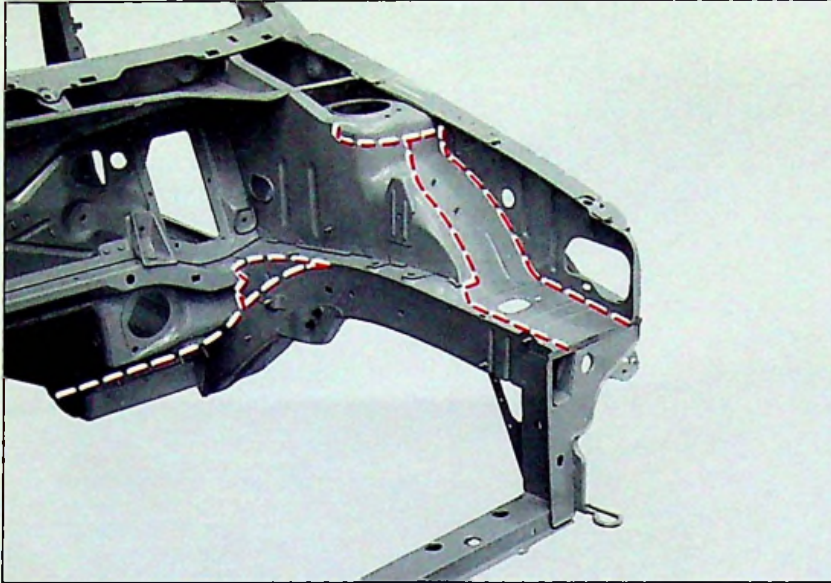

90-1074

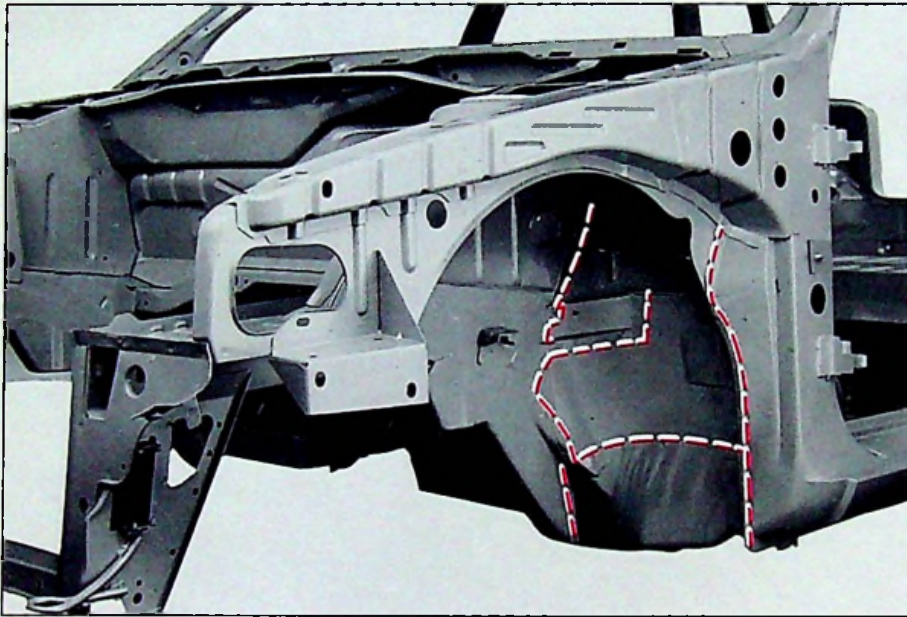

90-1090

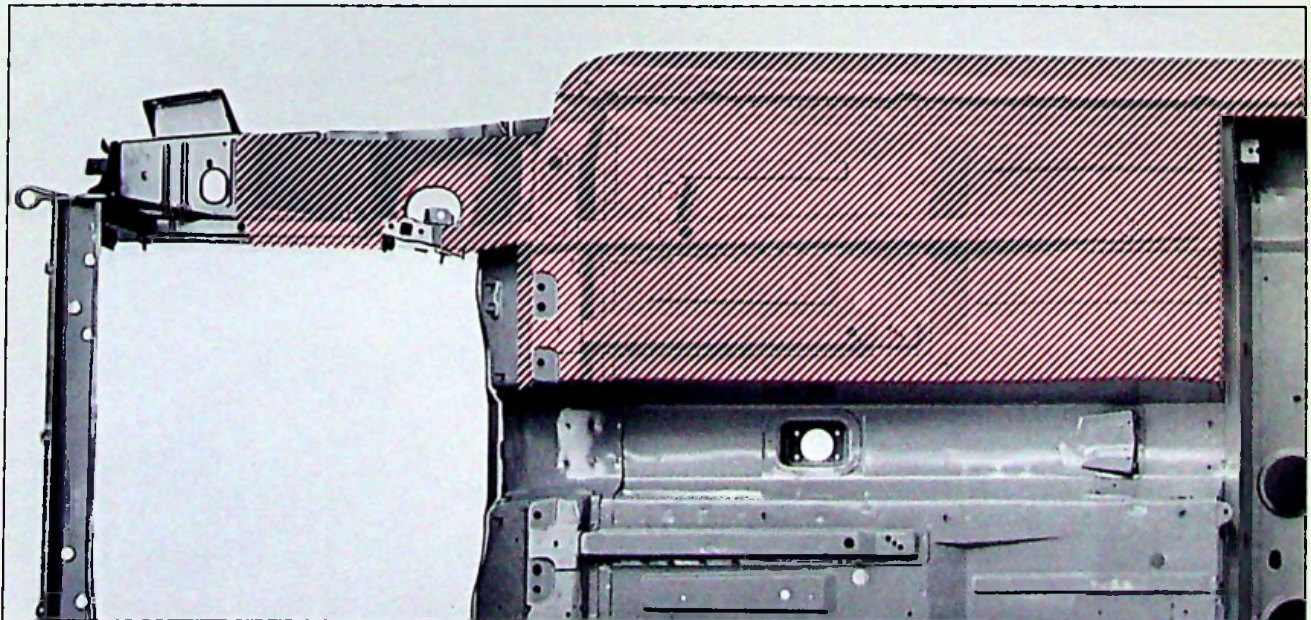

90-1070

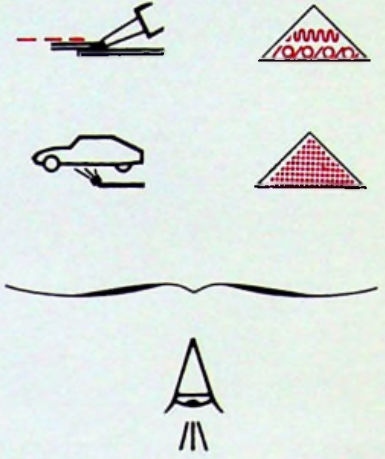

ZX 000-00/5

ZX 800-00/3

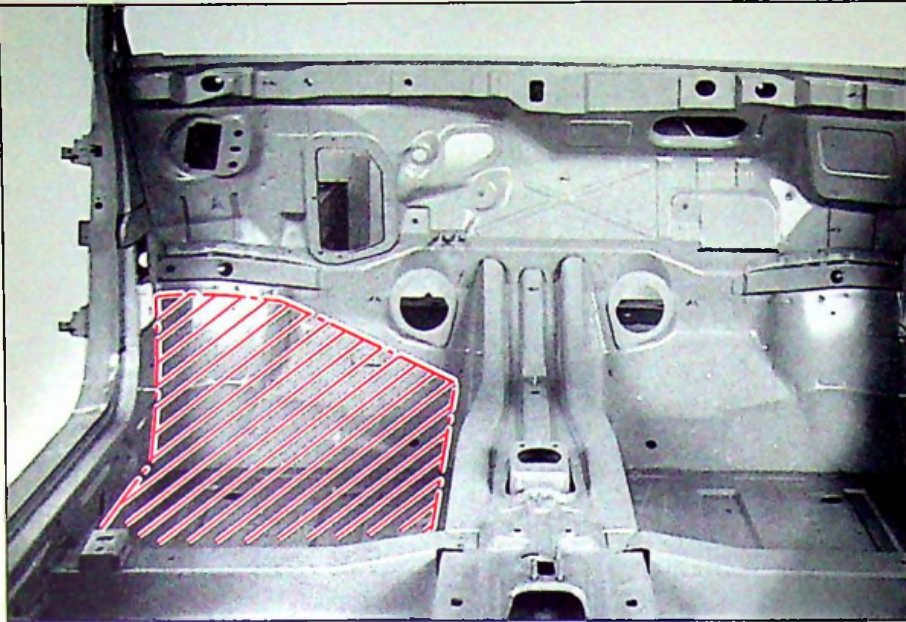
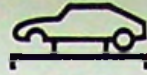

90-1081

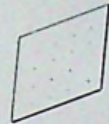

D5

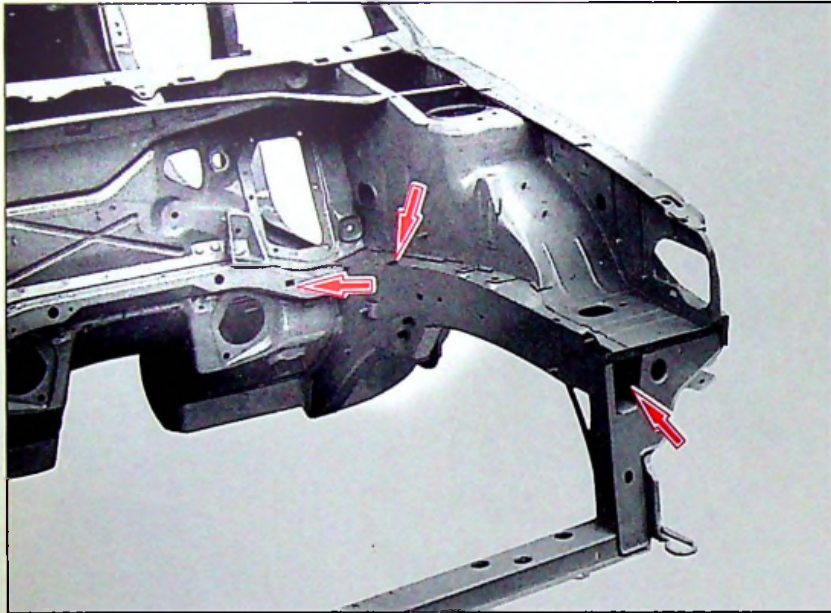

90-1074

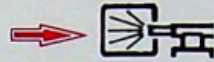

ZX 000-00/5

ZX 800-00/3

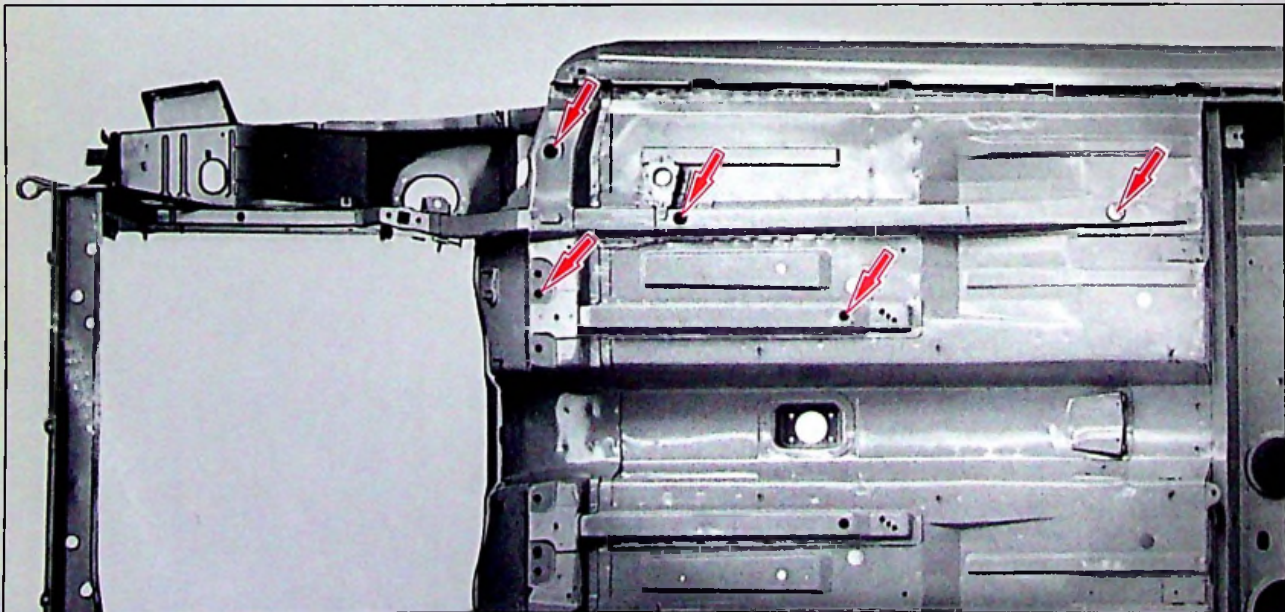

90-1070



14



ZX
801-3/4

1

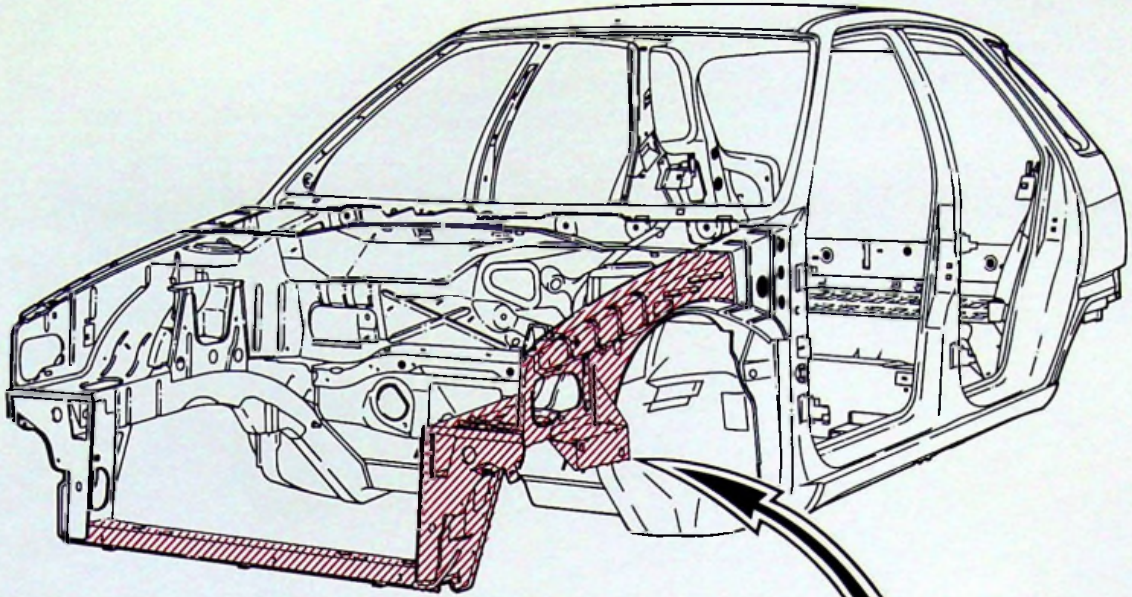

F.80-10

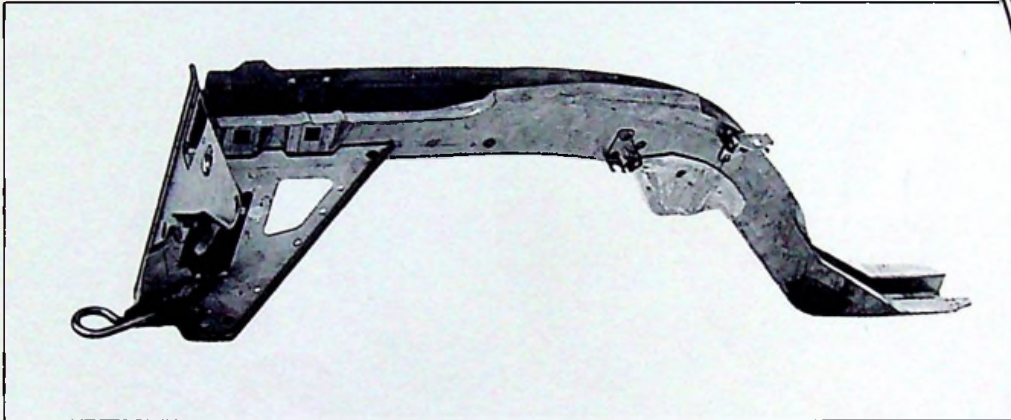

90-1122



90-1135

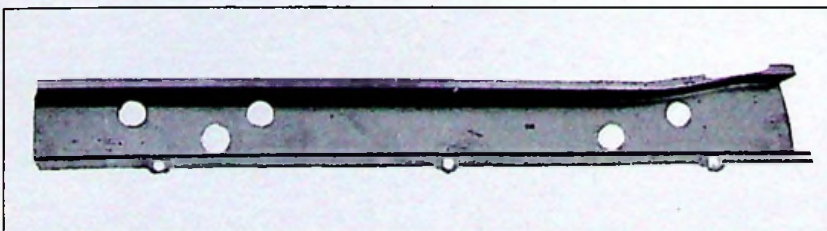

90-1136

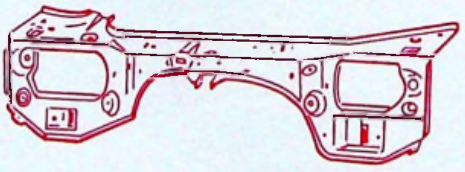
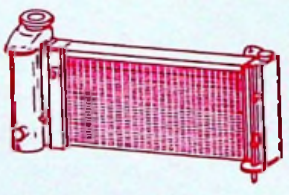
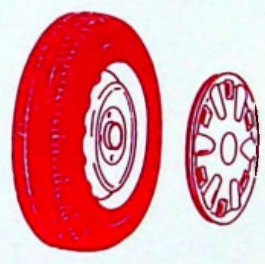
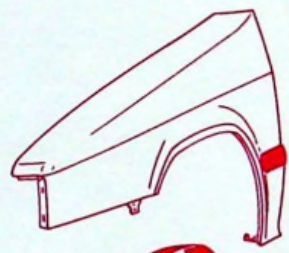
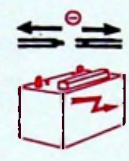
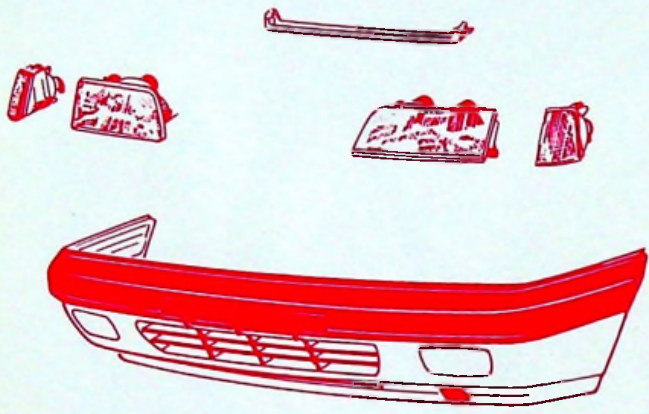
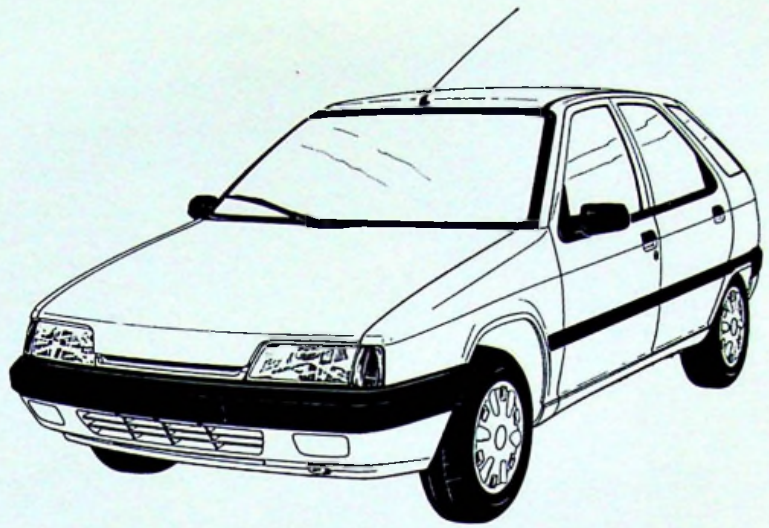
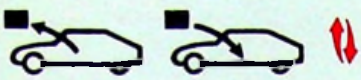
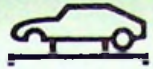



14



ZX
801-3/4

3

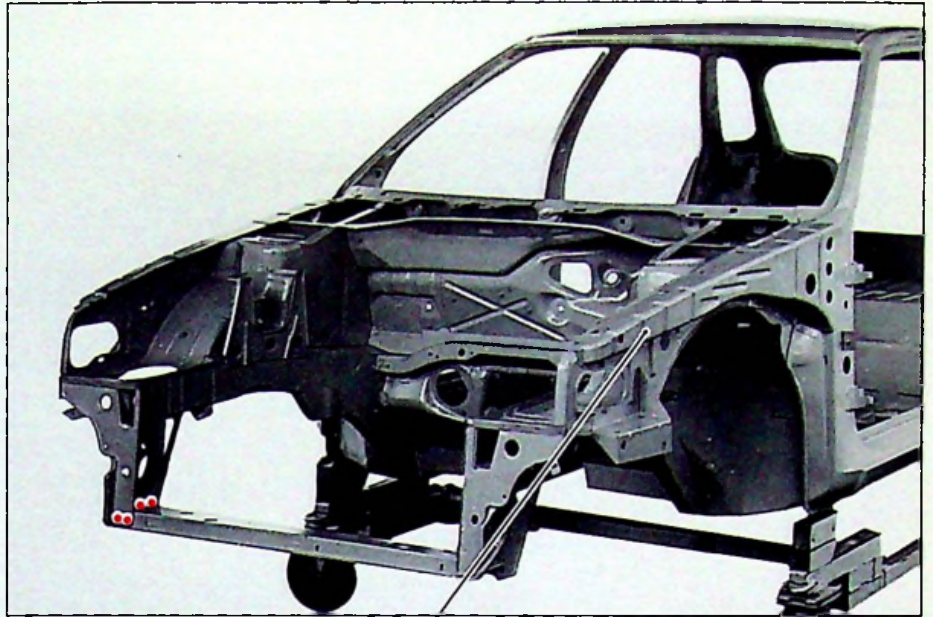

90-1075

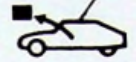

ZX 801-3/1

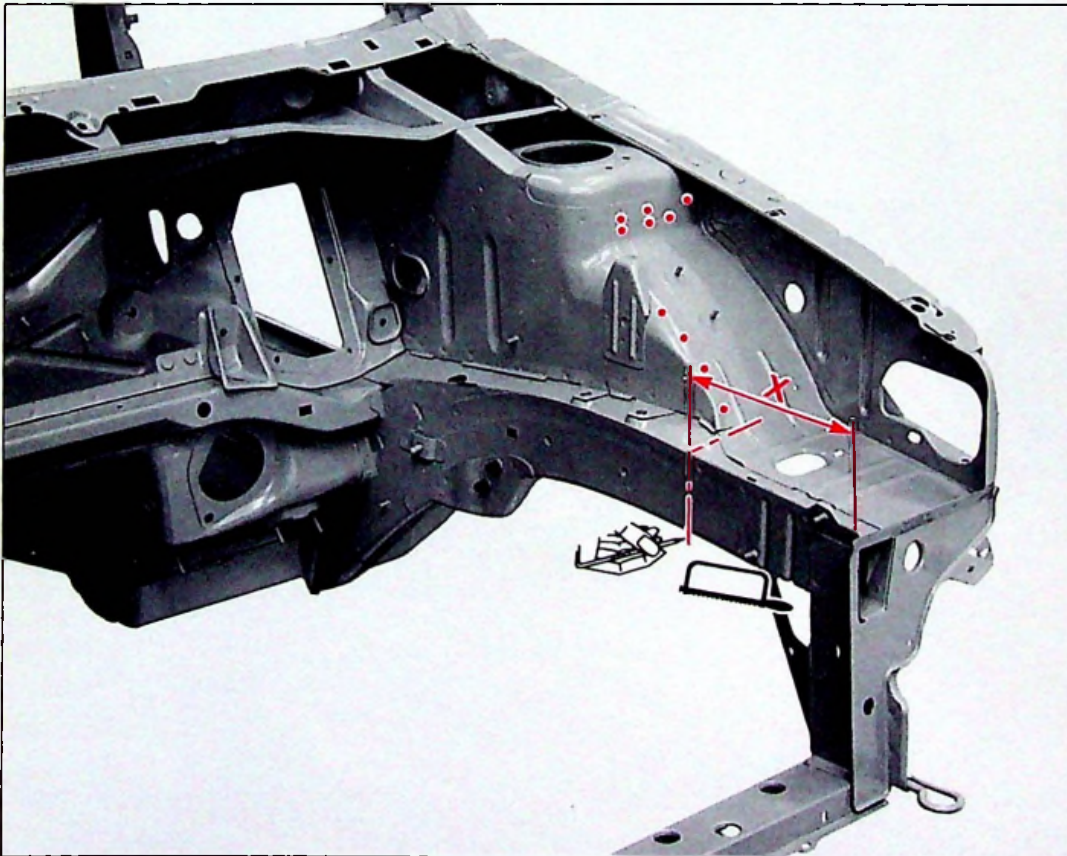

90-1104

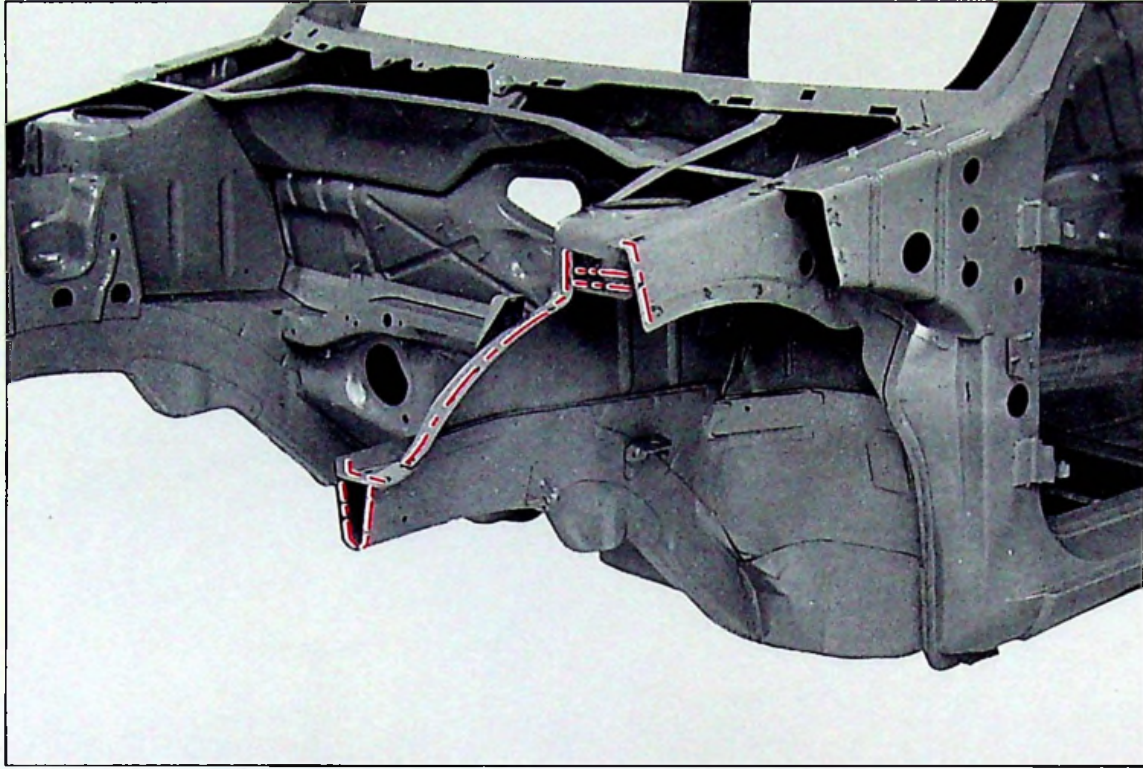
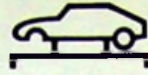

90-1185

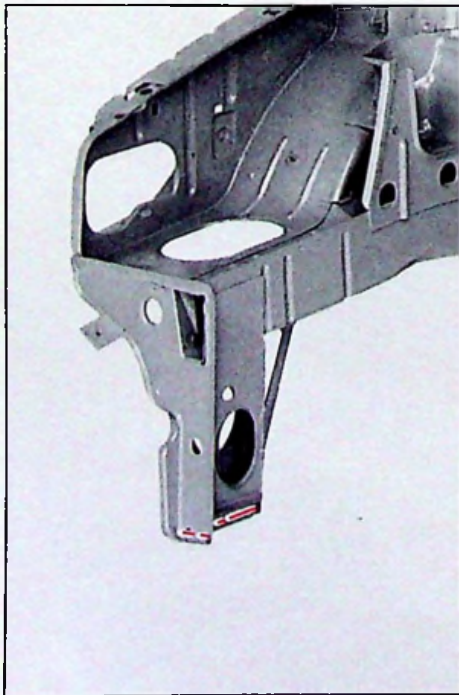

90-1215





14



ZX
801-3/4

5

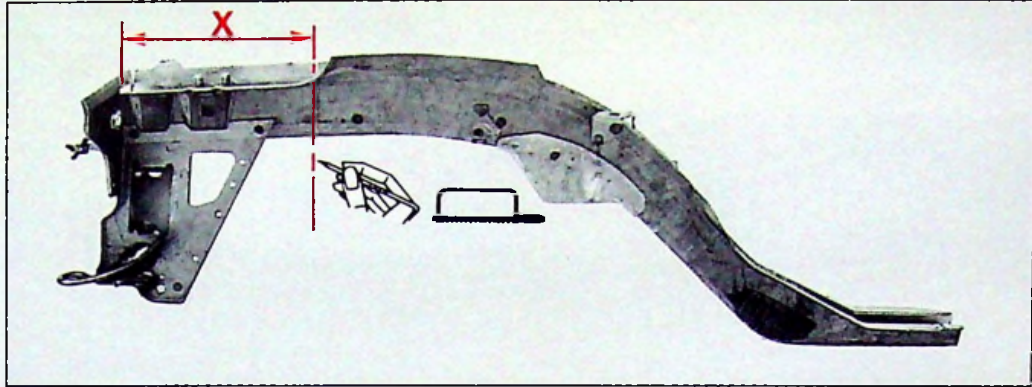

90-1121

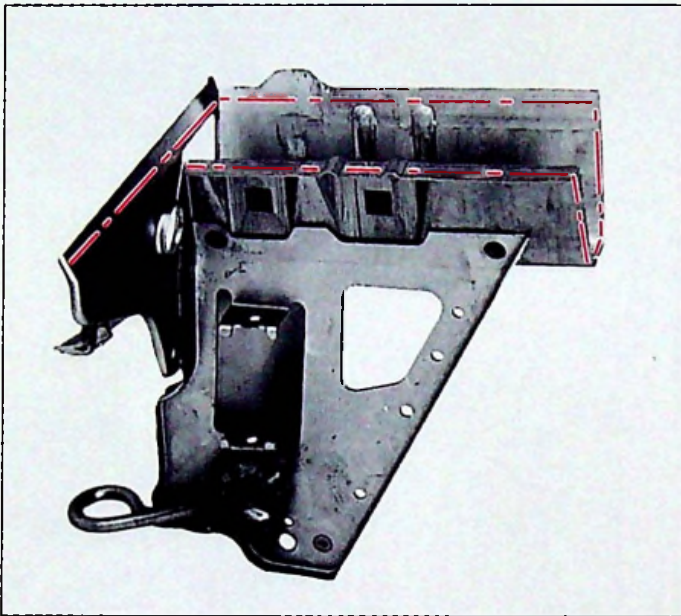

90-1206

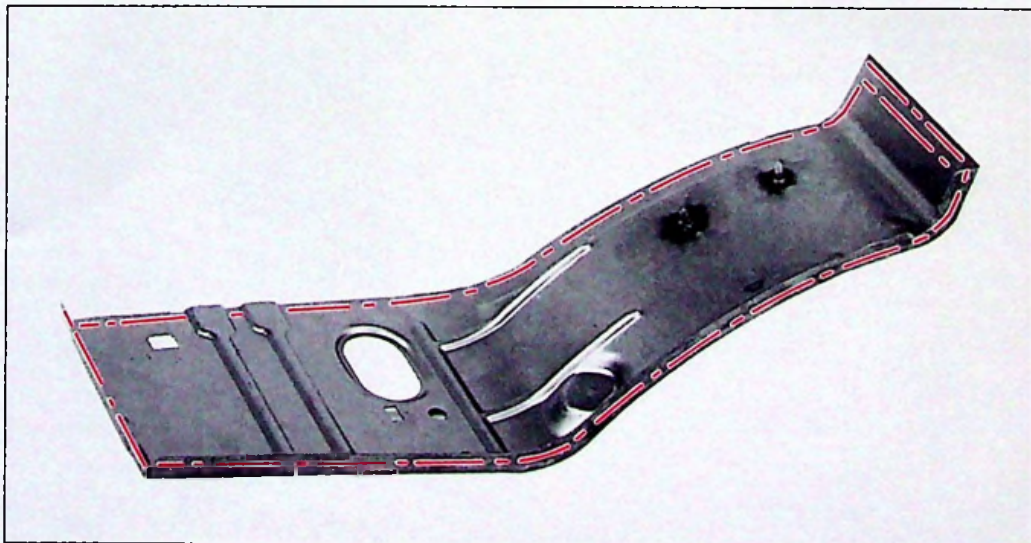

90-1135

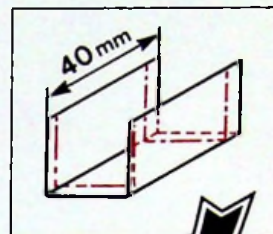
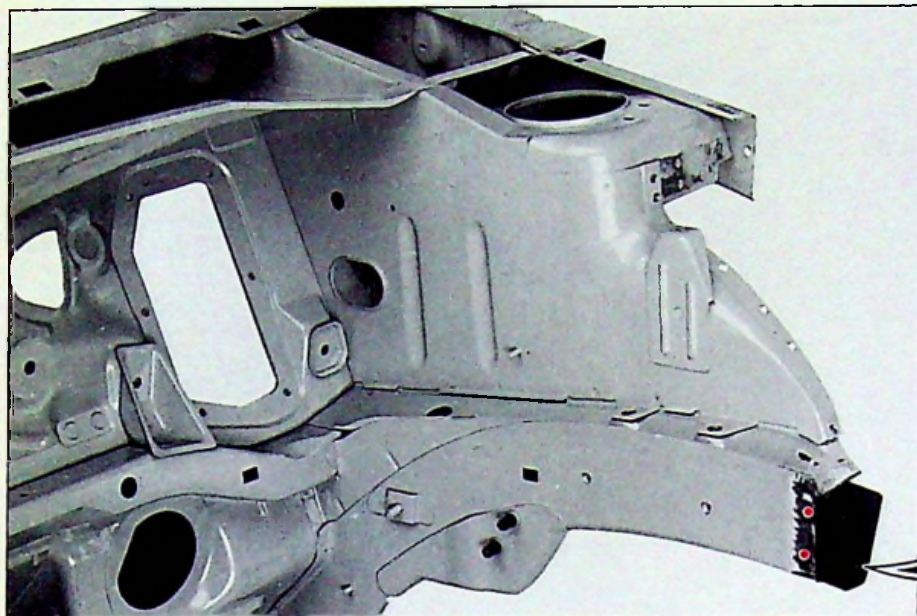
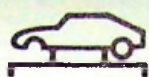

TT.82-4

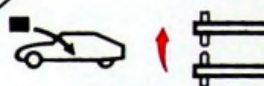

90-1207

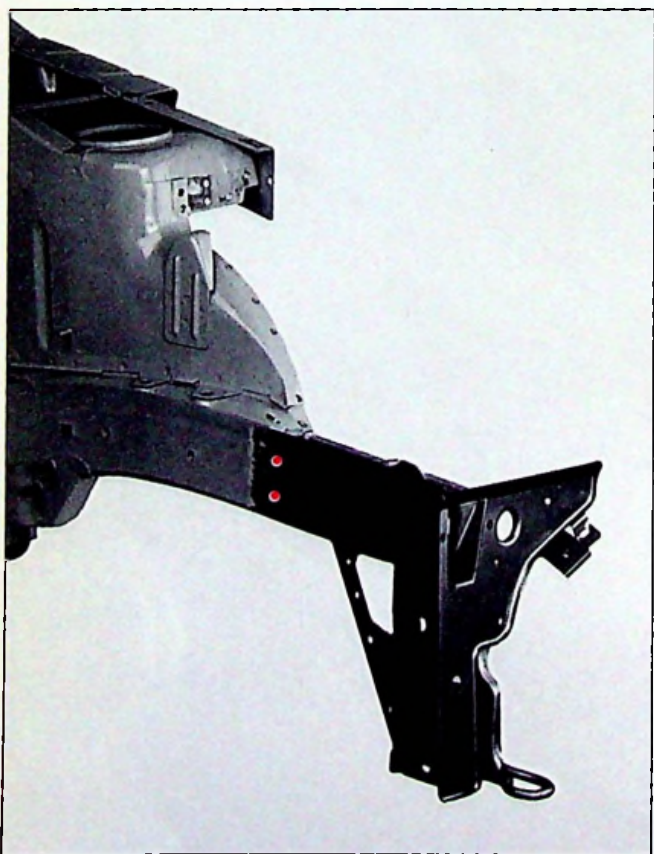

90-1208

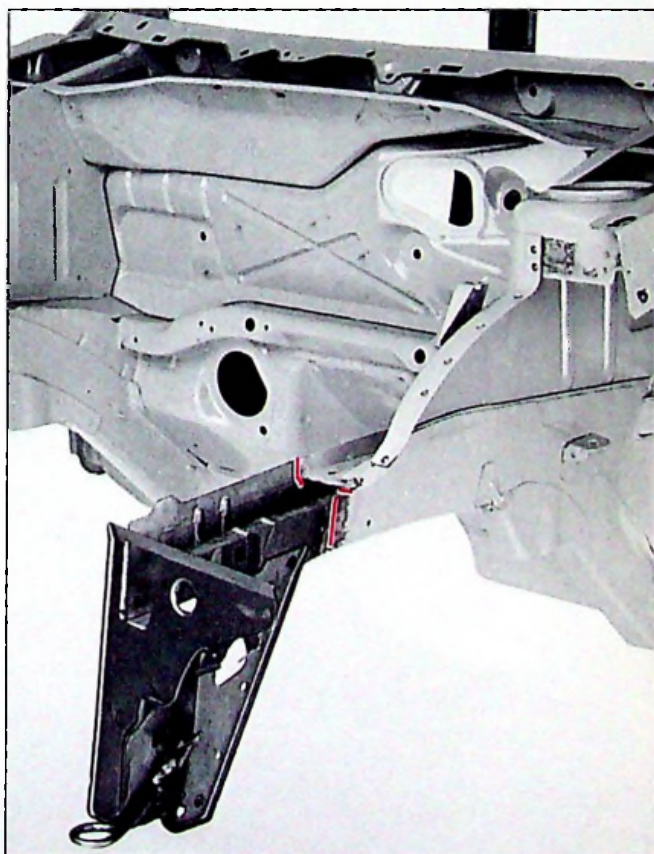
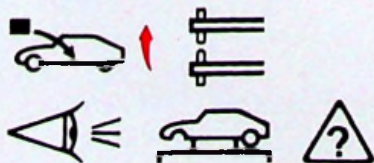

90-1211





14



ZX
801-3/4

7

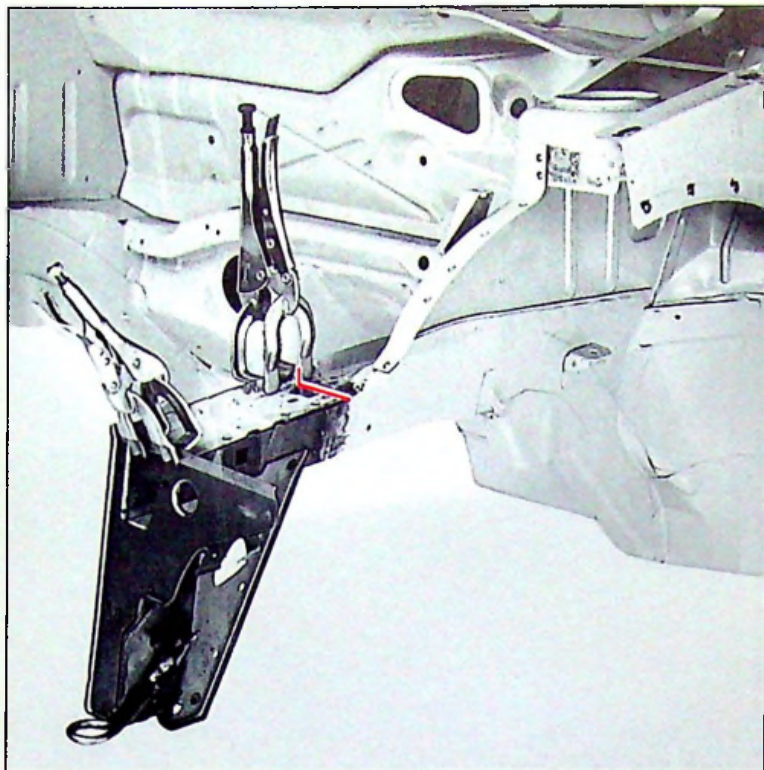

90-1210

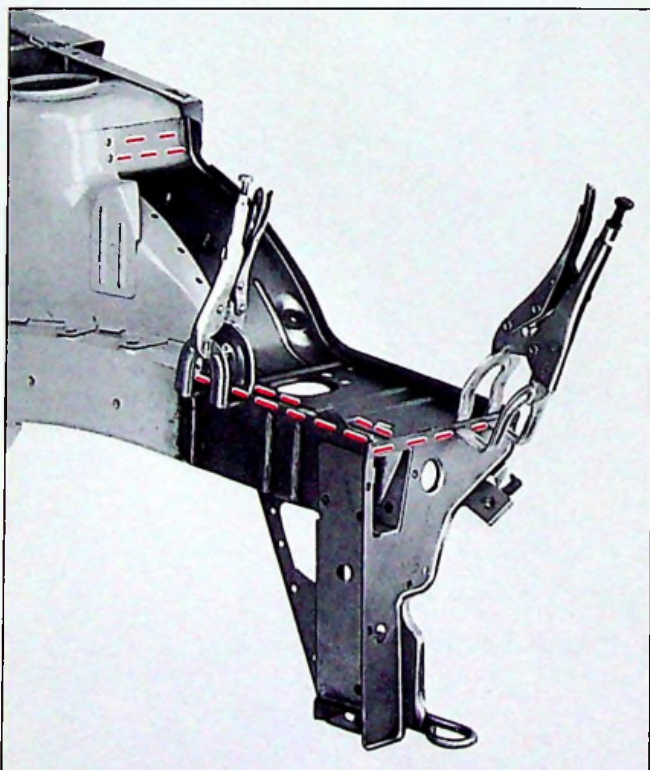

90-1209

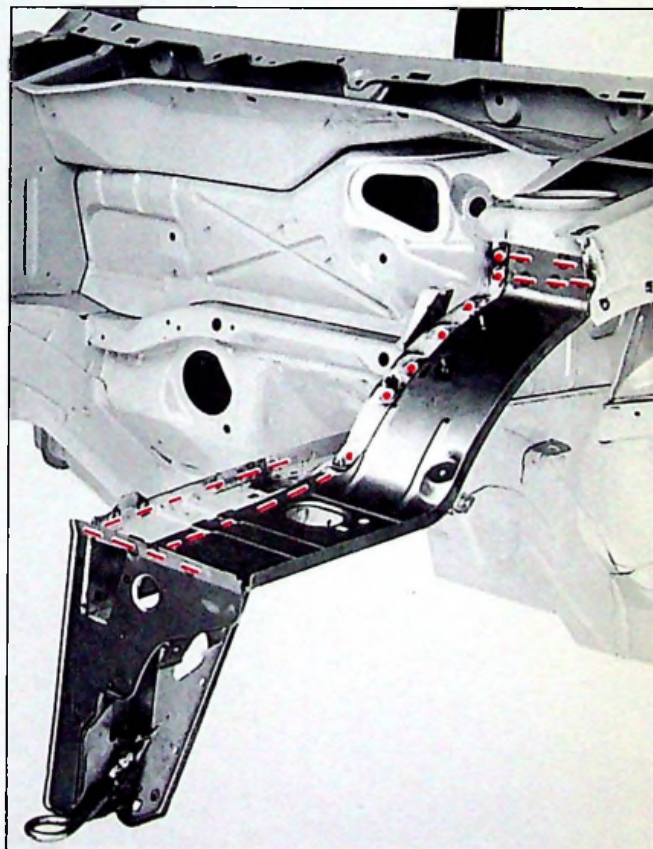

90-1212



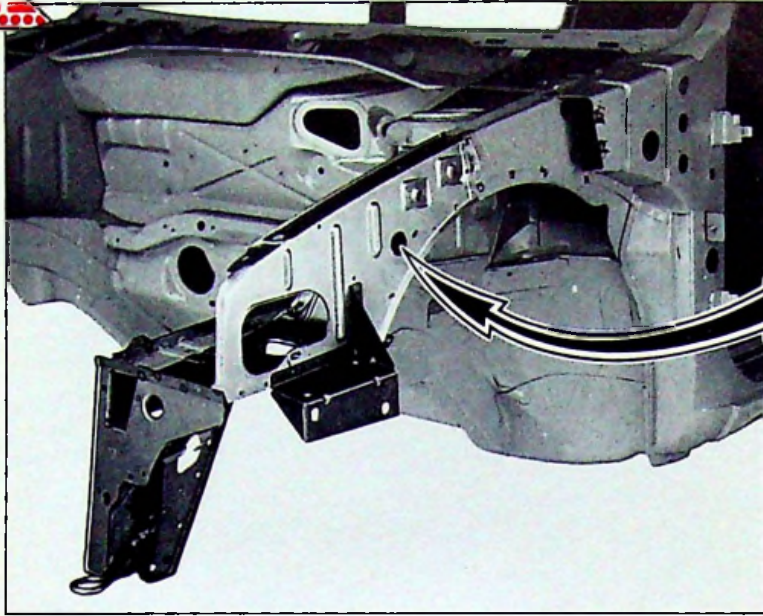
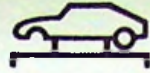

90-1213

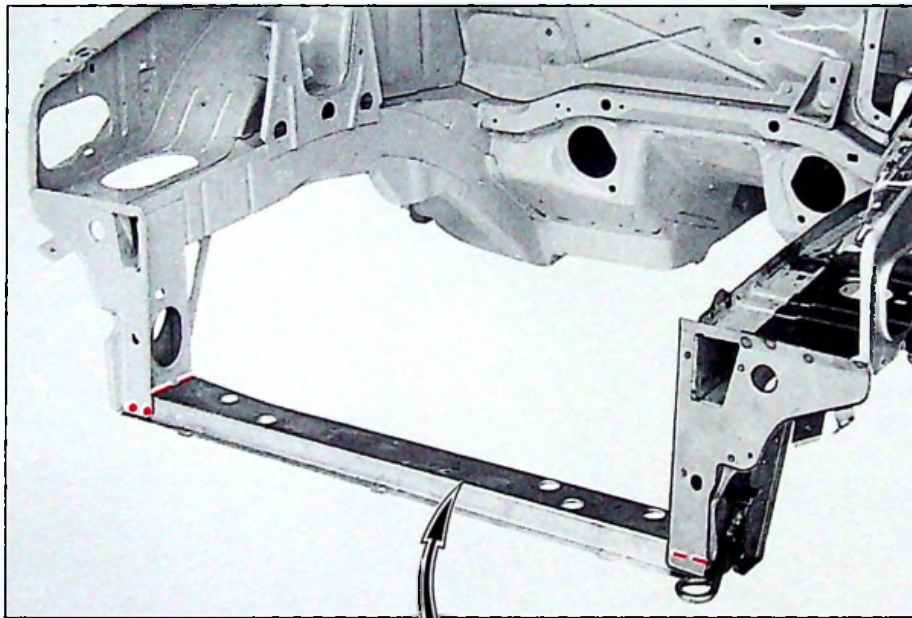

90-1216

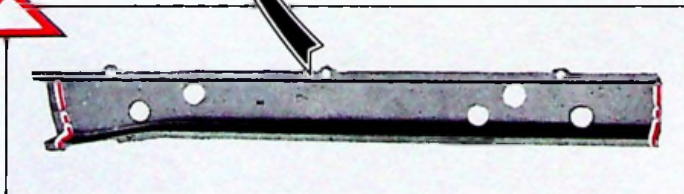

90-1136





14



ZX
801-3/4

9

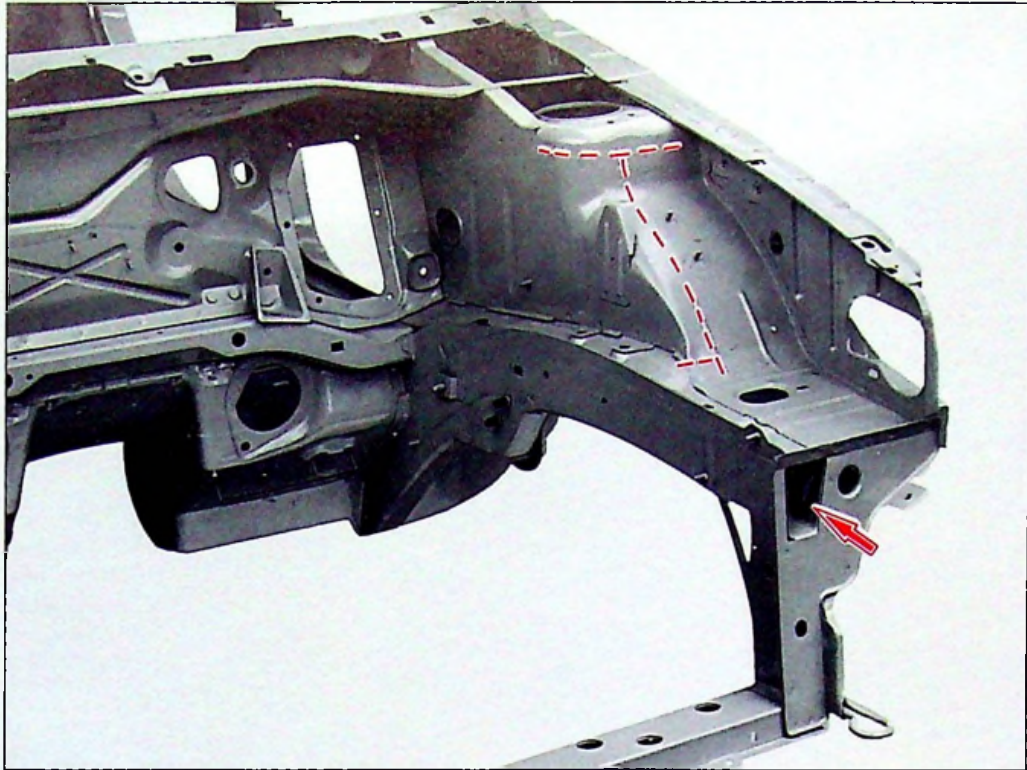

90-1074

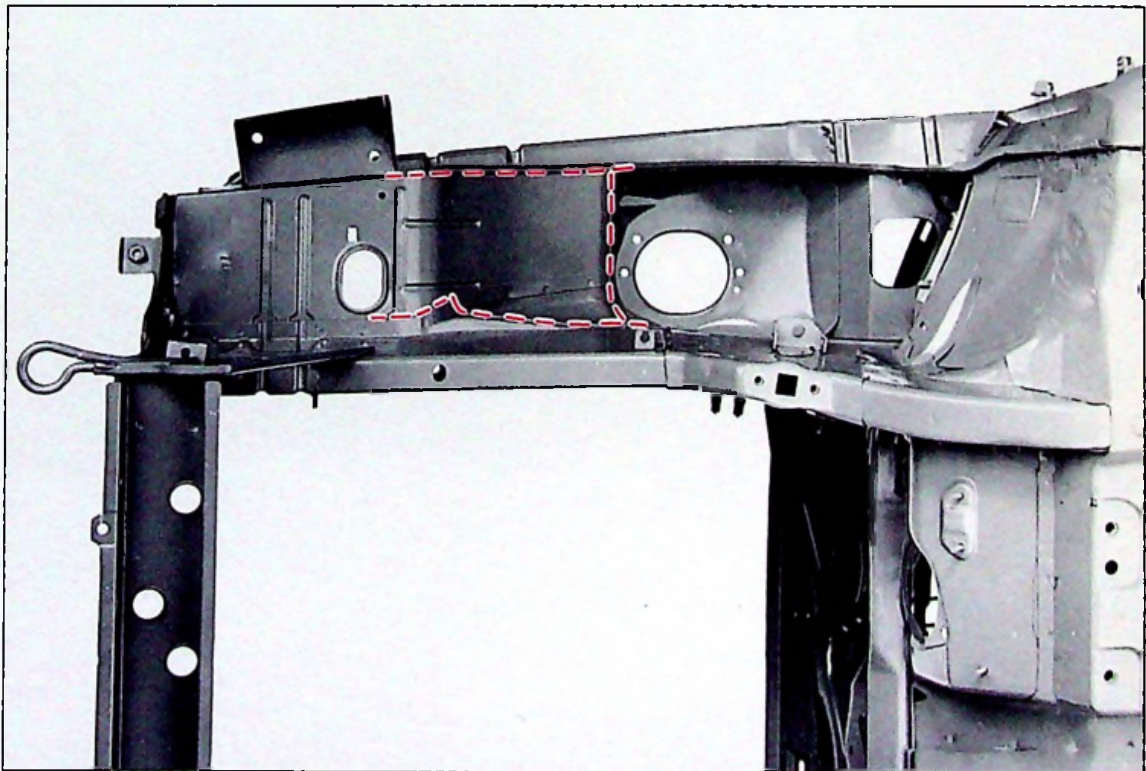
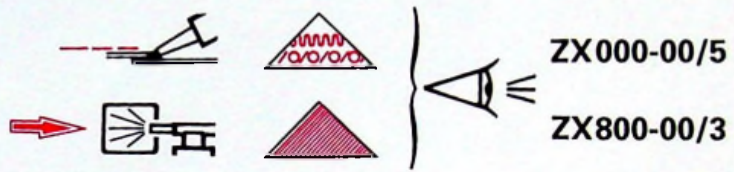

90-1071

CITROËN ZX

LE 31 JANVIER 1996

ABONNEMENT CAR

RÉF.

14

N° ZX 801-3/5

STRUCTURE

● PARTIE AVANT

Pose : Renfort sur support
de suspension

MAN 008943

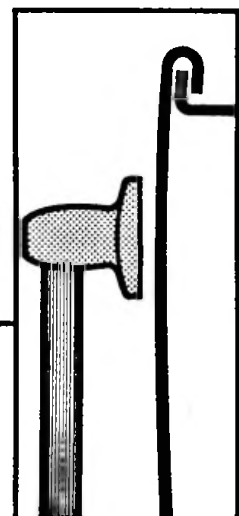

AUTOMOBILES CITROËN
DIRECTION COMMERCE EUROPE
DOCUMENTATION APRÈS VENTE

POSE : RENFORT SUR SUPPORT DE SUSPENSION

1 - OPERATIONS COMPLEMENTAIRES

Débrancher la borne négative de la batterie.

Déposer de chaque côté.

Dépose - repose :

- amortisseur avant
- garniture de passage de roue avant
- gaine et câble d'ouverture de capot

2 - IDENTIFICATION DES RENFORTS

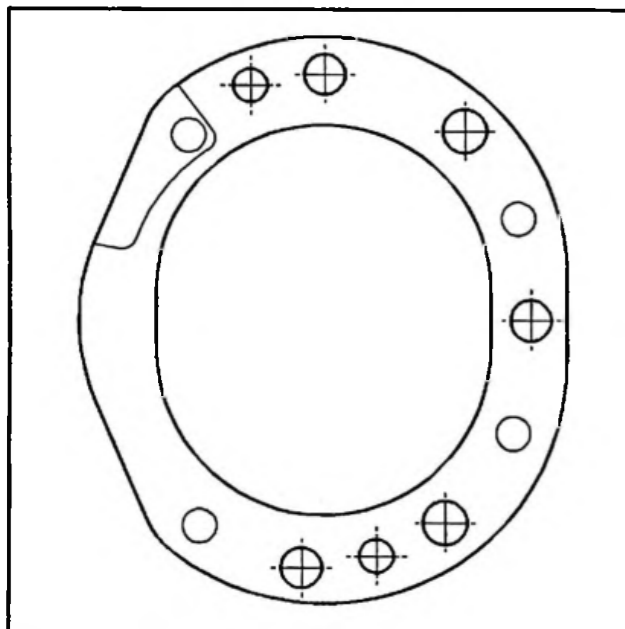

Fig : C4AP032C

Rondelle renfort supérieur.

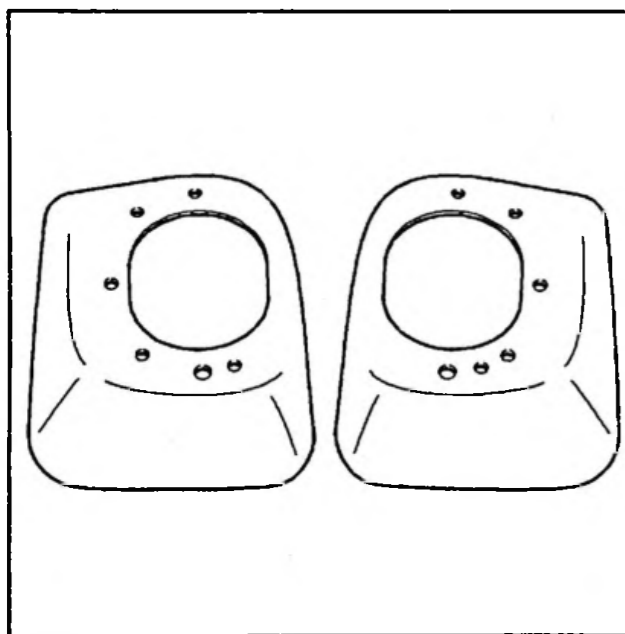

Fig : C4AP040C

Renforts intérieurs gauche et droit.

3 - NETTOYAGE

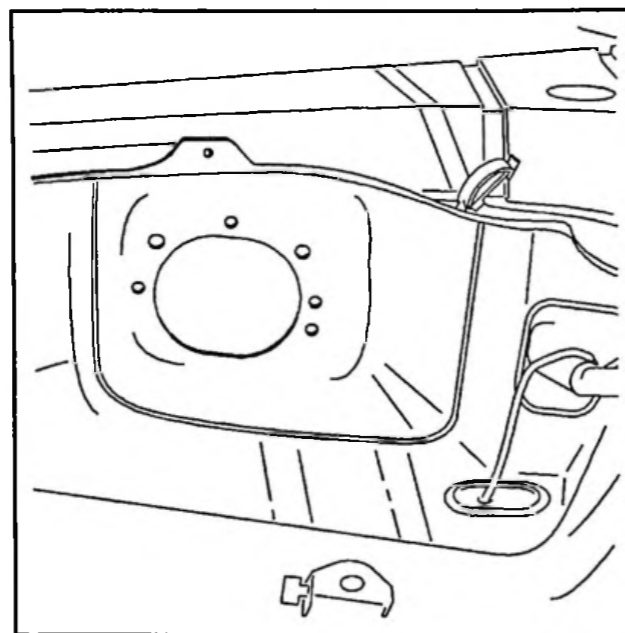

Fig : C4AP041C

Outillage préconisé :

- un chalumeau
- un grattoir
- une brosse métallique

Eliminer la protection sous caisse ainsi que la peinture.

L'intérieur du bol de suspension doit être propre pour réaliser des cordons de soudure correct.

4 - PREPARATION

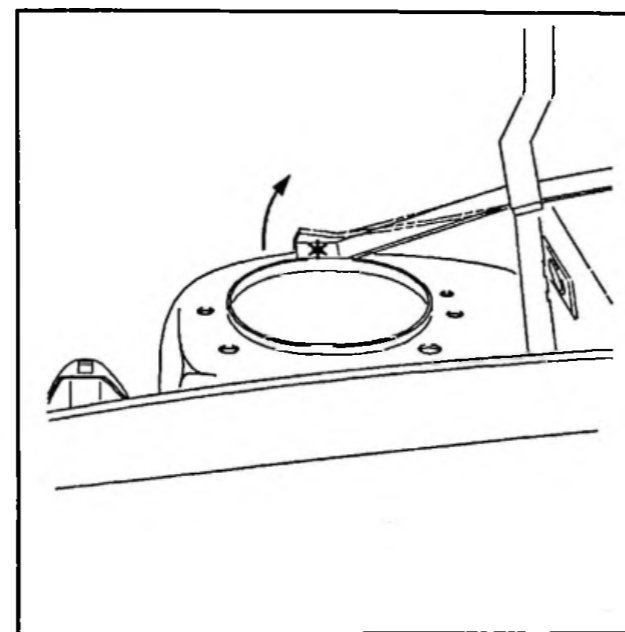

Fig : C4AP042C

Dégraffer le point de soudure électrique à l'aide d'une fraise $\varnothing = 8$ mm.

Relever le bord de liaison tôle d'auvent / bol de suspension.

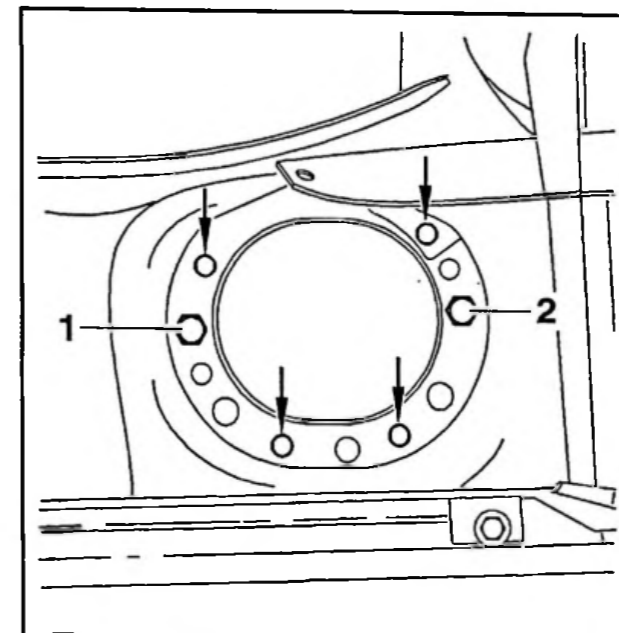

Fig : C4AP043C

Poser la rondelle renfort sur le bol de suspension en la glissant sous la liaison bol/tôle d'auvent.

Centrer correctement la rondelle renfort et la maintenir à l'aide des vis (1); (2).

Percer à $\varnothing = 10$ mm pour soudage par points "bouchon" (suivant flèches).

Déposer les vis (1); (2).

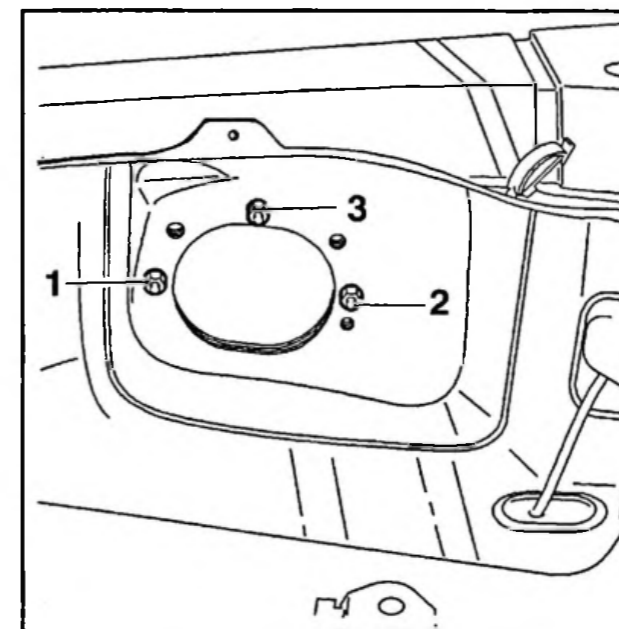

Fig : C4AP044C

Positionner le renfort intérieur, le maintenir à l'aide des vis (1 et 2).

Contre-percer le troisième point de fixation.

Fixer la vis (3).

5 - SOUDAGE

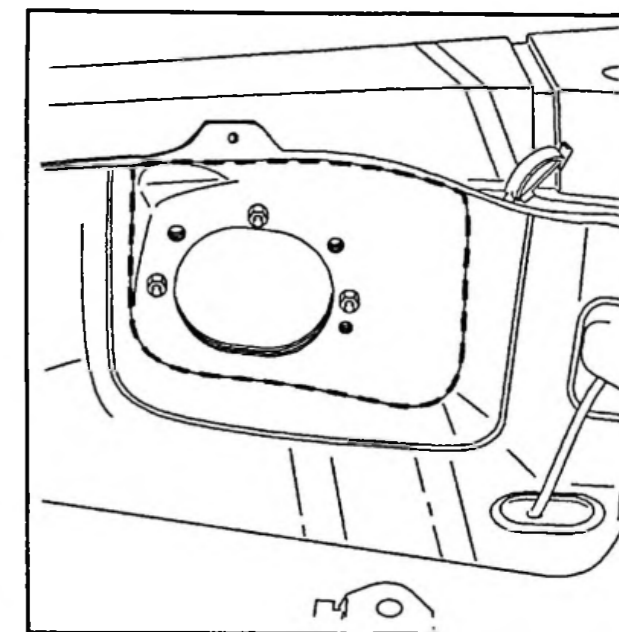

Fig : C4AP045C

Par l'intérieur du passage de roue, exécuter des cordons de soudure de 30 mm espacés de 30 mm (bagues $\varnothing 2,5$ mm ou $\varnothing 3,2$ mm).

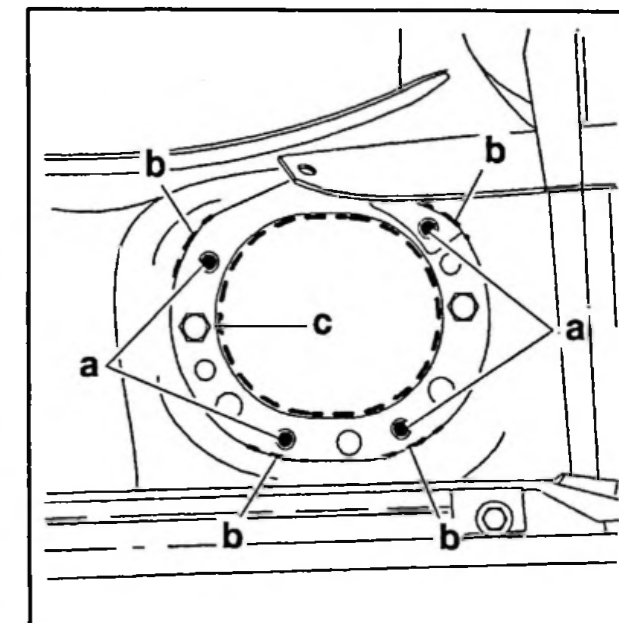

Fig : C4AP046C

Par le dessus du passage de roue, exécuter les soudures suivantes (bagues $\varnothing 2$ mm ou $\varnothing 2,5$ mm) :

- 4 points bouchons (a)
- 4 cordons de soudure (b) d'une longueur de 30 mm pour relier la rondelle renfort au bol de suspension en correspondance avec les points bouchons
- 1 cordon de soudure continu (c)

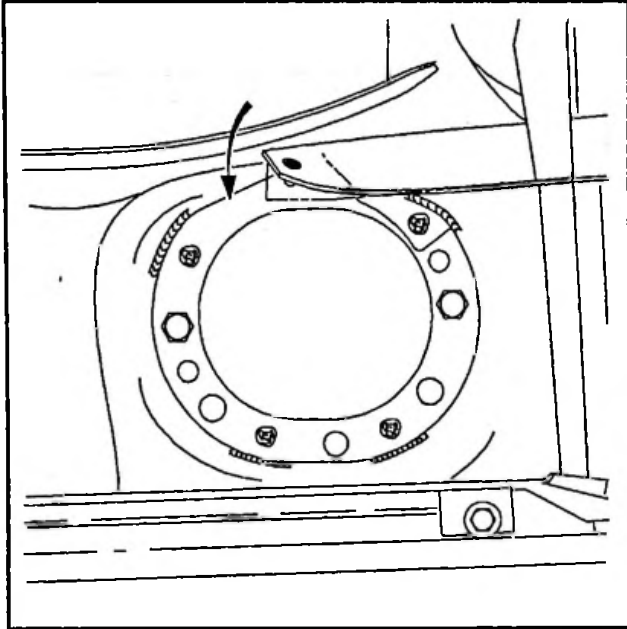

Fig : C4AP047C

Rabattre le bord de liaison tôle auvent bol de suspension, faire un point bouchon.

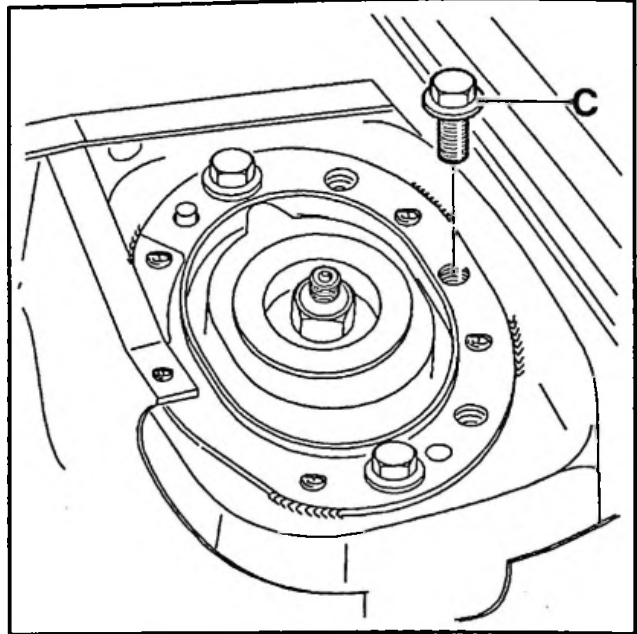

Fig : C4AP049C

Poser et serrer la vis (C) à 3 m.daN.

6 – FINITION

Nettoyer l'intérieur et l'extérieur du bol de suspension, et éliminer toutes traces de projections soudure.

7 – PROTECTION

Appliquer une couche d'antigravillonnage :

- sur la face intérieure du bol de suspension (protéger la tête d'amortisseur)
- sur la face supérieure du bol de suspension

Après séchage de l'antigravillonnage, peindre le bol de suspension (protéger l'environnement).

Brancher la batterie.

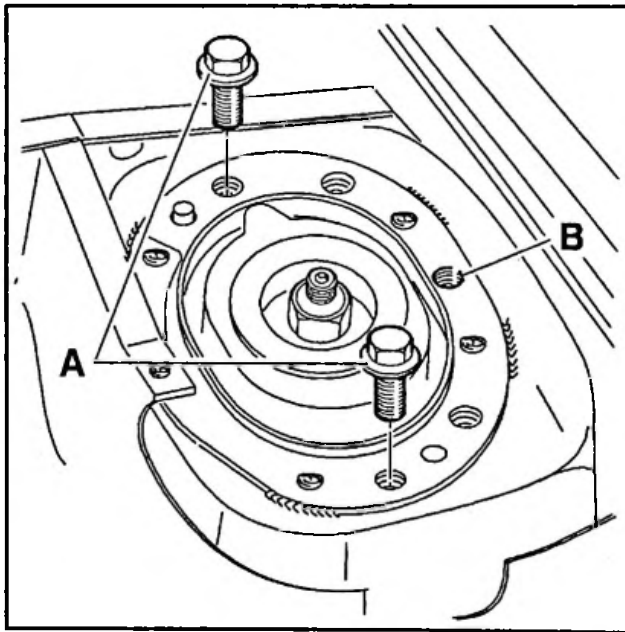

Fig : C4AP048C

Reposer l'amortisseur.

Poser et serrer les vis (A) à 3 m.daN (vis "A" avec rondelle imperdable).

Percer un trou "B" de Ø 6,75 mm débouchant dans le support amortisseur.

Tarauder le trou "B" à M8 x 125.

IMPERATIF : Tenir compte de cette modification lors d'un éventuel passage au banc (mécanique déposée).



14

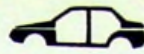

ZX
821-3/1

1

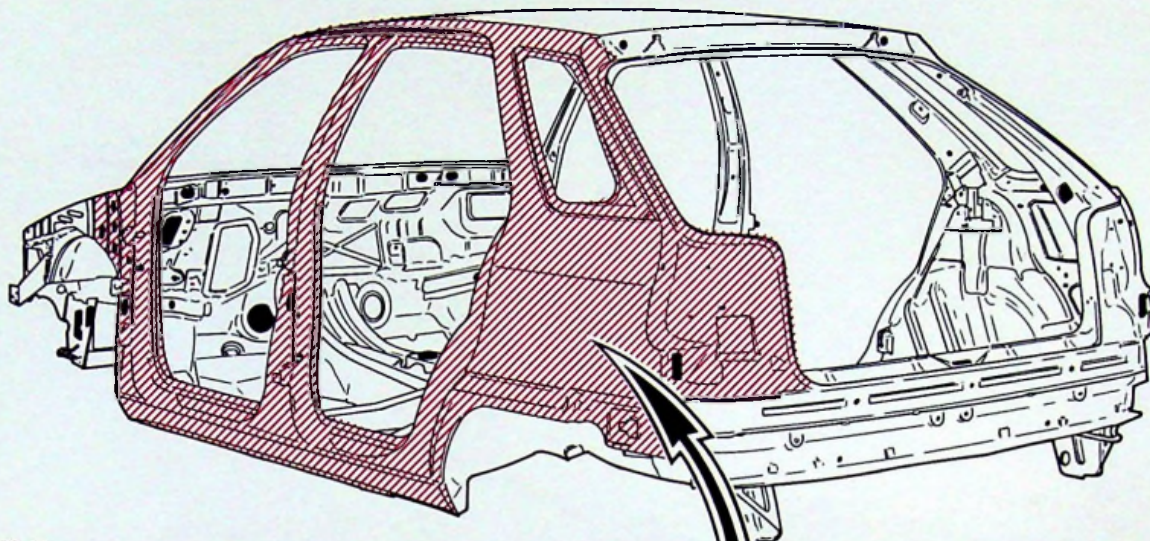

F.80-11

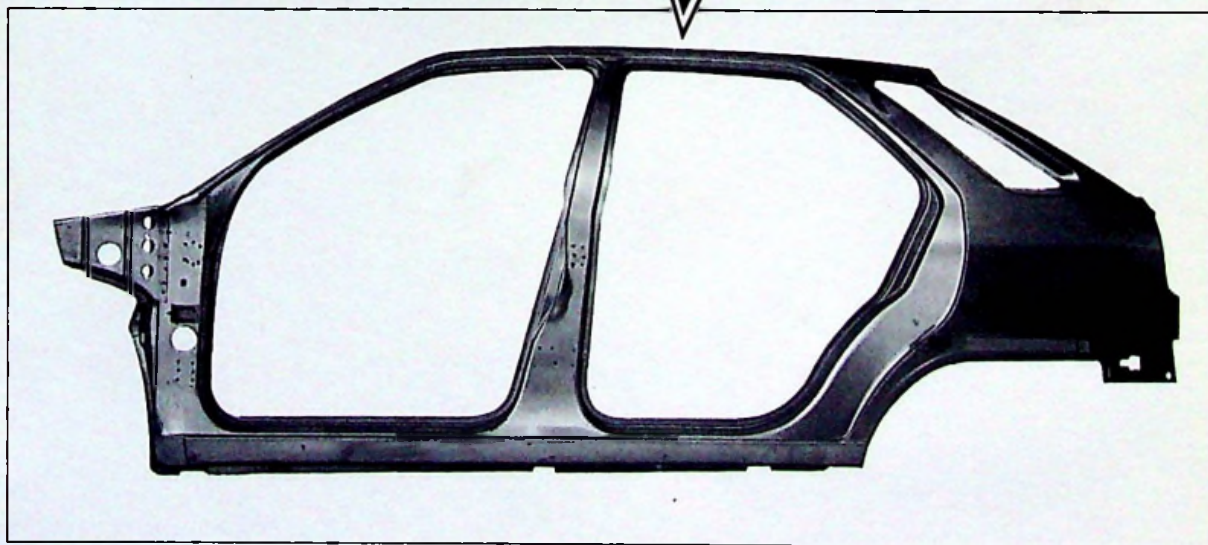

90-1160

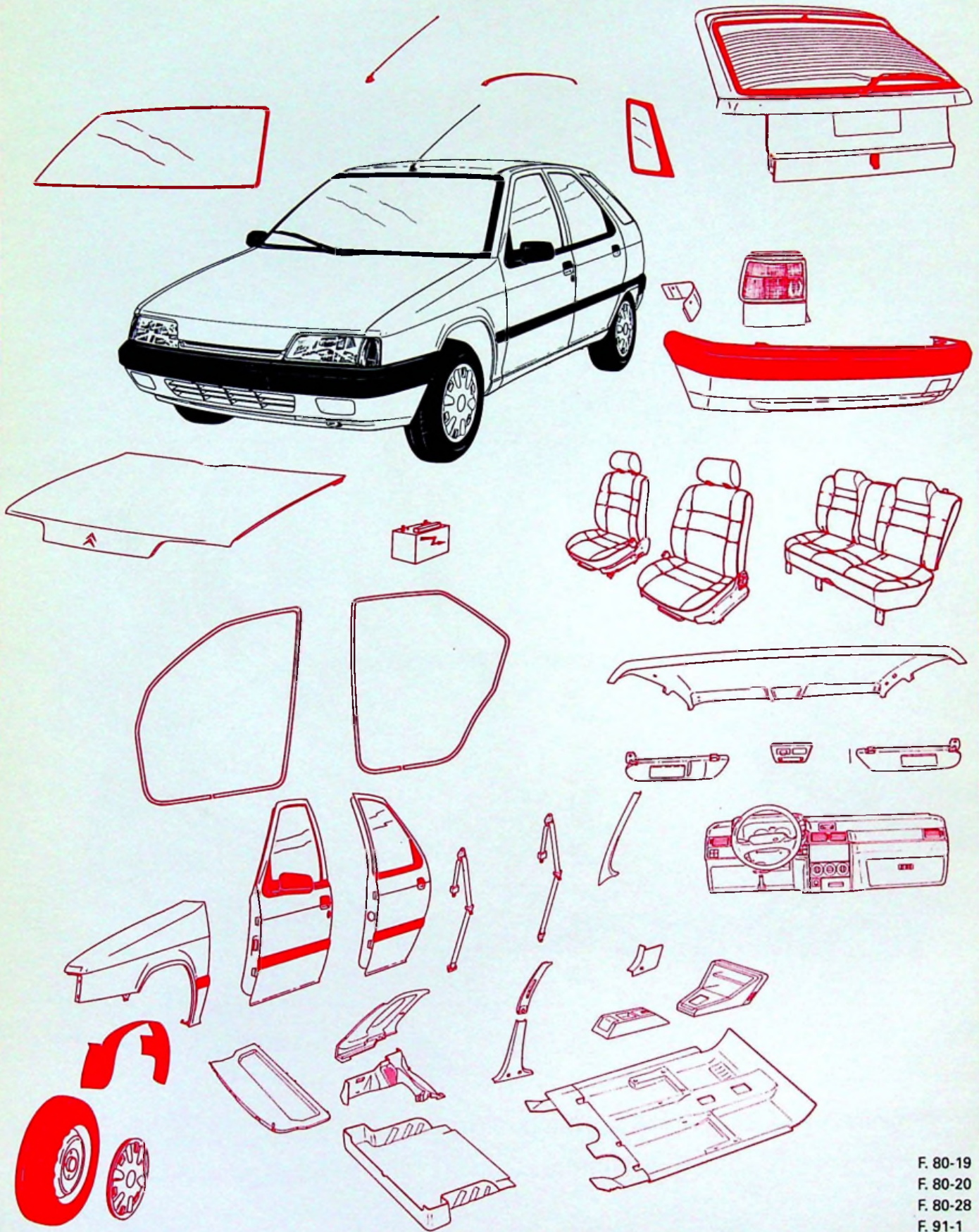
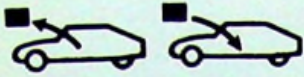

F. 80-19
F. 80-20
F. 80-28
F. 91-1



14

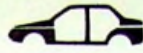

ZX
821-3/1

3

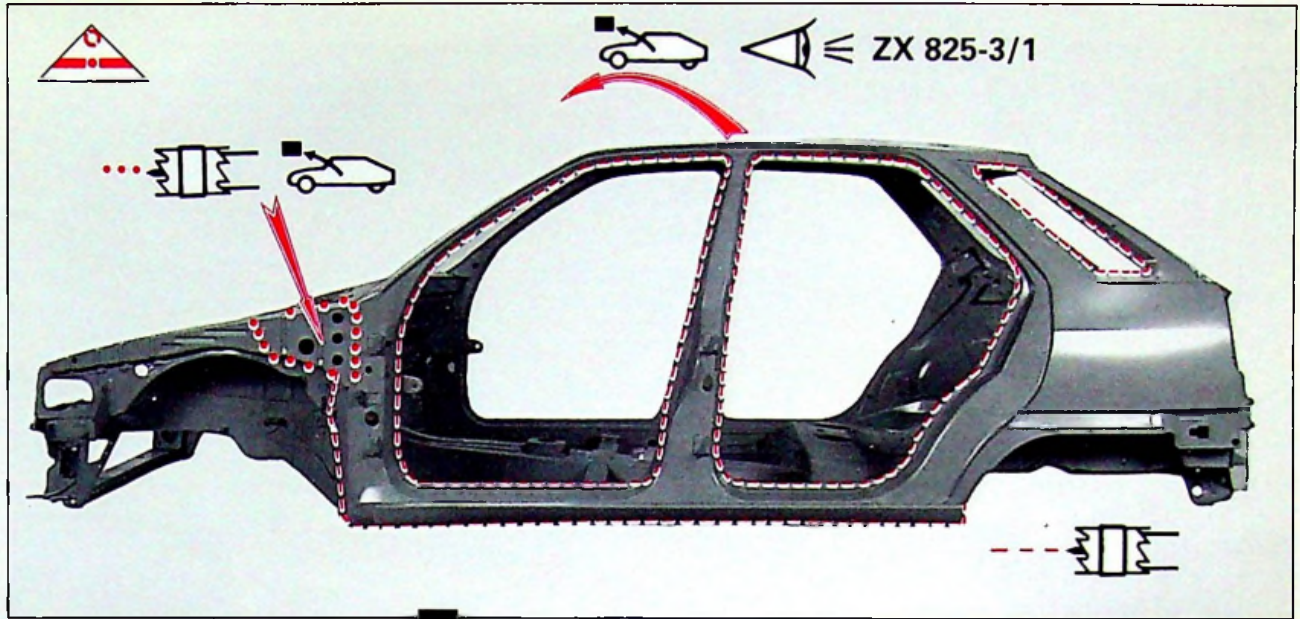

90-1084

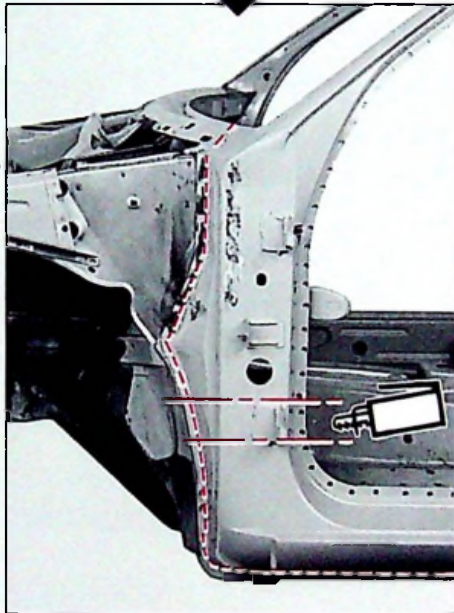

90-1666



90-1678

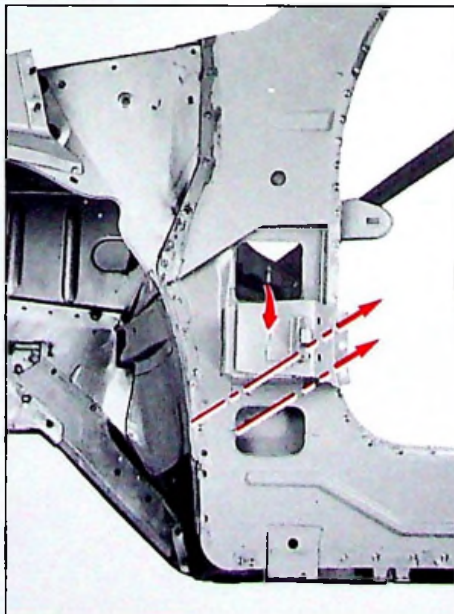

90-1679

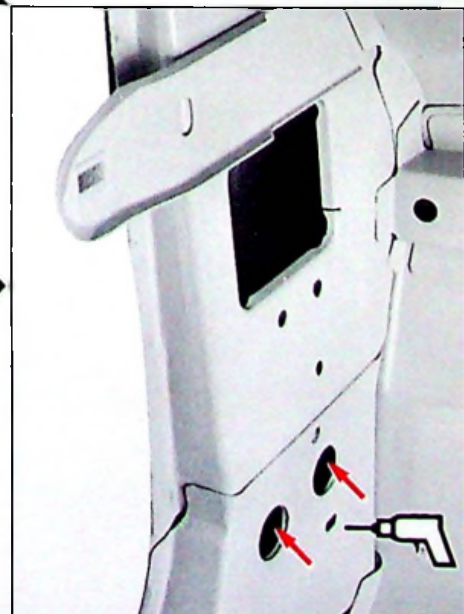

90-1774

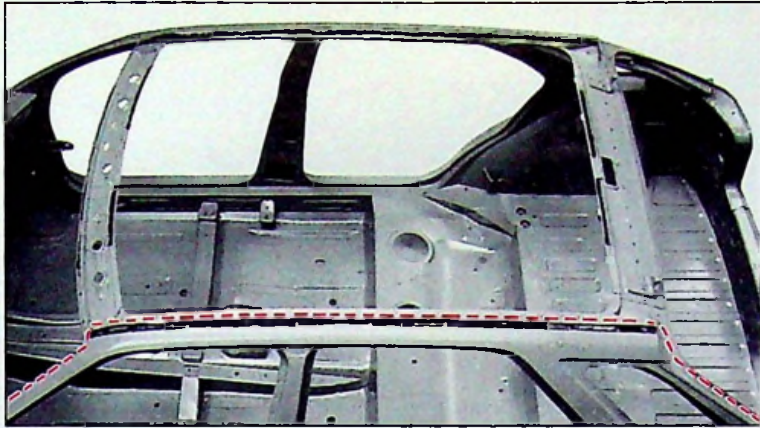

90-1229

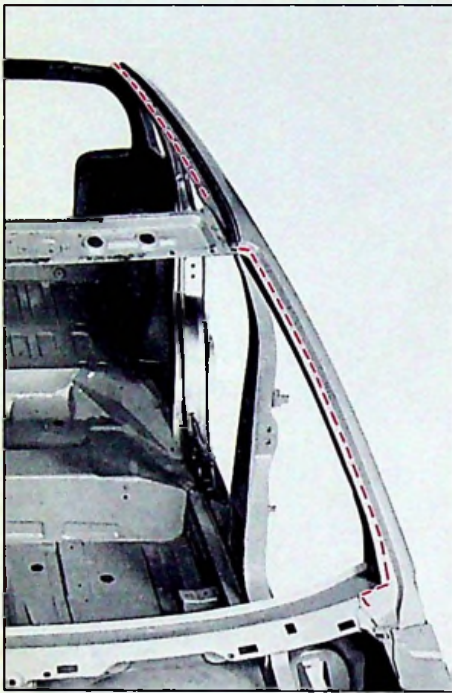

90-1242



90-1241

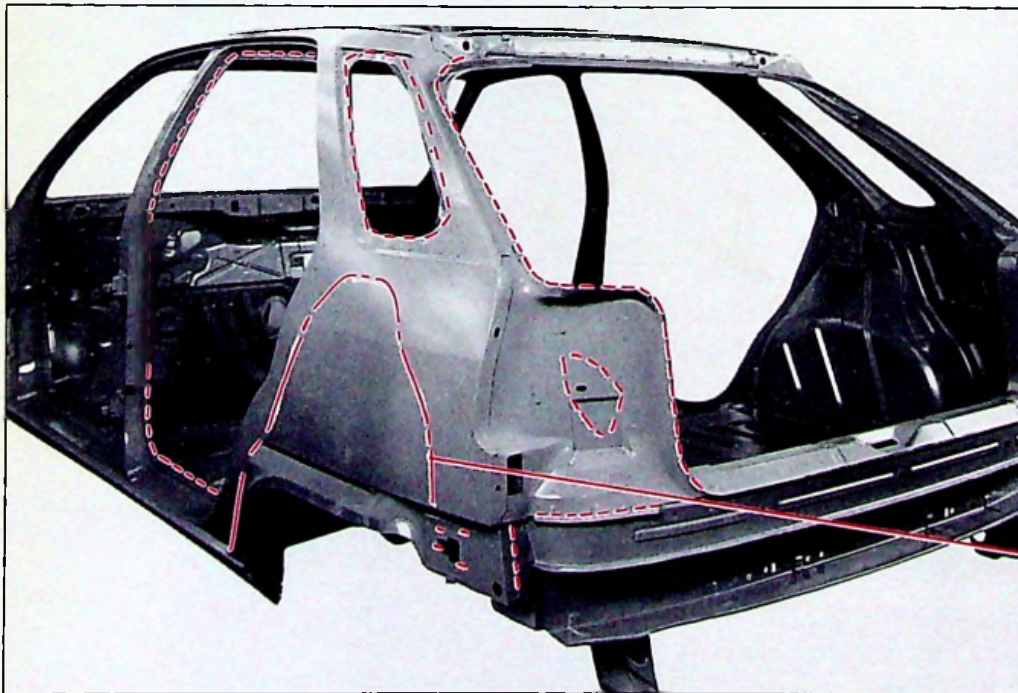

90-964

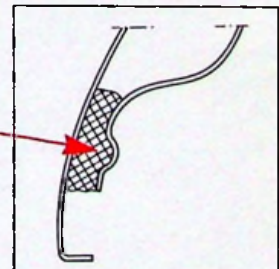
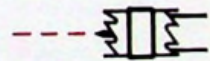

TT. 82-5



14



ZX
821-3/1

5

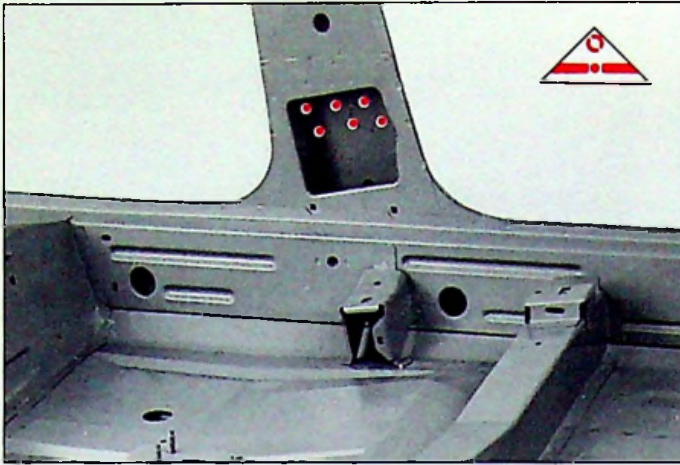

90-1095

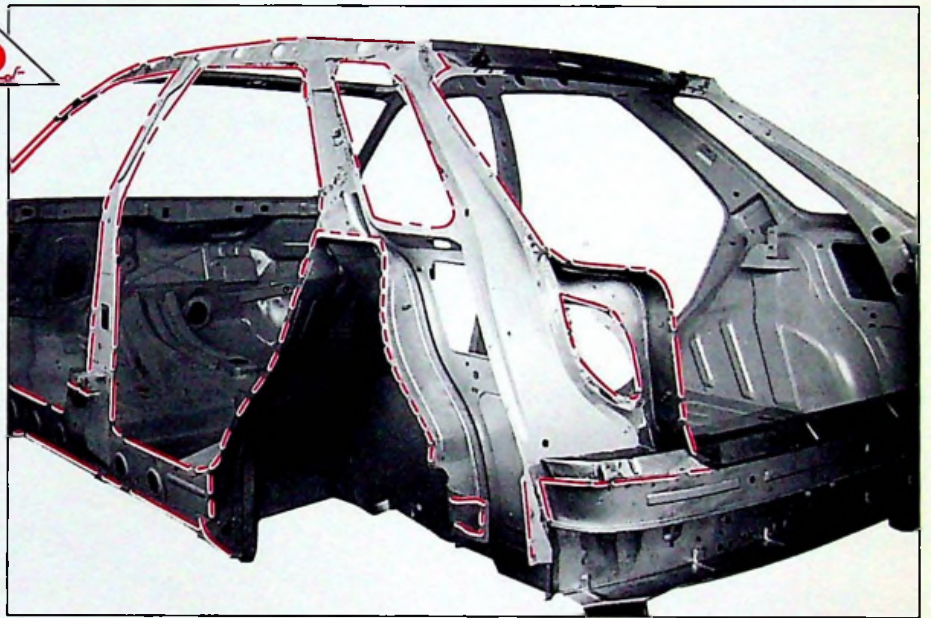
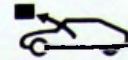
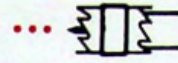

90-1775

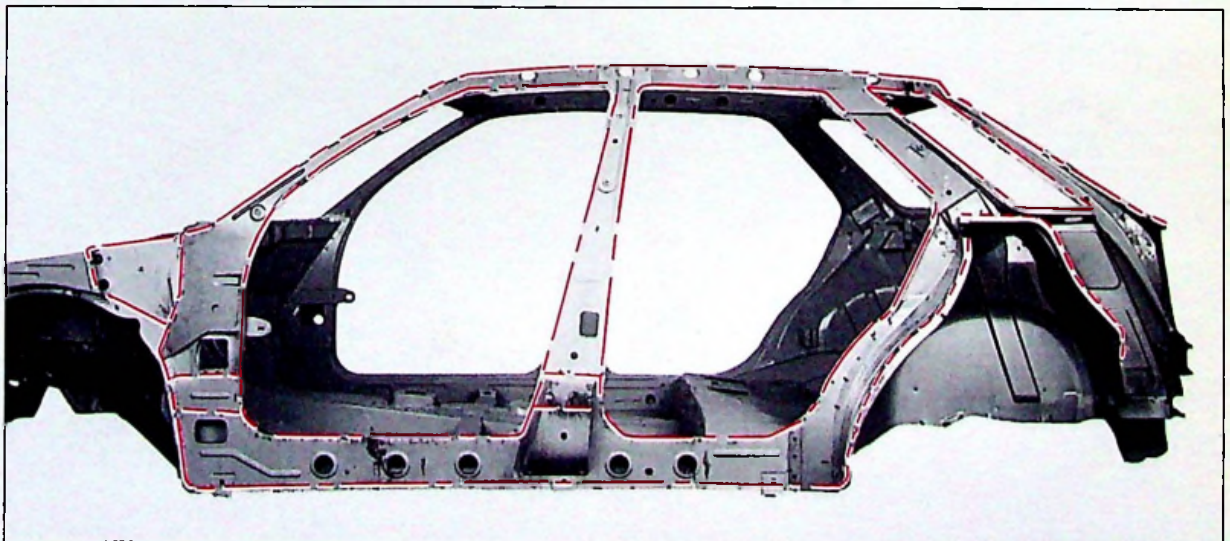

90-1776

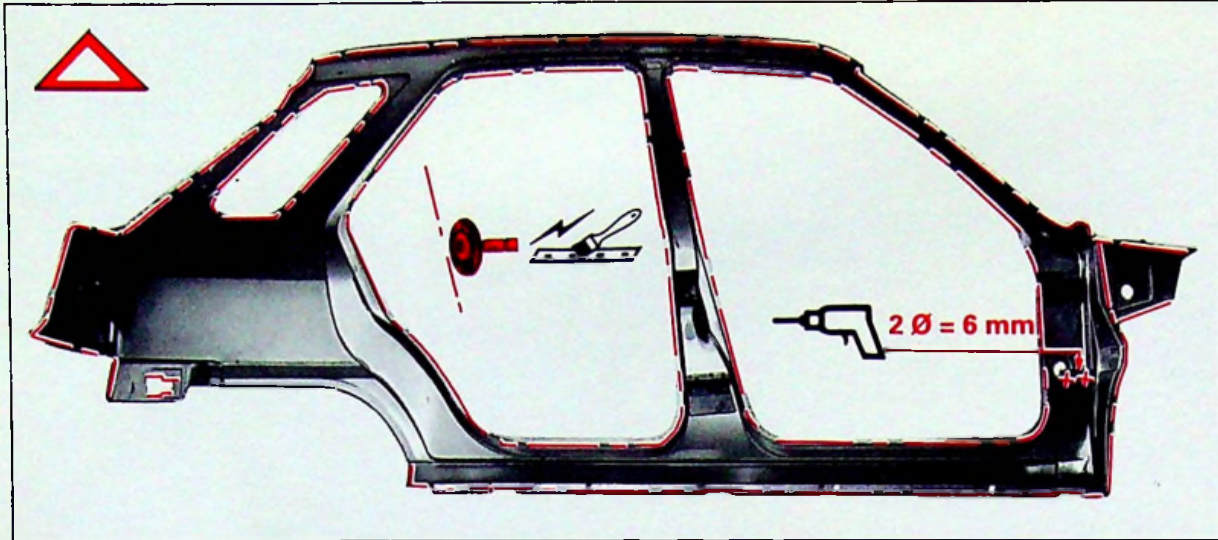

90-1159

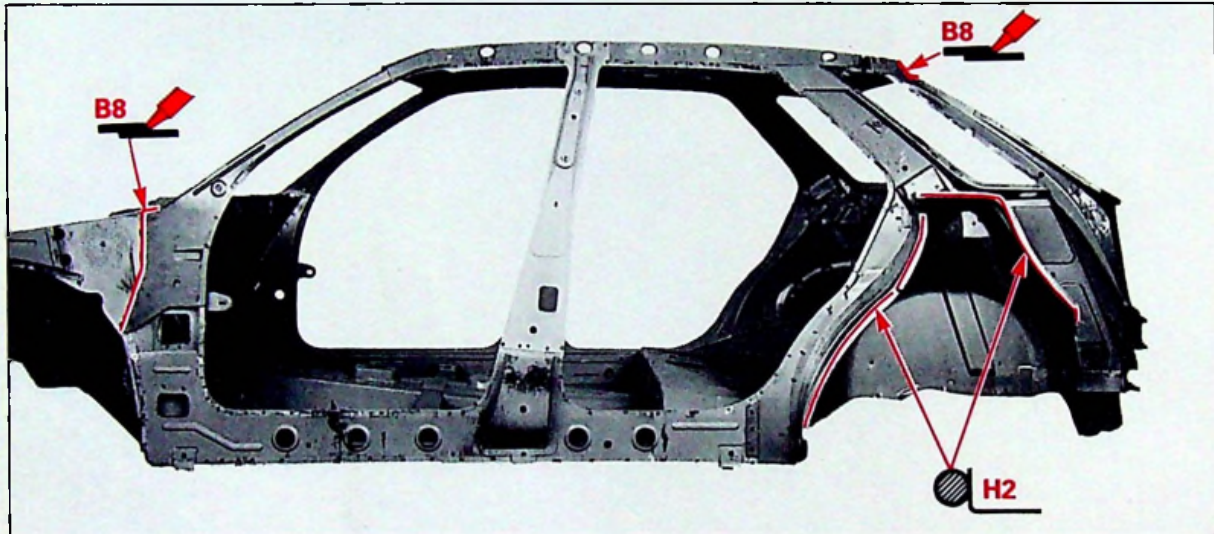

90-1776

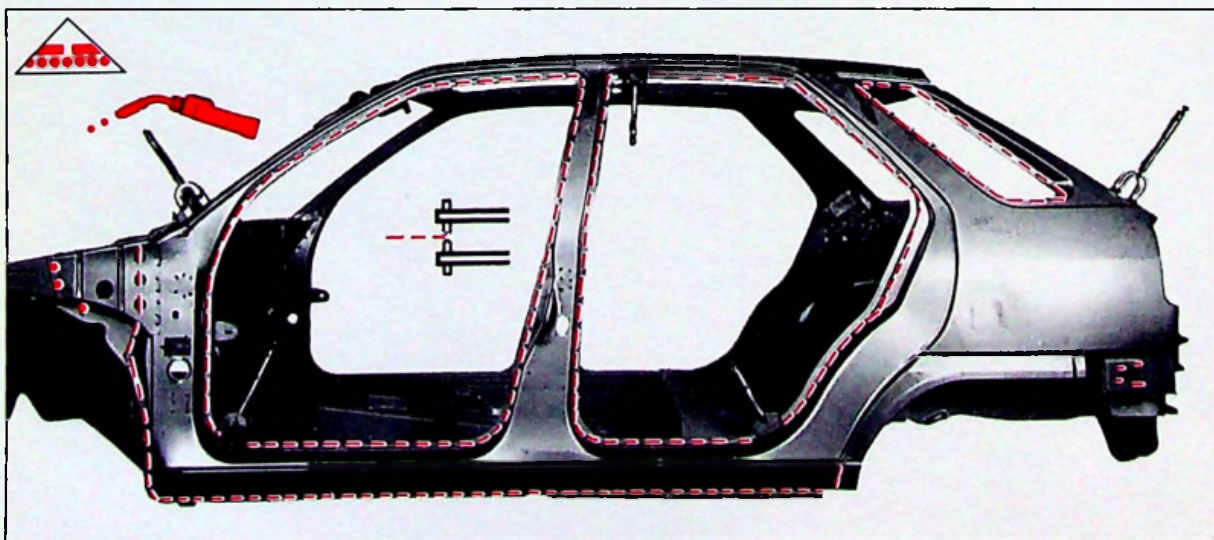

90-1777



14



ZX
821-3/1

7



90-1242

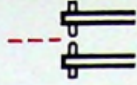

90-1241

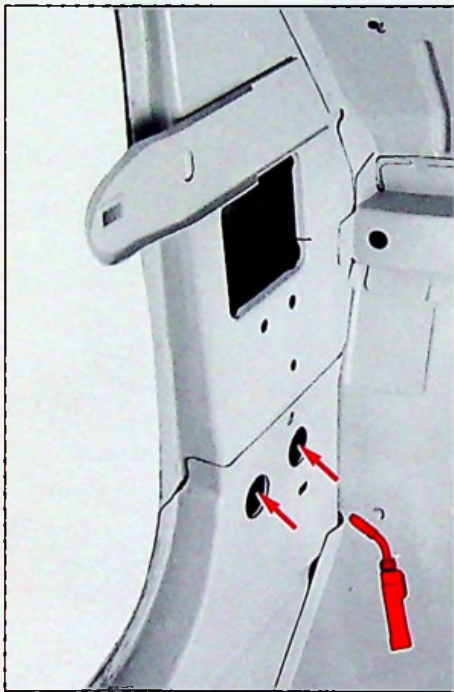

90-1774

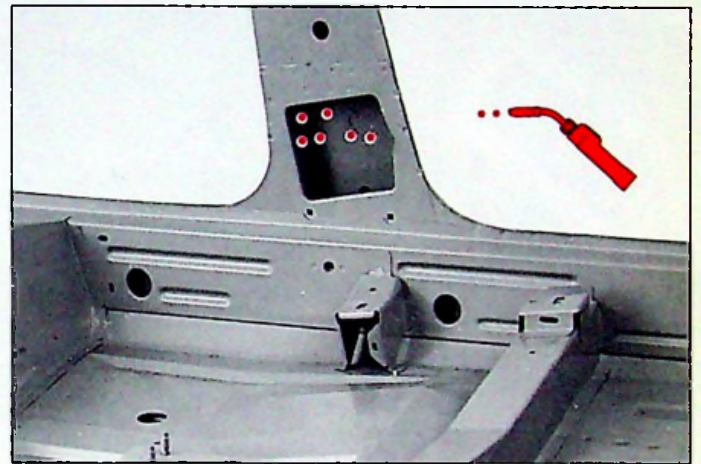

90-1095

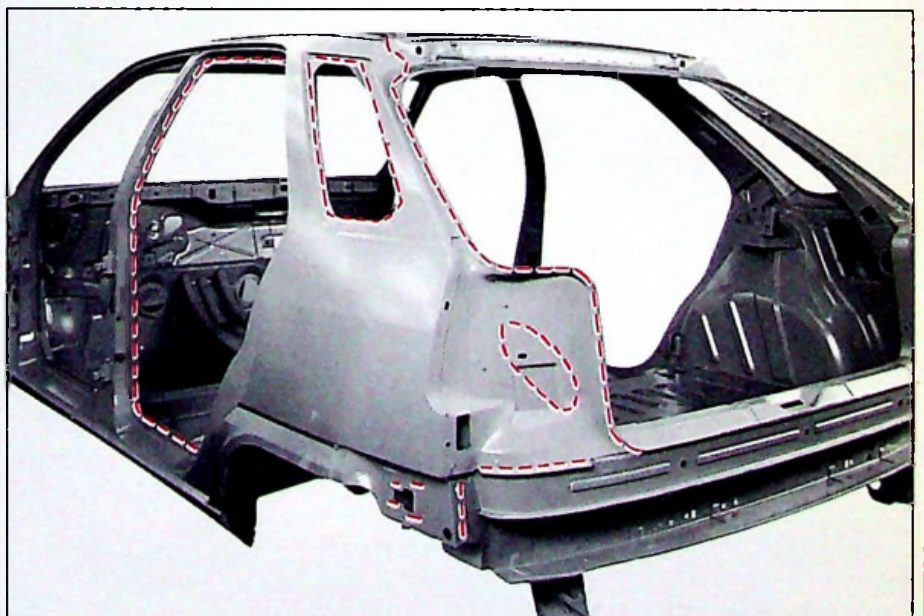
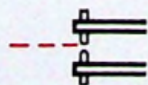

90-964



ZX 825-3/1

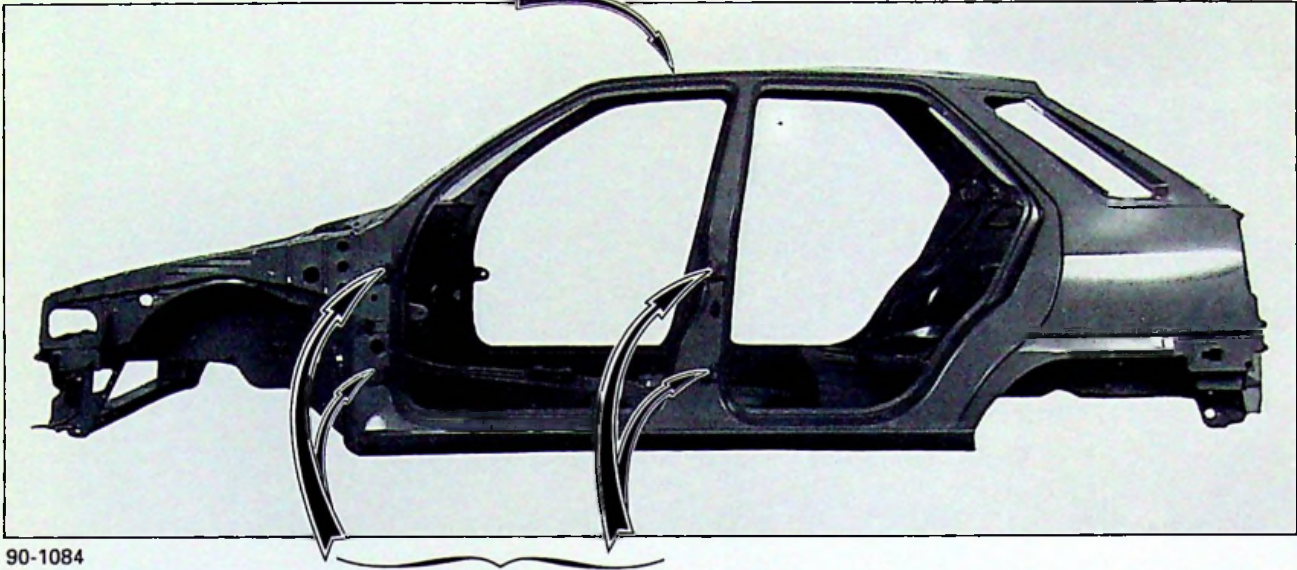

90-1084

ZX 821-3/2



90-1401



A1



C1



90-1088



14



ZX
821-3/1

9



90-1092

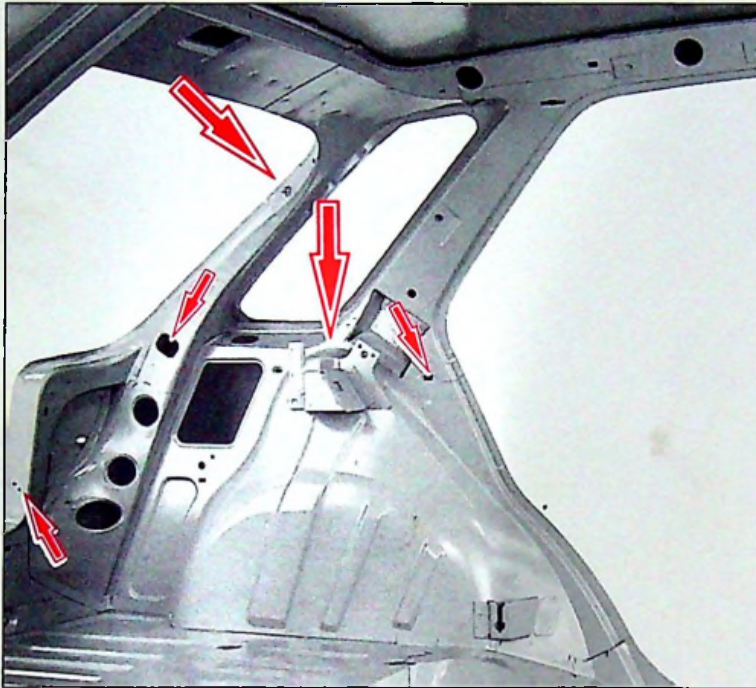

90-1098

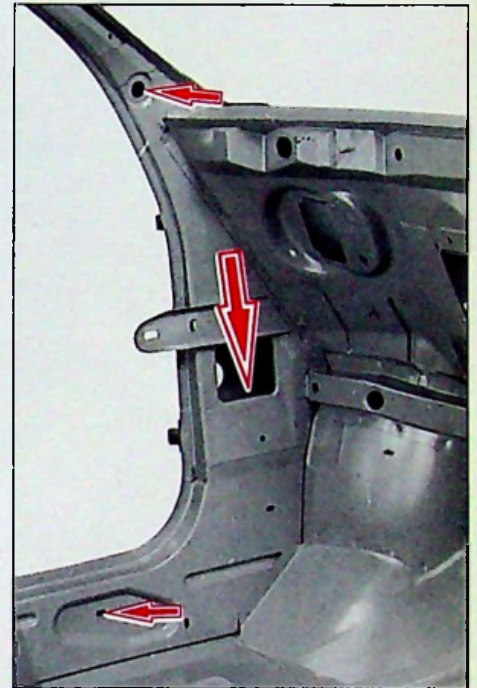

90-1076



90-1072

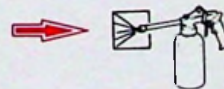

ZX 000-00/5
ZX 800-00/3



14



ZX
821-3/2

1

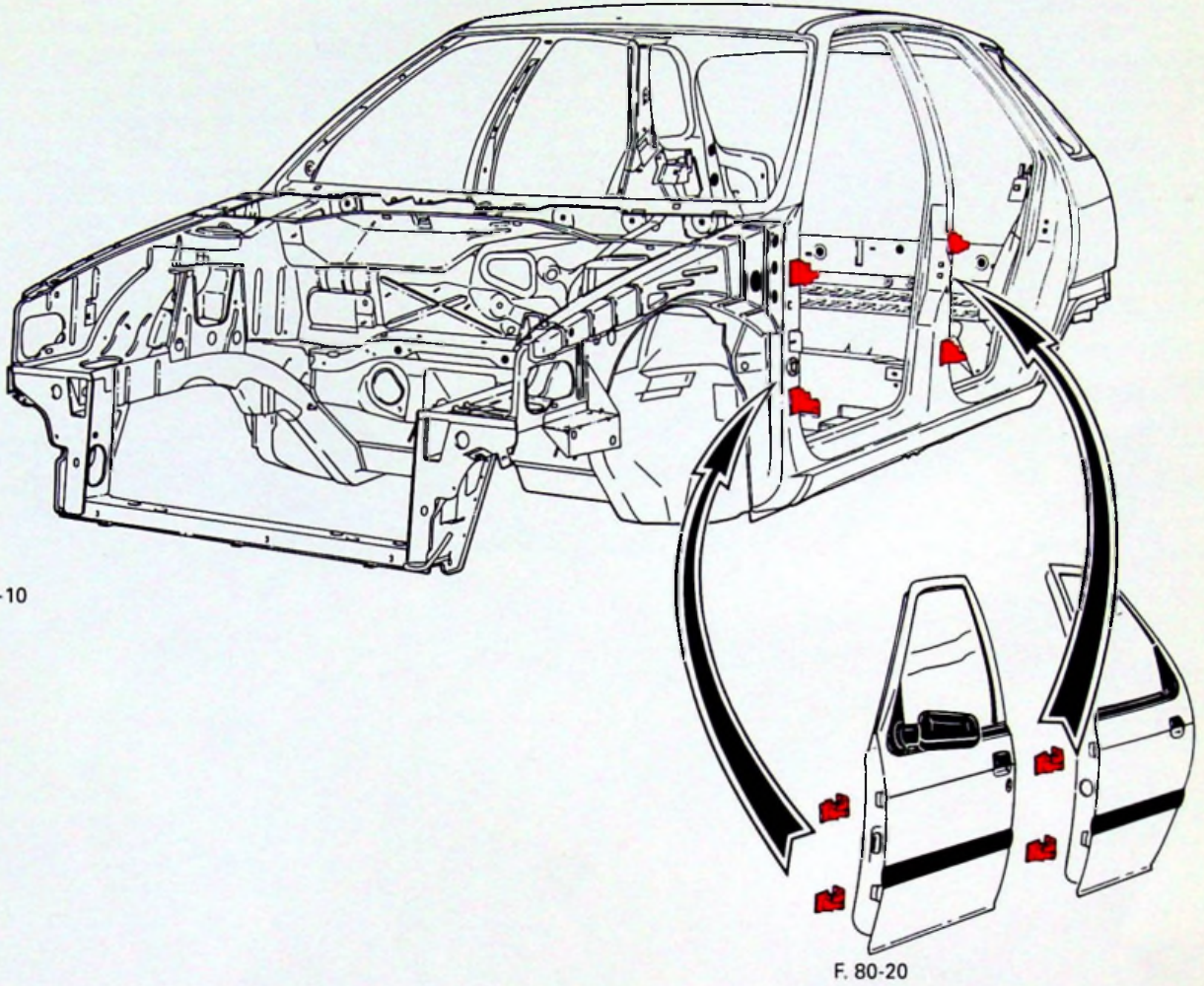

7501-T



82-1353 (x 4)

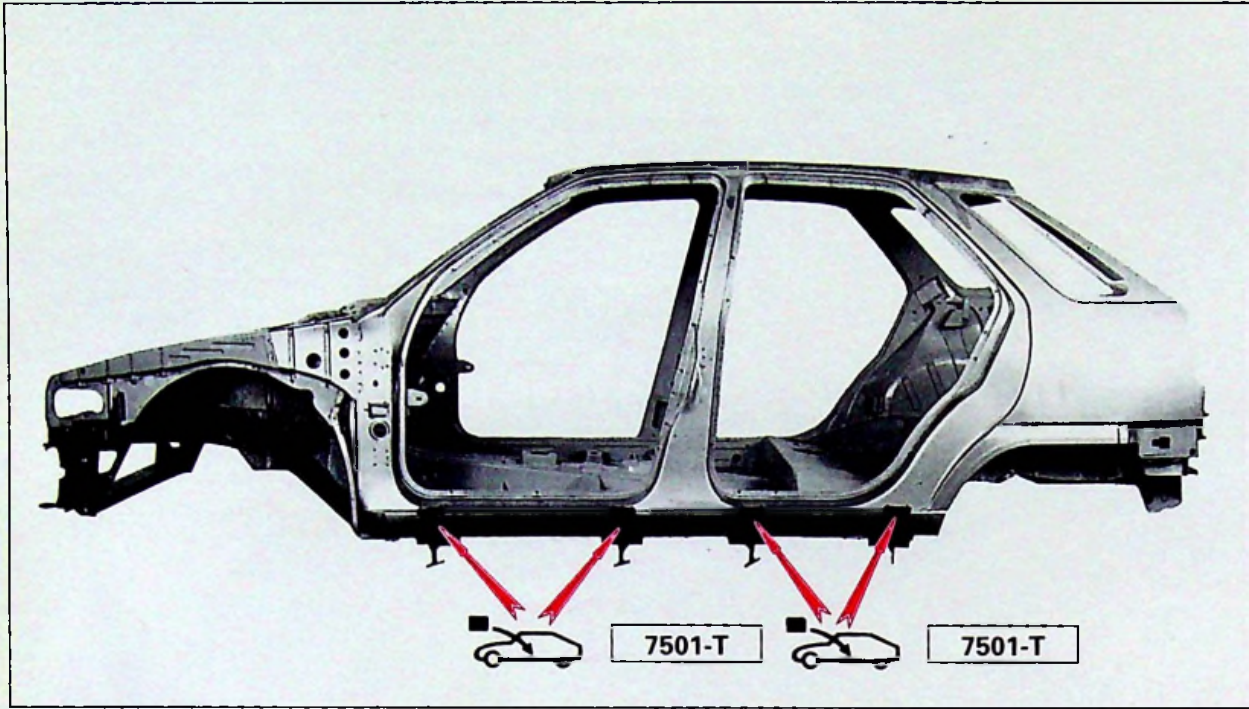

90-1803

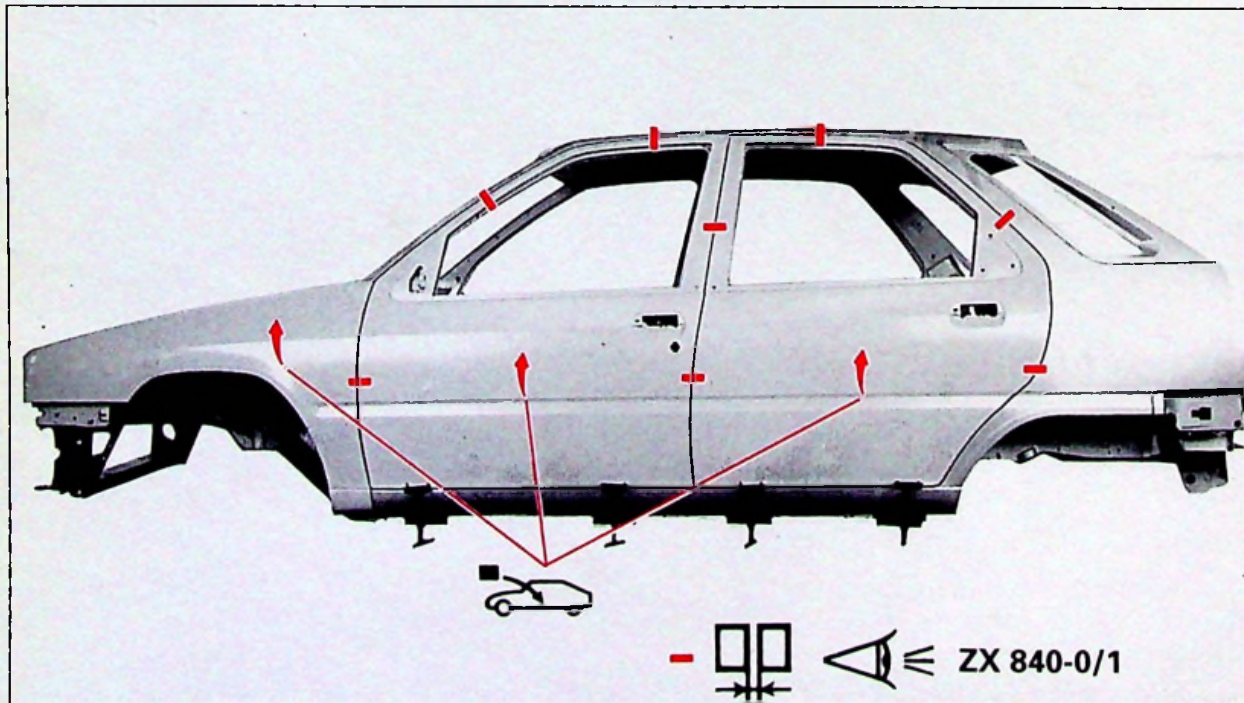

90-1804



14



ZX
821-3/2

3

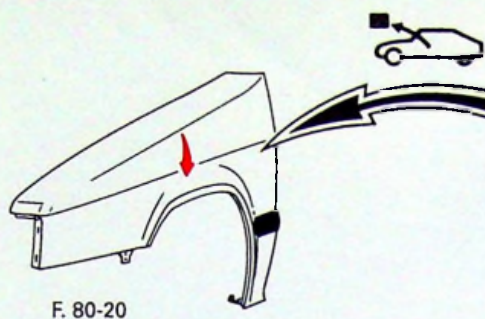

F. 80-20

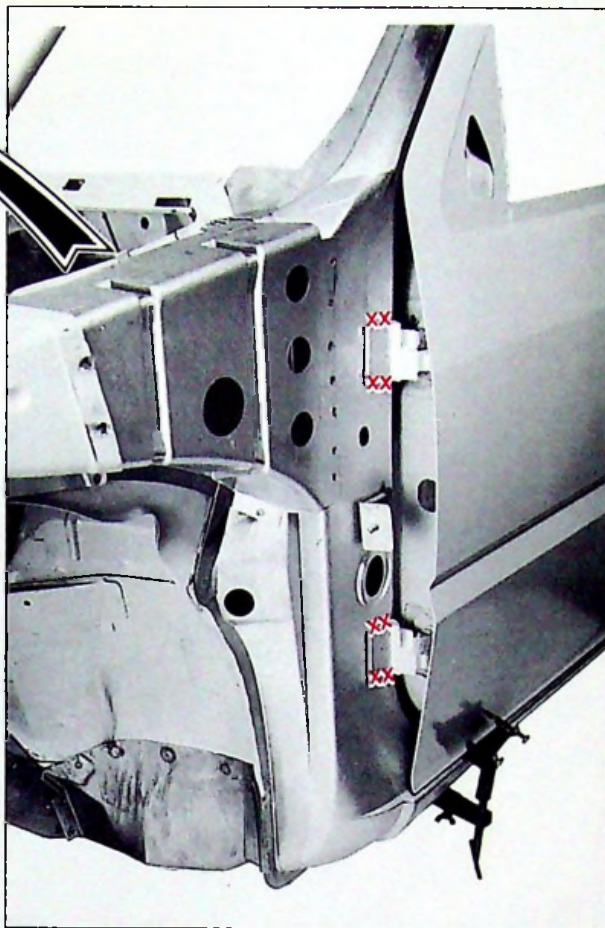

90-1806

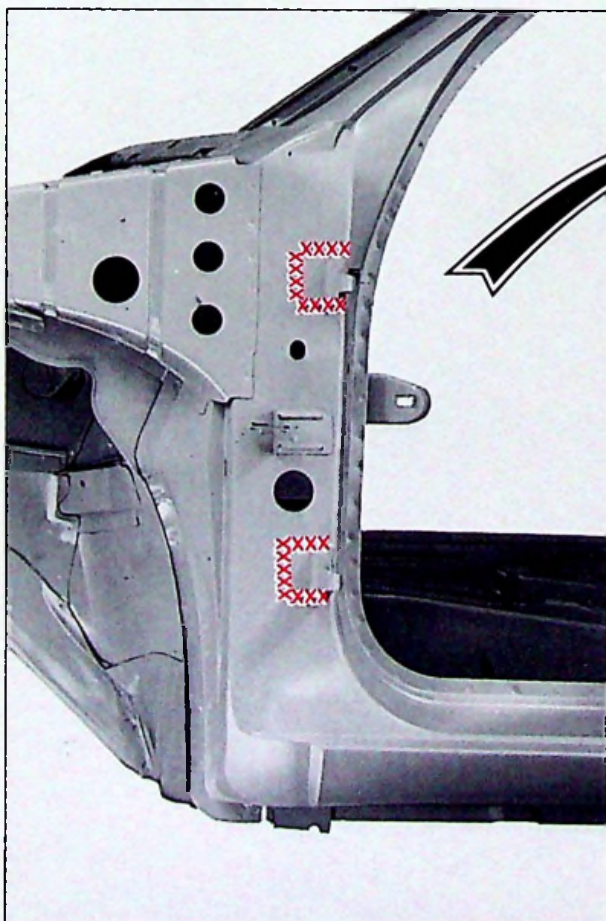

90-1085

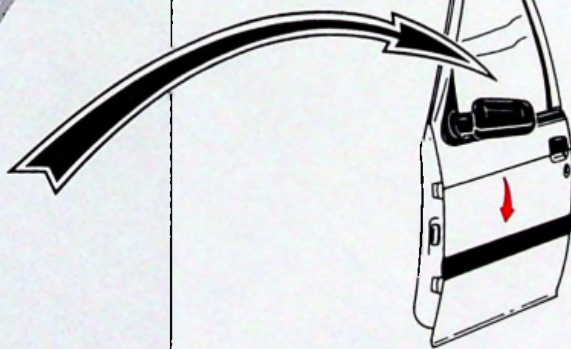
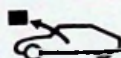

F. 80-20



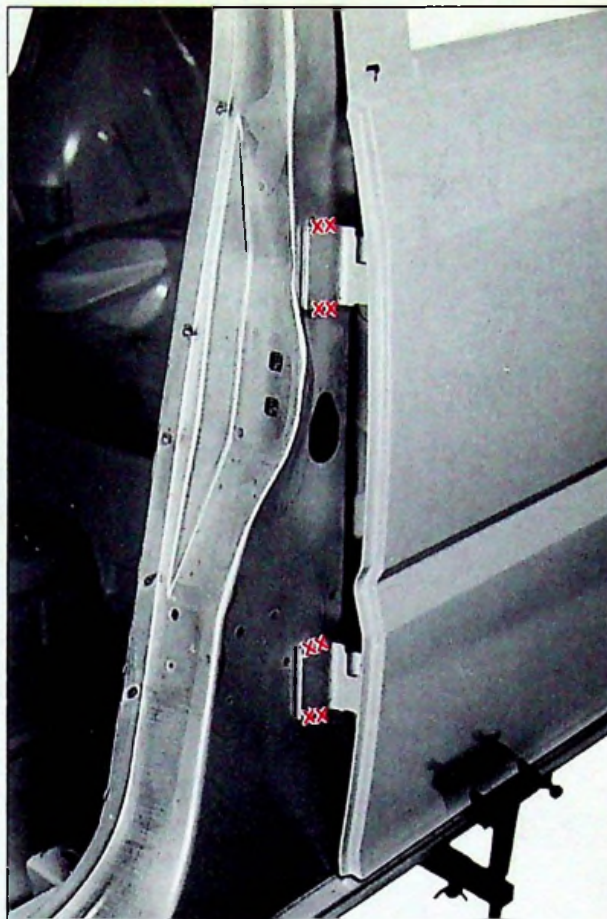

90-1805

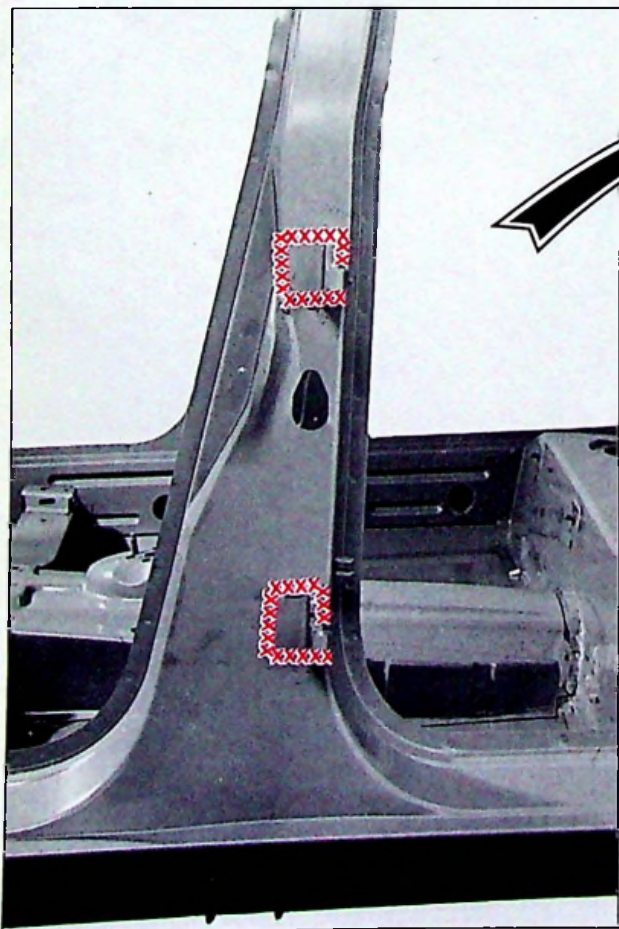

90-1082

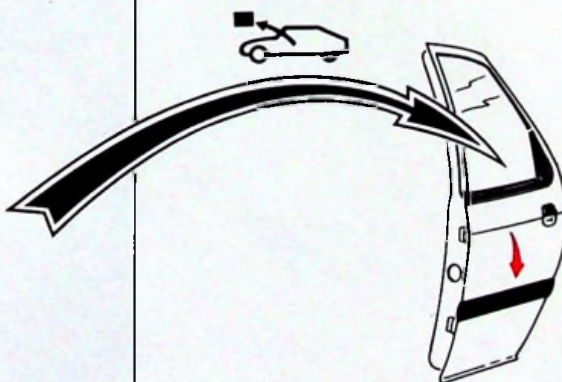

F. 80-20





14



ZX
821-3/2

5



90-1083

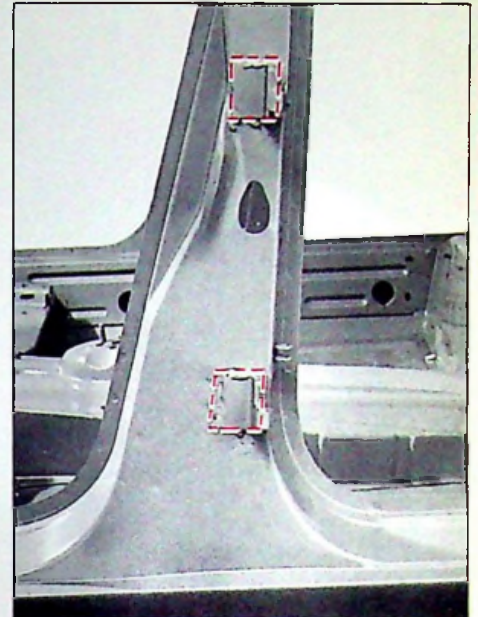

90-1082

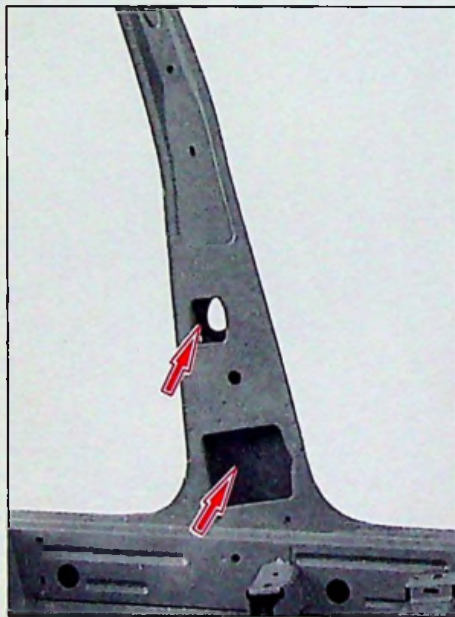

90-1096

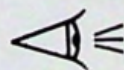

ZX 800-00/3
ZX 000-00/5

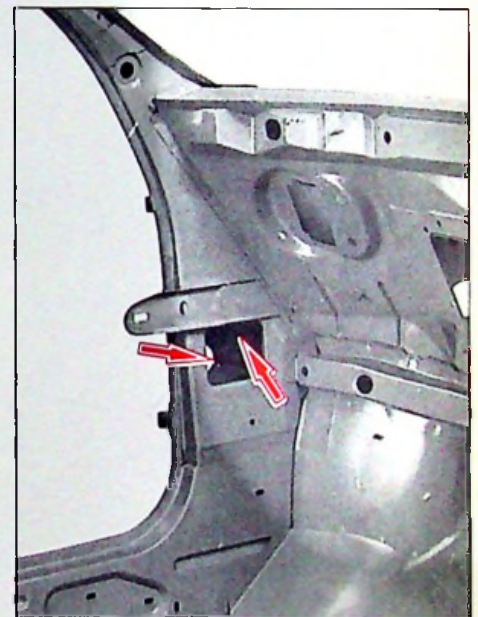

90-1076



90-1403



14



ZX
821-3/3

1

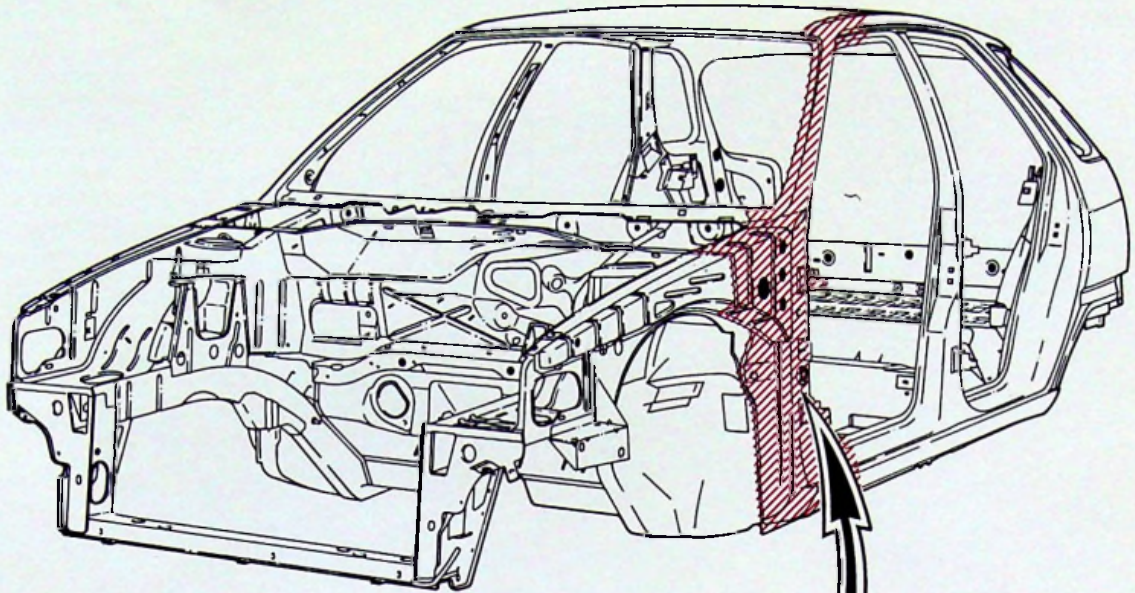

F.80-10

90-1138

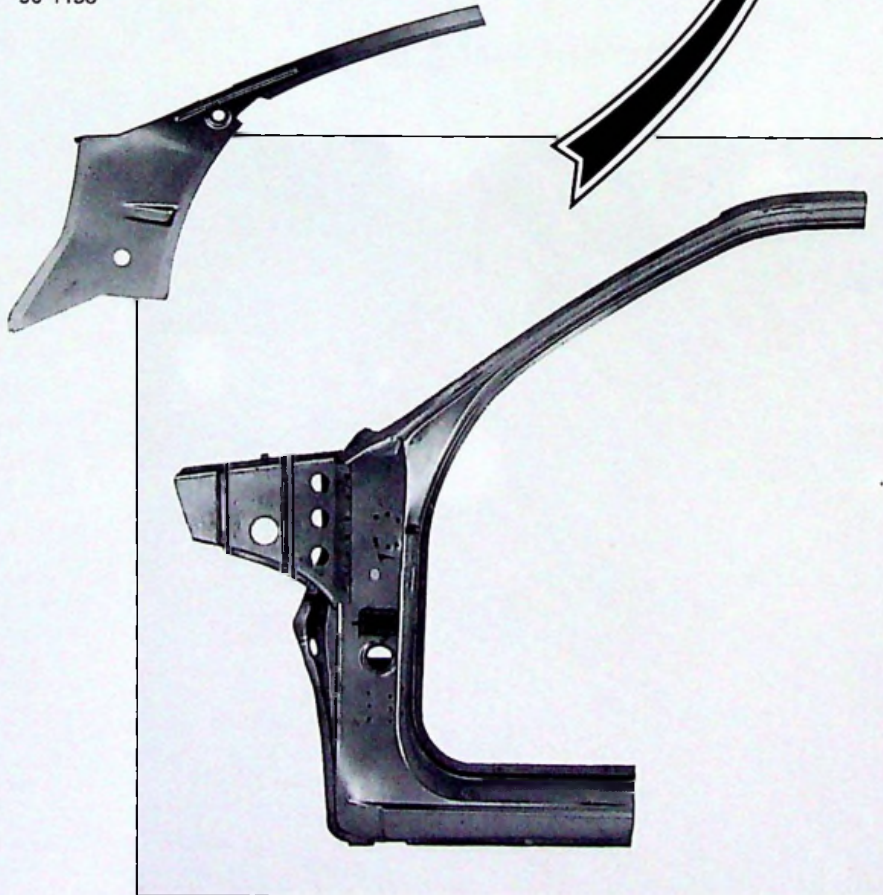

90-1165

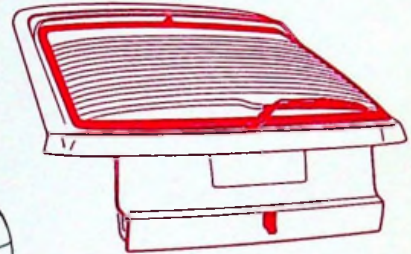
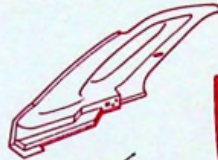
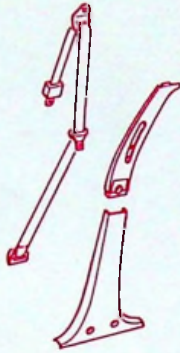
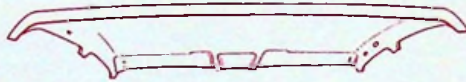



14



ZX
821-3/3

3

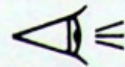
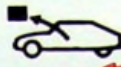

825-3/1



90-1084

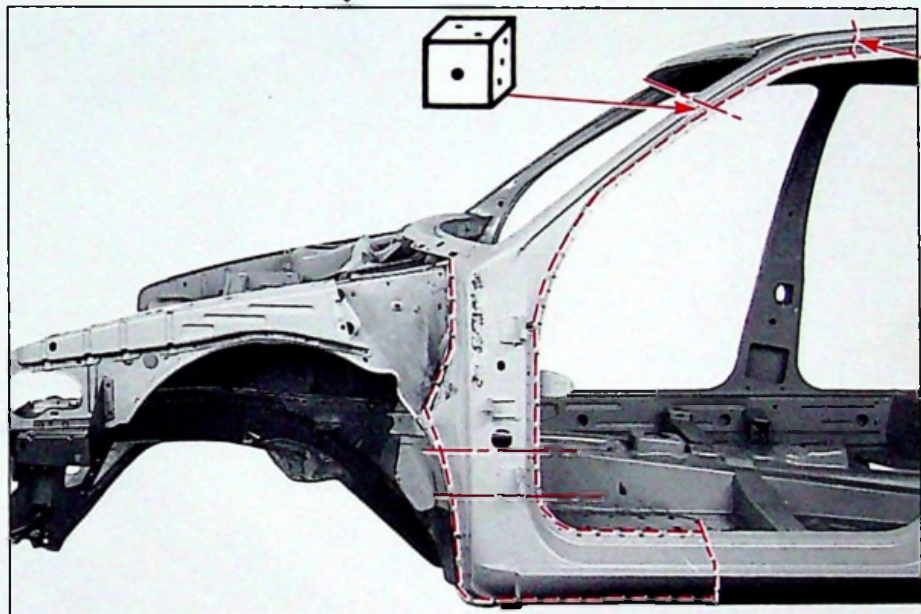
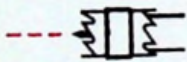
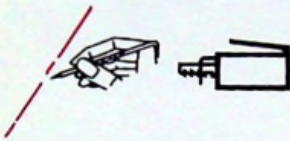

90-1666

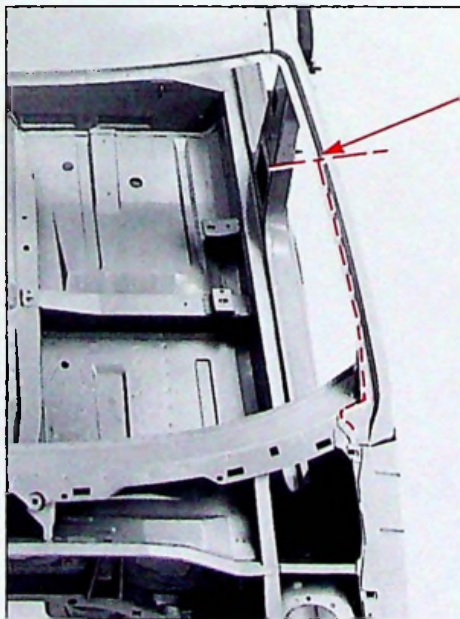

90-1069



90-1242

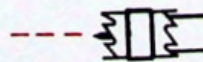

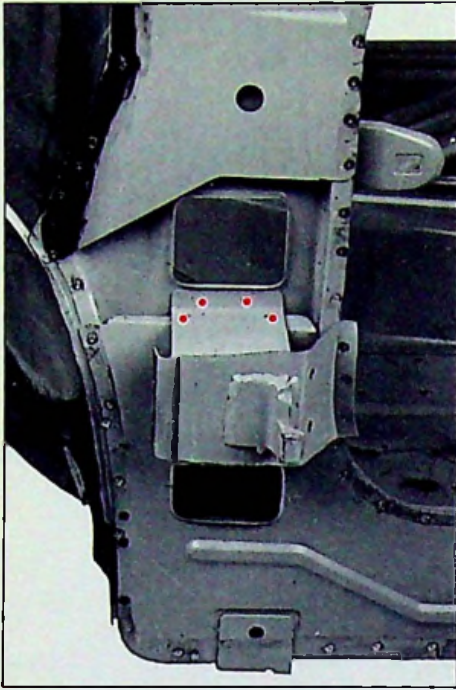

90-1678

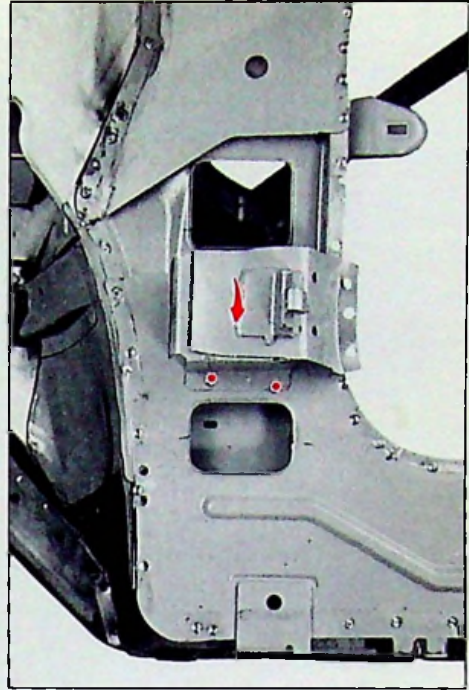
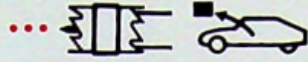

90-1679

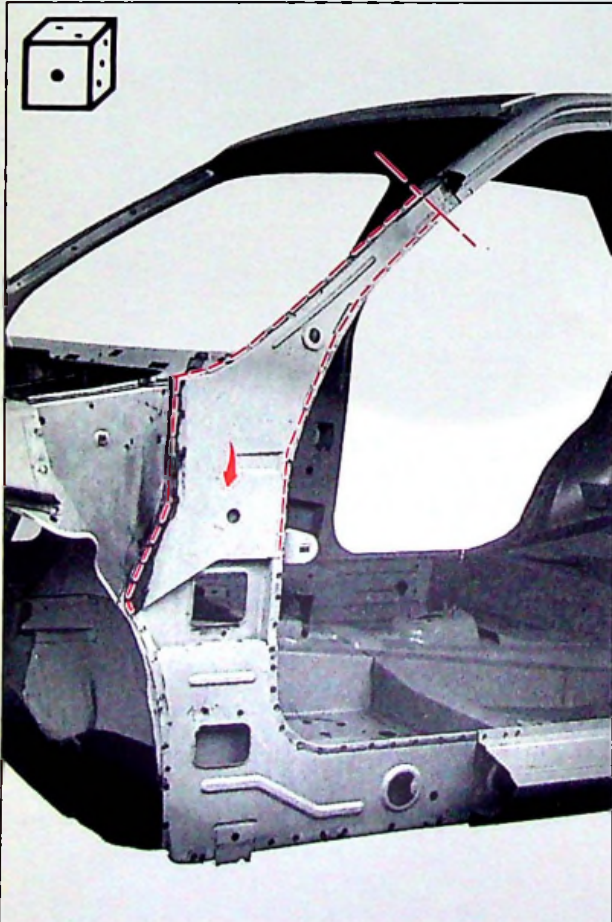
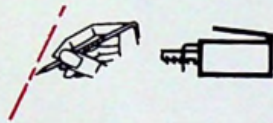

90-1680

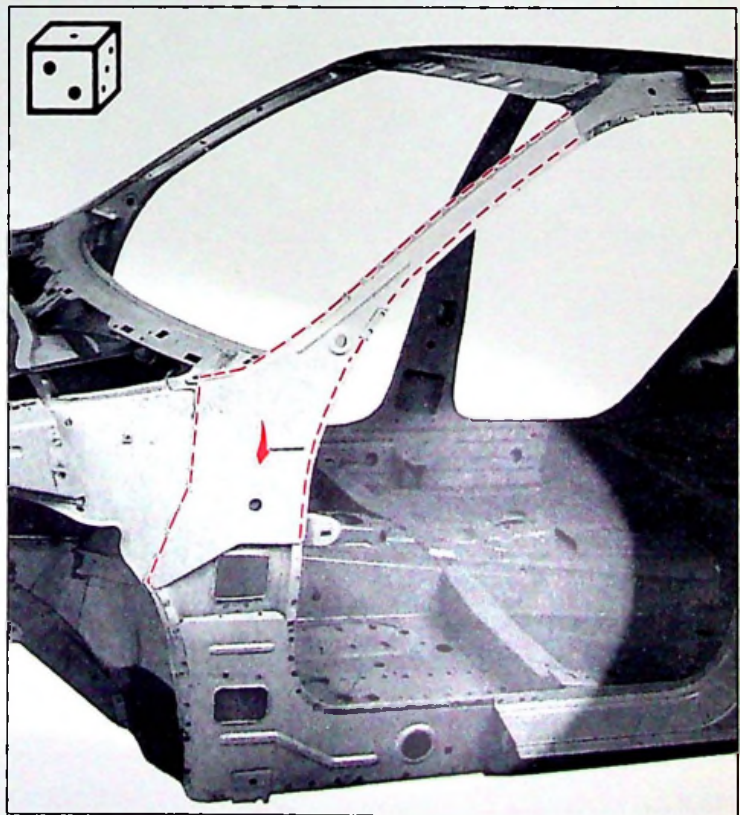

90-1696



14



ZX
821-3/3

5

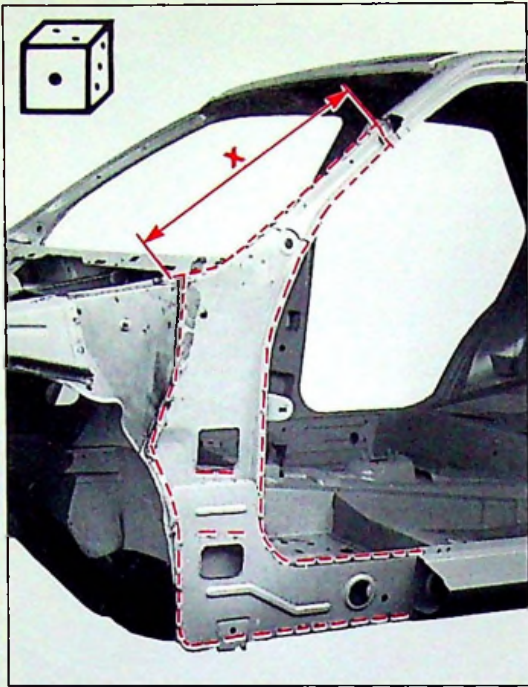

90-1681

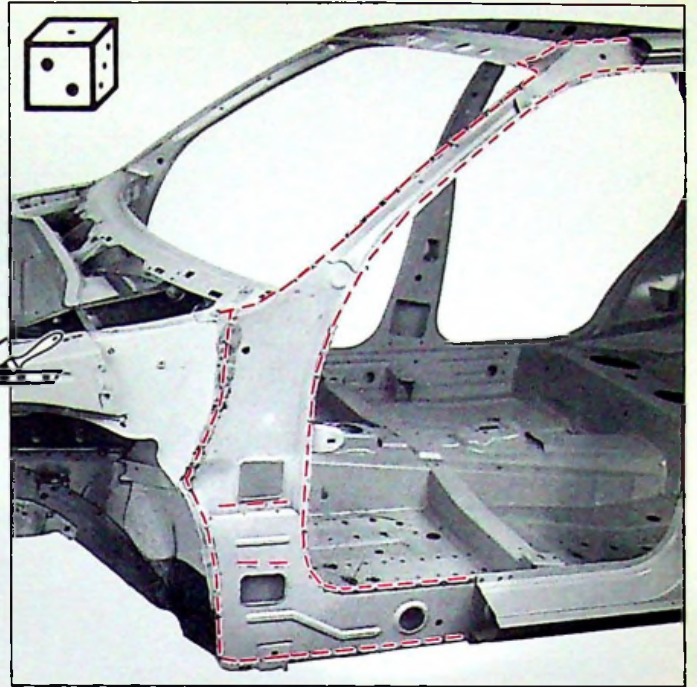

90-1697

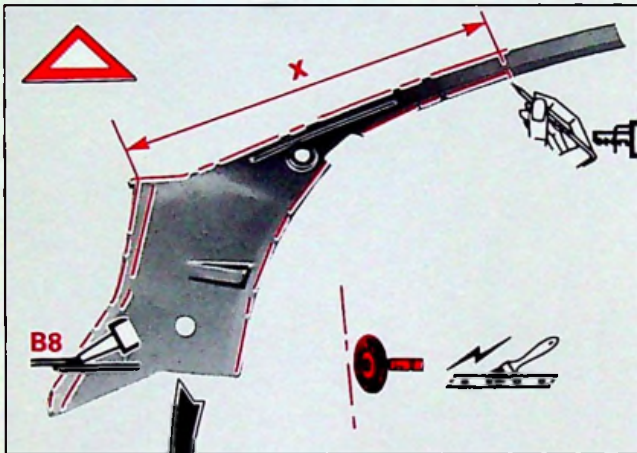

90-1138

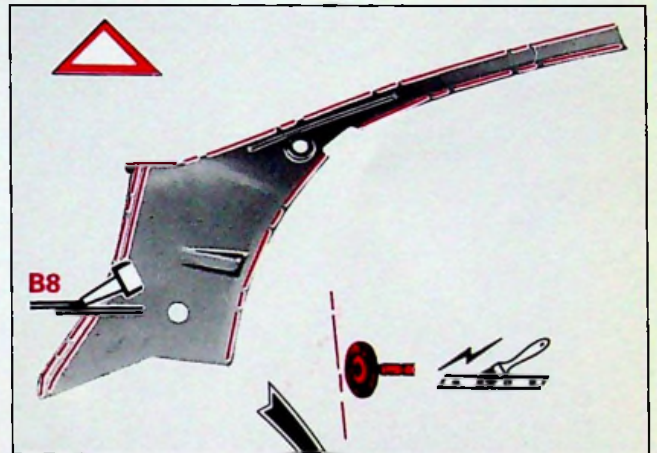

90-1138

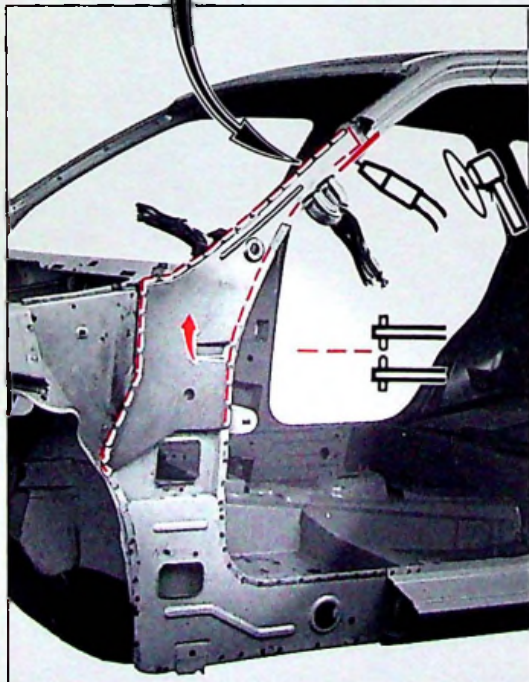

90-1682

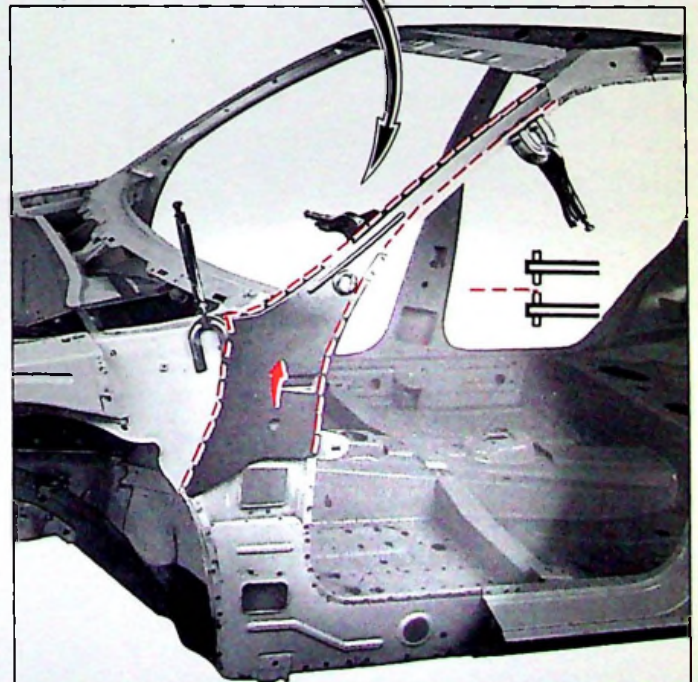

90-1698

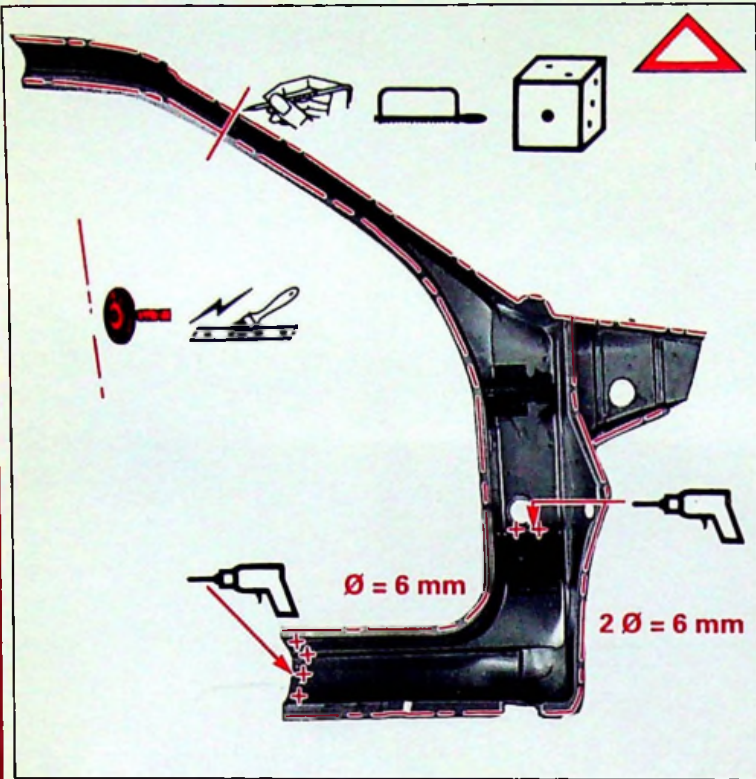

90-1166

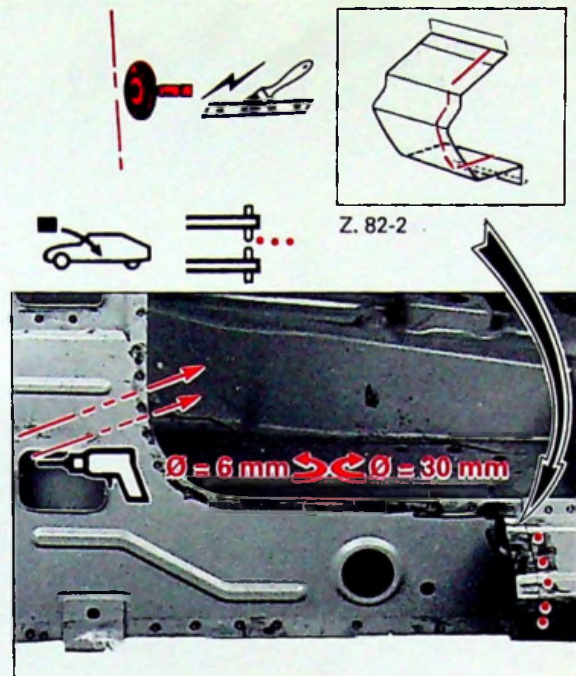

90-1699

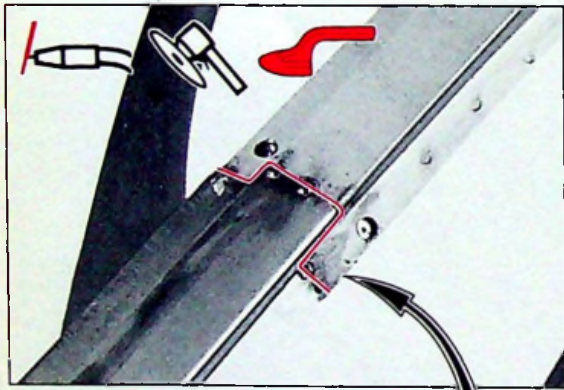

90-1685

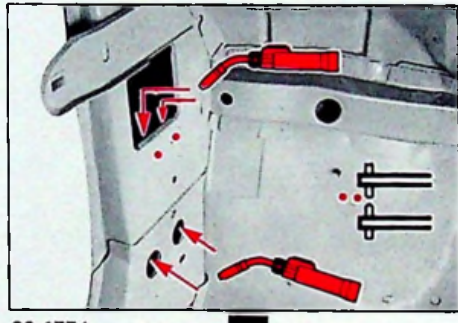

90-1774

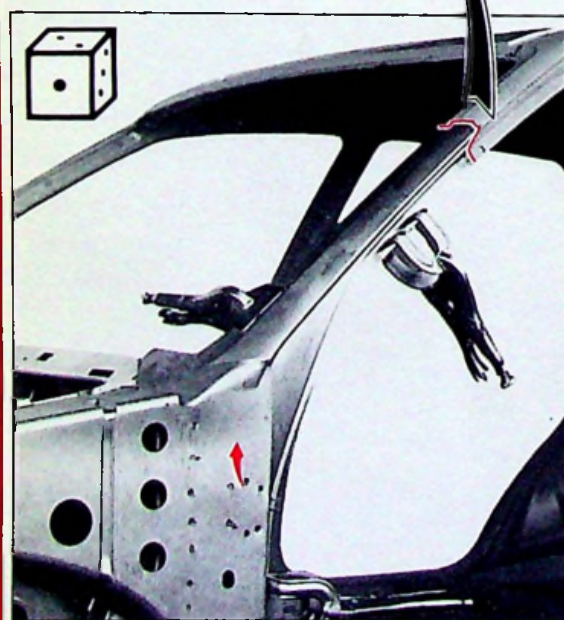

90-1684

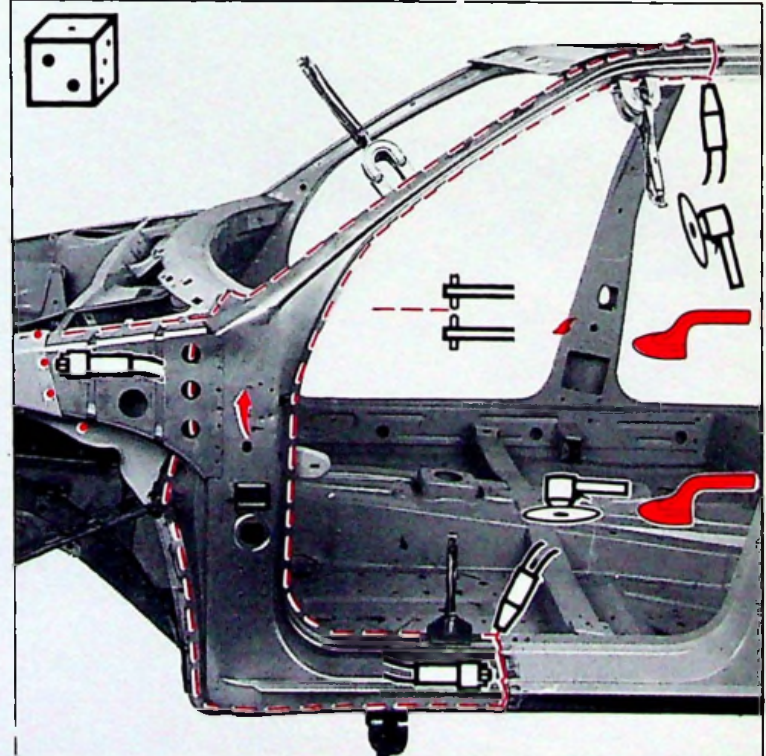

90-1700



14



ZX
821-3/3

7



90-1084

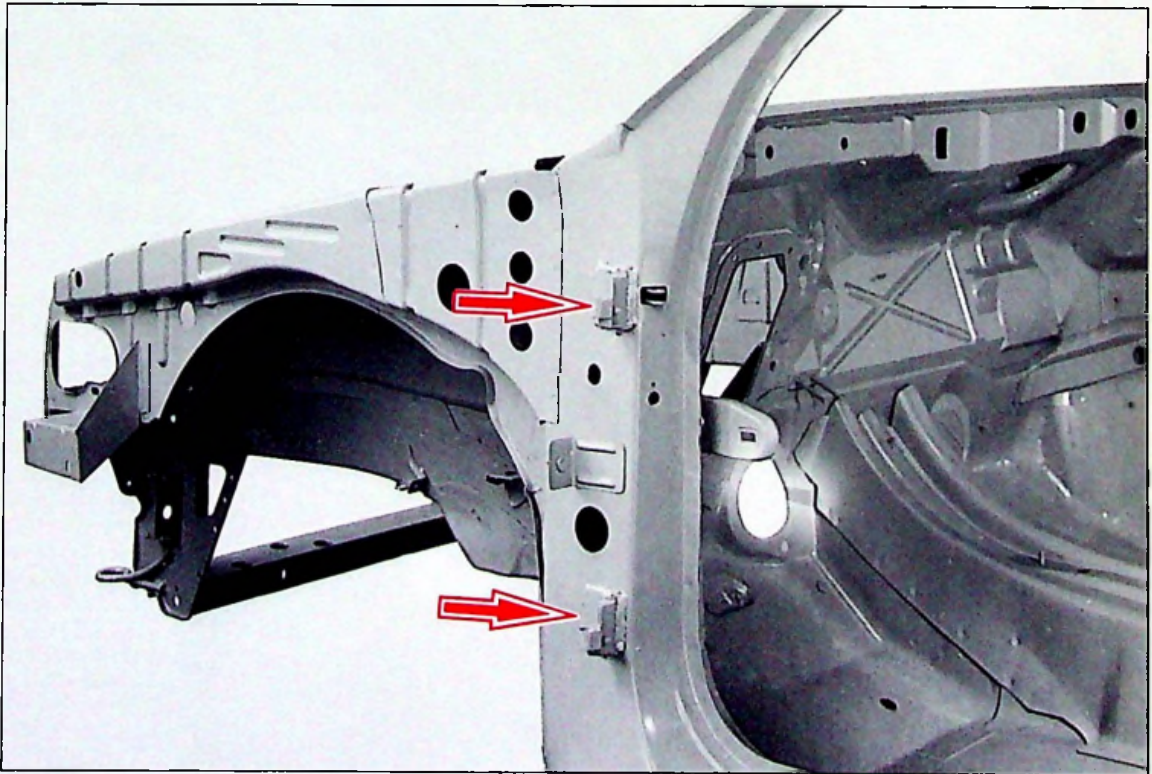

90-1083

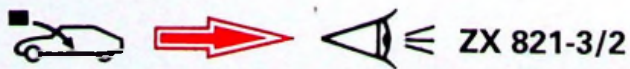

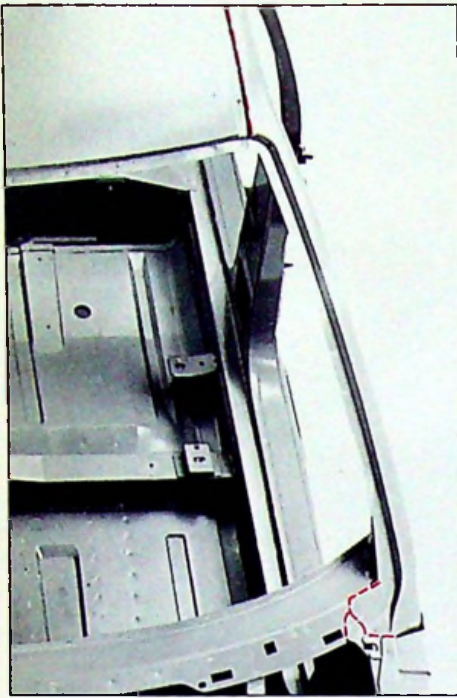

90-1069

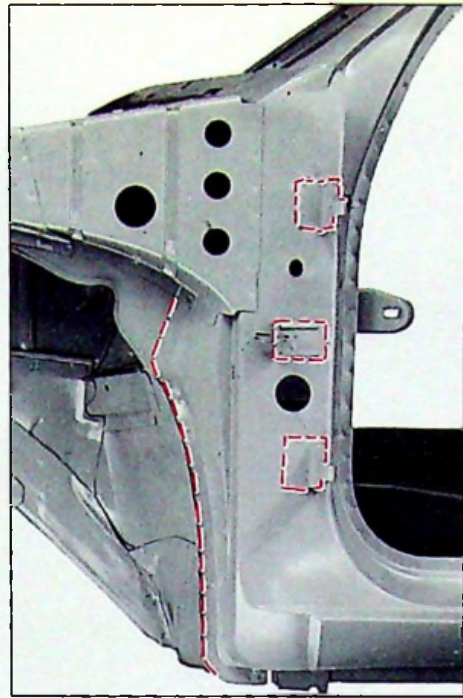

90-1085



90-1084



90-1079



ZX 000-00/5
ZX 800-00/3



90-1076



14



ZX
821-3/4

1

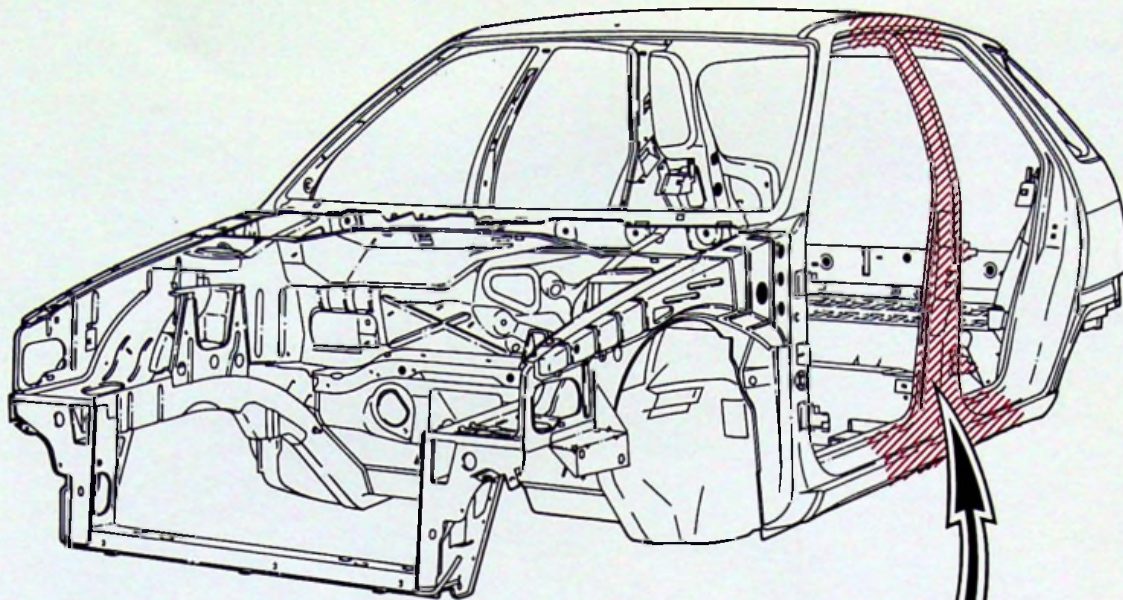

F.80-10

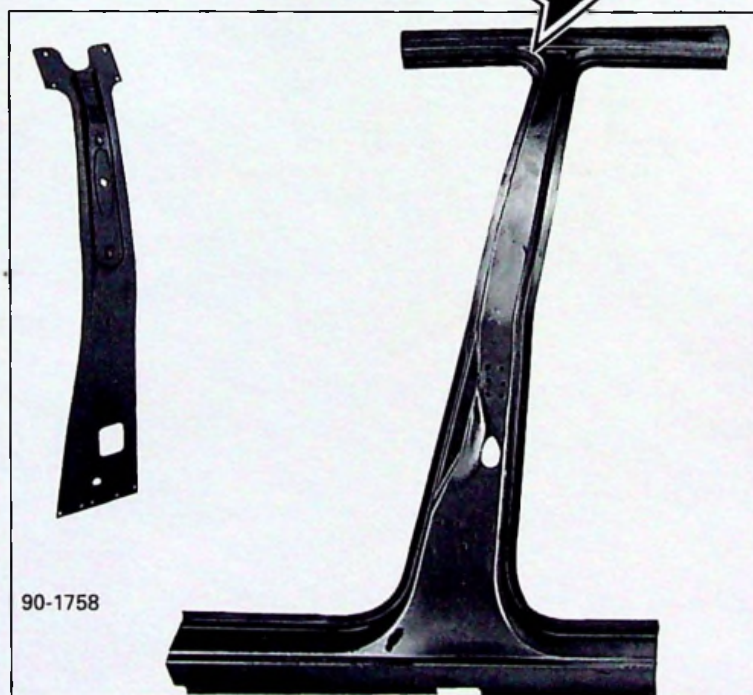

90-1758

90-1163

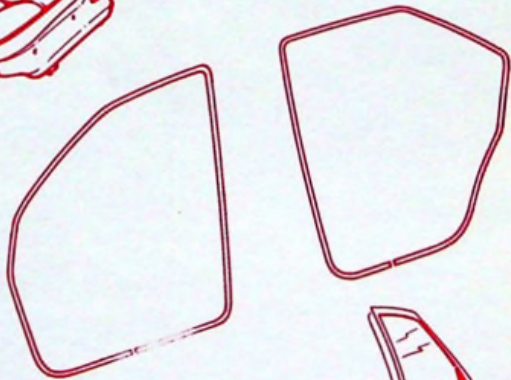
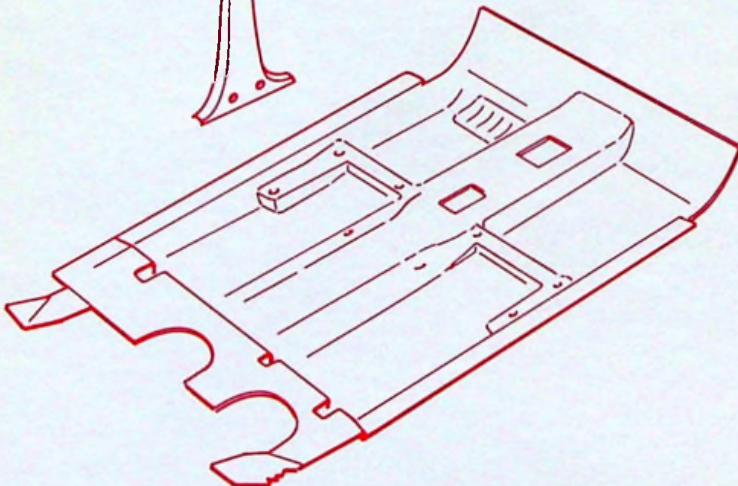
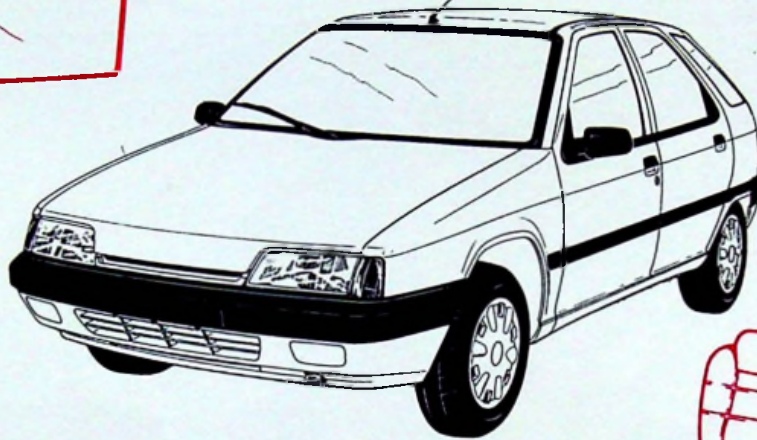
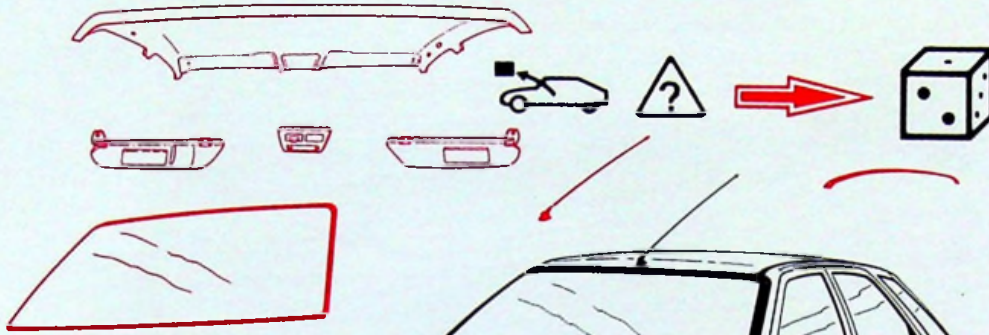



14



ZX
821-3/4

3

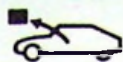

ZX 825-3/1

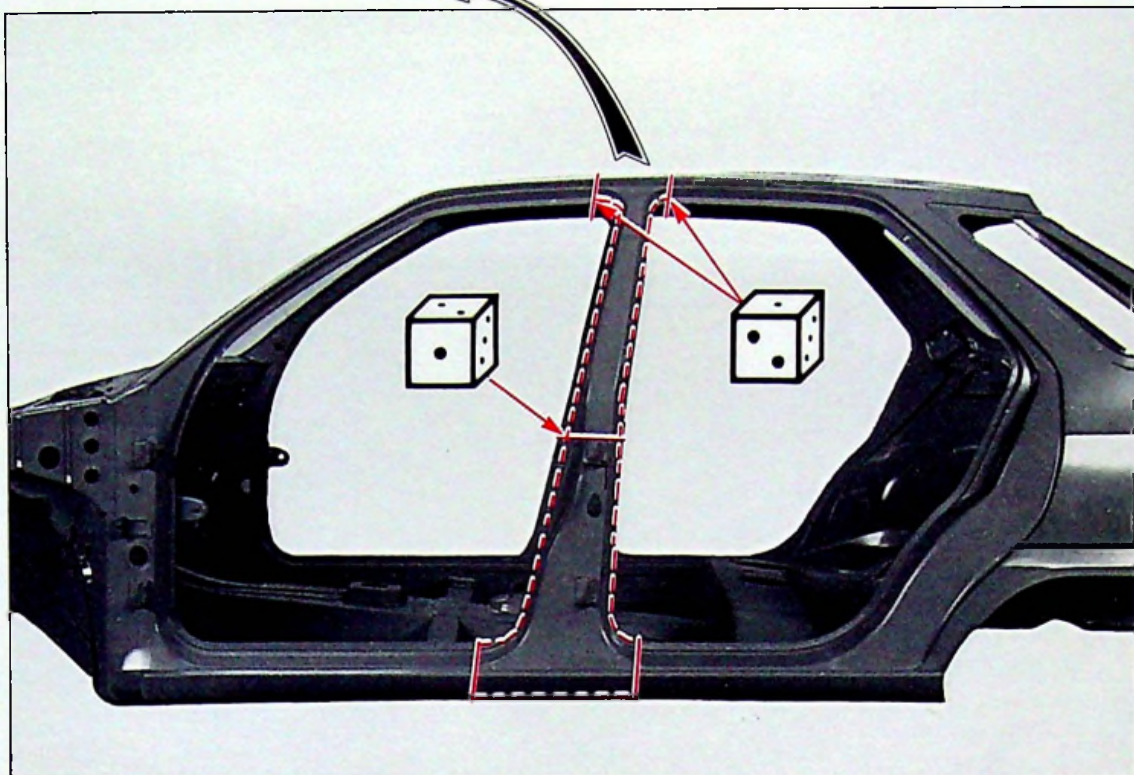

90-1084

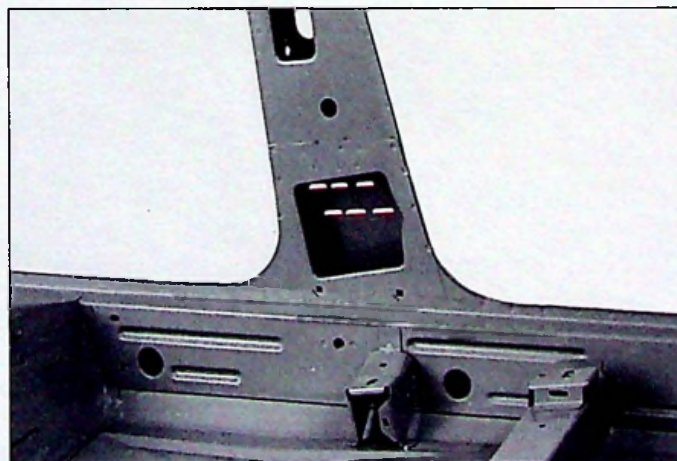

90-1095

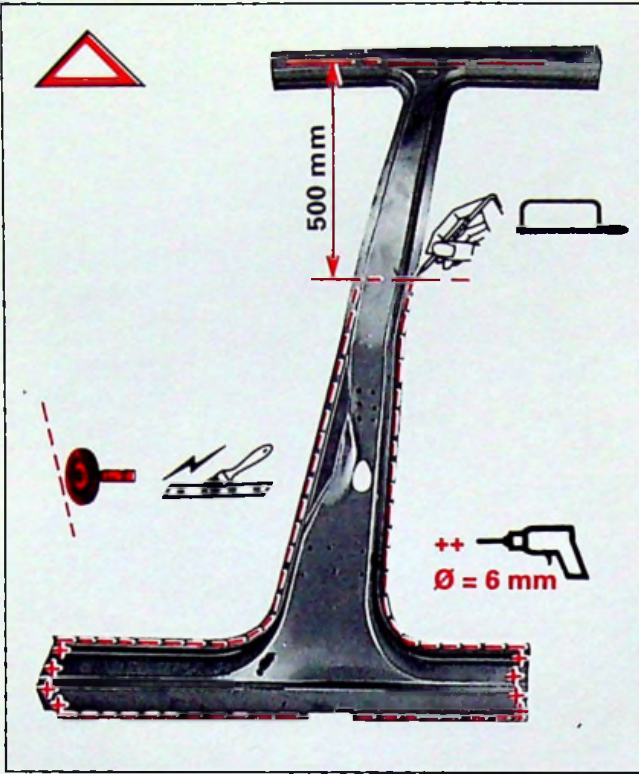

90-1163

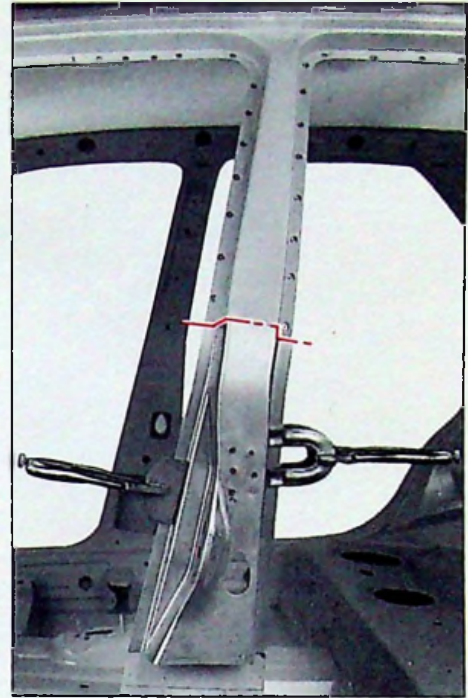

90-1701

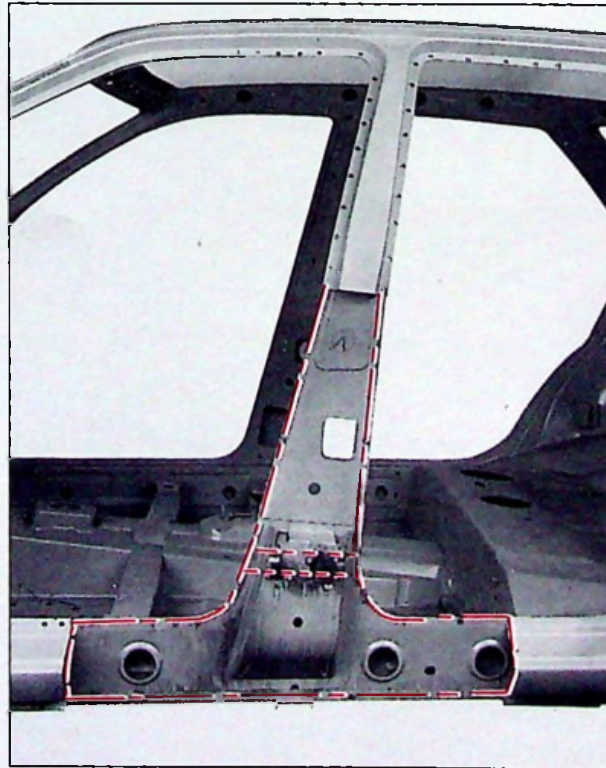

90-1702





14



ZX
821-3/4

5

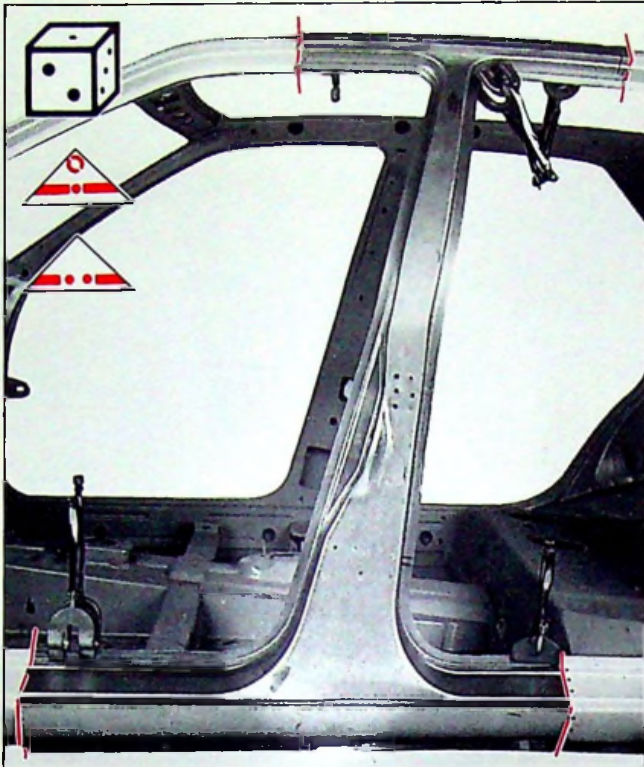

90-1759

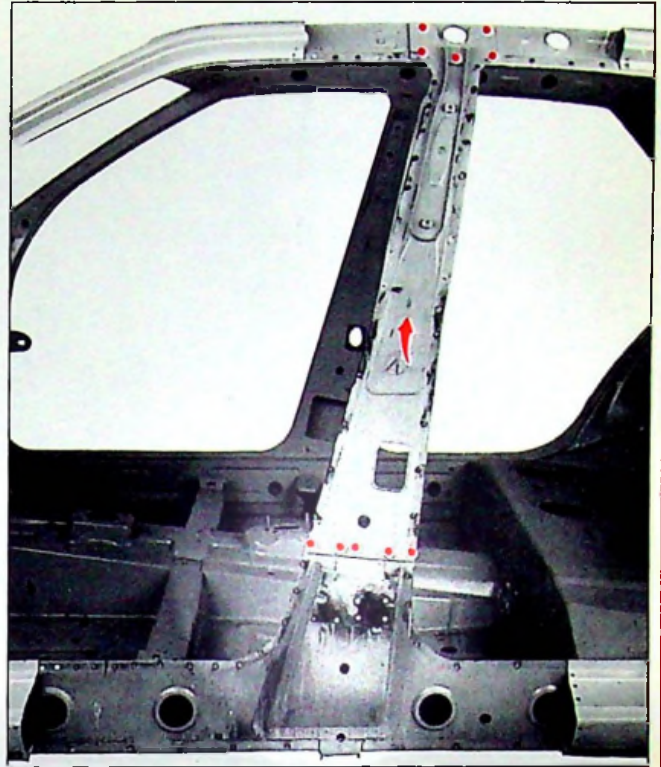

90-1760

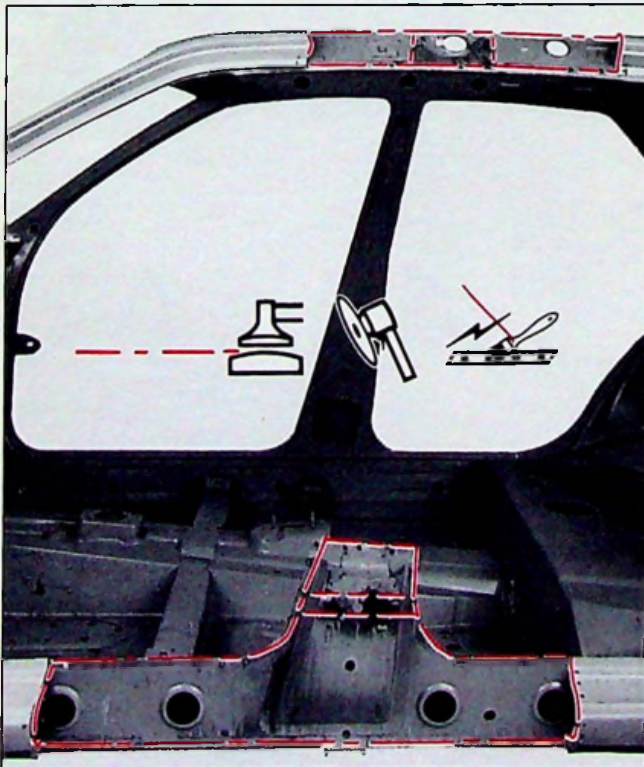
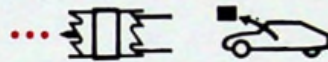
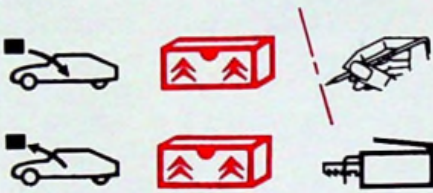

90-1761



90-1758

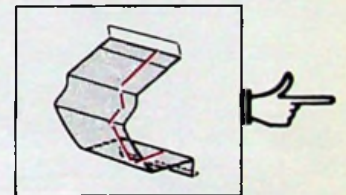

Z. 82-2

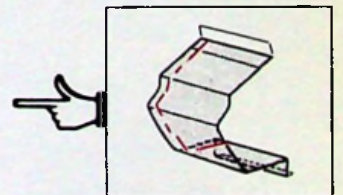

Z. 82-2

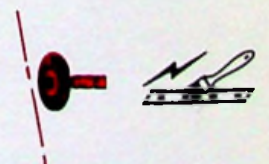

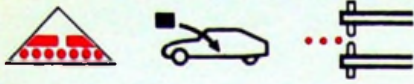

90-1762

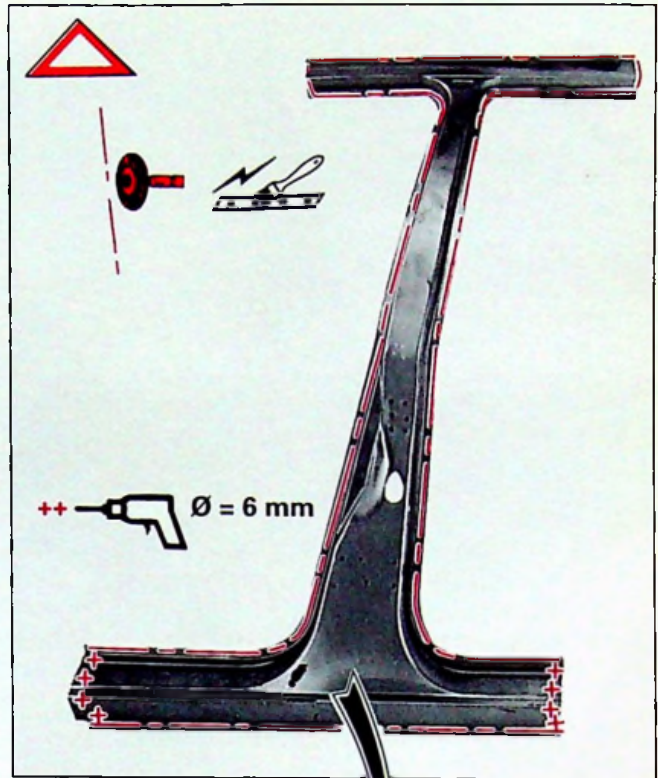

90-1163

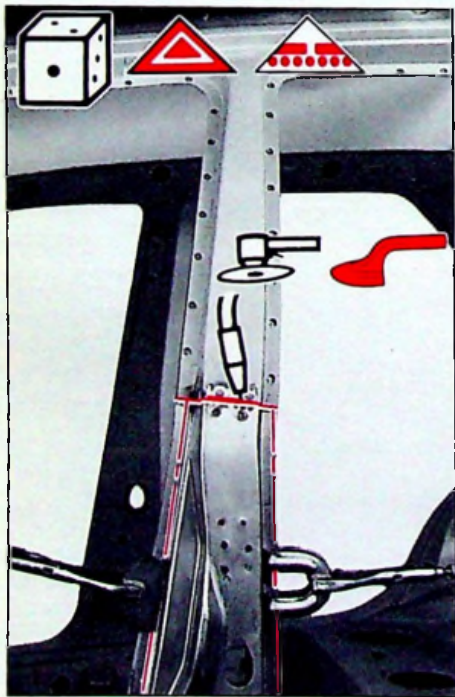

90-1704

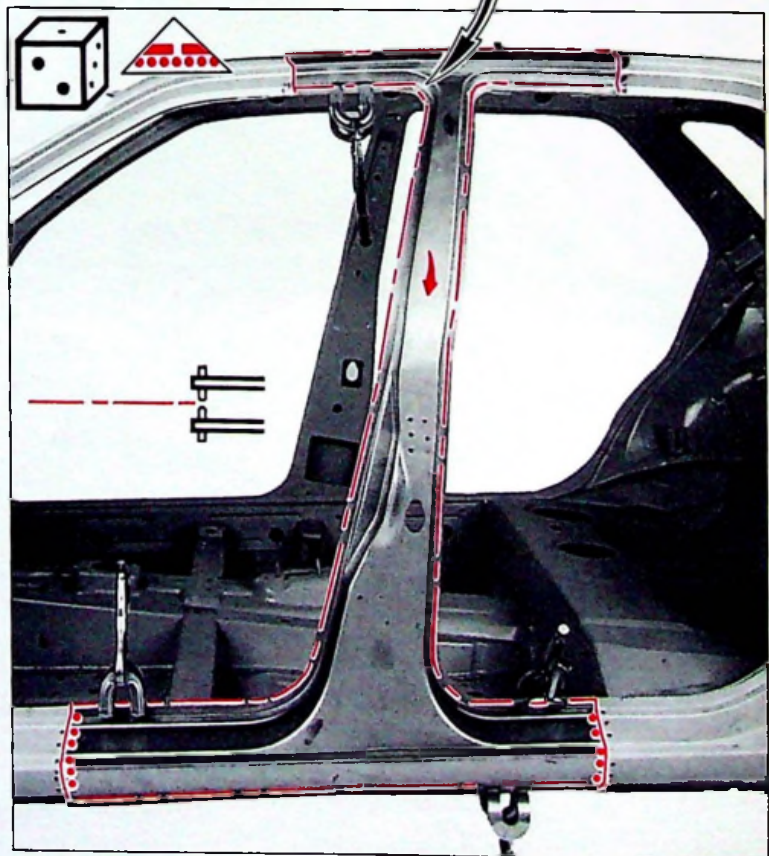

90-1763





14



ZX
821-3/4

7

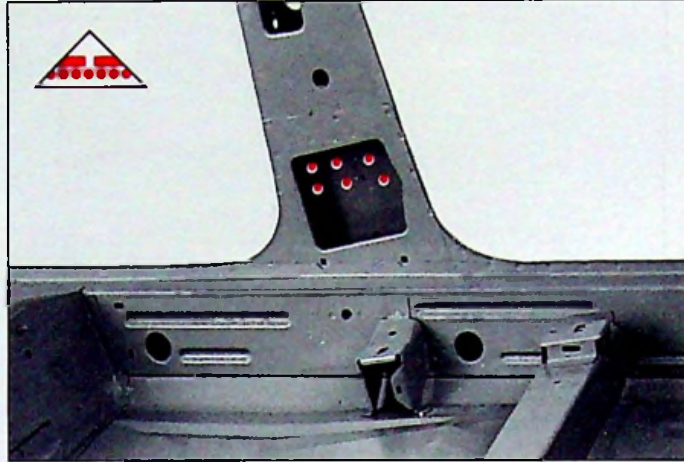

90-1095

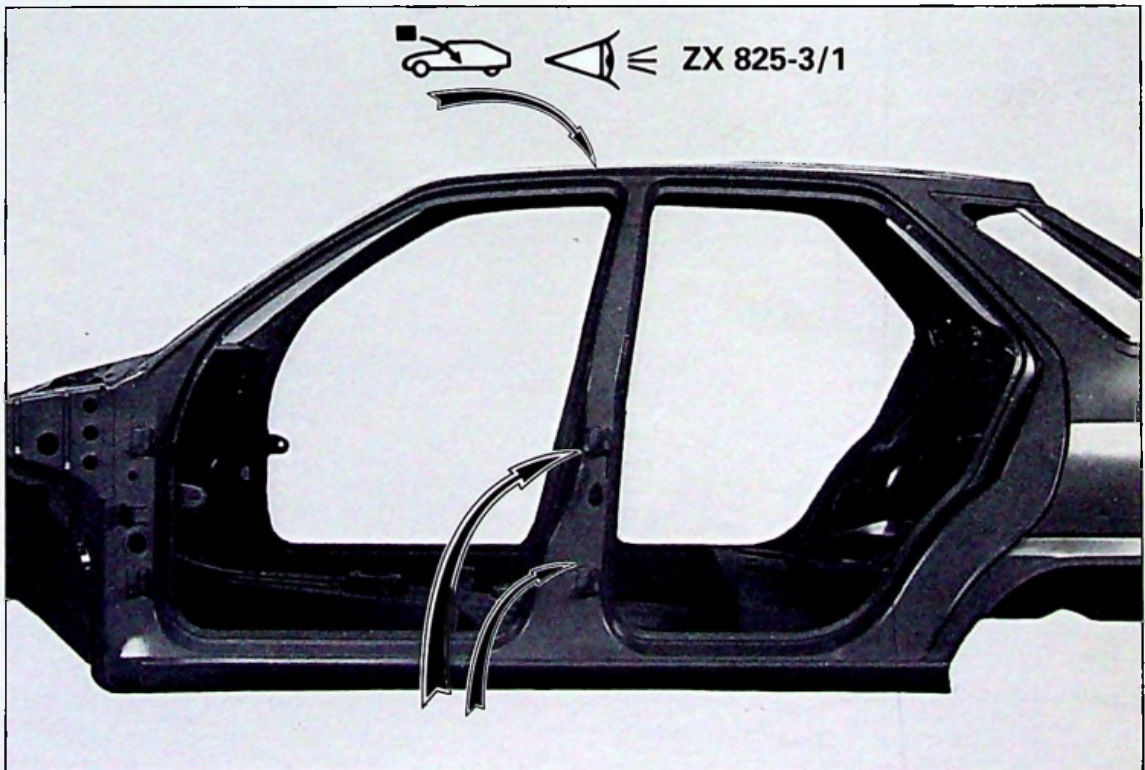

90-1084





90-1084

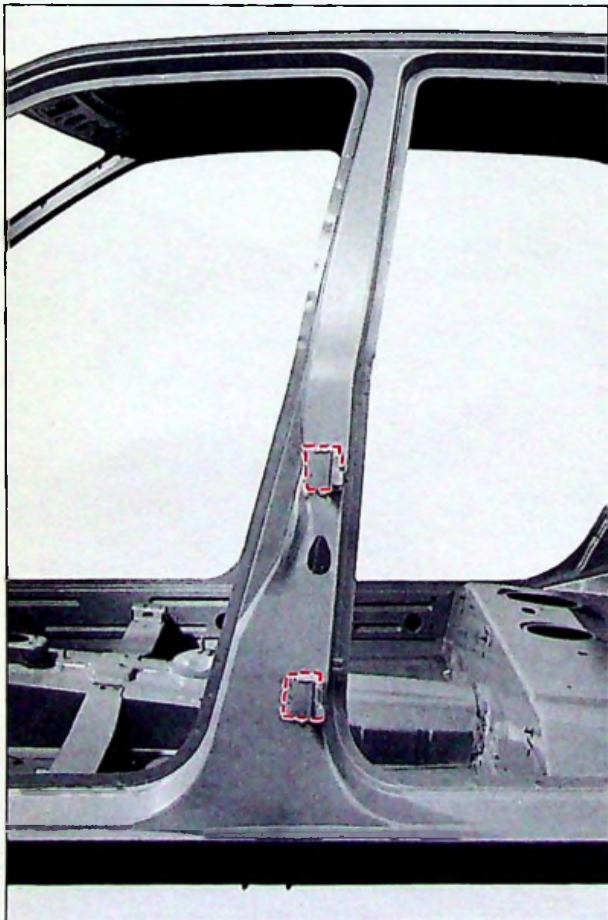
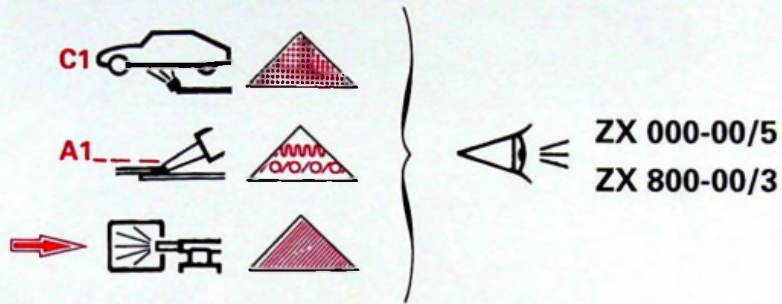

90-1082

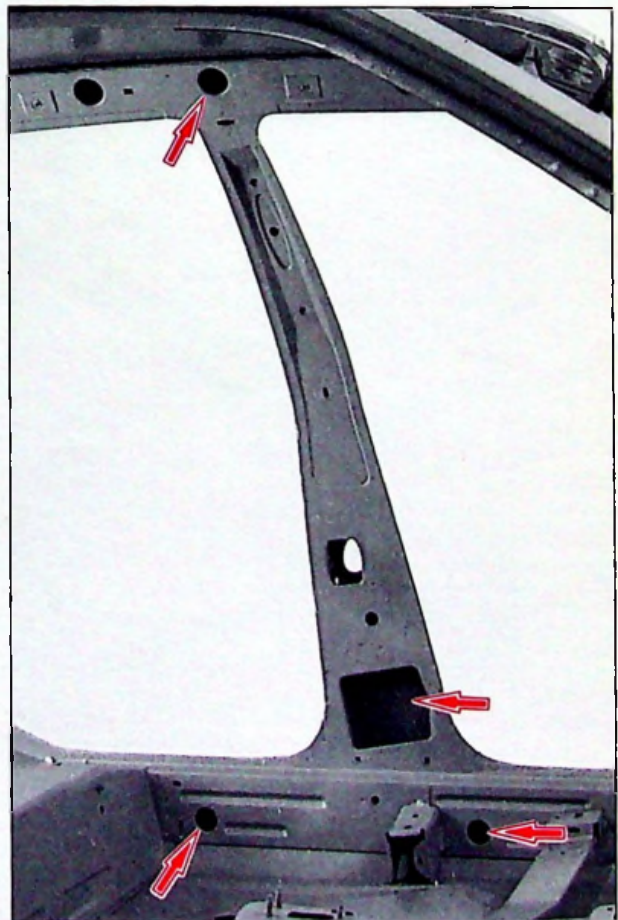

90-1096



14



ZX
821-3/5

1

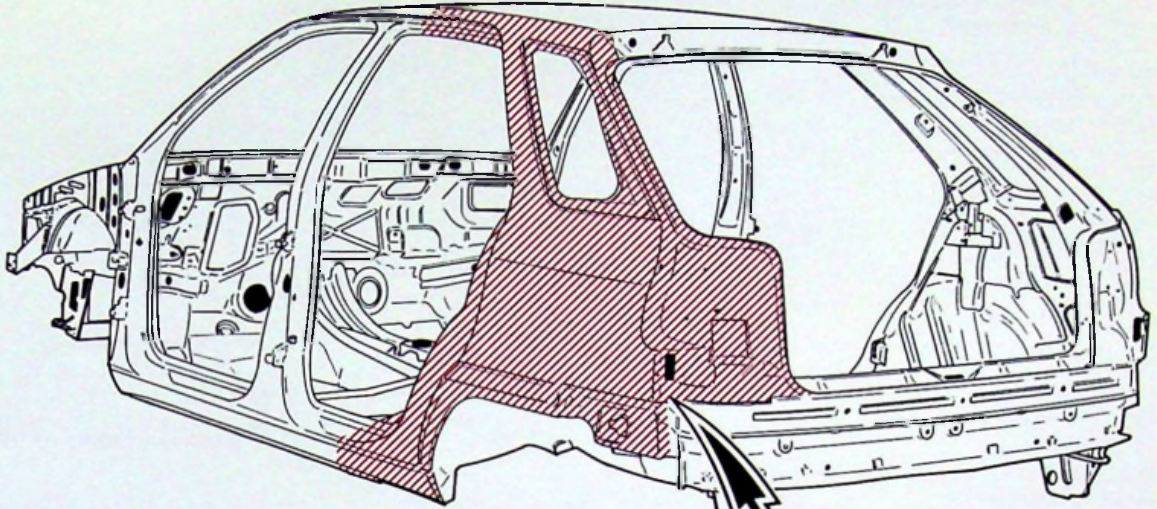

F.80-11

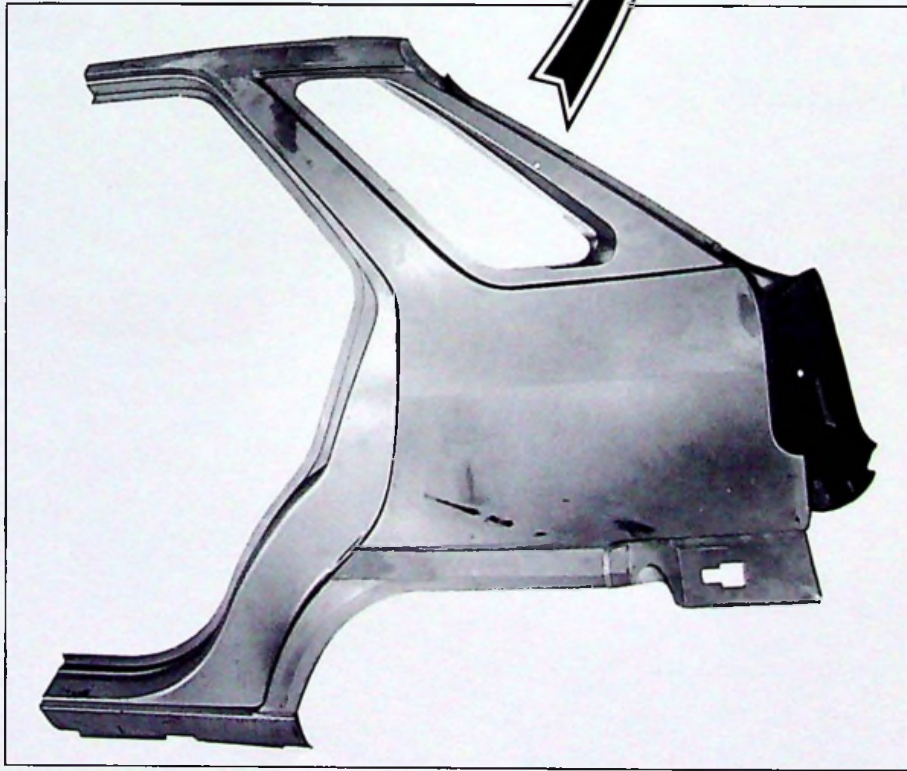

90-1162

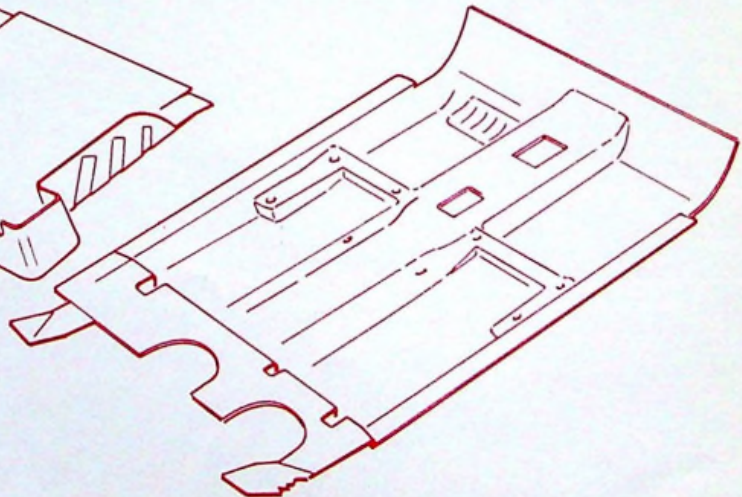
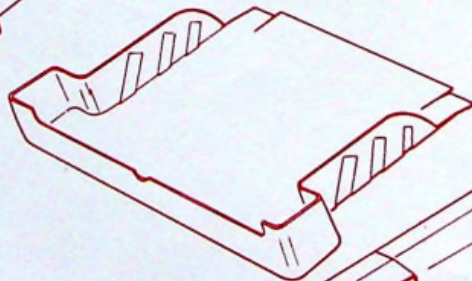
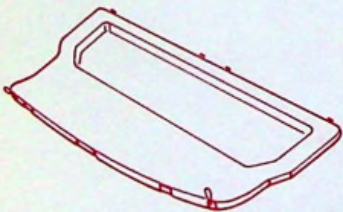
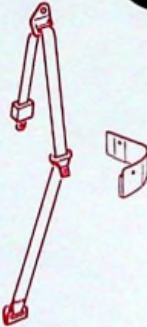
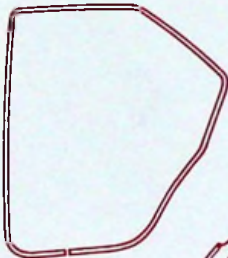
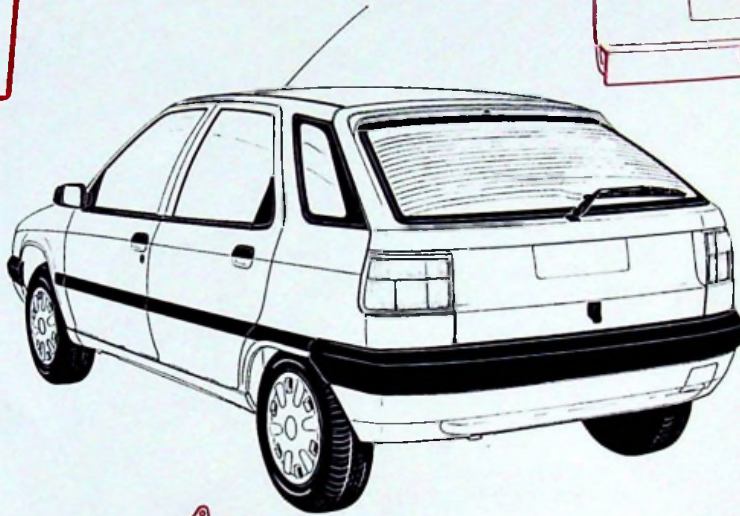
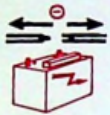
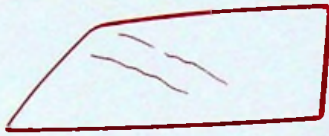
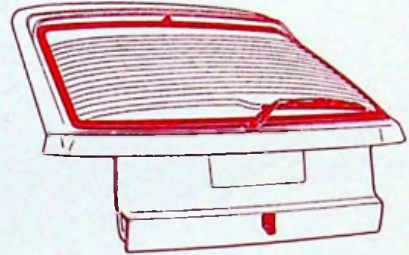
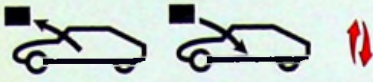

- F. 80-13
- F. 80-19
- F. 80-20
- F. 80-28



14



ZX
821-3/5

3

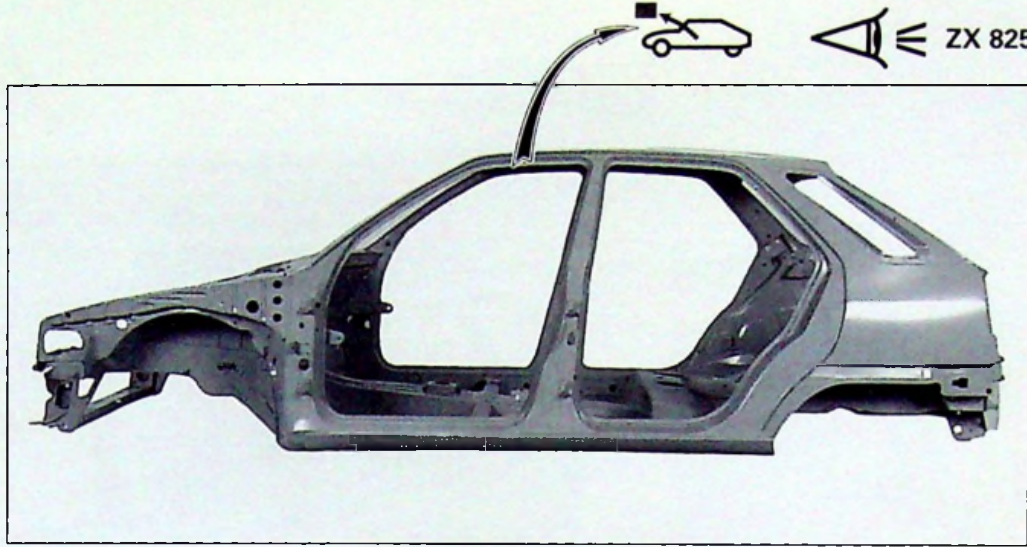

90-1084

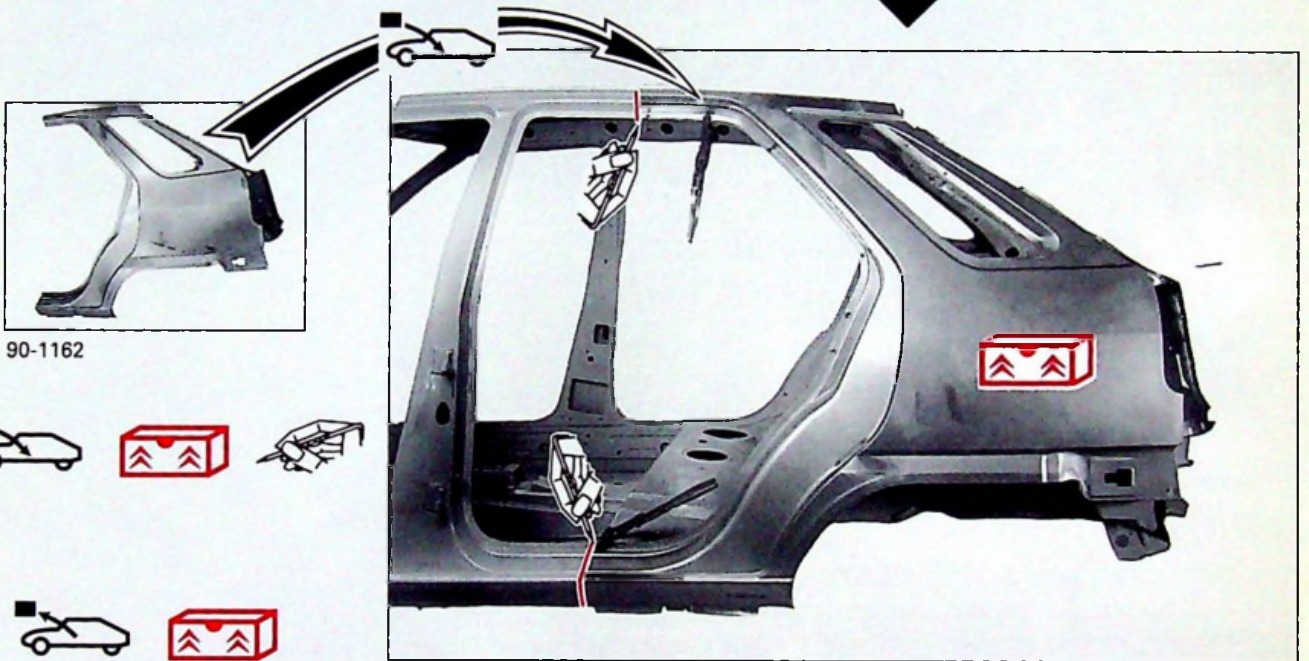

91-539

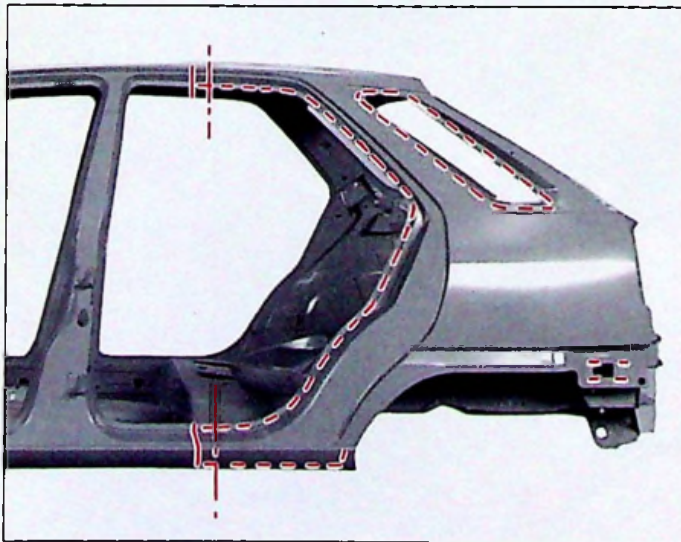

90-1084

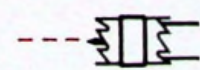
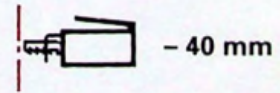

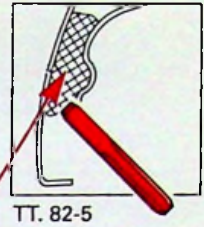
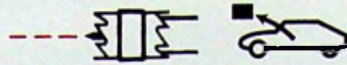
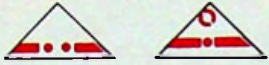

TT. 82-5

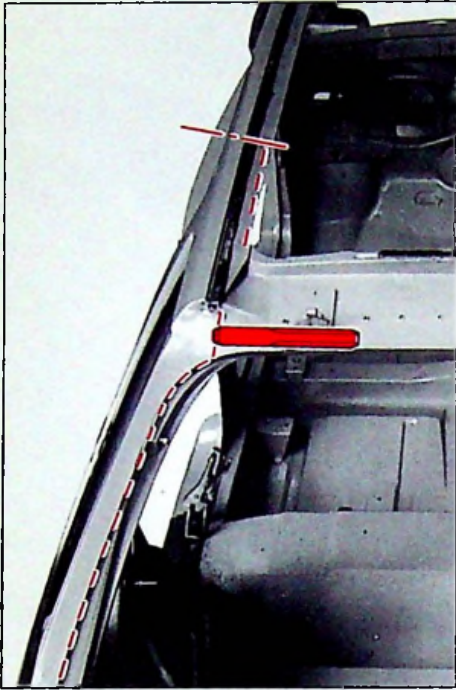

90-1241

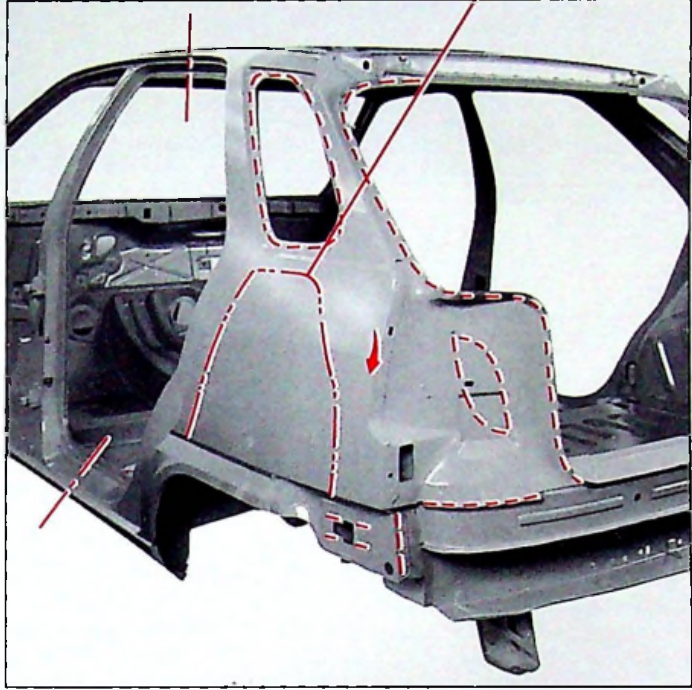

90-964

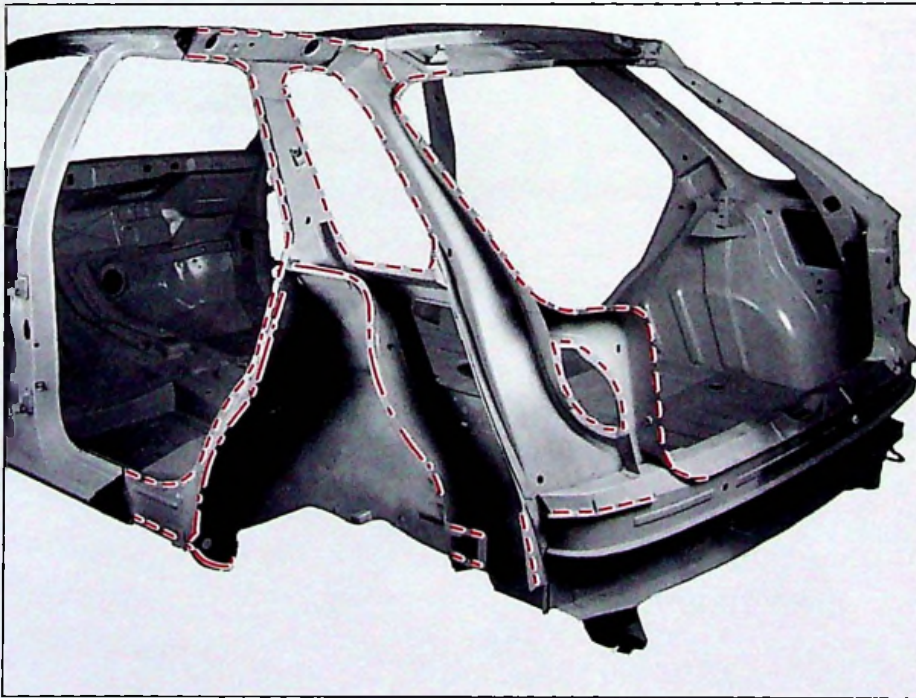

91-542

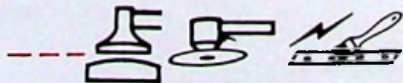



14



ZX
821-3/5

5

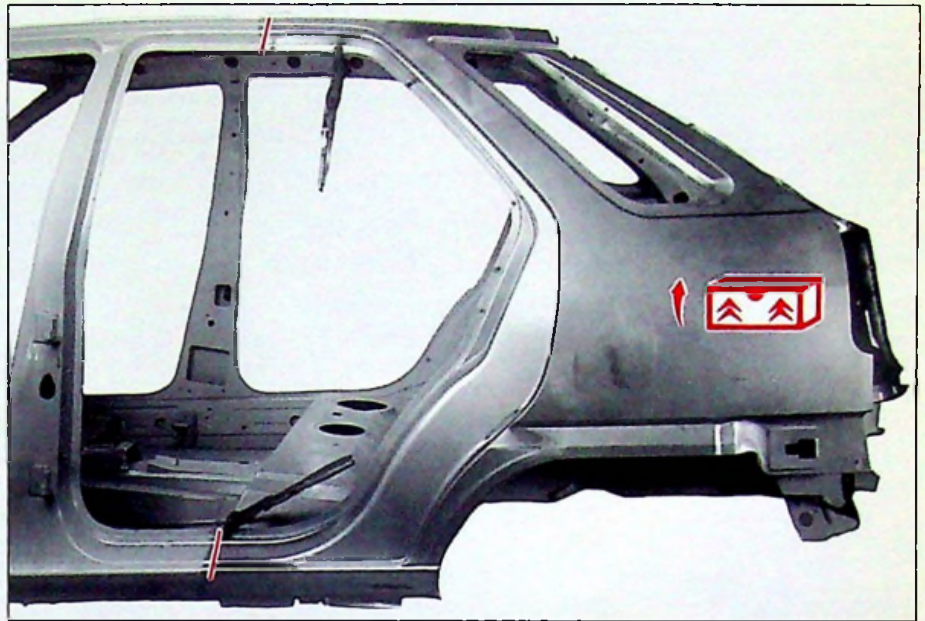
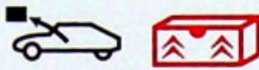
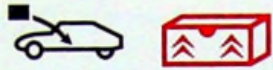

91-539



+++  Ø = 6 mm

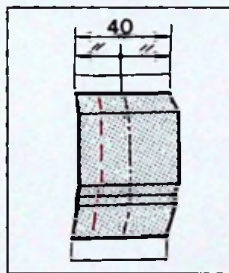
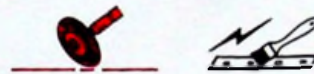

Z. 82-2

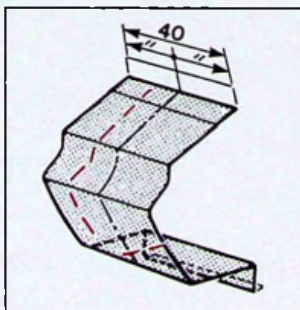

Z. 82-2

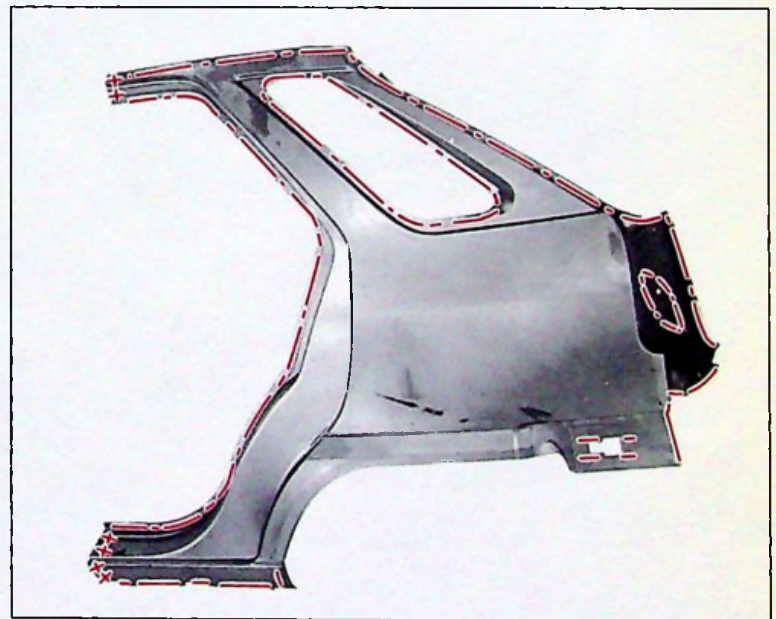

90-1162

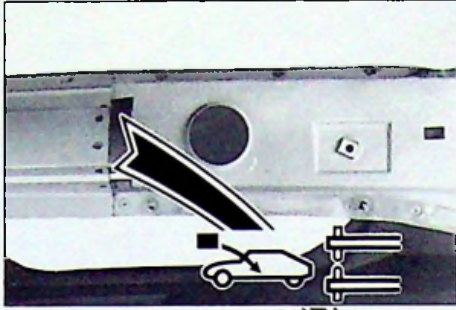

91-541

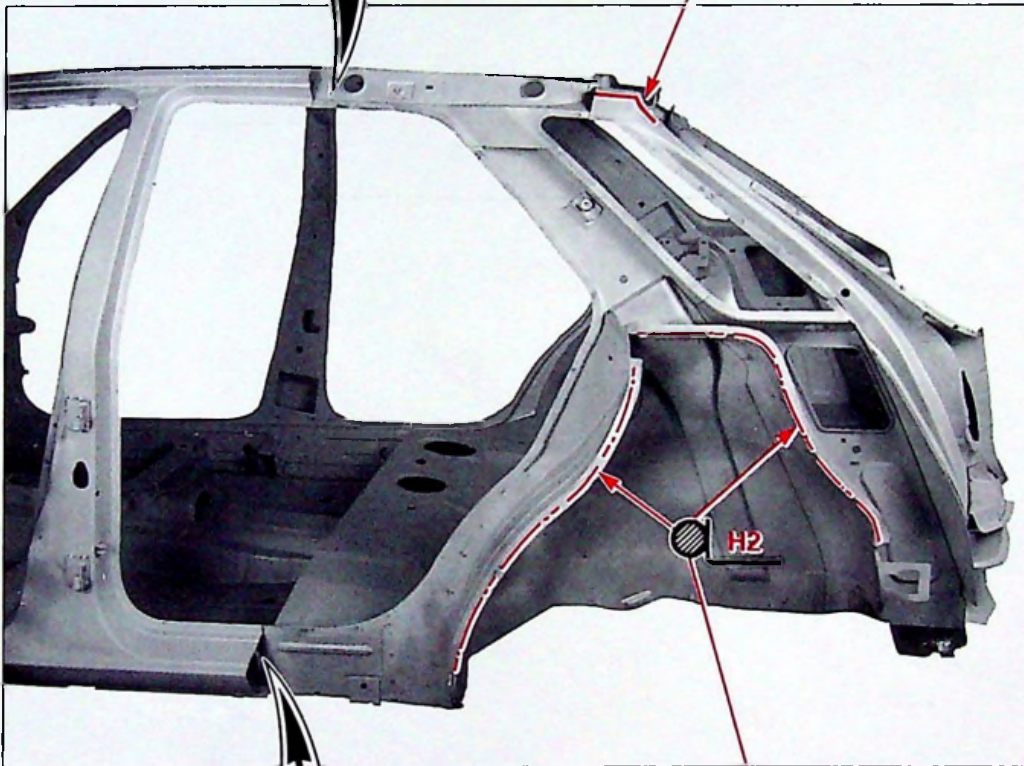

91-543

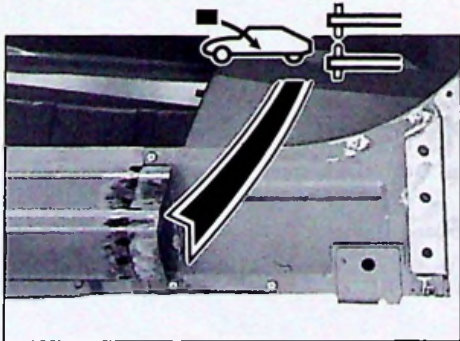

90-1219

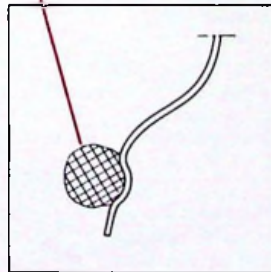

TT. 82-5



14



ZX
821-3/5

7

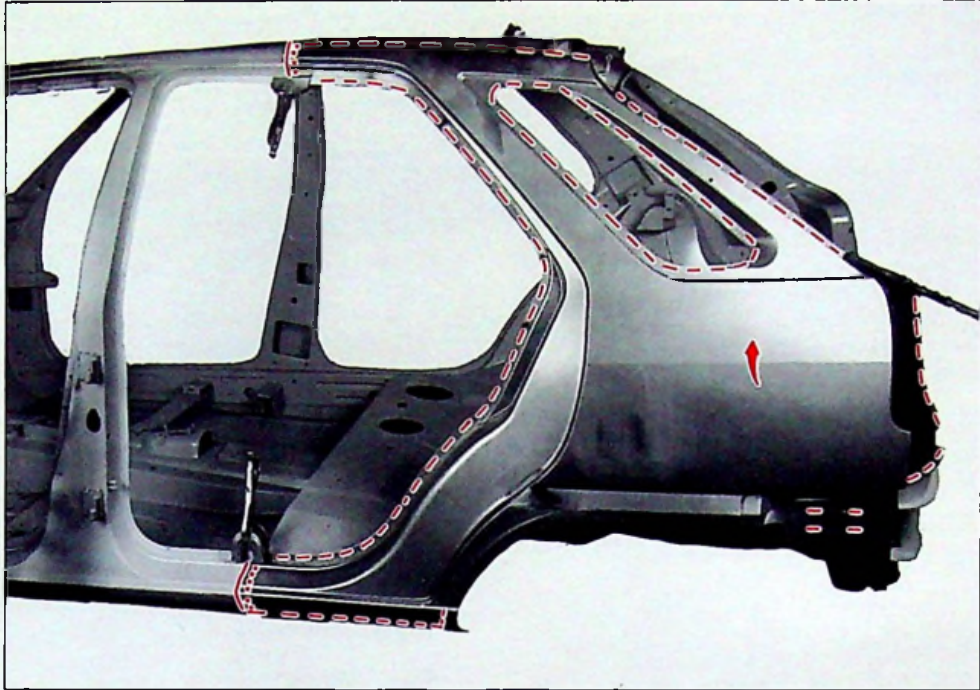

91-540

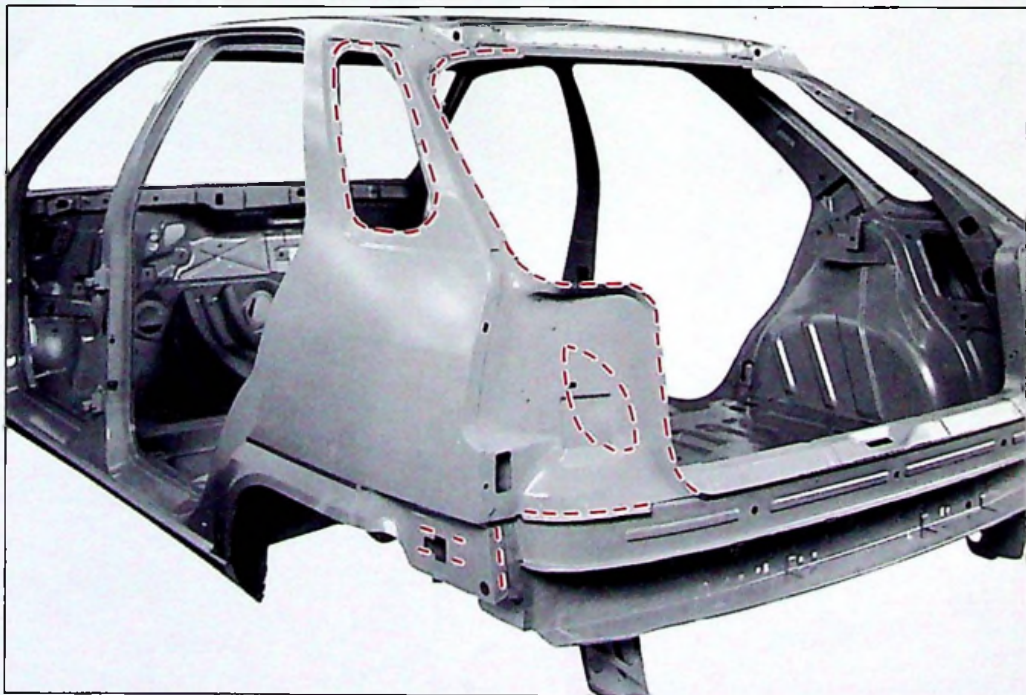
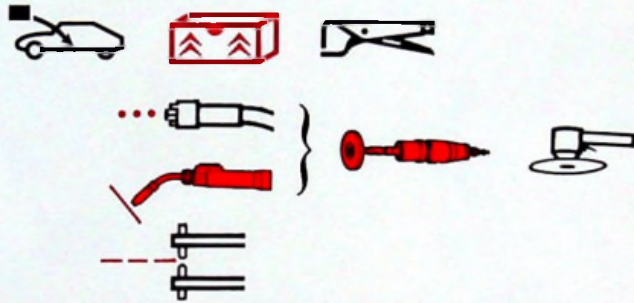

90-964

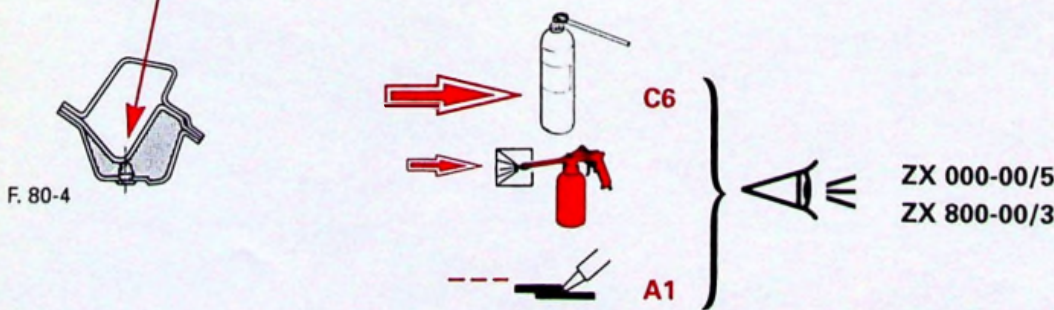
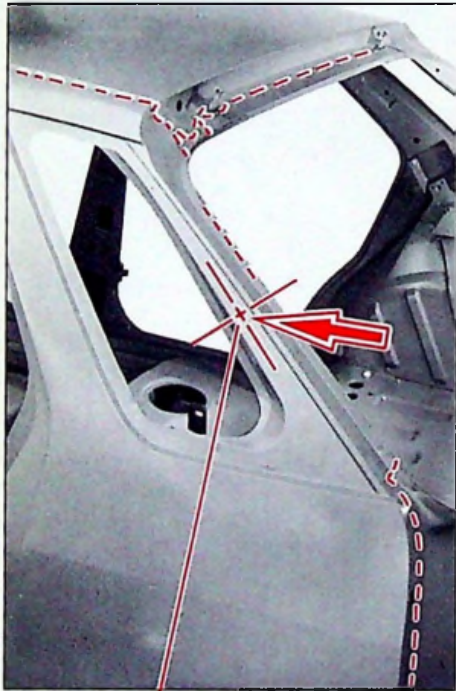
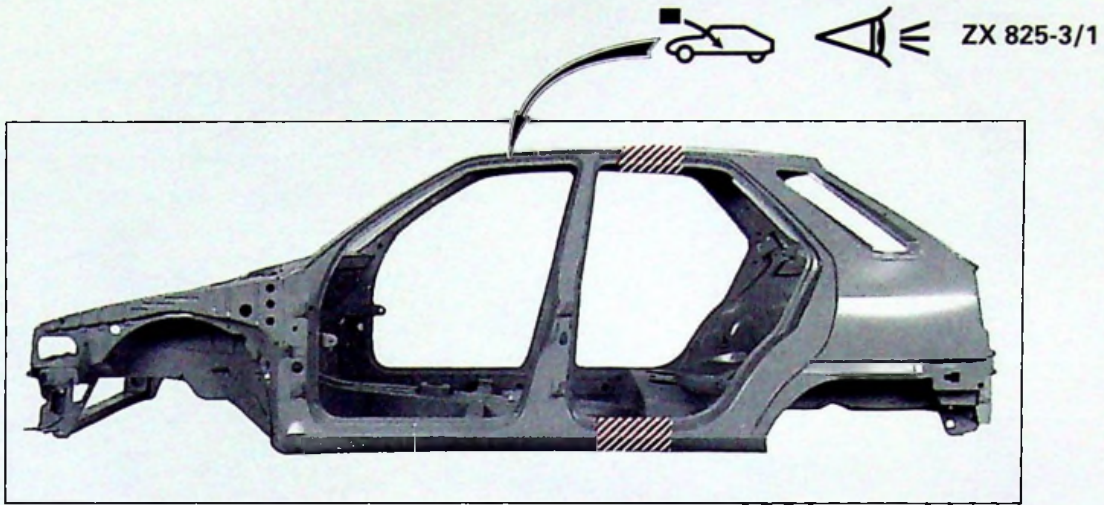



14



ZX
821-3/5

9

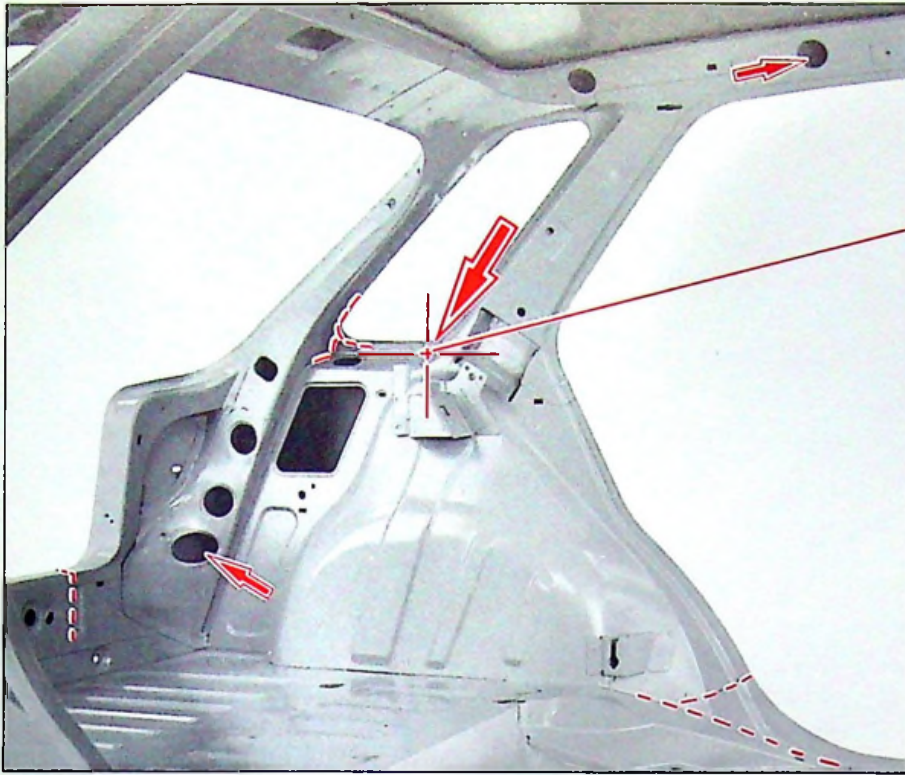

90-1098

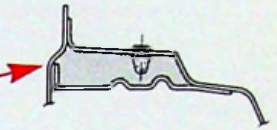

F. 80-4

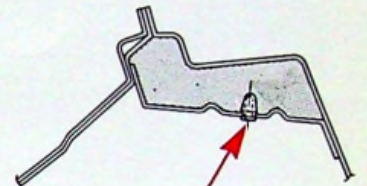

F. 80-4



C6

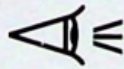

ZX 000-00/5
ZX 800-00/3

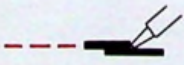

A1



C1

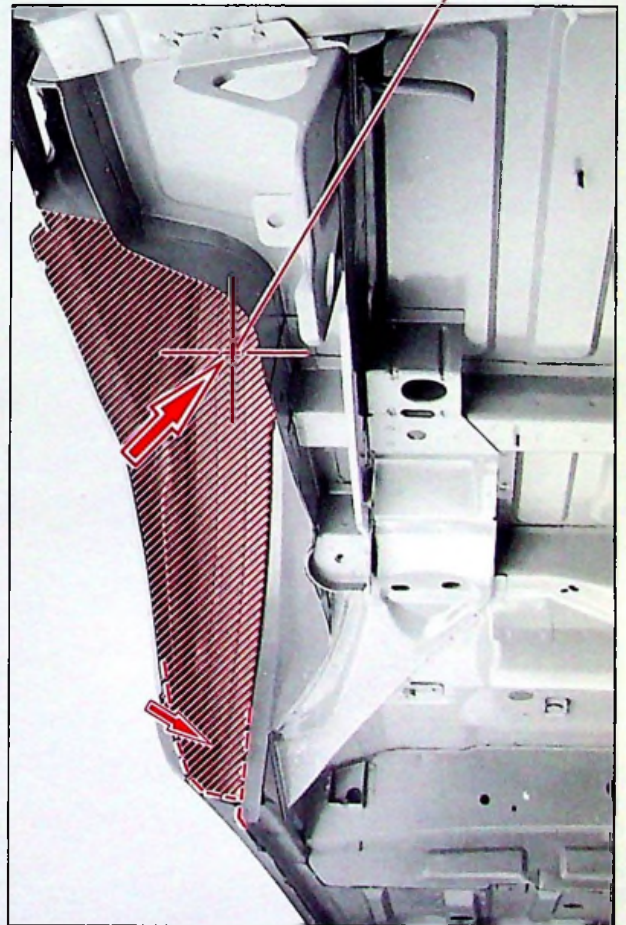

90-1072



14



ZX
821-3/6

1

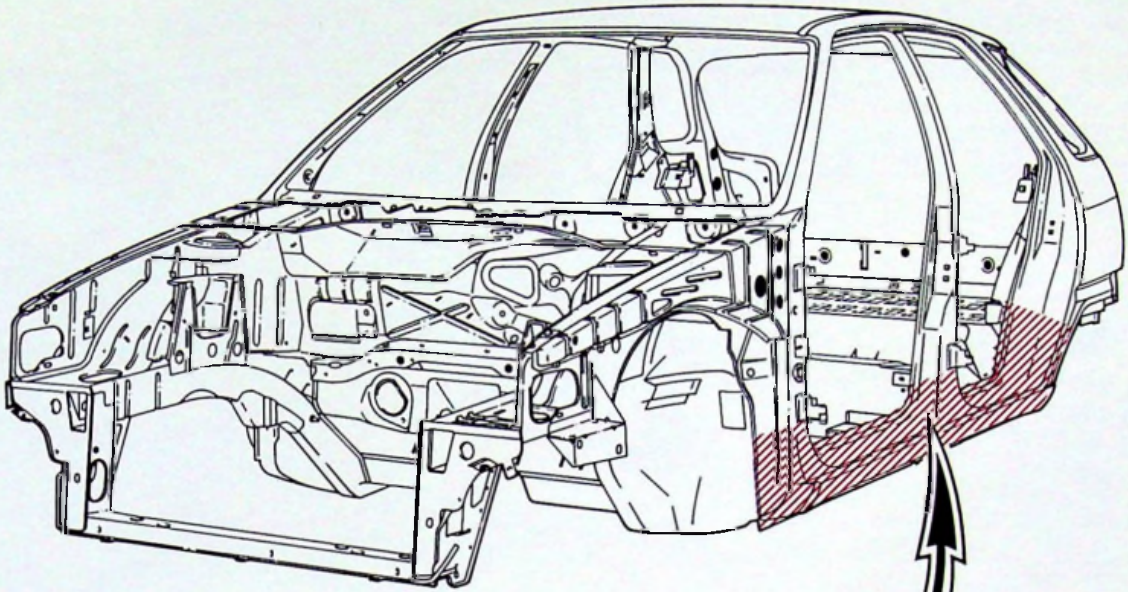

F.80-10

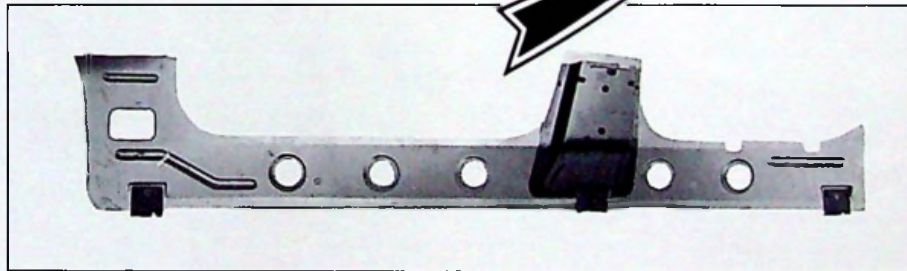

90-1170

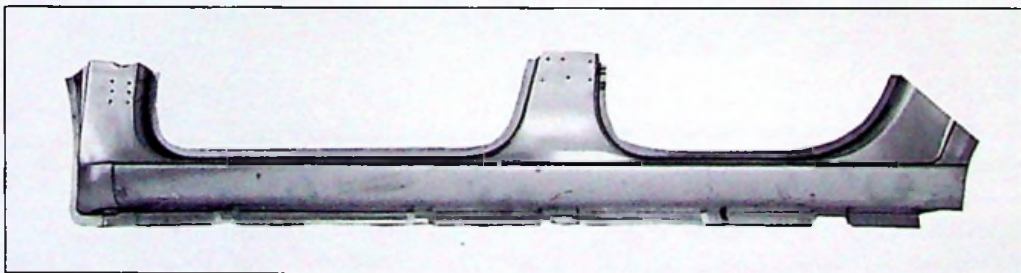

90-1168

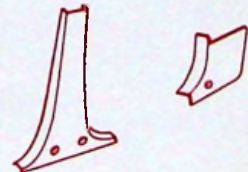
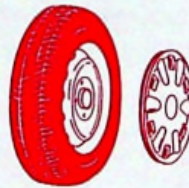
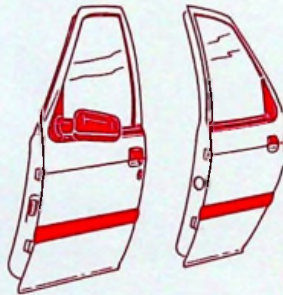
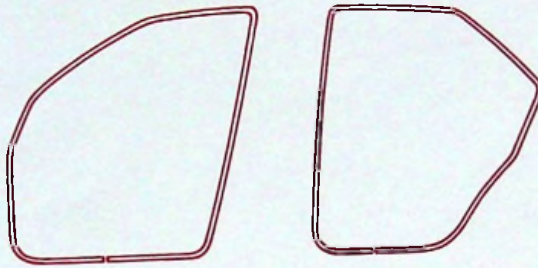
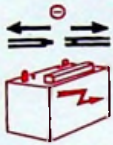
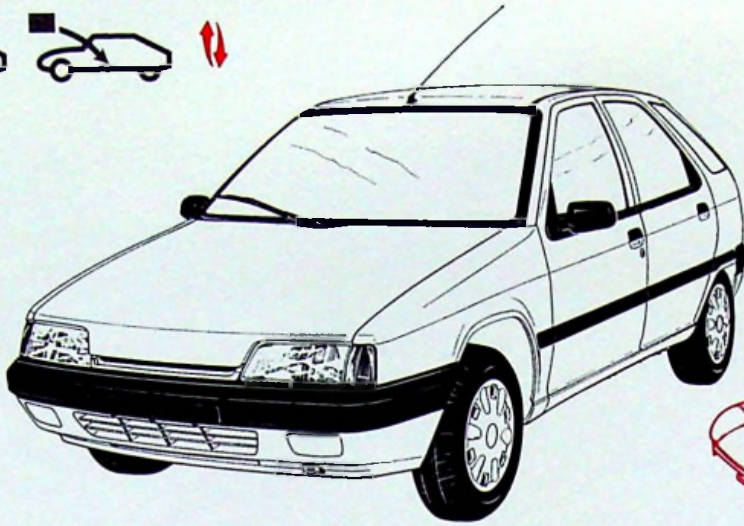
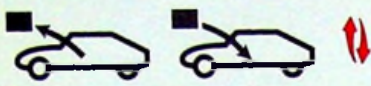

- F. 80-12
- F. 80-20
- F. 80-28
- F. 91-1



14



ZX
821-3/6

3

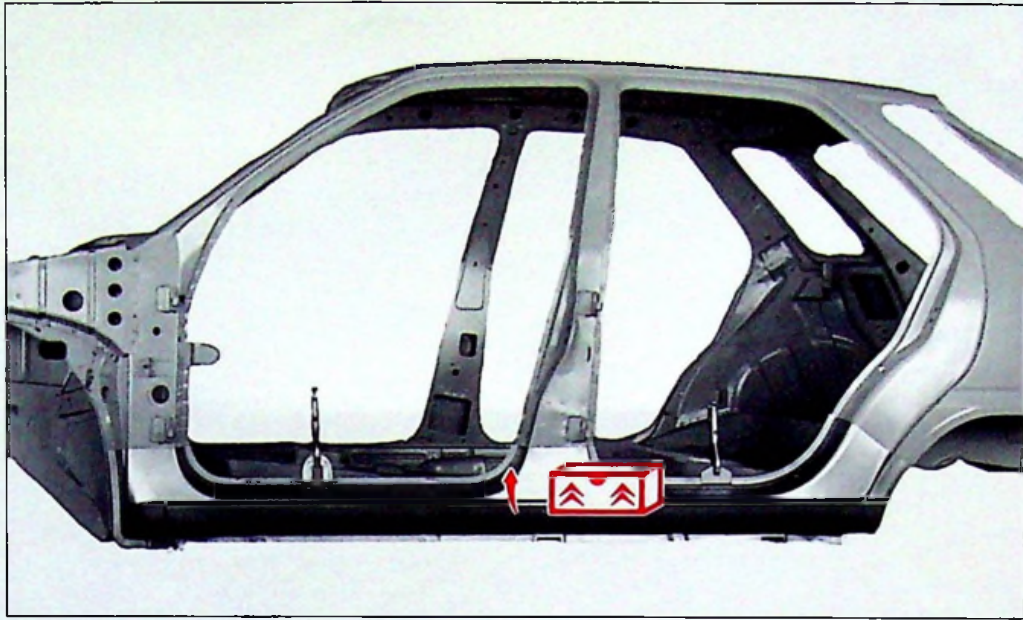

91-563

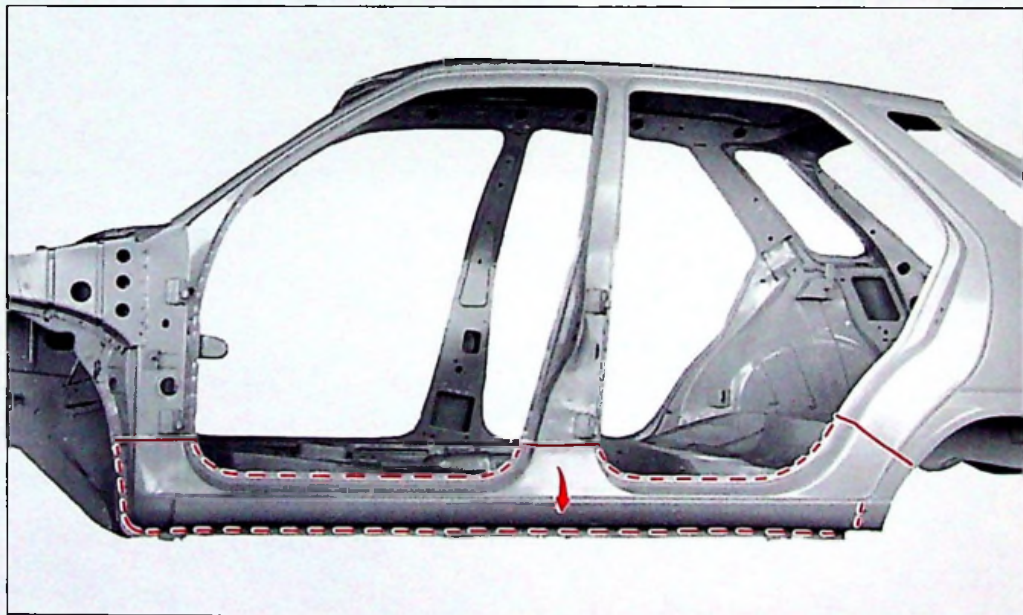
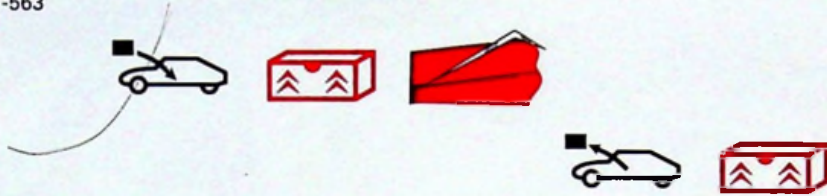

91-562

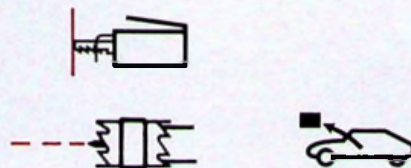

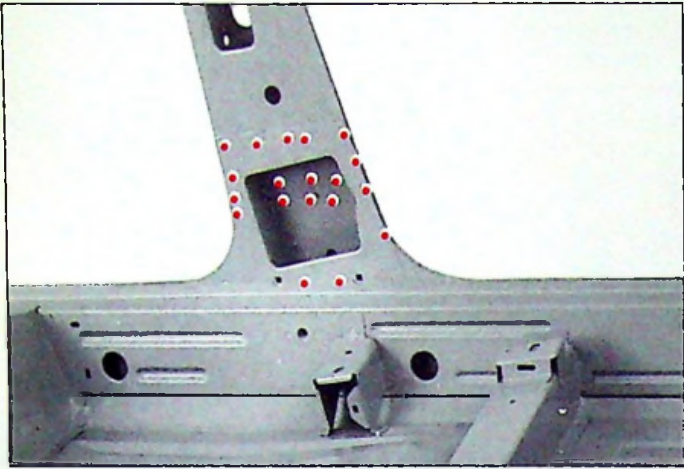

90-1095

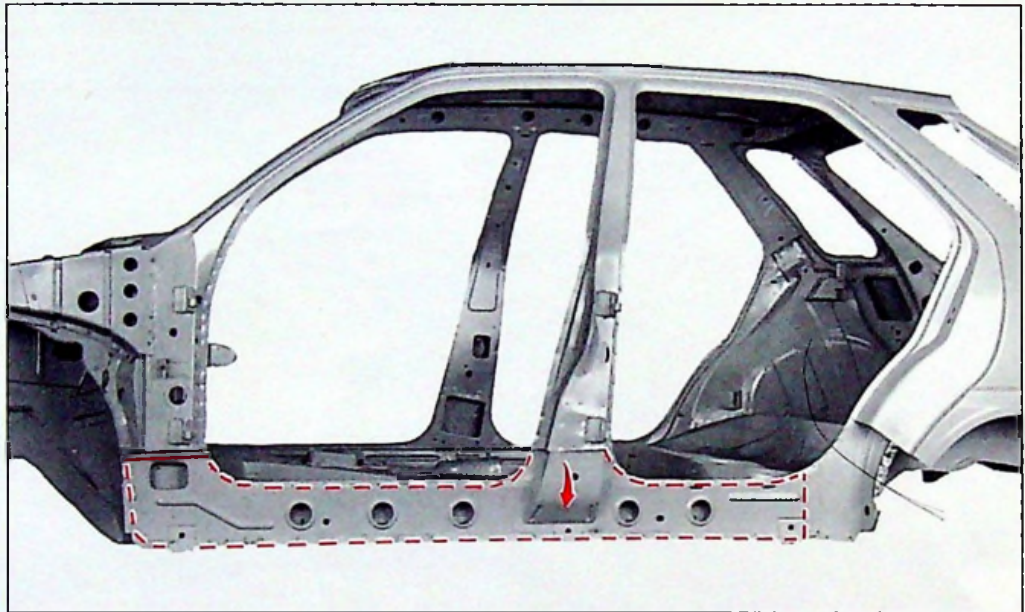
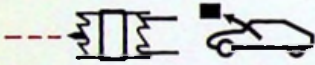
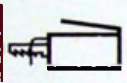

91-567

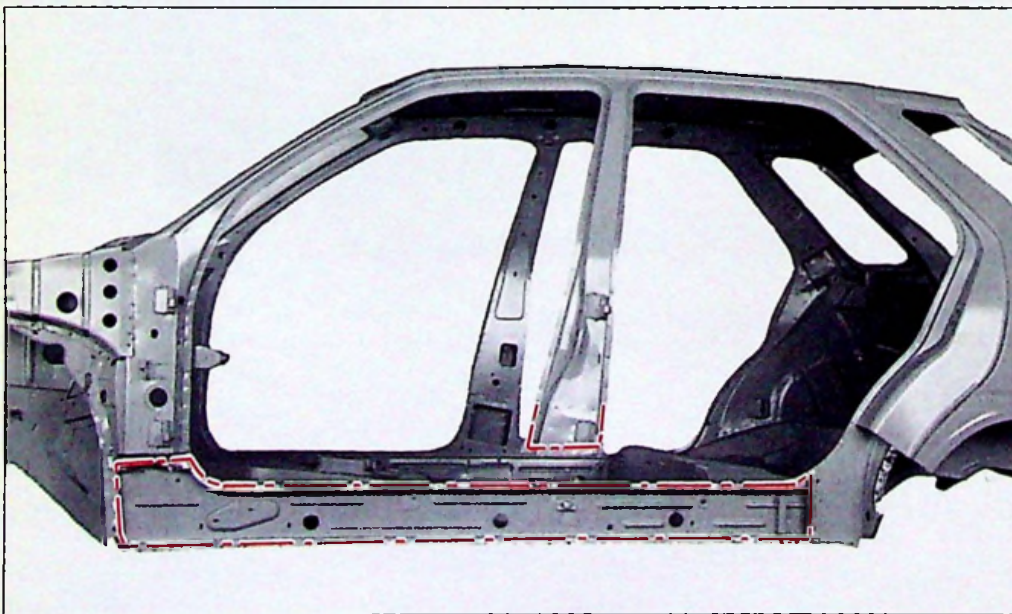

91-565

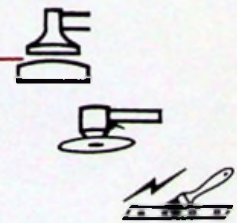



14



ZX
821-3/6

5

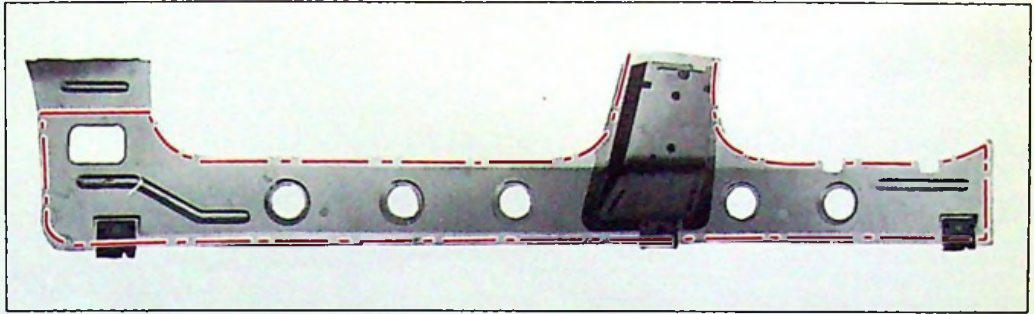

90-1170

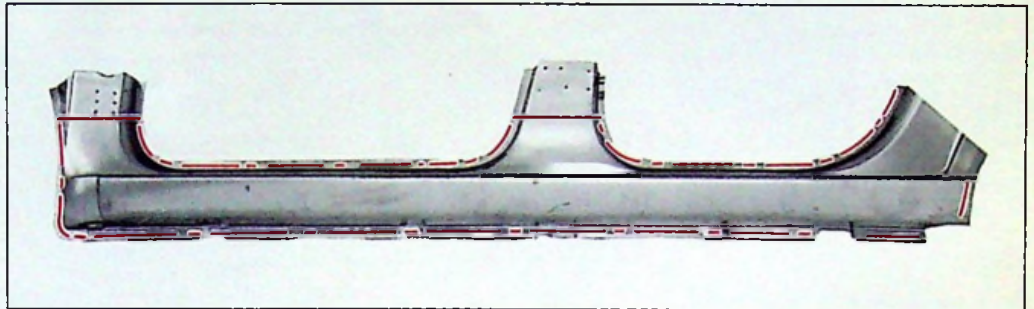

90-1168

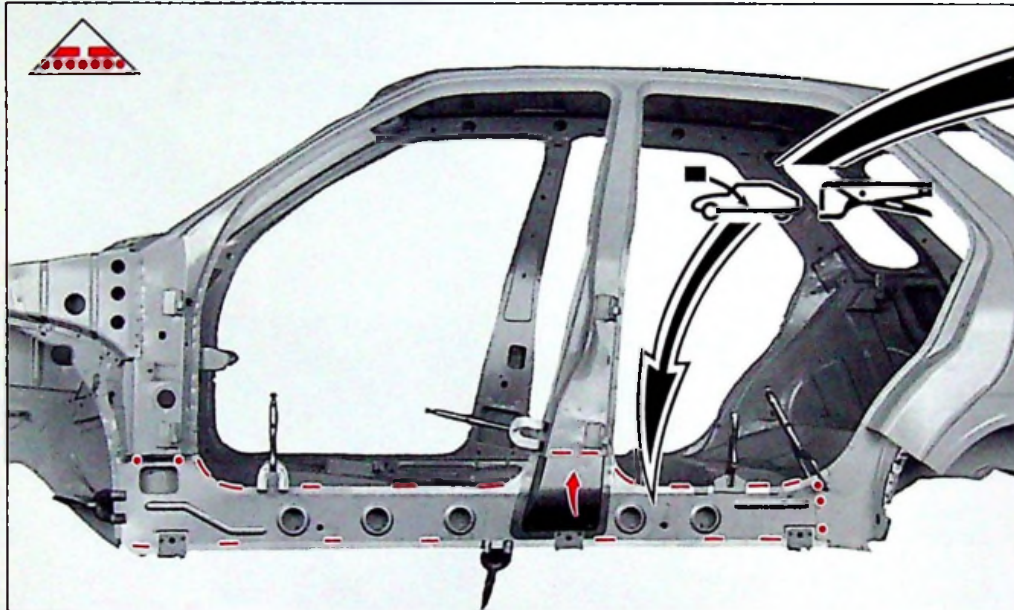

91-566

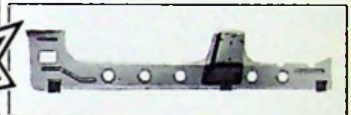

90-1170

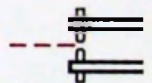
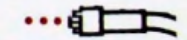

90-1168

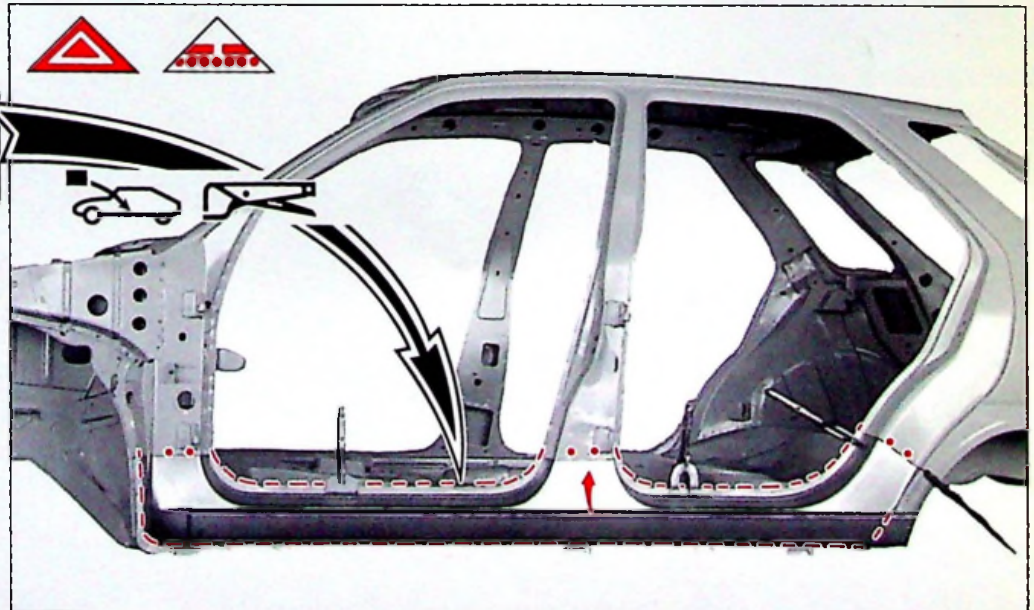

91-564

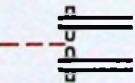
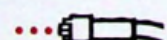

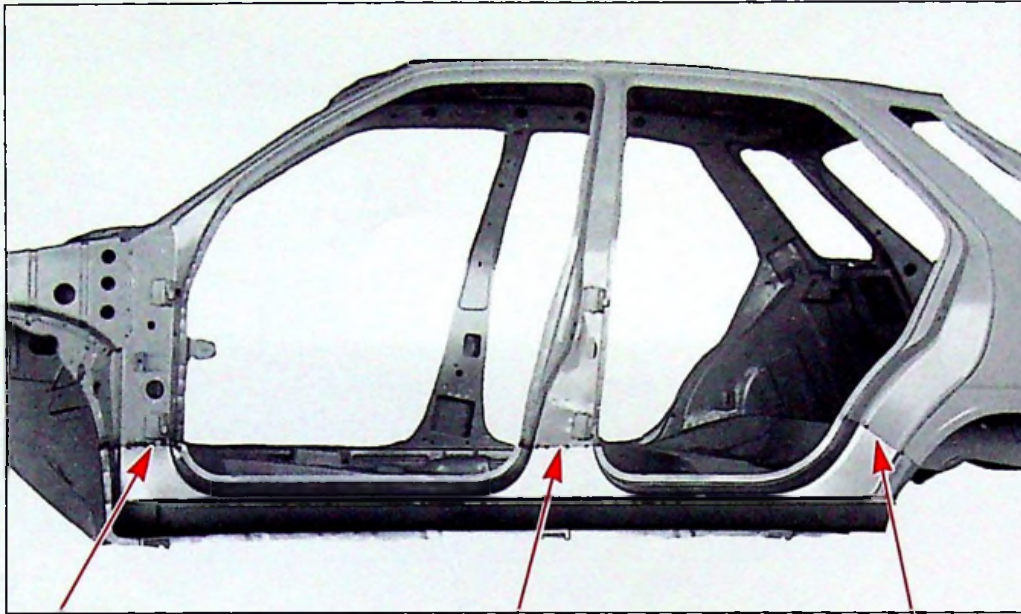

91-568

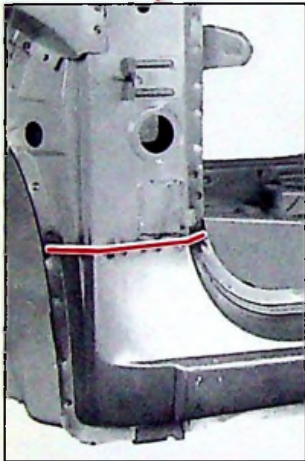

91-569

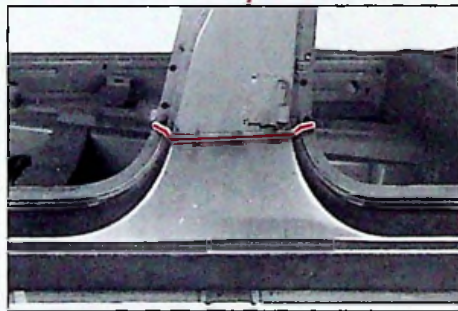

91-570

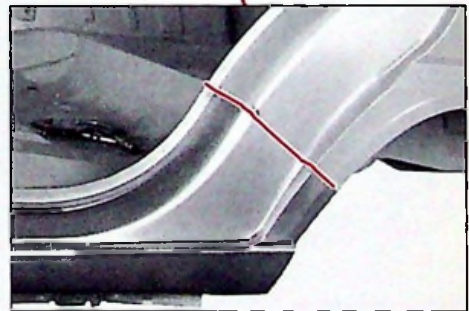

91-571





14



ZX
821-3/6

7

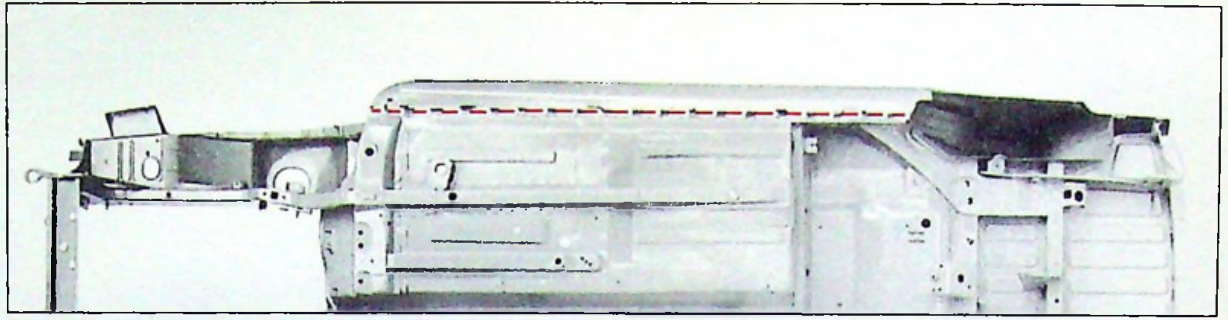

90-1070

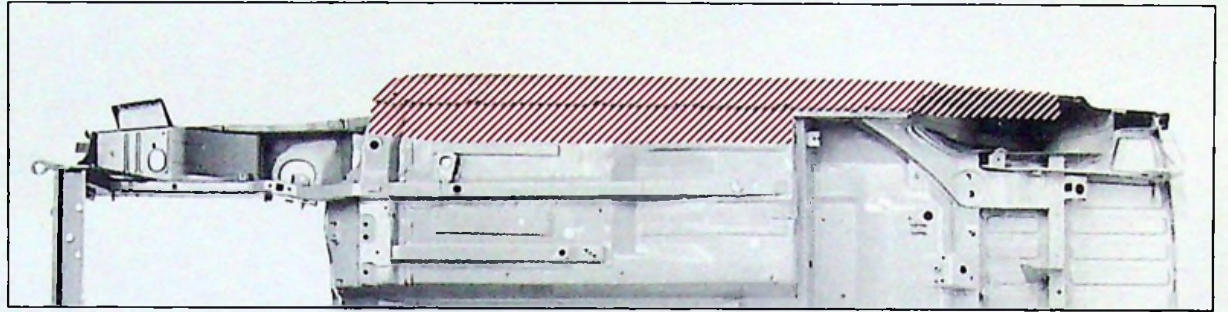

90-1070

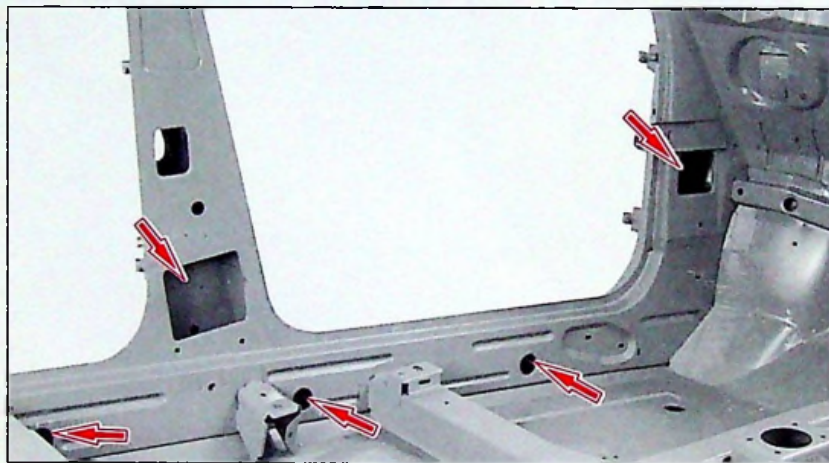

90-1097

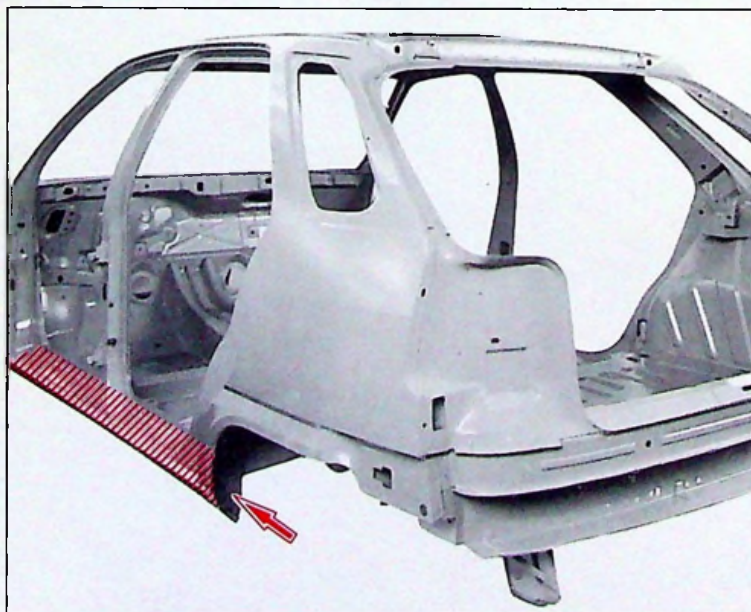

90-964

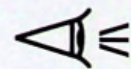
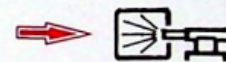
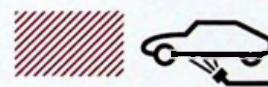

ZX 000-00/5

ZX 800-00/3



14



ZX
821-3/7

1

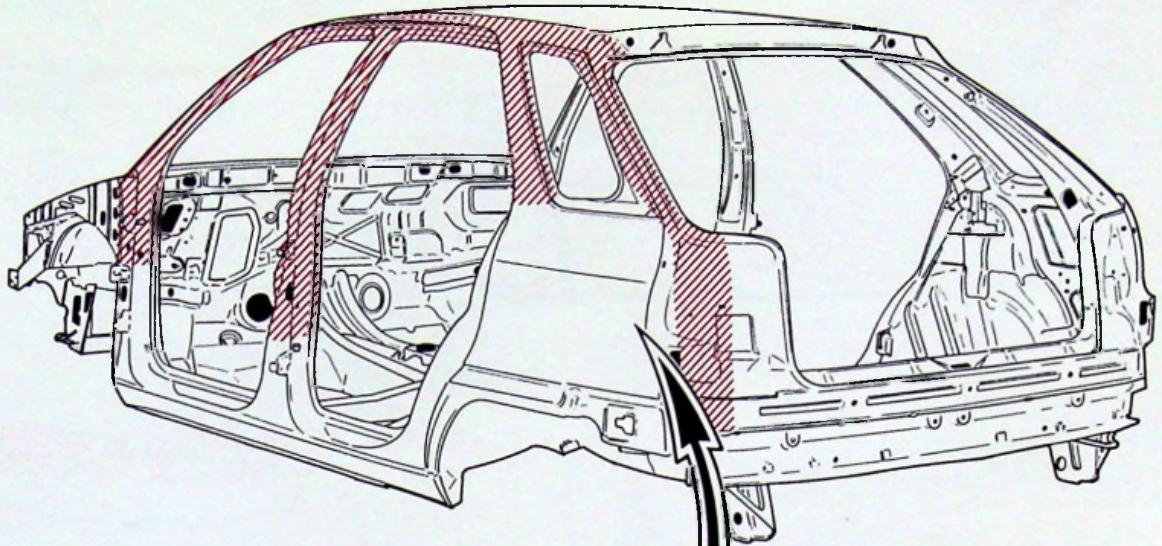

F.80-11

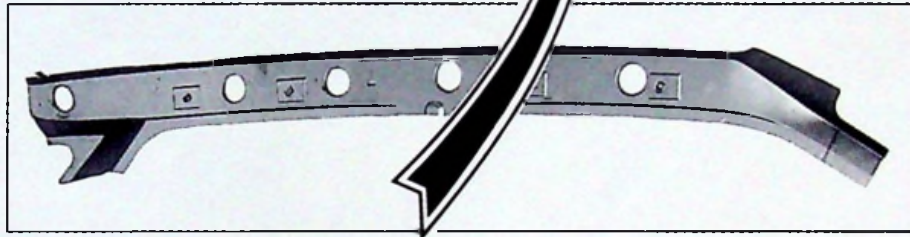

90-1143

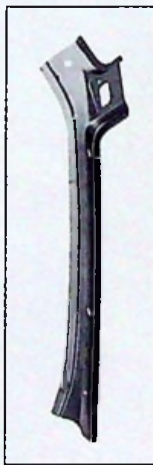

90-1144

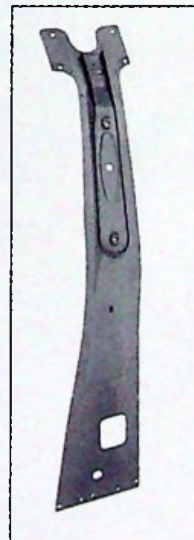

90-1758

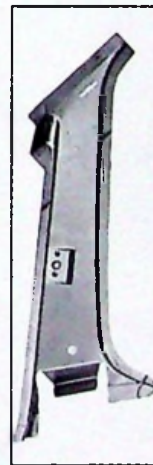

90-1145

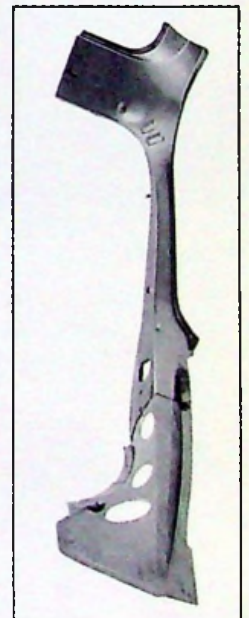

90-1137



90-1138

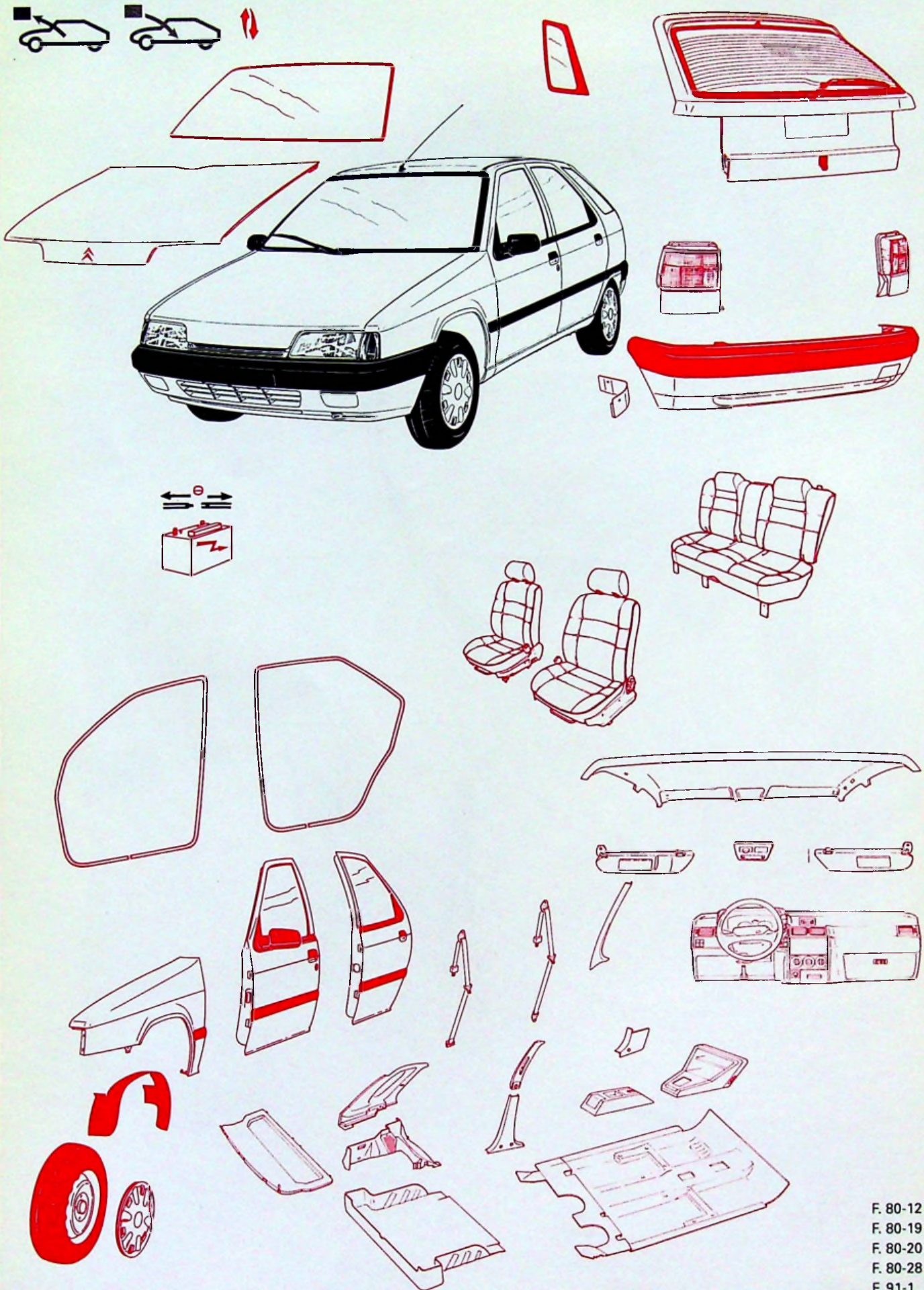

F. 80-12
 F. 80-19
 F. 80-20
 F. 80-28
 F. 91-1



14



ZX
821-3/7

3

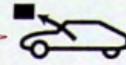

ZX 825-3/1

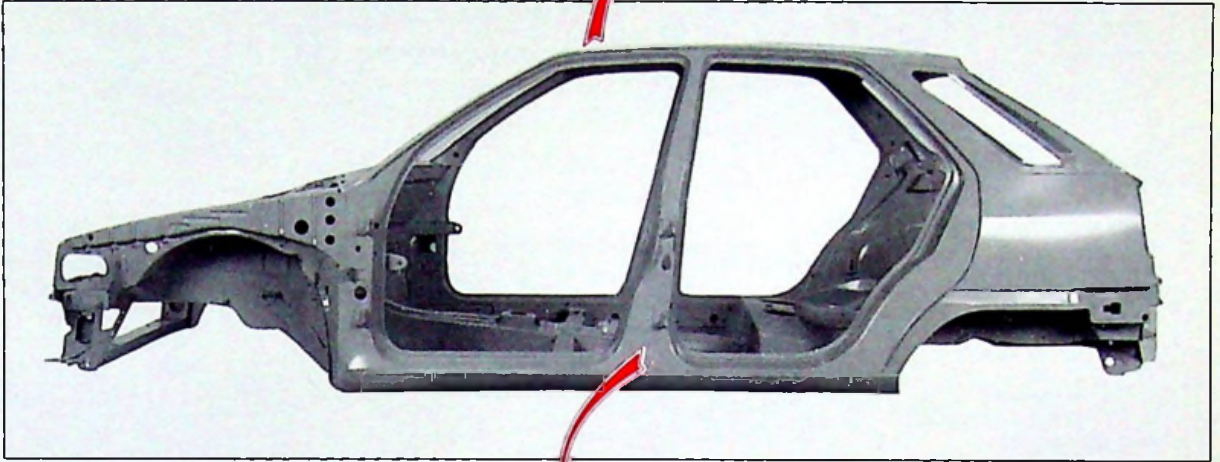

90-1084

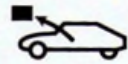

ZX 821-3/1

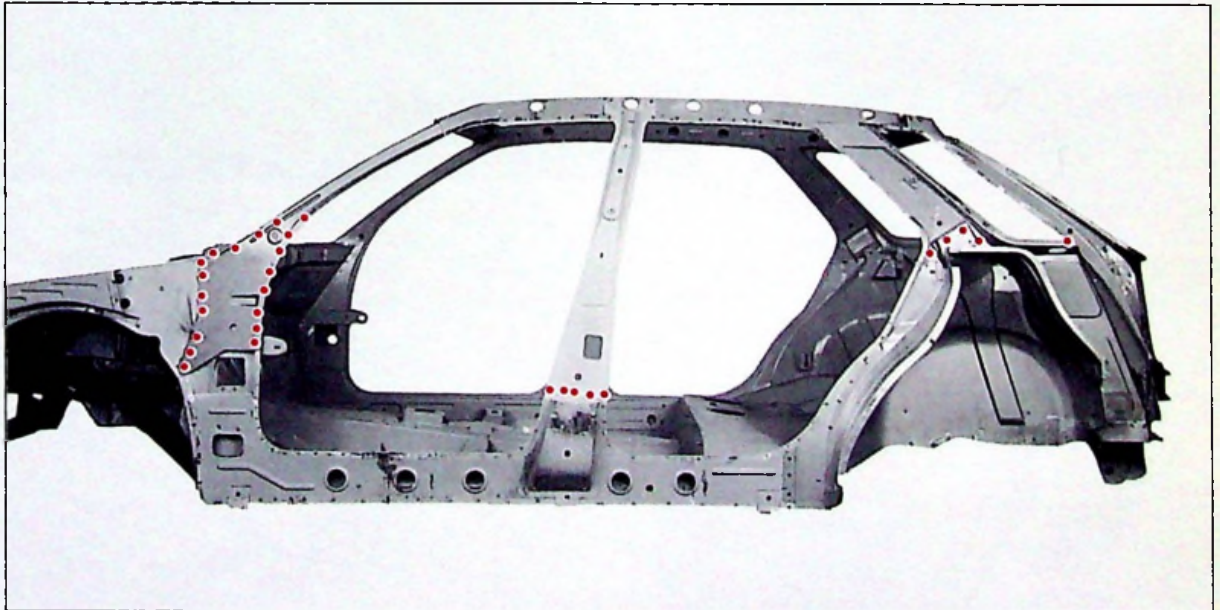

90-1776



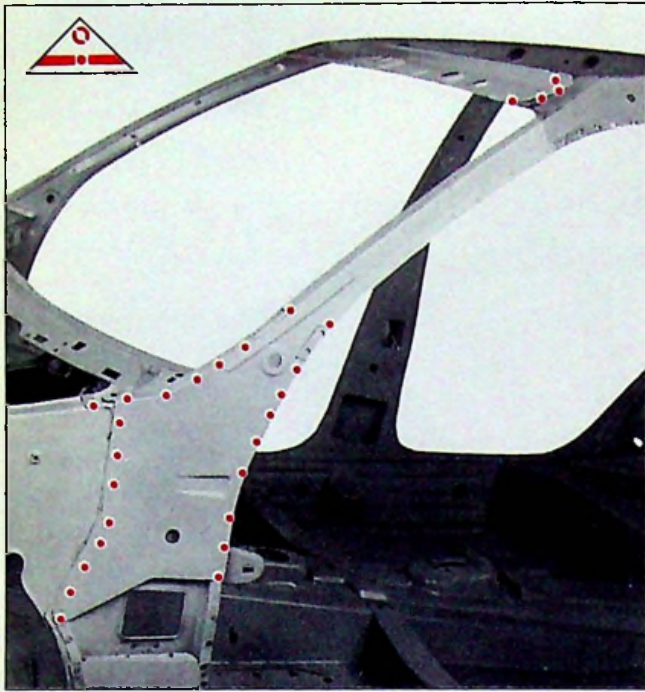

90-1696

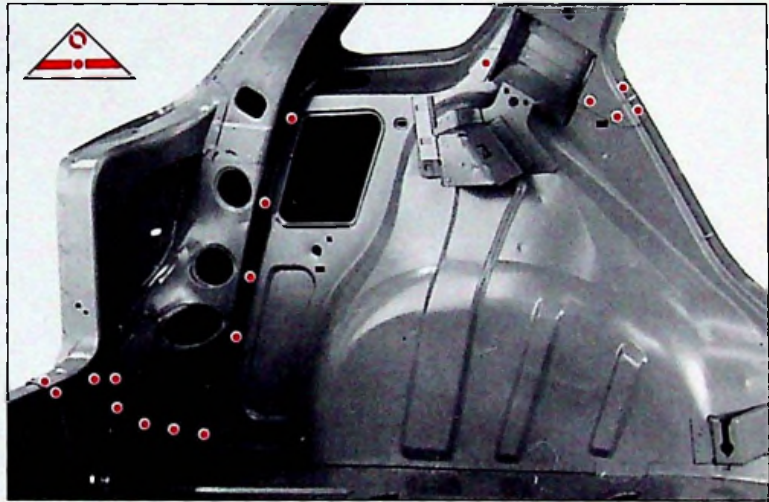

90-1099

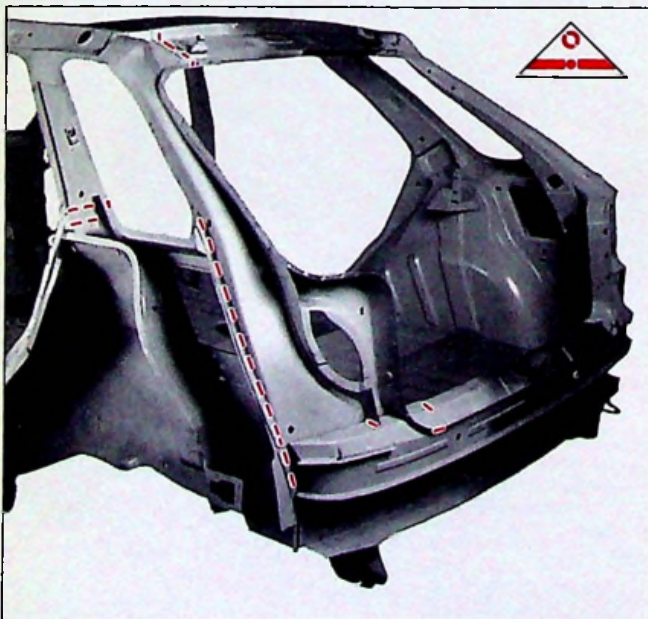

91-542

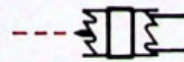



14



ZX
821-3/7

5

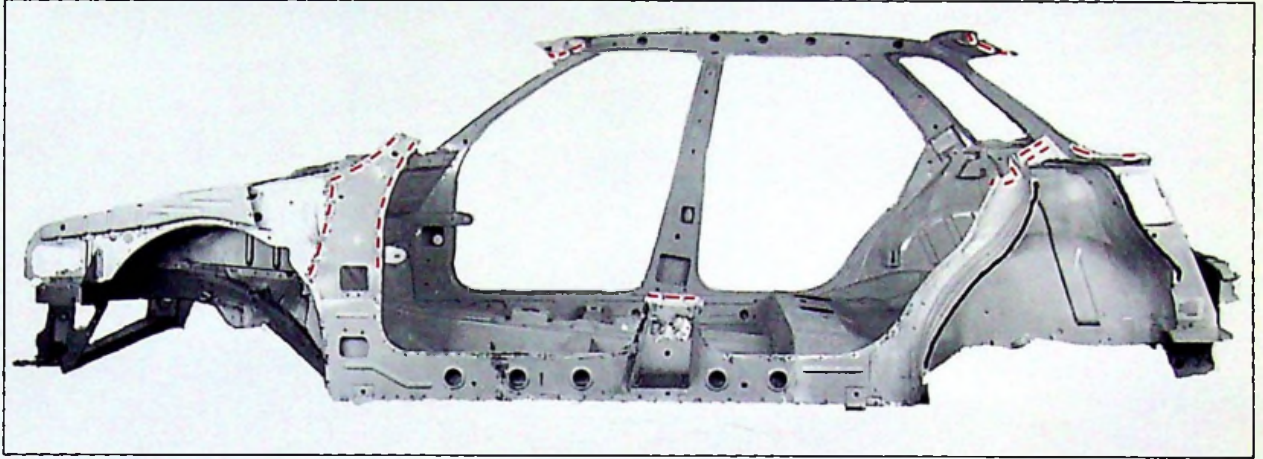

91-737



91-739



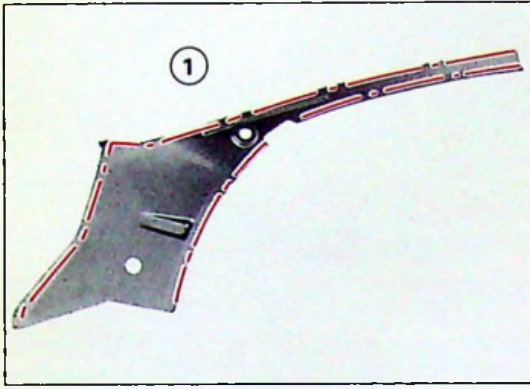

90-1138

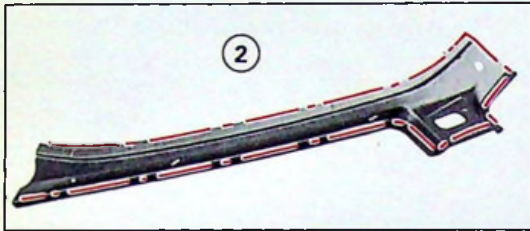

90-1144

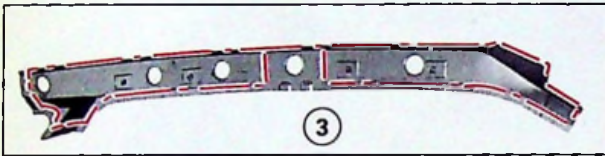

90-1143

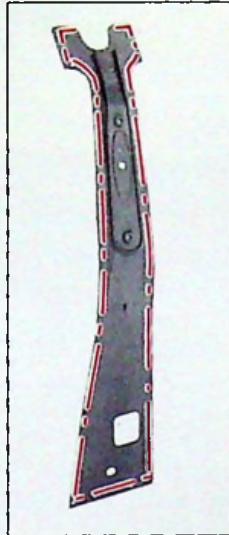

90-1758

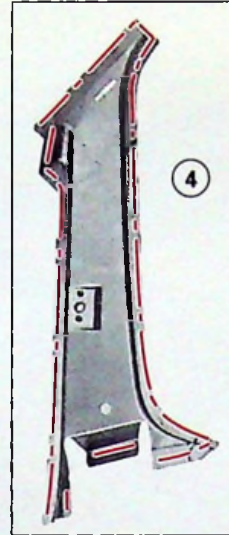

90-1145



90-1137

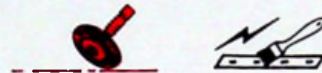

+++  Ø = 6 mm

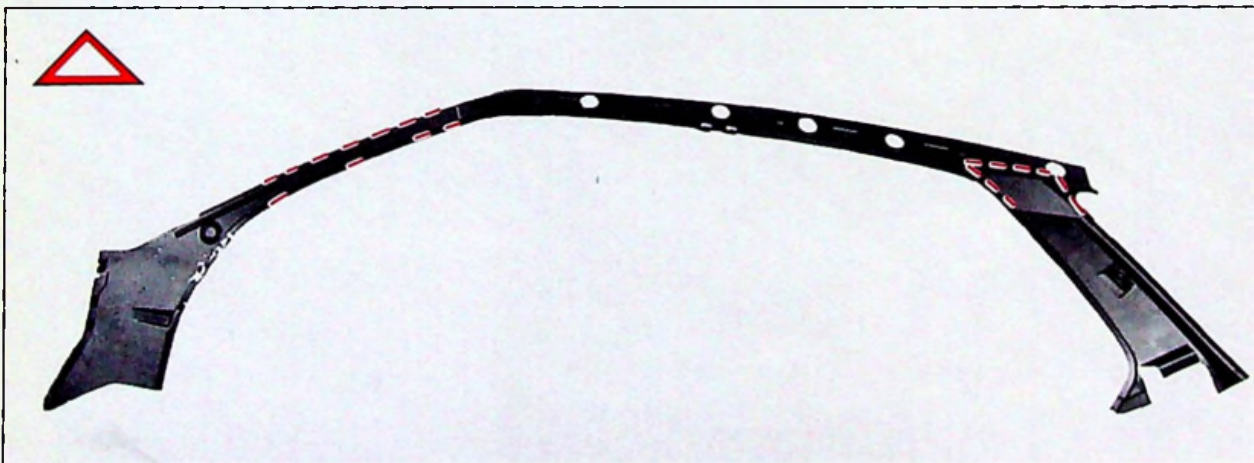

91-740

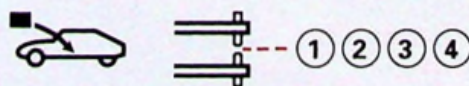



14



ZX
821-3/7

7

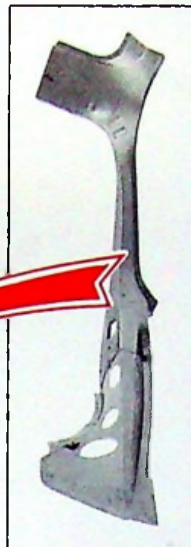
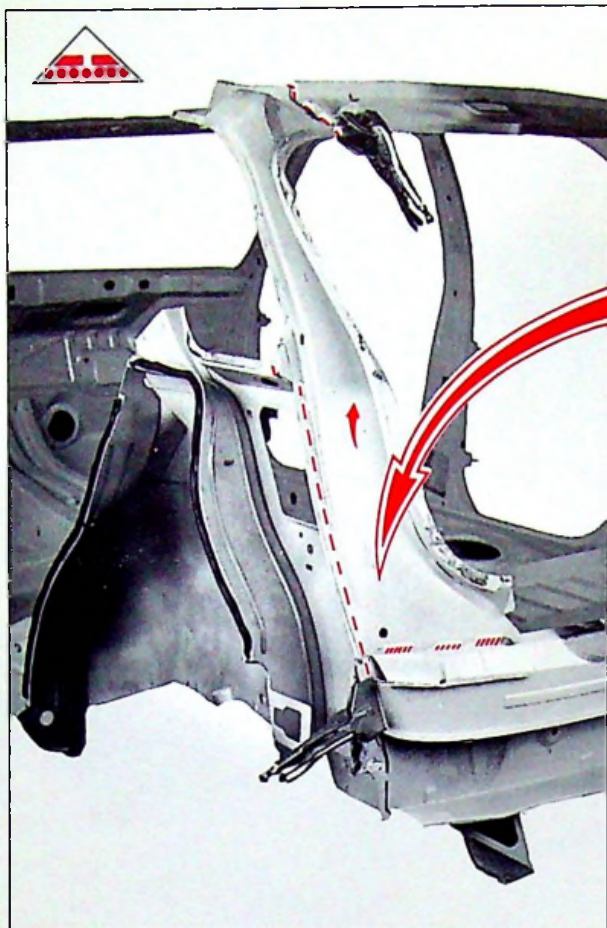

91-738

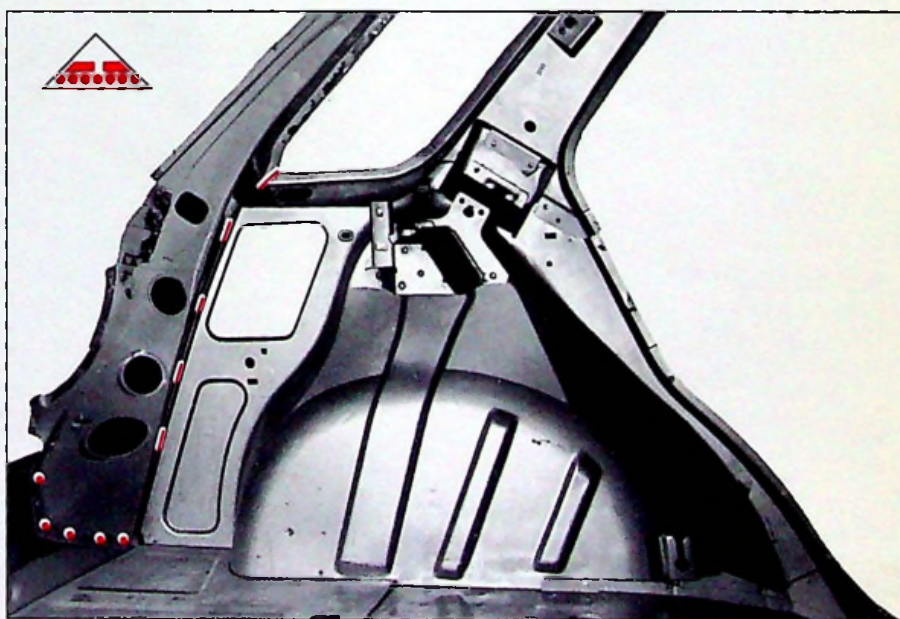
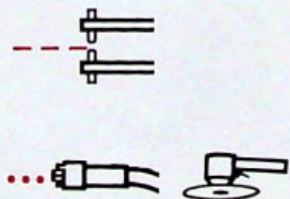
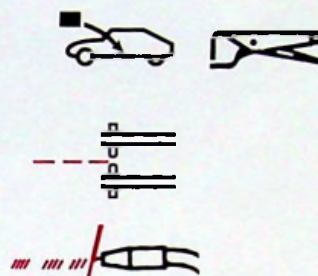

91-744

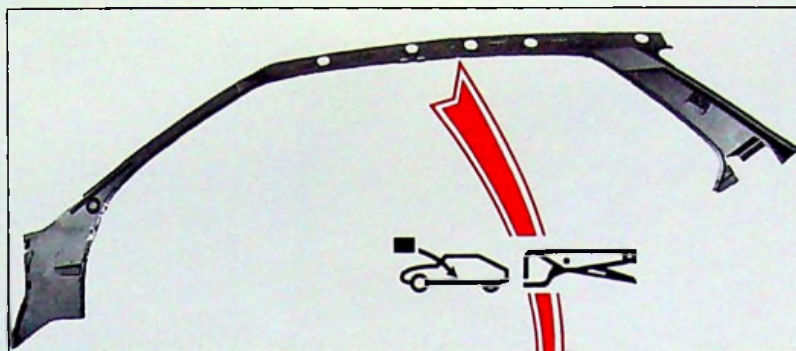

91-740

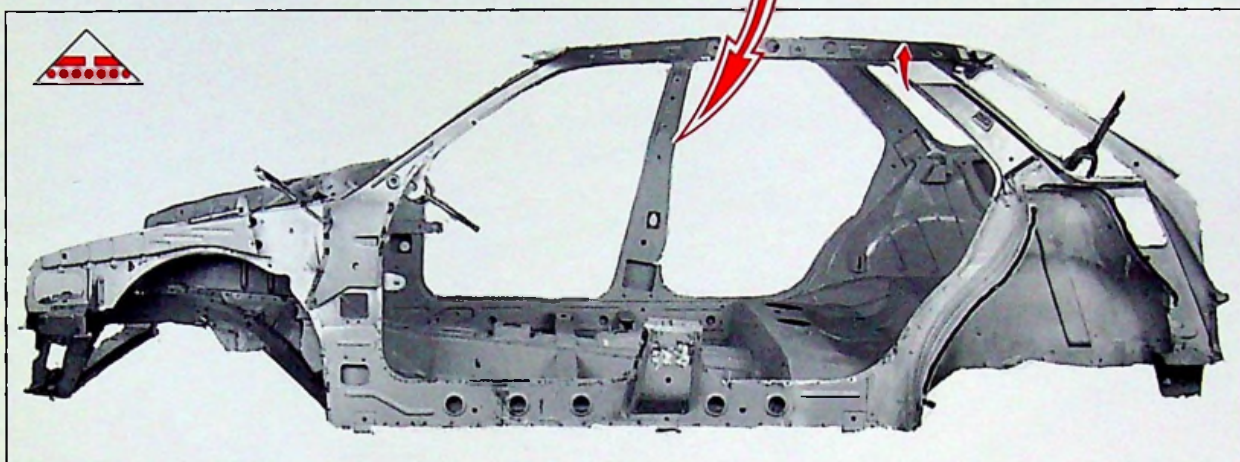

91-742

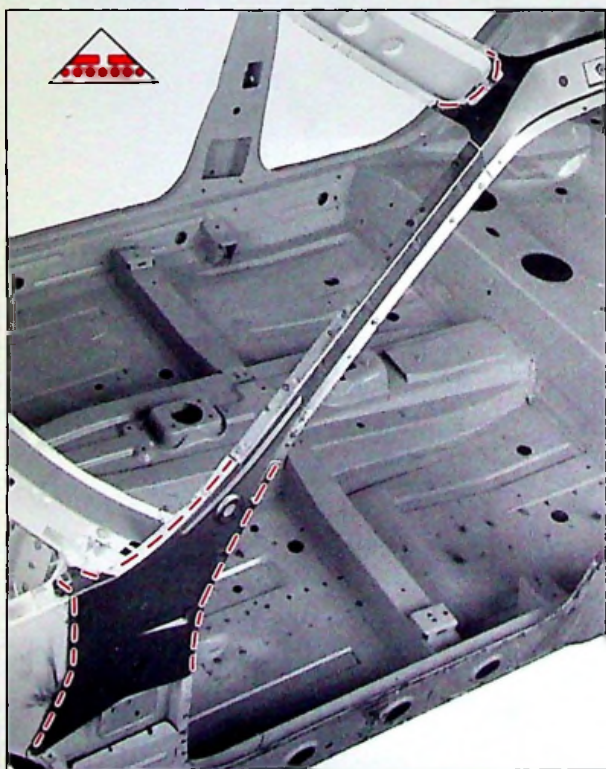
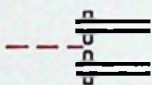

91-745

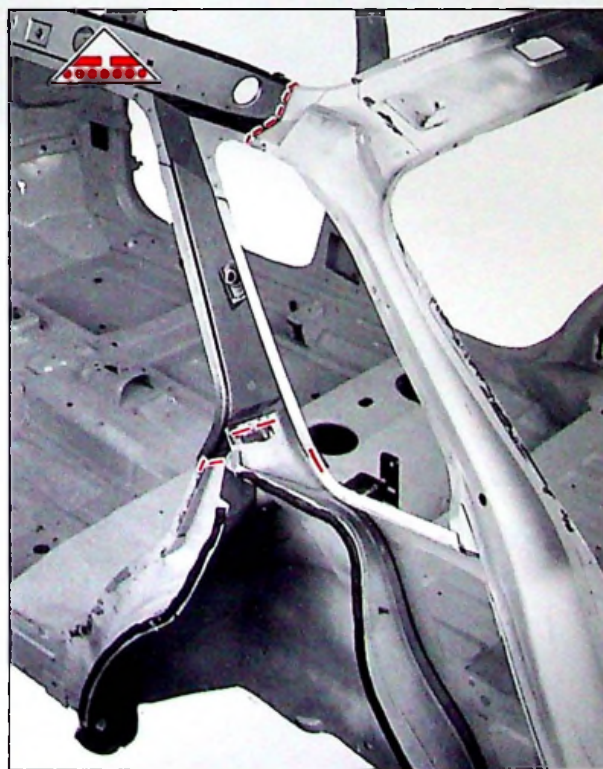

91-741



14



ZX
821-3/7

9

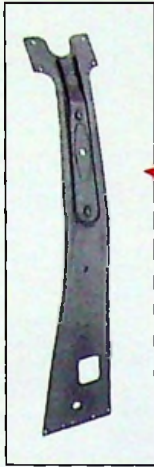

90-1758

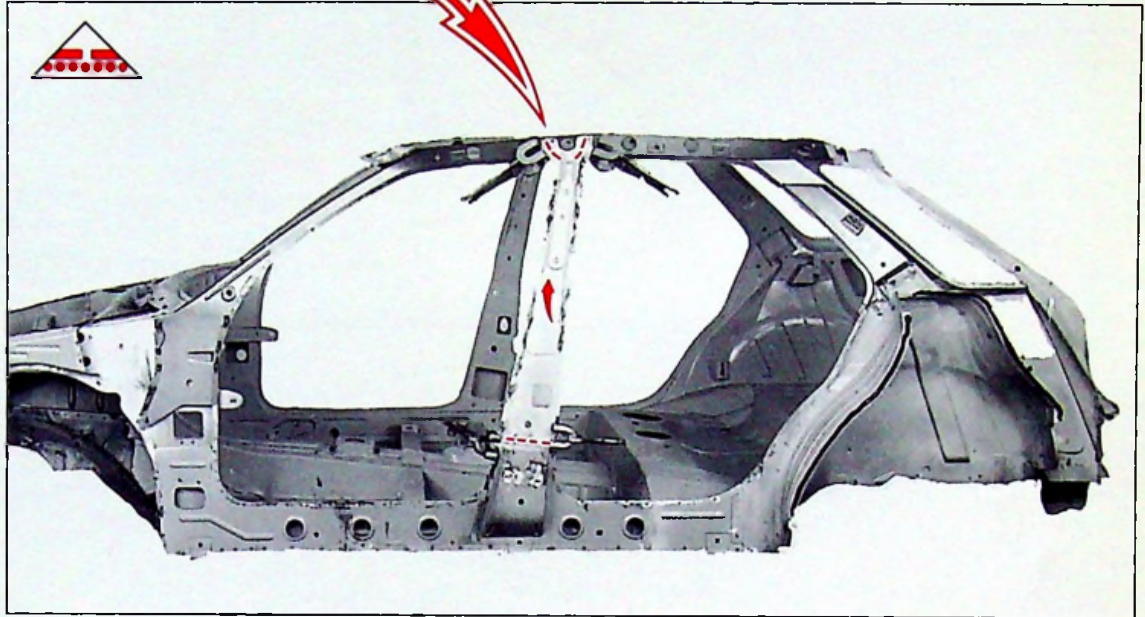
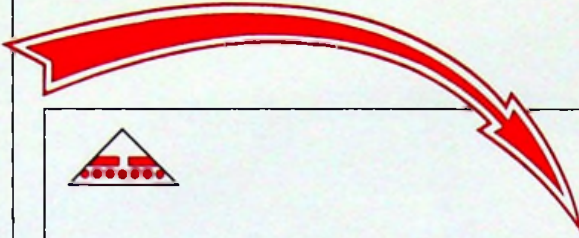
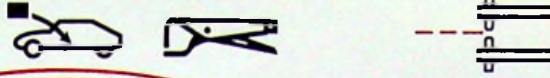

91-743

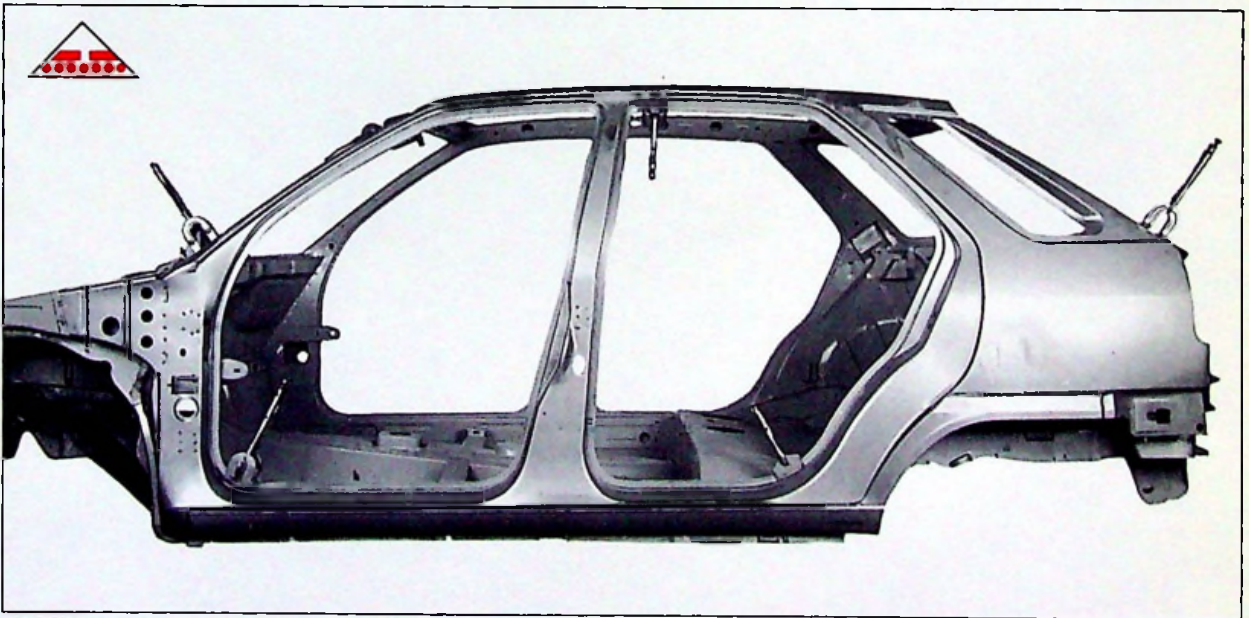

90-1777

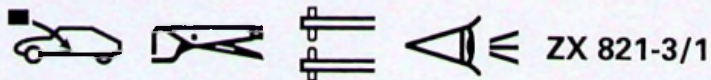

ZX 821-3/1

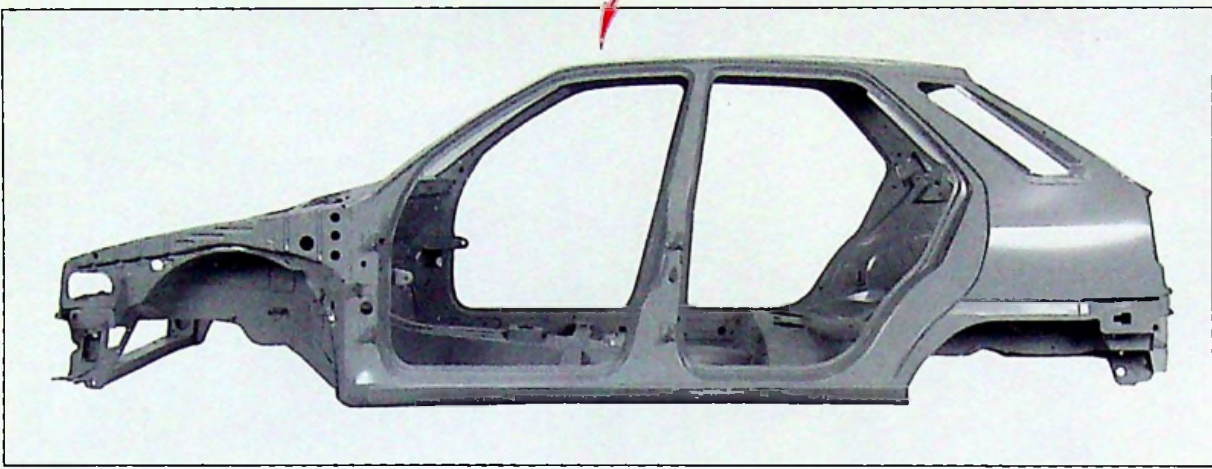
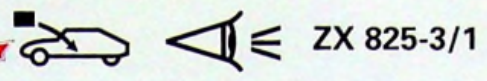

90-1084

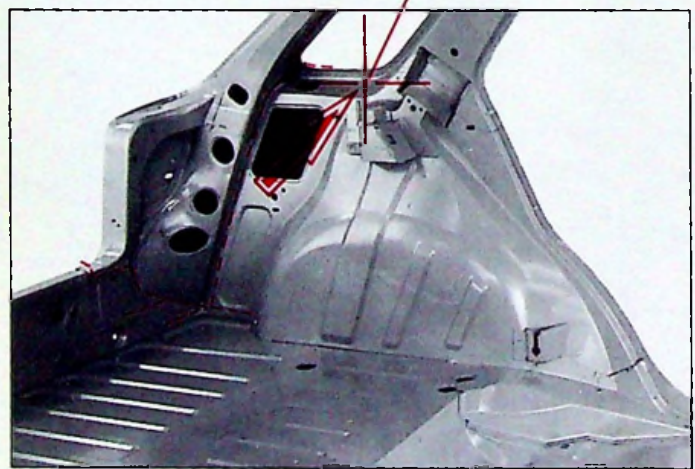
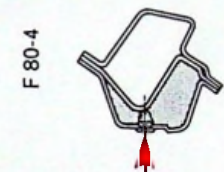
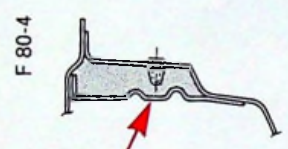

90-1099

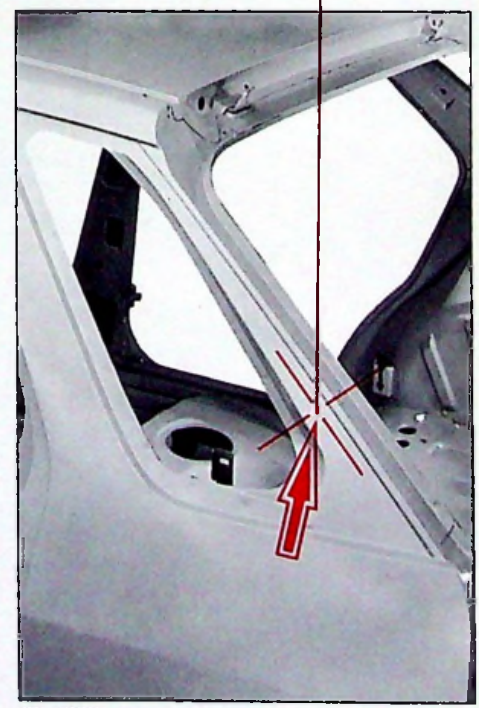

90-1087

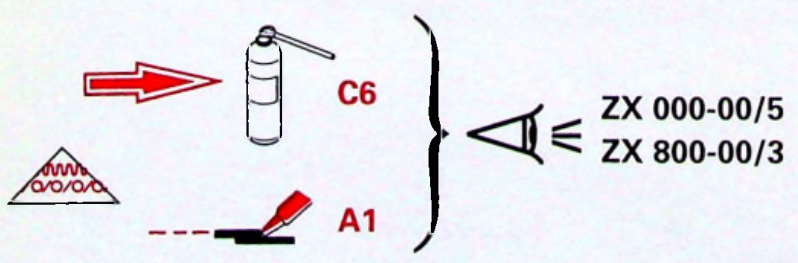



14



ZX
821-3/7

11

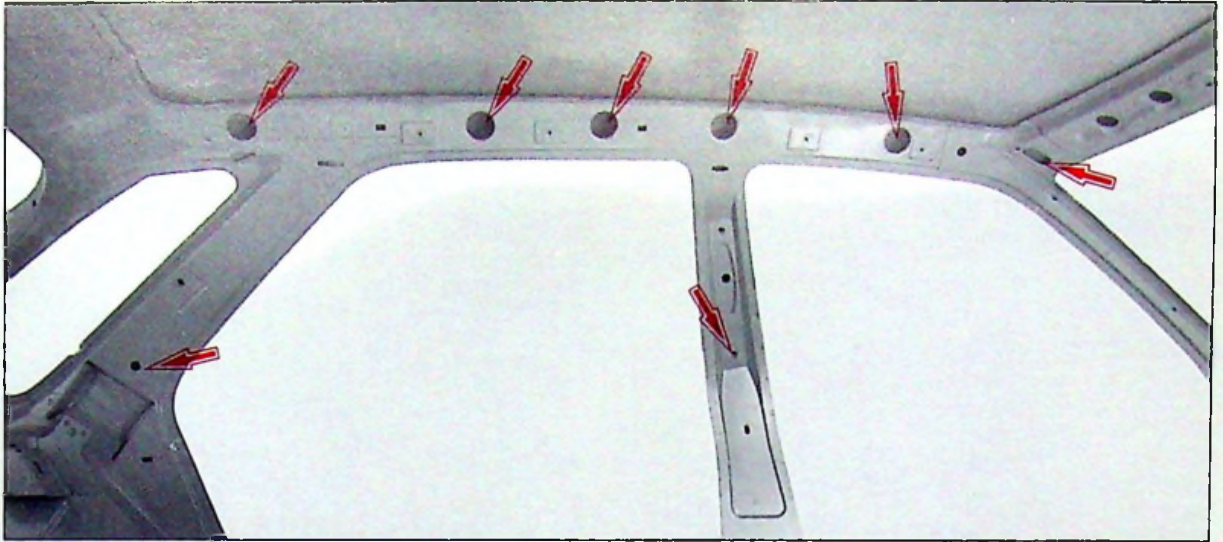

90-1092



90-1079

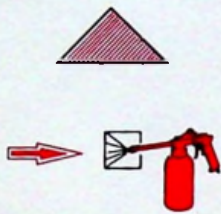

90-1098

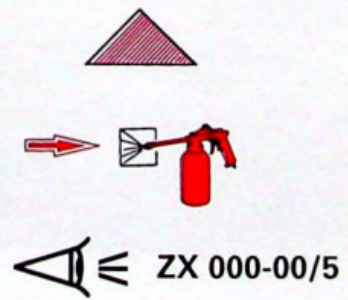



14



ZX
821-3/8

1

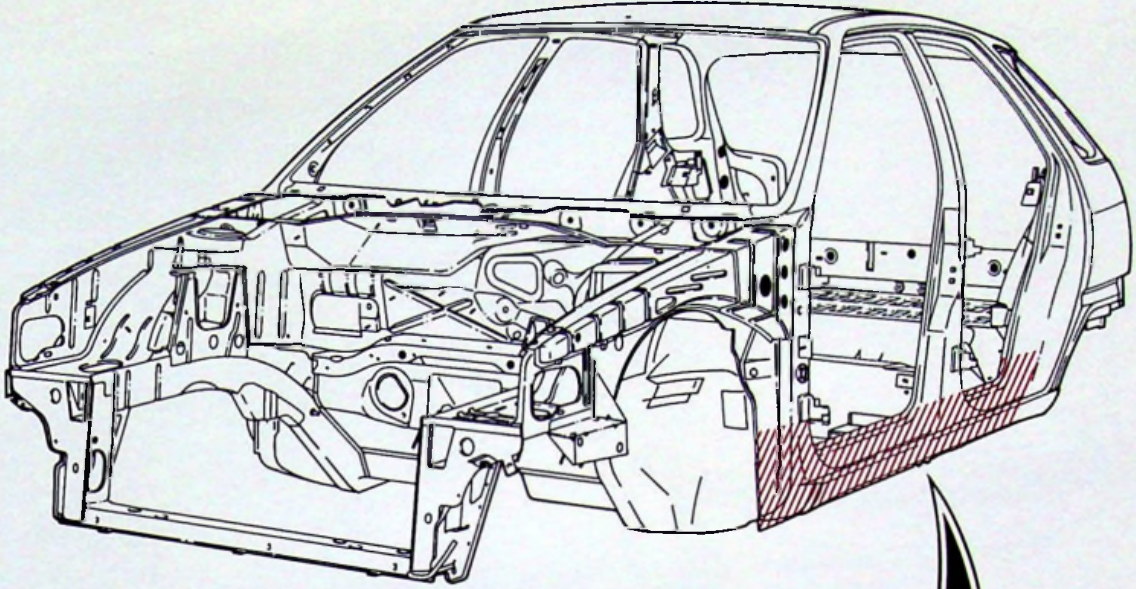

F.80-10

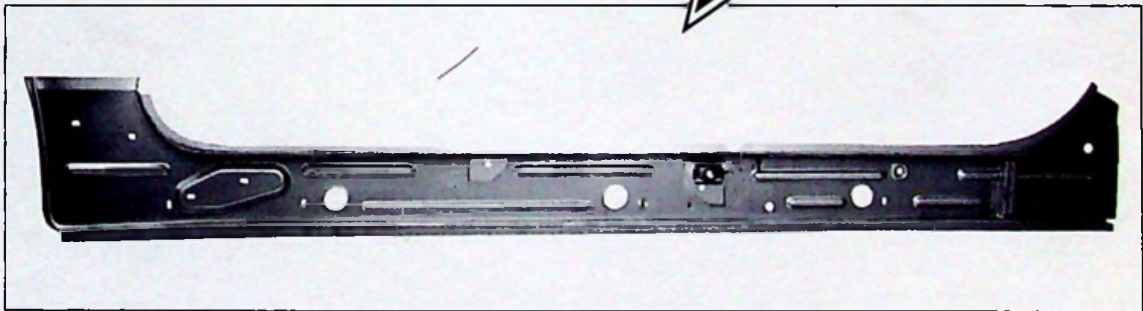

90-1172

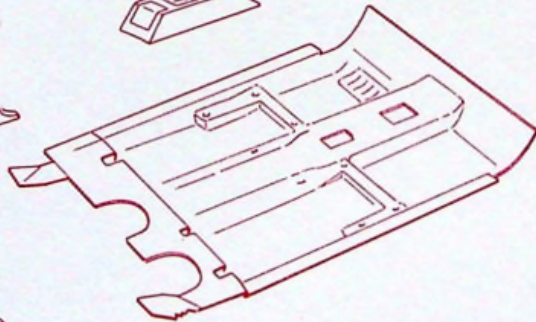
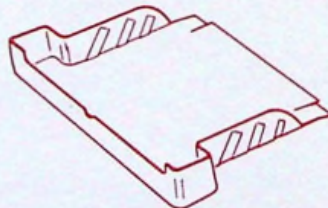
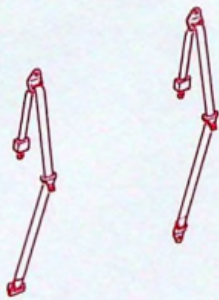
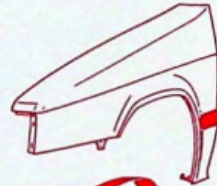
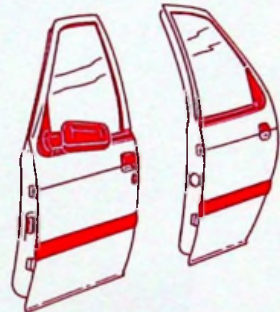
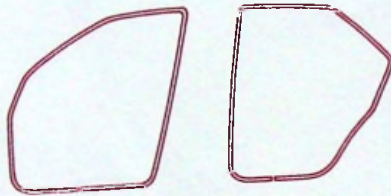
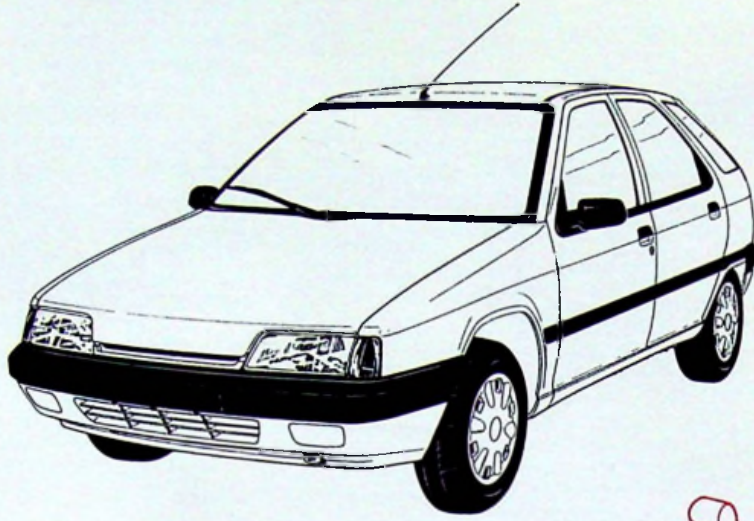
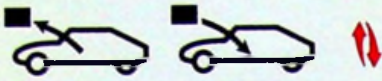

- F. 80-12
- F. 80-20
- F. 80-28
- F. 91-1



14



ZX
821-3/8

3



90-1084

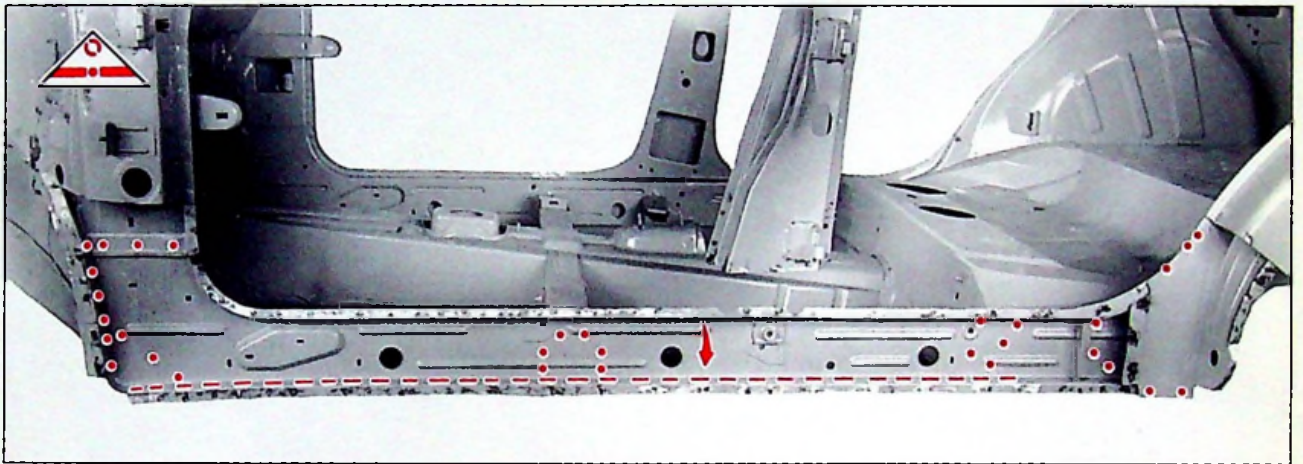

91-619

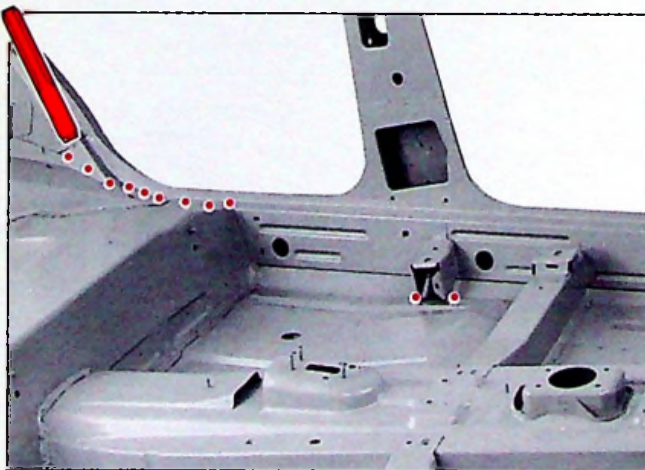
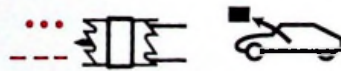

90-1095

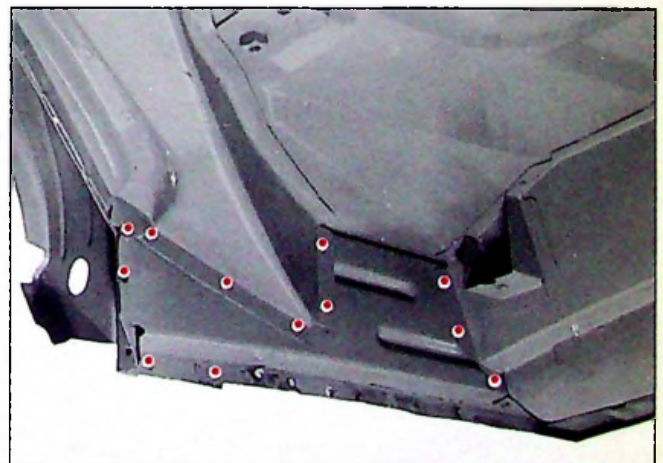

91-622

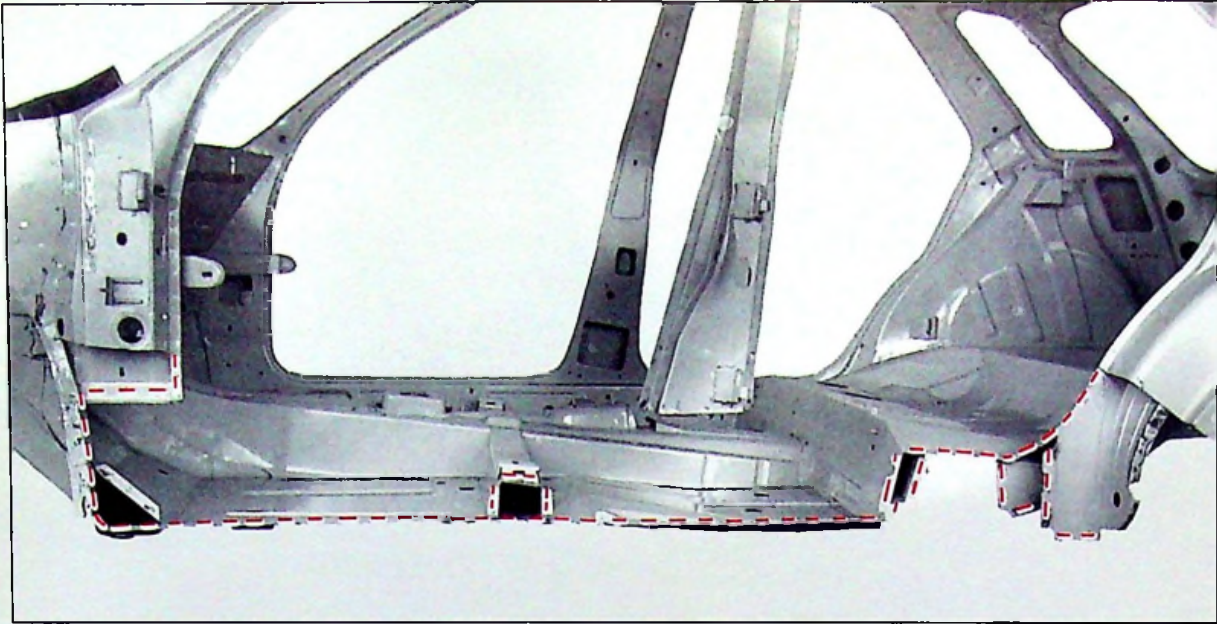

91-623



91-624

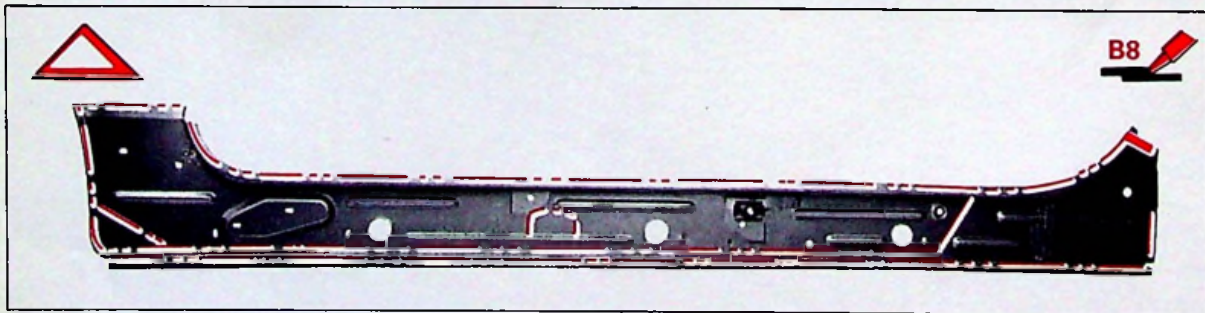

90-1172

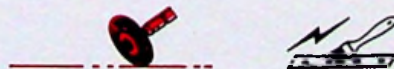



14



ZX
821-3/8

5

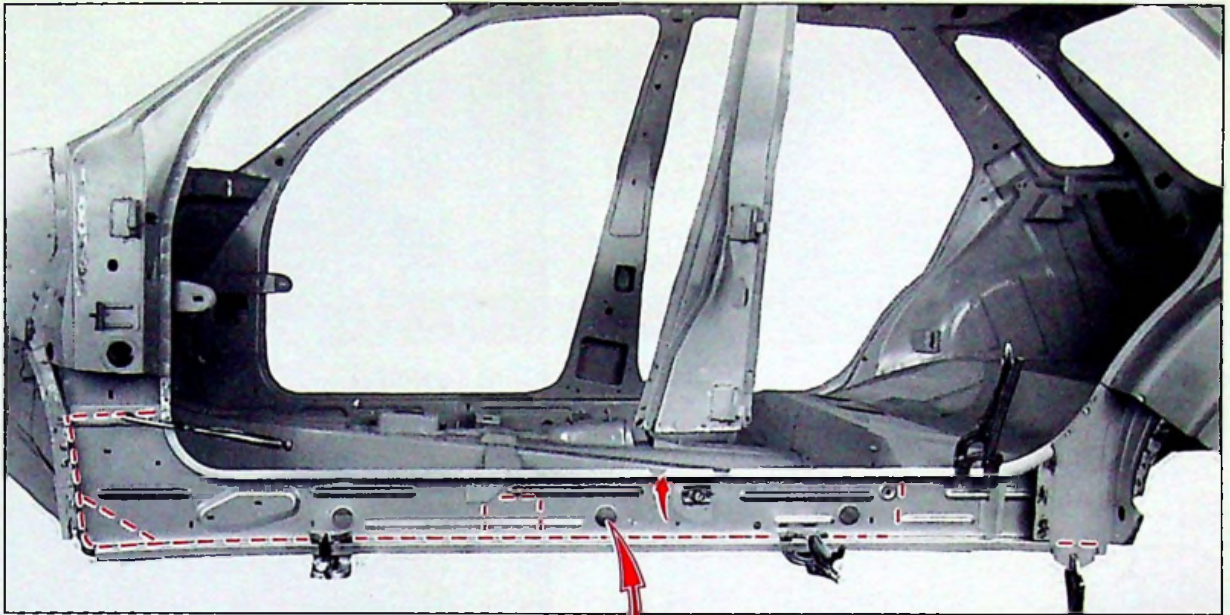

91-625

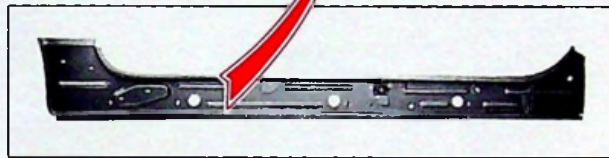

90-1172

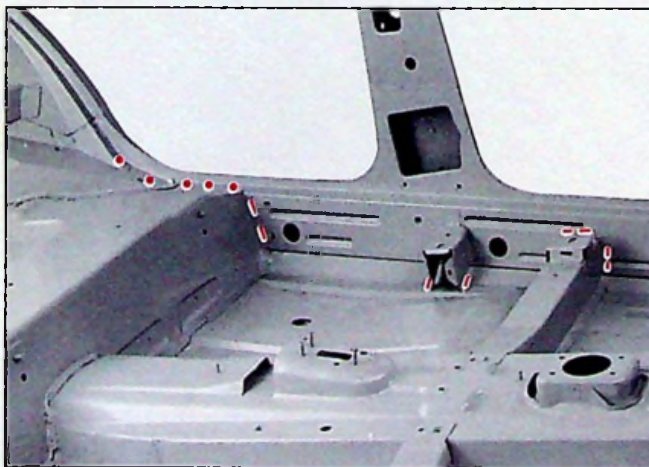

90-1095



91-622

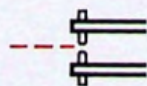



90-1084

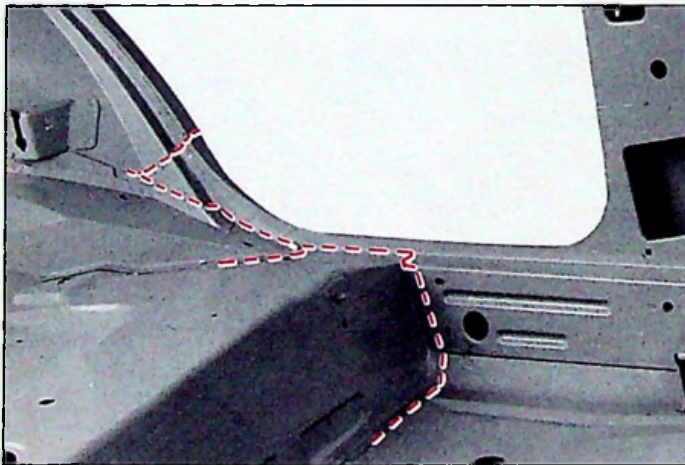

90-1095

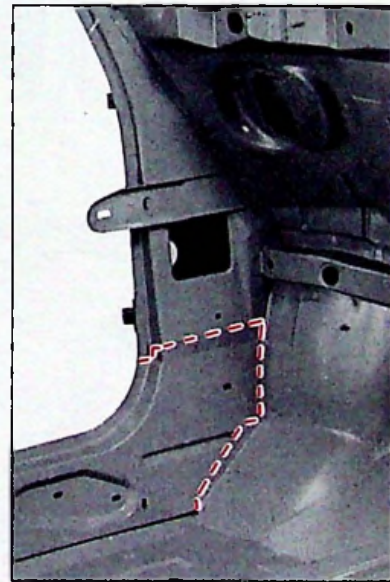

90-1076

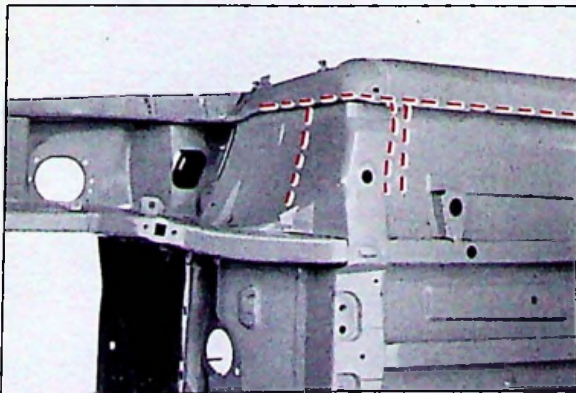

90-1068

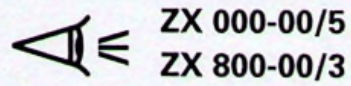



14



ZX
821-3/8

7

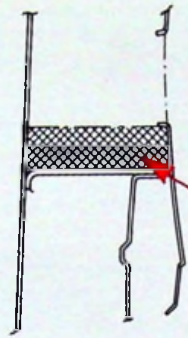

F. 80-4

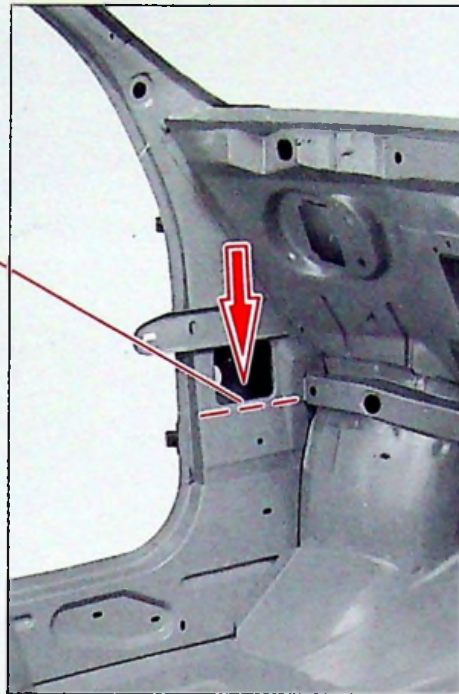

90-1076

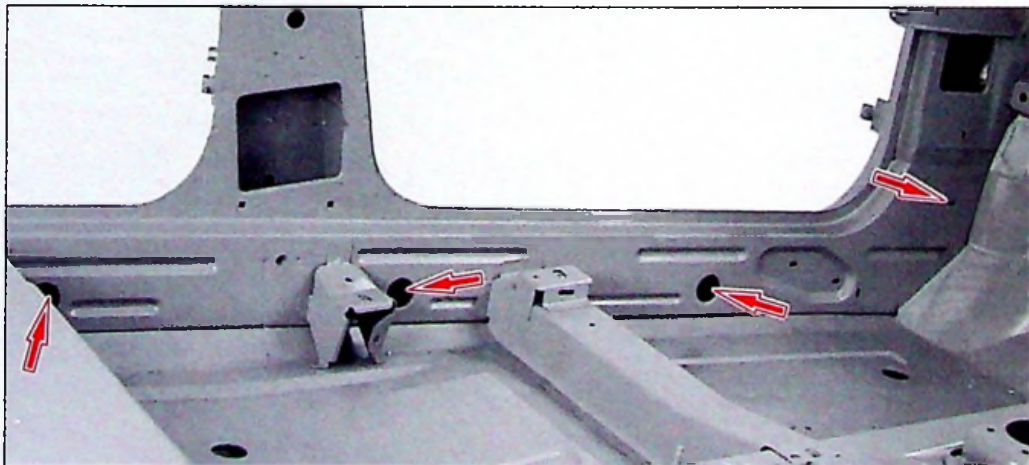
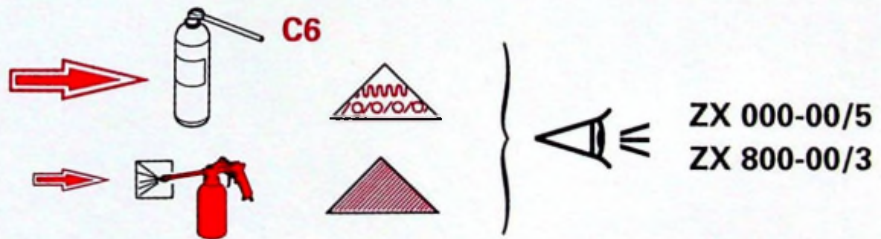

90-1097



14



ZX
822-3/1

1

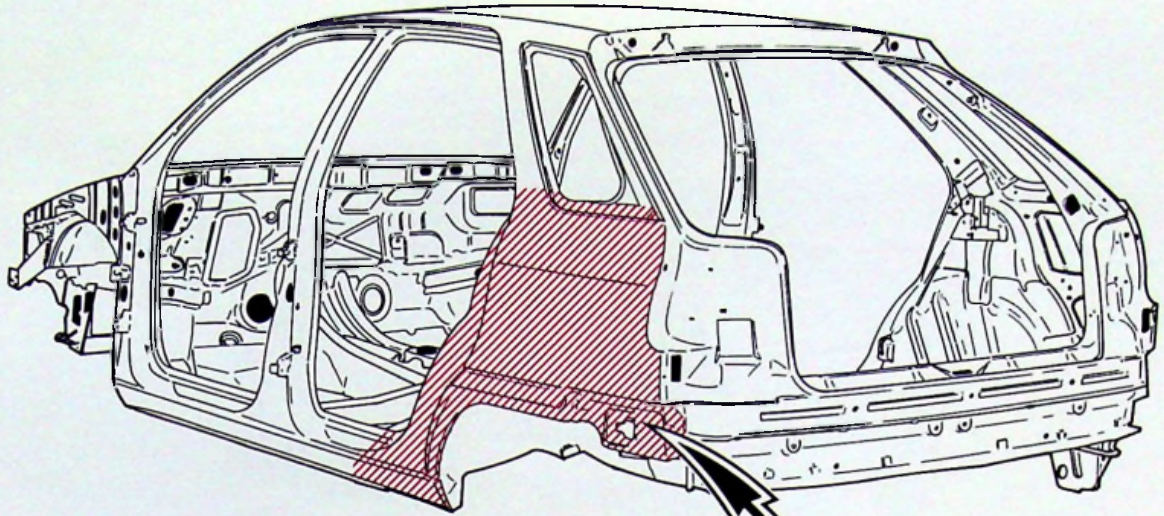

F.80-11

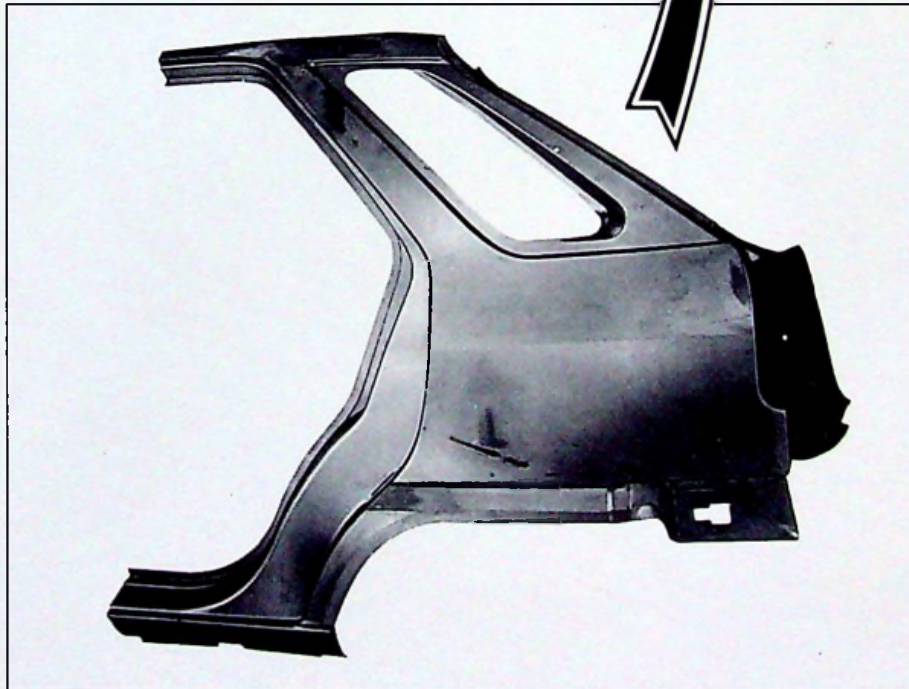

90-1162

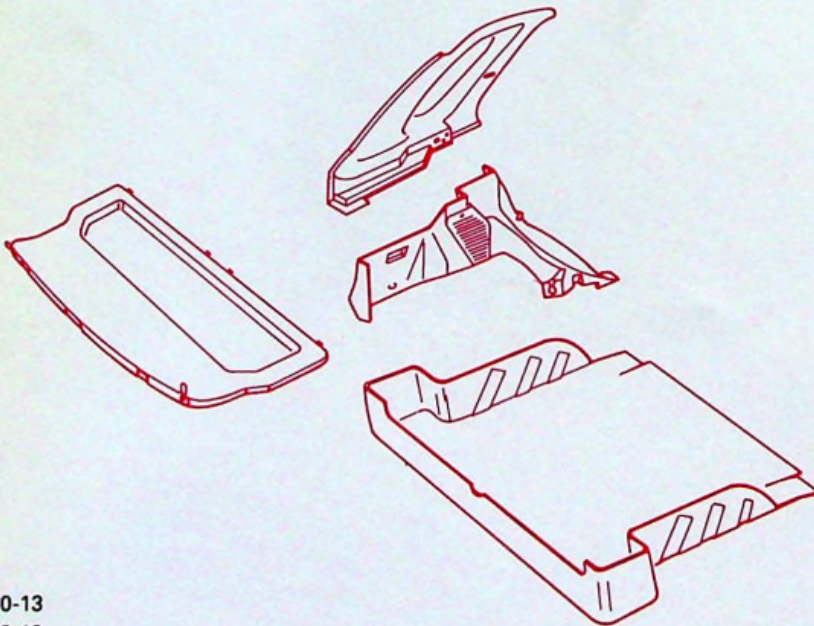
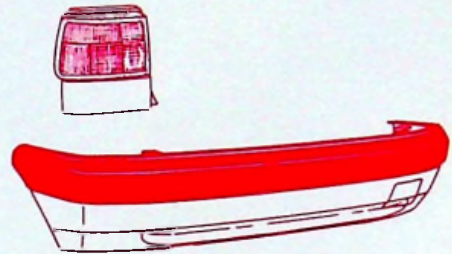
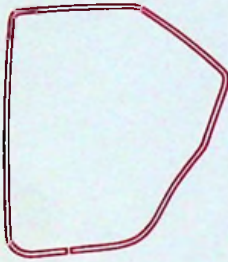
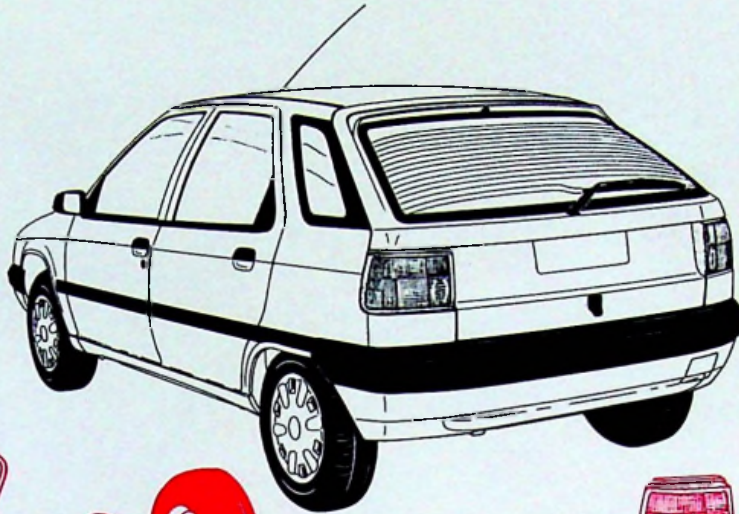
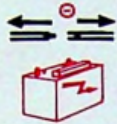
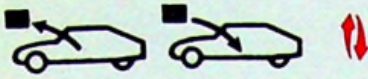

- F. 80-13
- F. 80-19
- F. 80-20
- F. 80-28
- F. 91-1



14



ZX
822-3/1

3

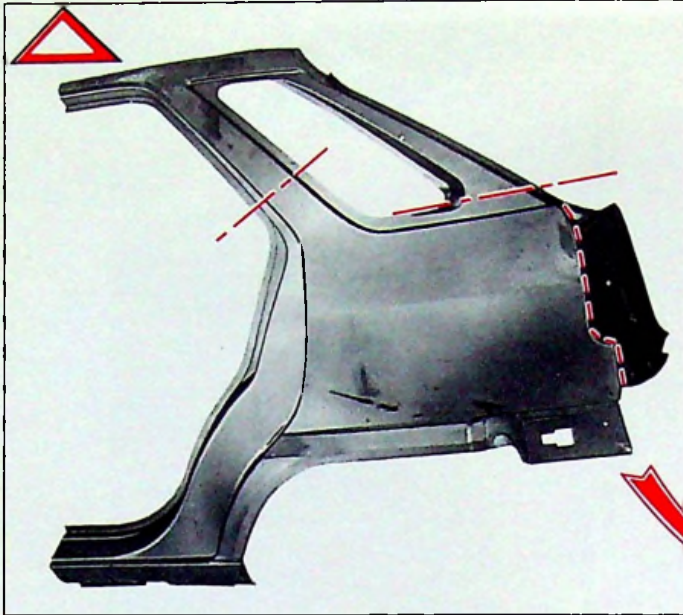

90-1162

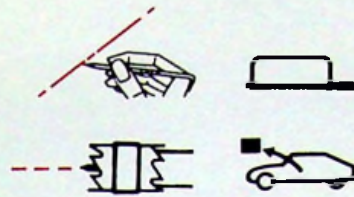

90-1228

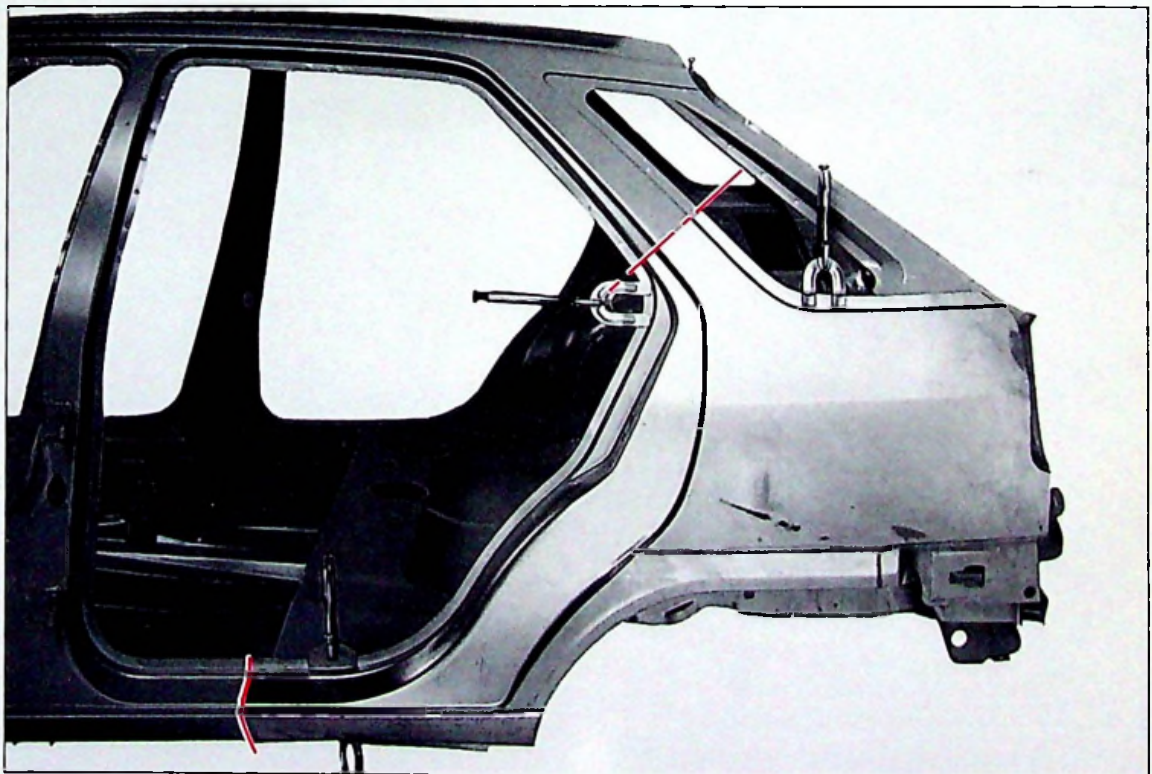

90-1226



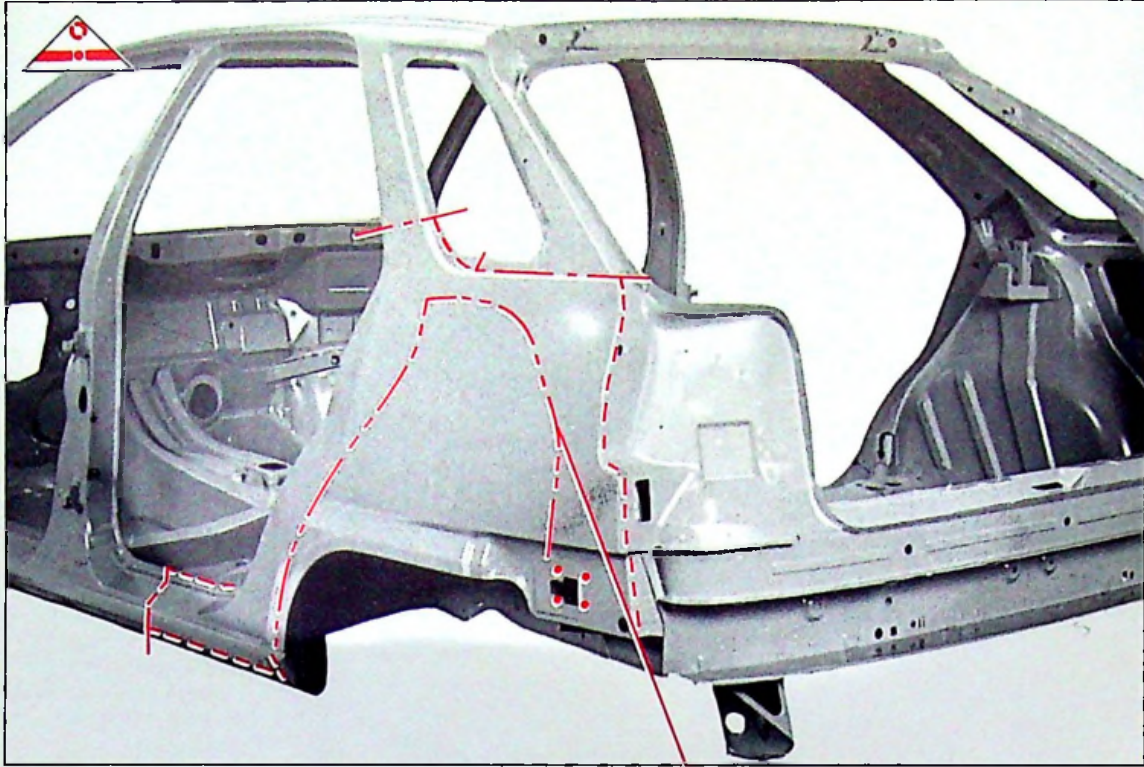

90-963

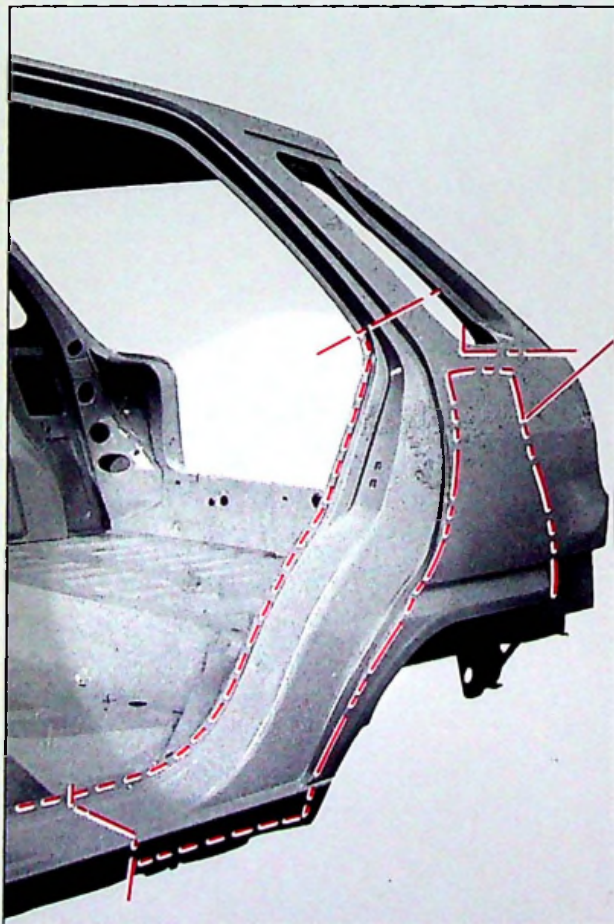

90-1089

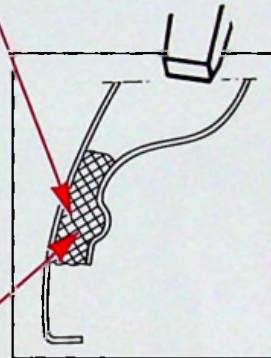

TT.82-5





14



ZX
822-3/1

5



90-1225

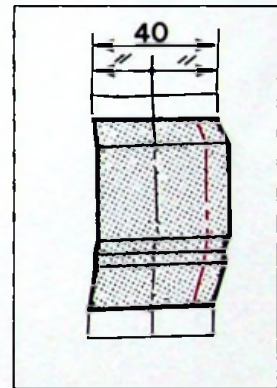

Z.82-2

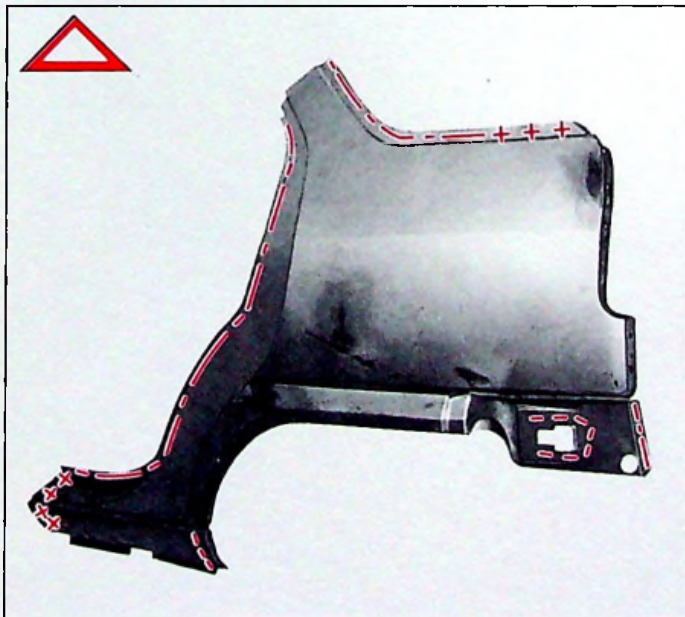

90-1228

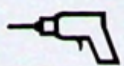
+++  Ø = 6 mm

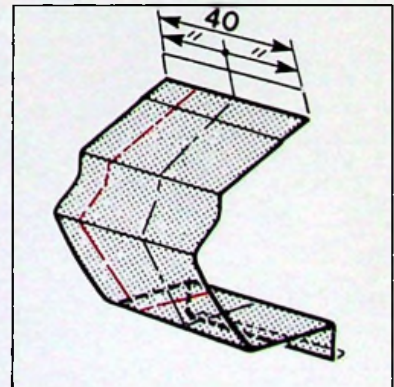

Z.82-2

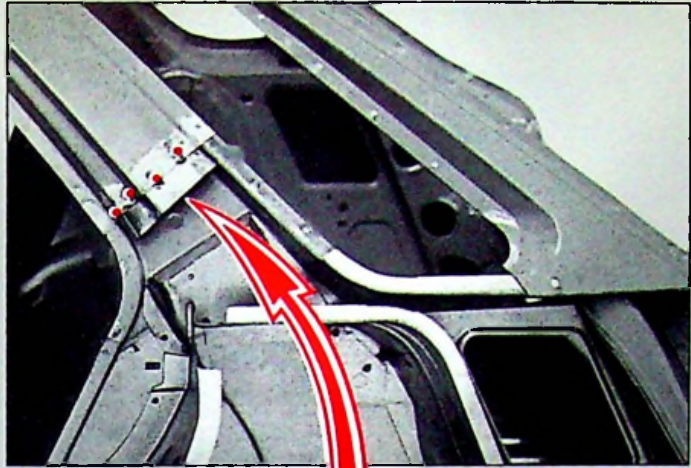
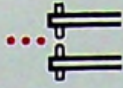

90-1220

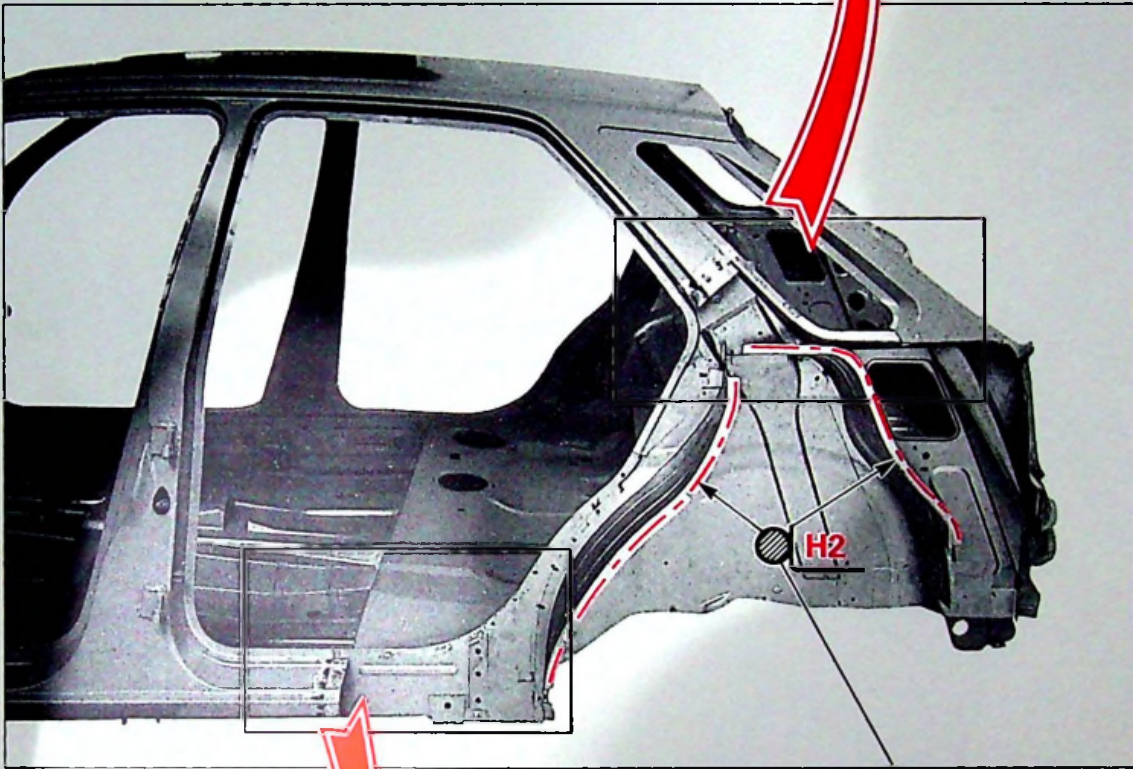
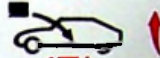

90-1223

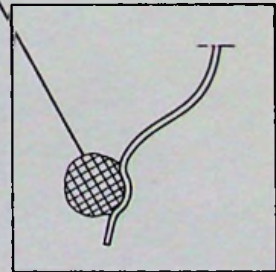

TT.82-5

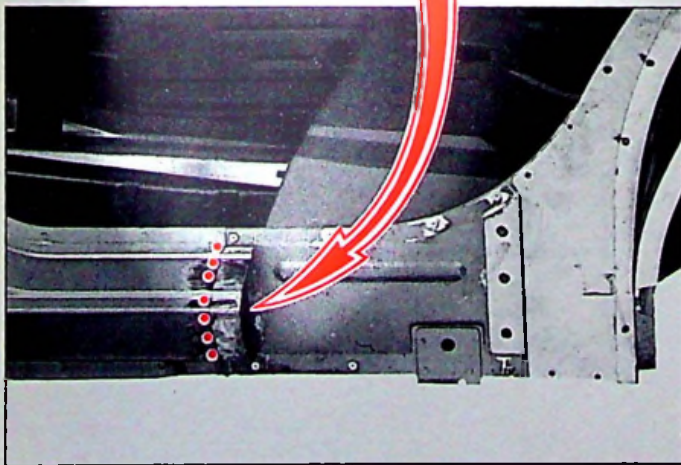

90-1219

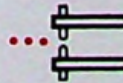

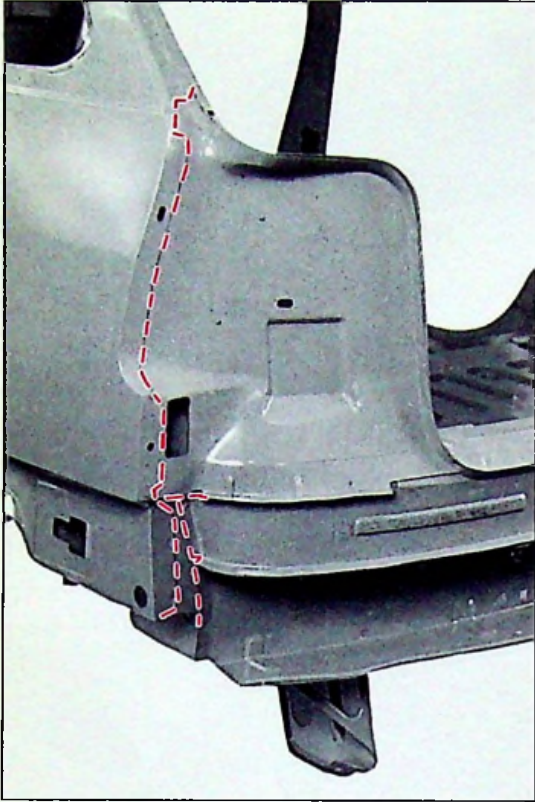
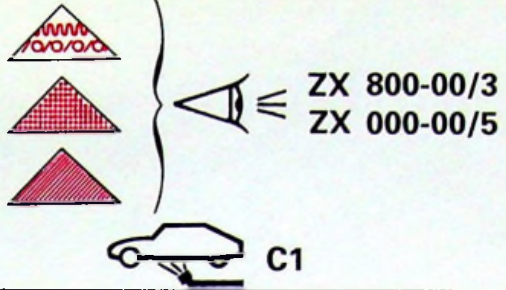

90-964

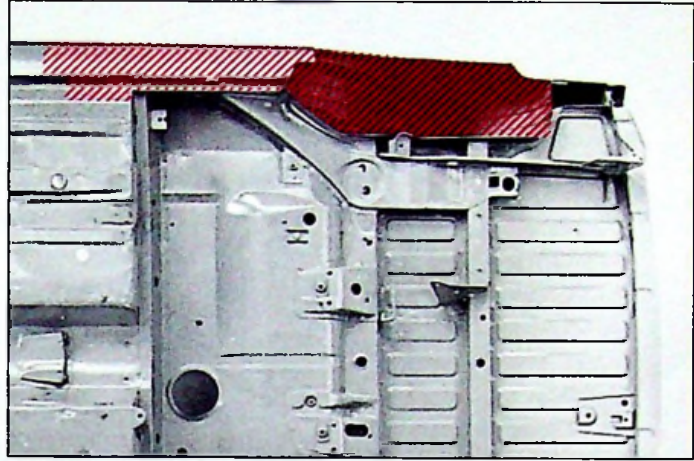

90-1070

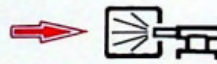

90-1072



90-1098



14



ZX
822-3/2

1

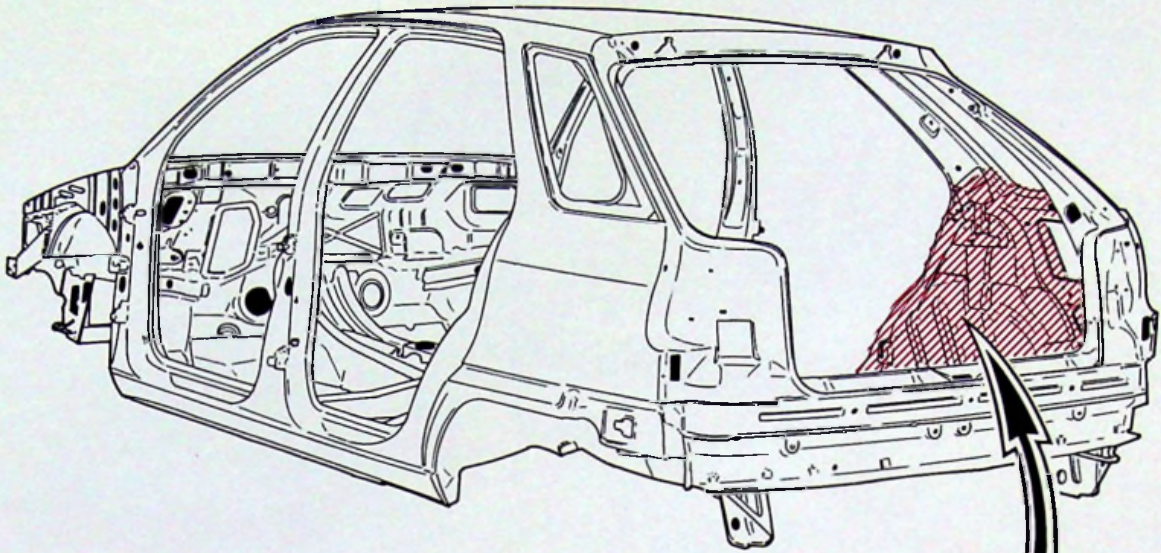

F.80-11

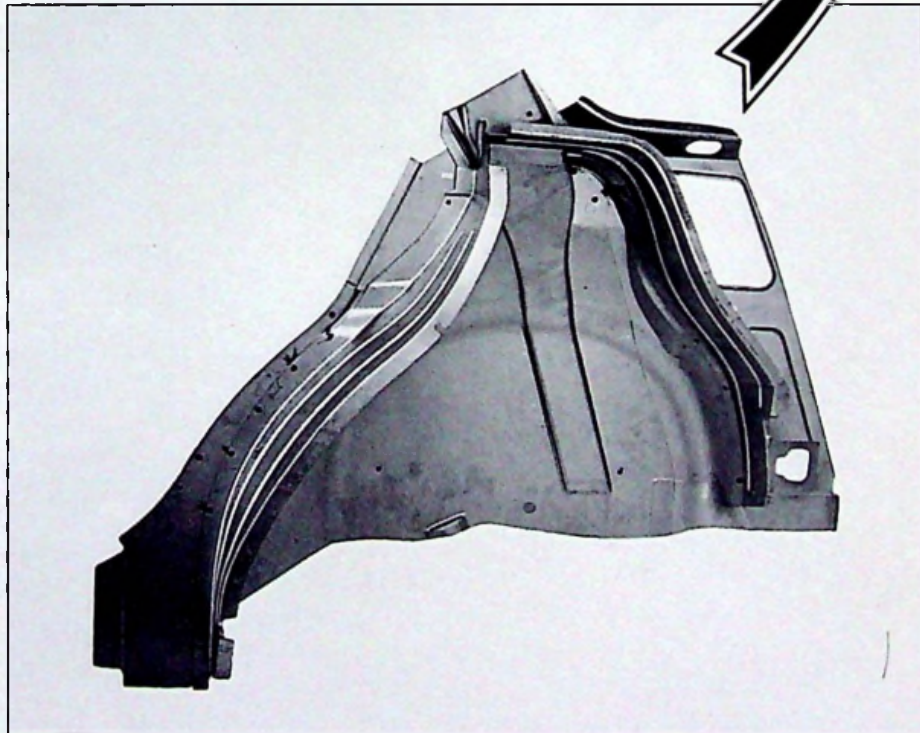

90-1154

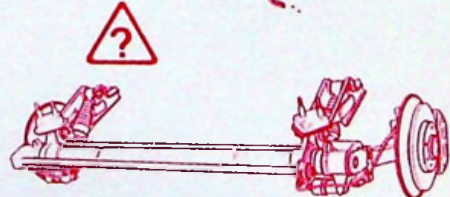
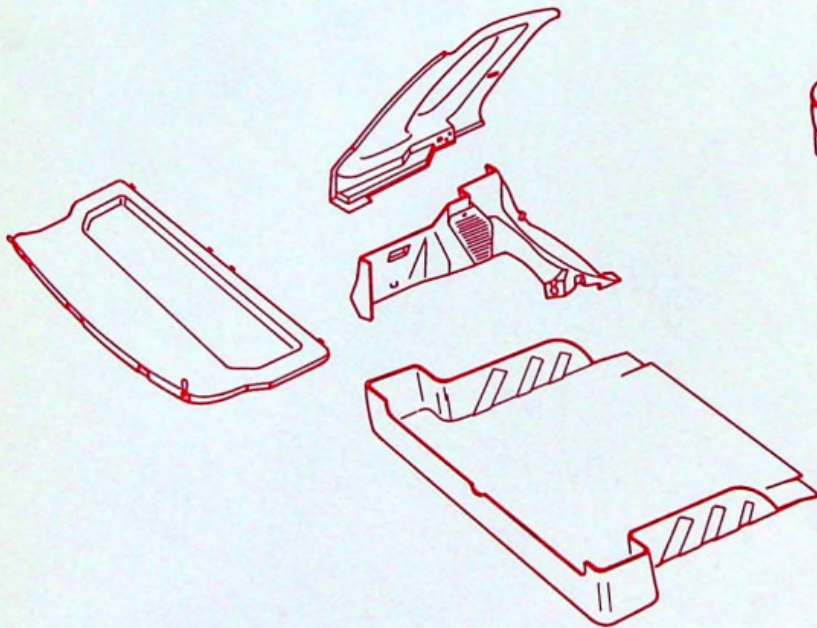
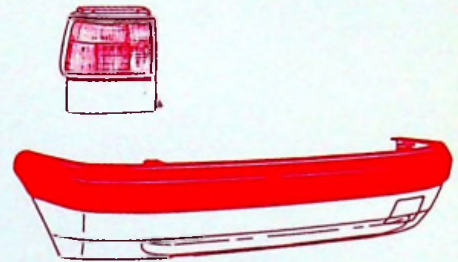
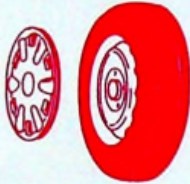
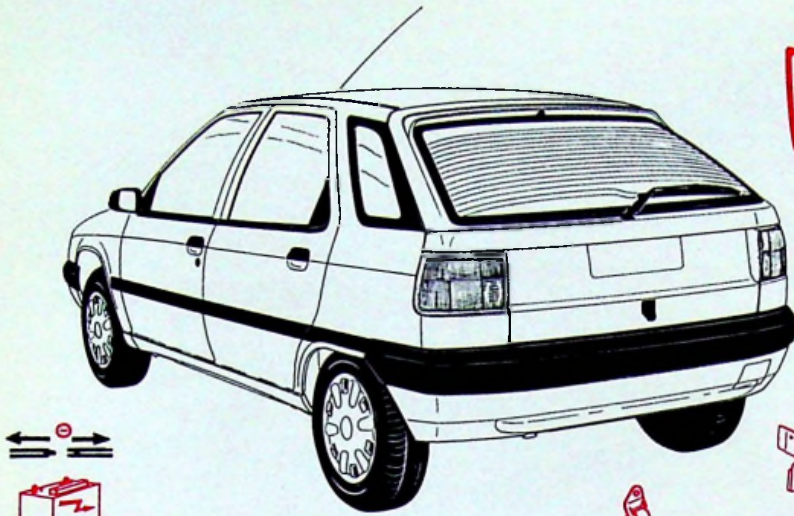

- F. 17-2
- F. 42-5
- F. 80-13
- F. 80-19
- F. 80-20
- F. 80-28
- F. 91-1



14



ZX
822-3/2

3

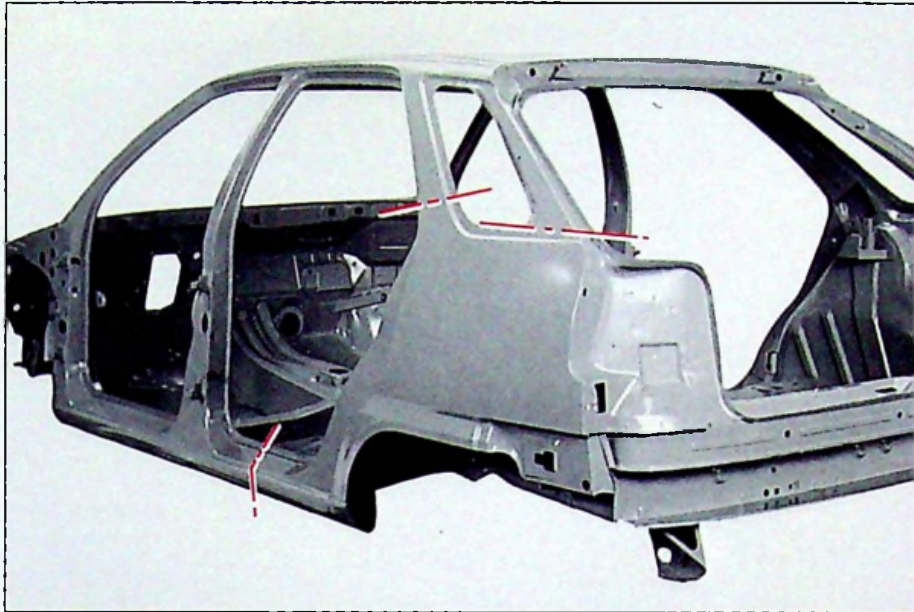

90-963

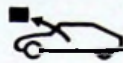

ZX 822-3/1

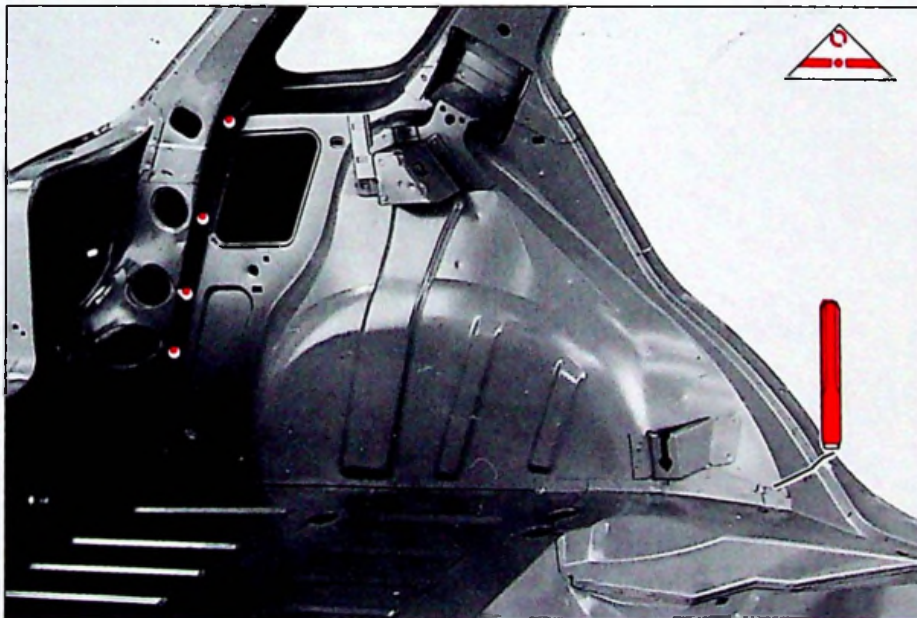

90-1099



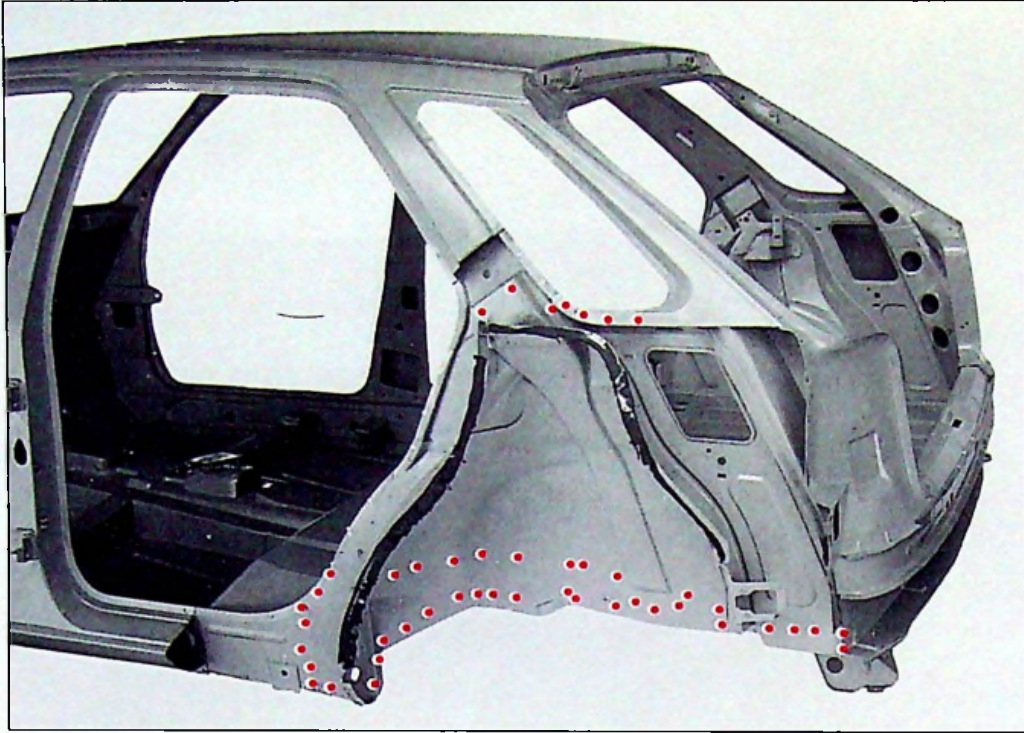

90-1225

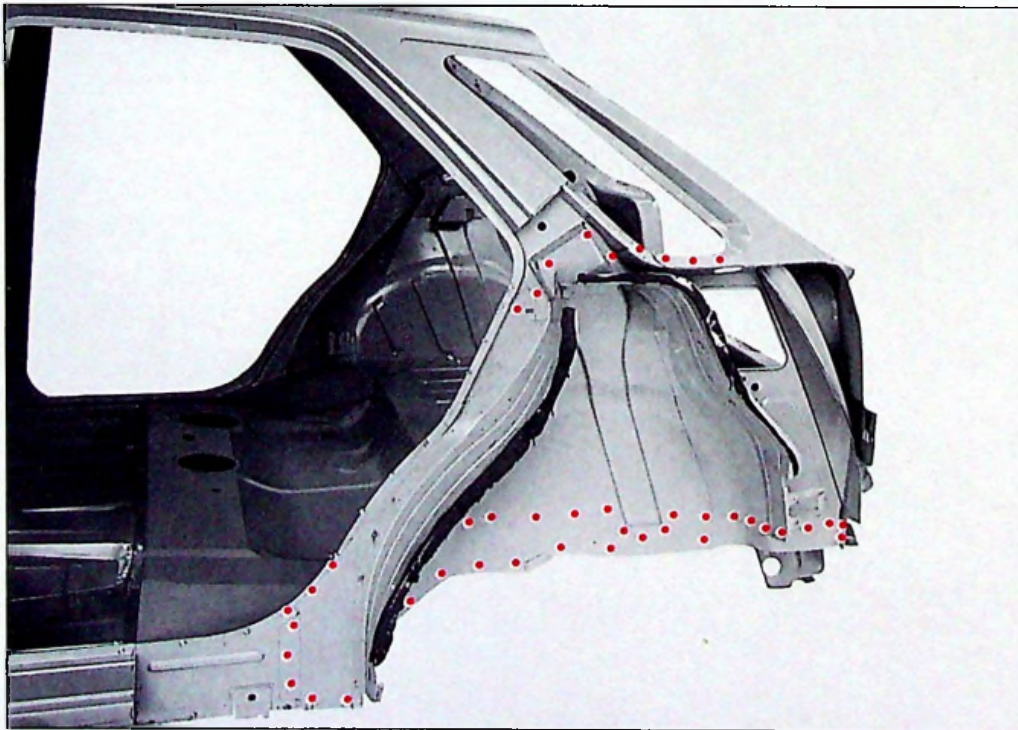

90-1224



14



ZX
822-3/2

5

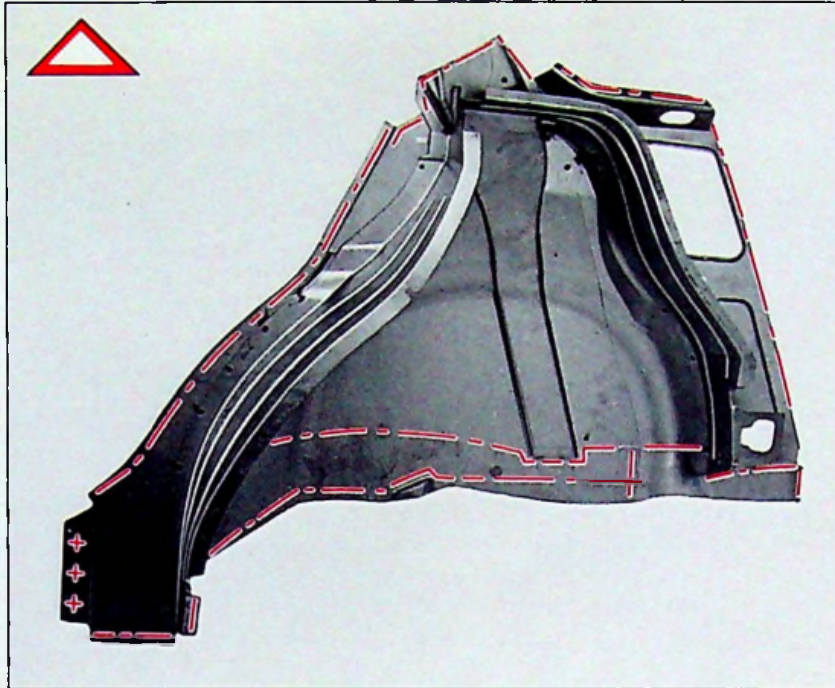

90-1154



+++  Ø = 6 mm

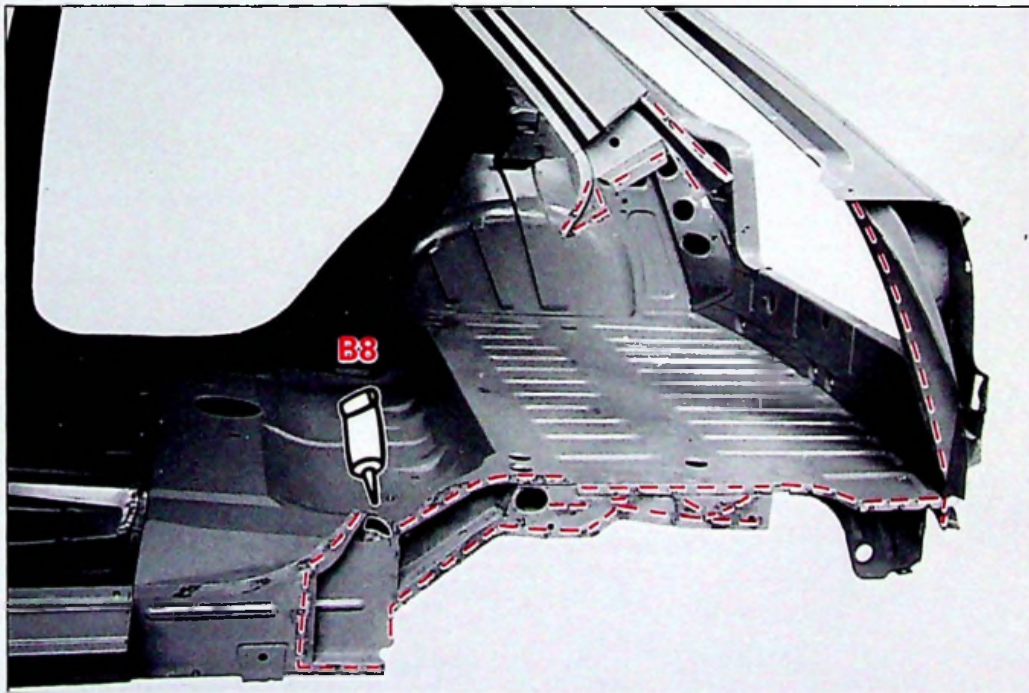

90-1218



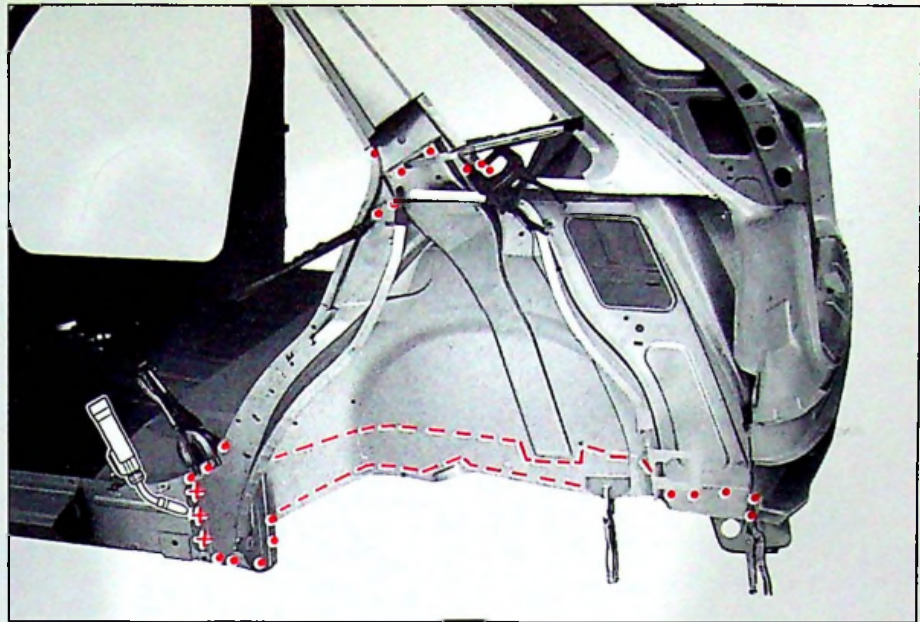
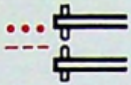

90-1221

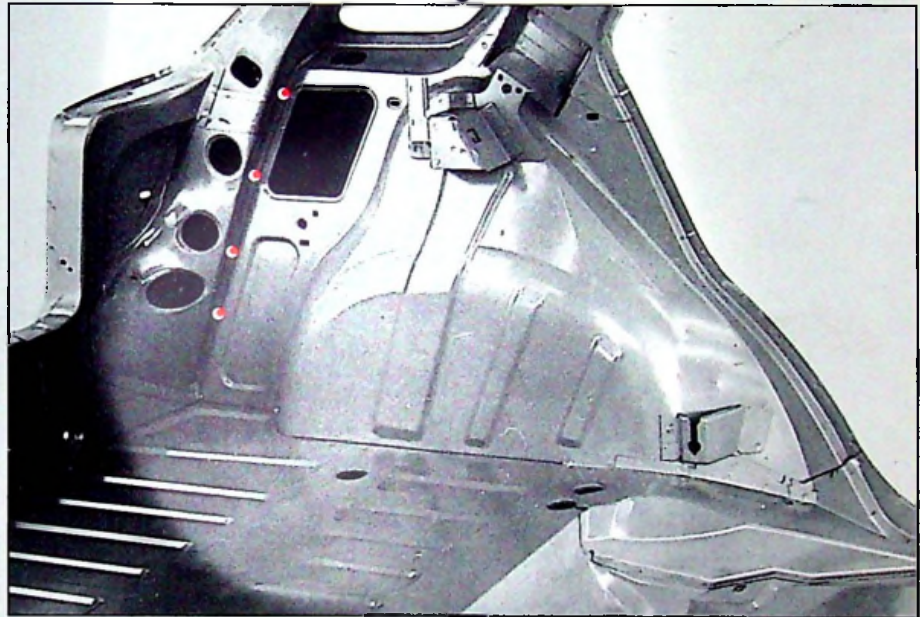

90-1099

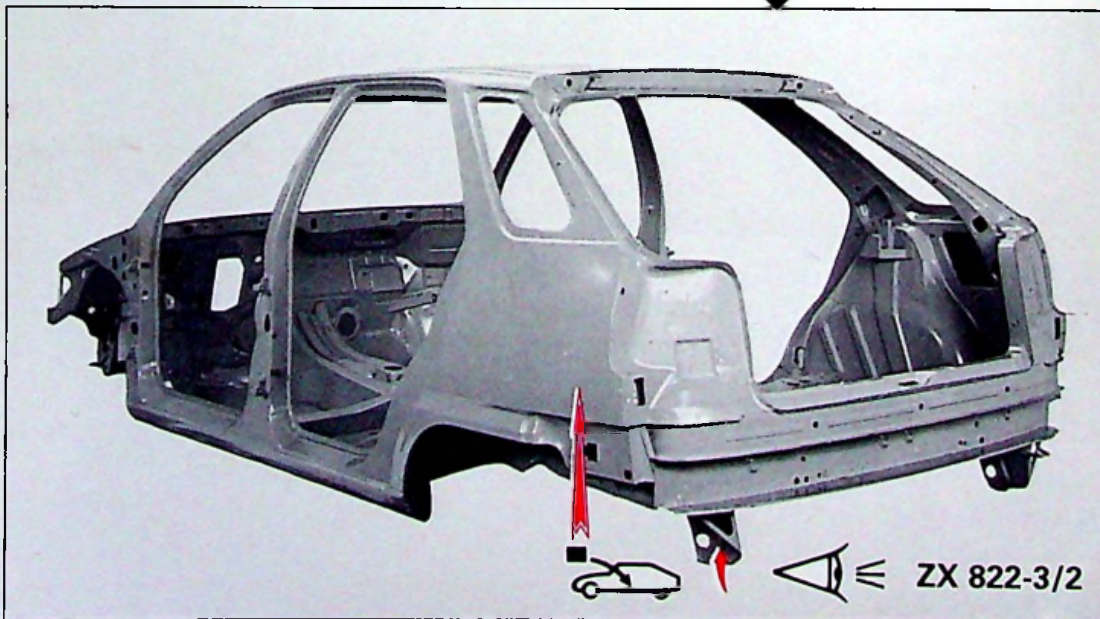

ZX 822-3/2

90-963



14



ZX
822-3/2

7

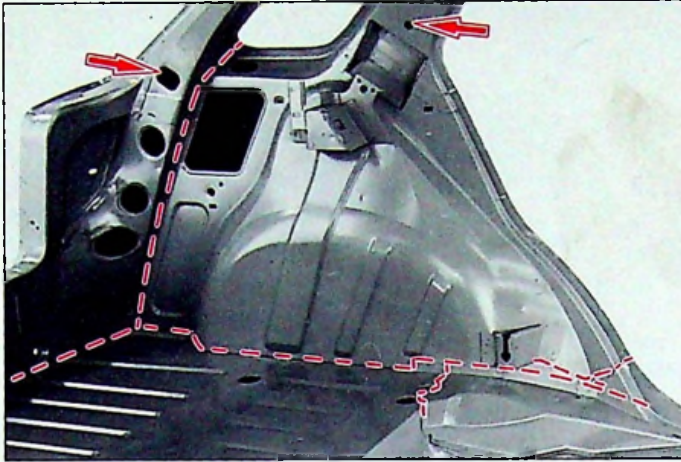
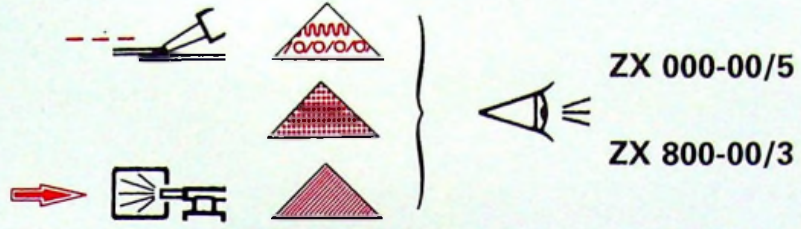

90-1099

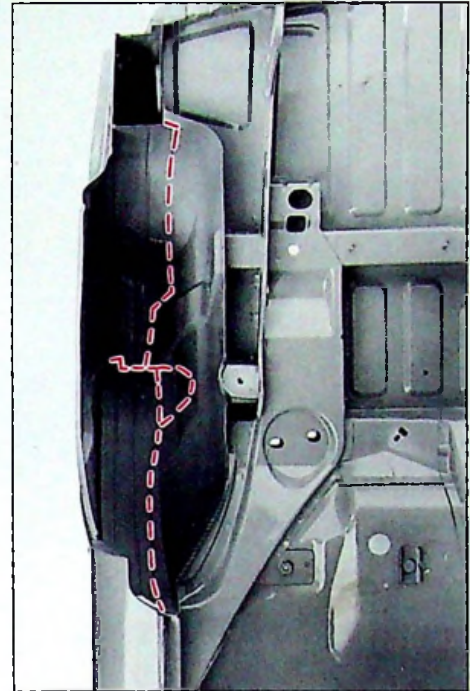

90-1064



90-1072

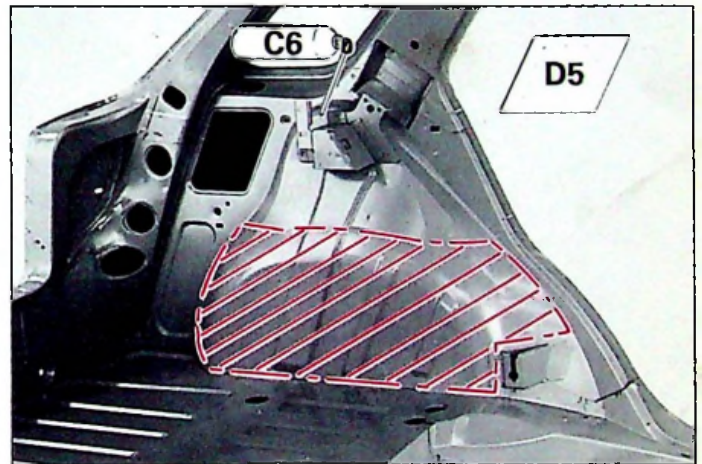

90-1099

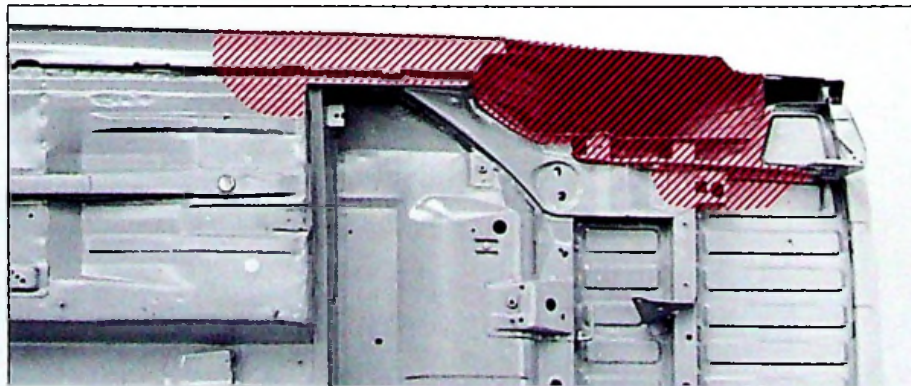

90-1070



14



ZX
823-3/1

1

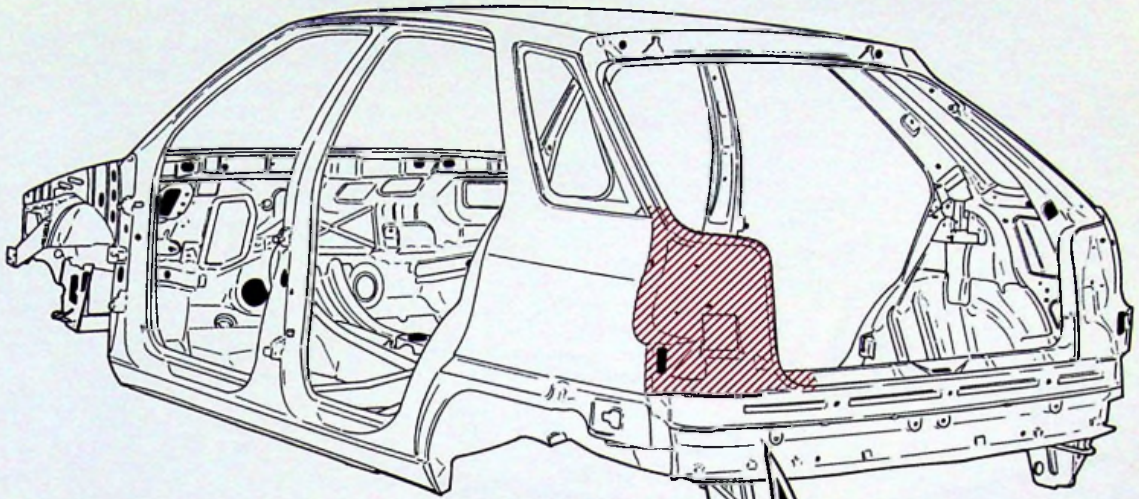

F.80-11



90-1152

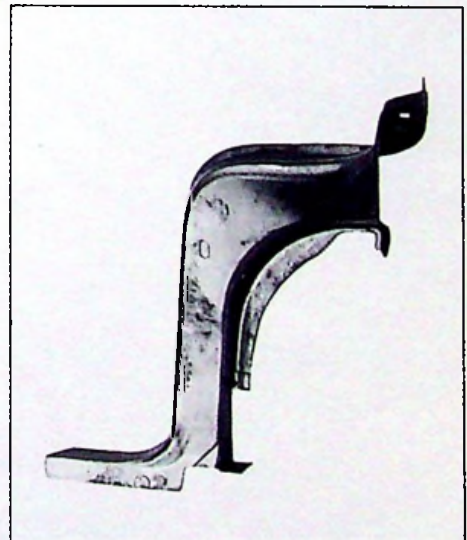

90-1151

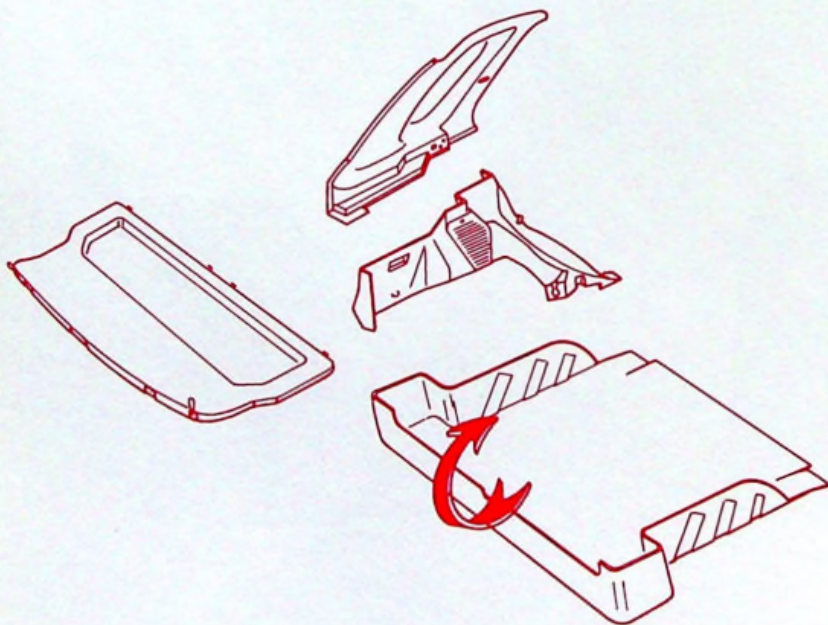
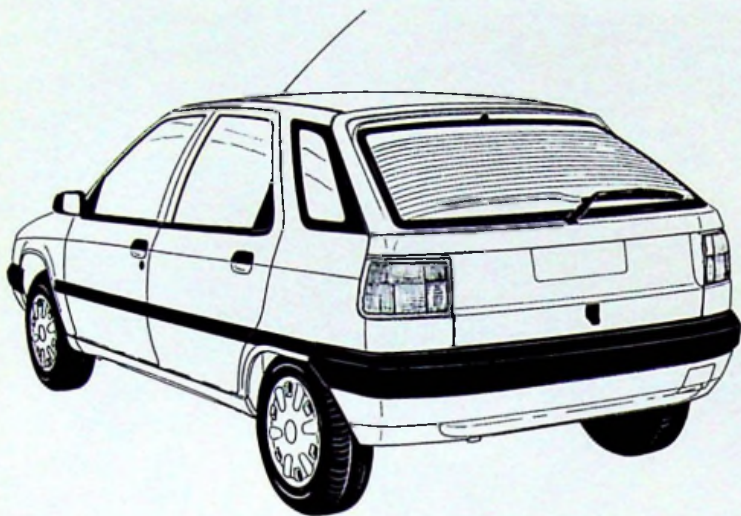
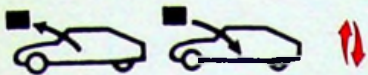

- F. 80-20
- F. 80-13
- F. 80-19
- F. 80-28



14



ZX
823-3/1

3

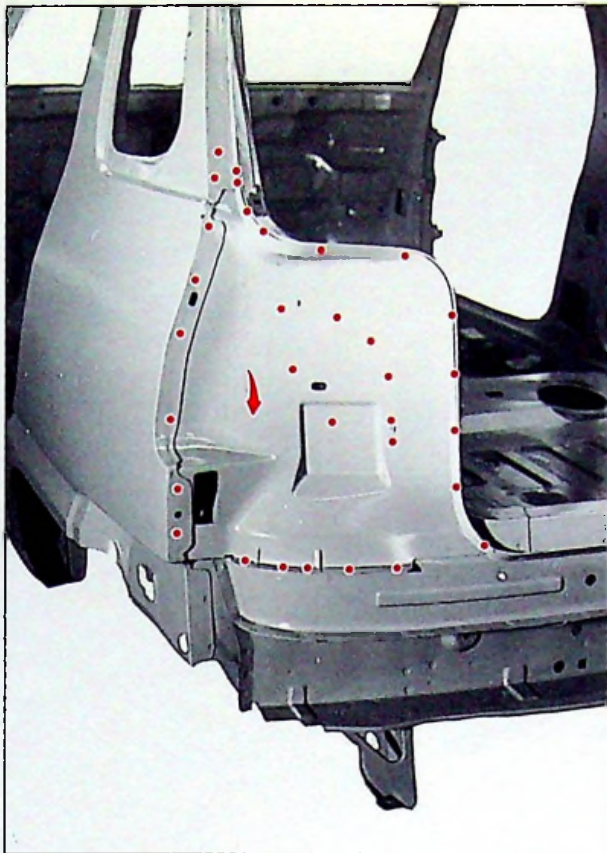

91-304

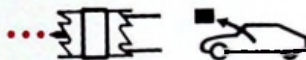

91-303



90-1098

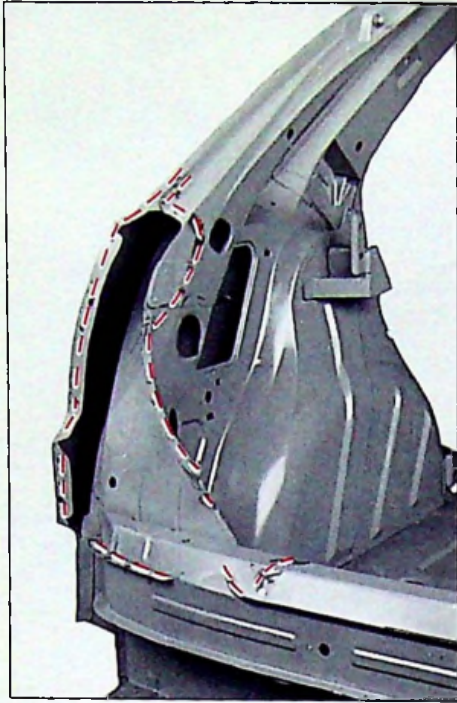

91-302

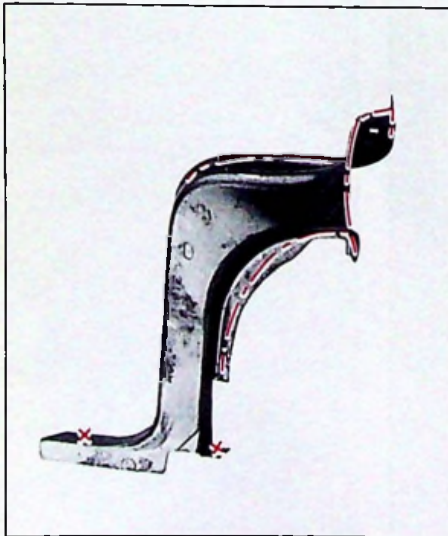

90-1151



90-1152

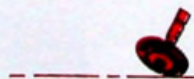

+++  Ø = 6 mm



14



ZX
823-3/1

5



91-301



91-300



91-299





90-964

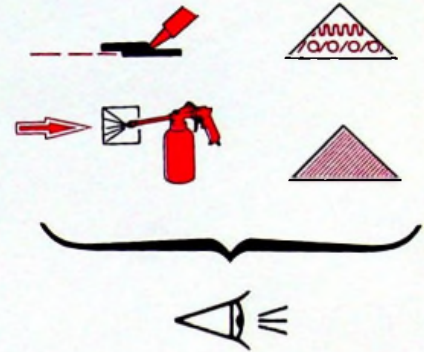

ZX 000-00/5
ZX 800-00/3

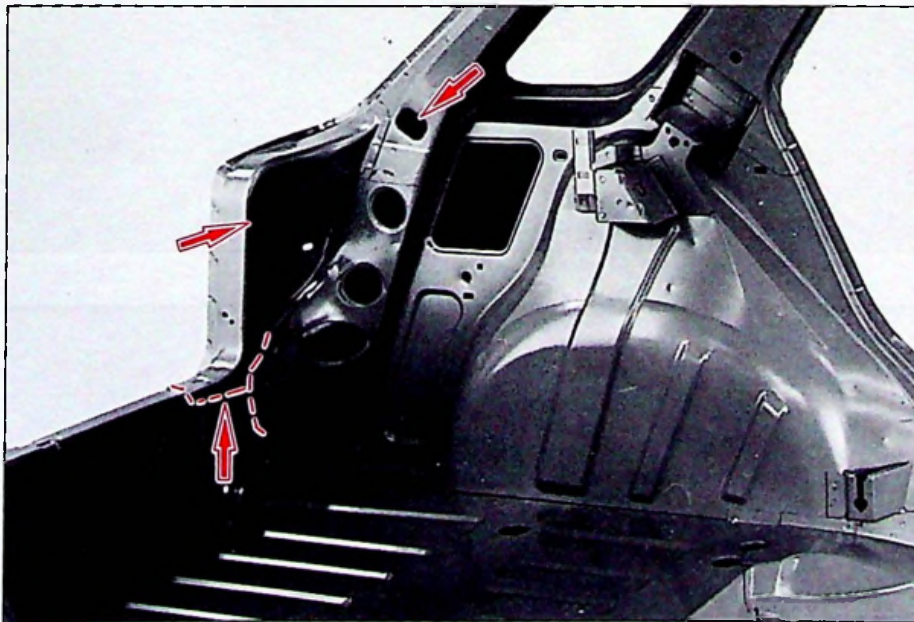

90-1099



14



ZX
823-3/2

1

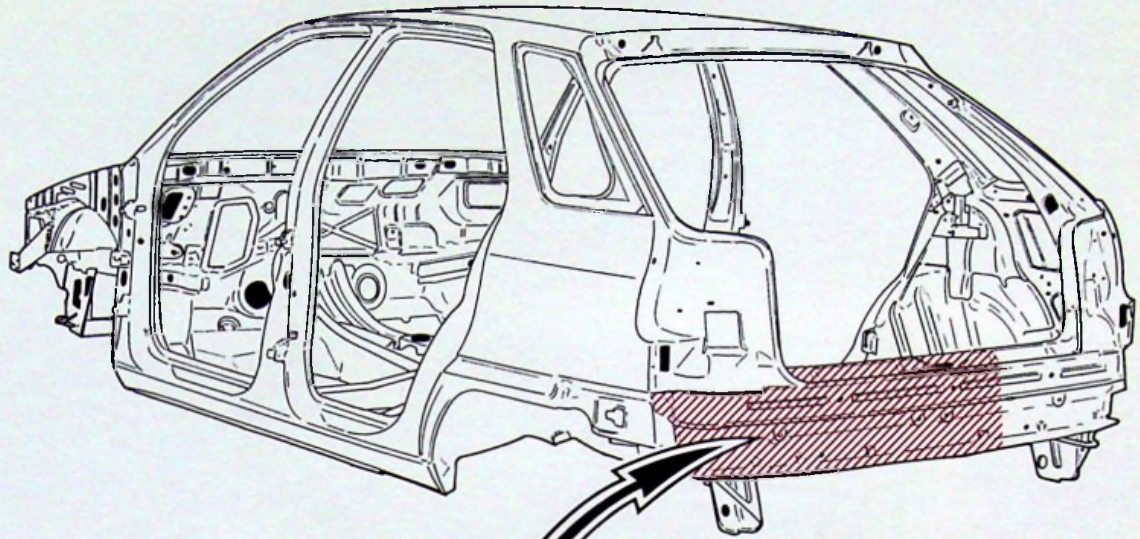

F.80-11

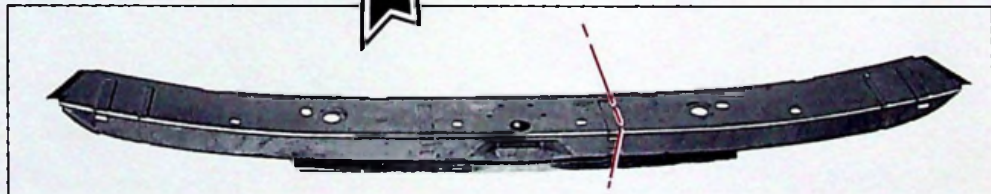

90-1140

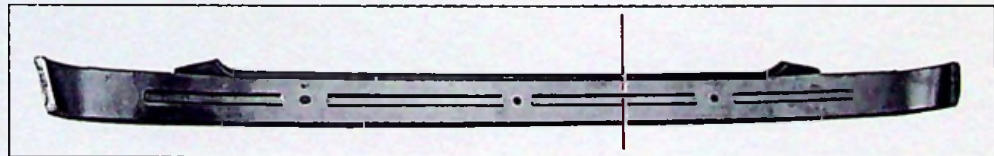

90-1141

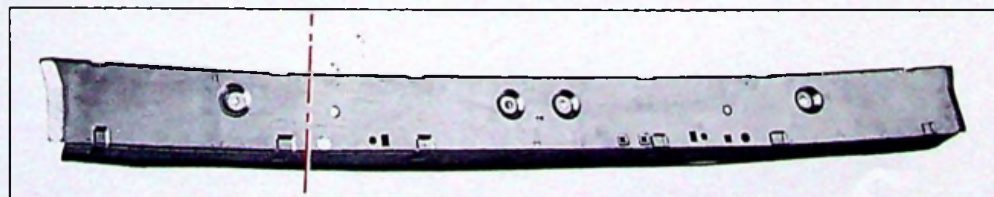

90-1142

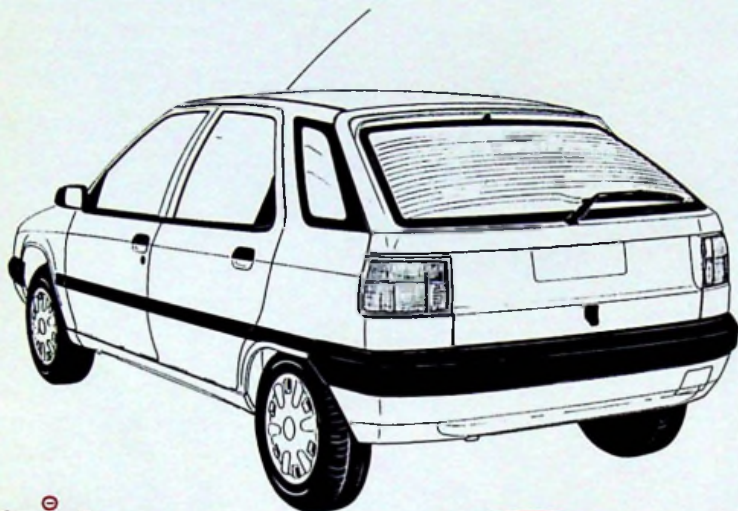
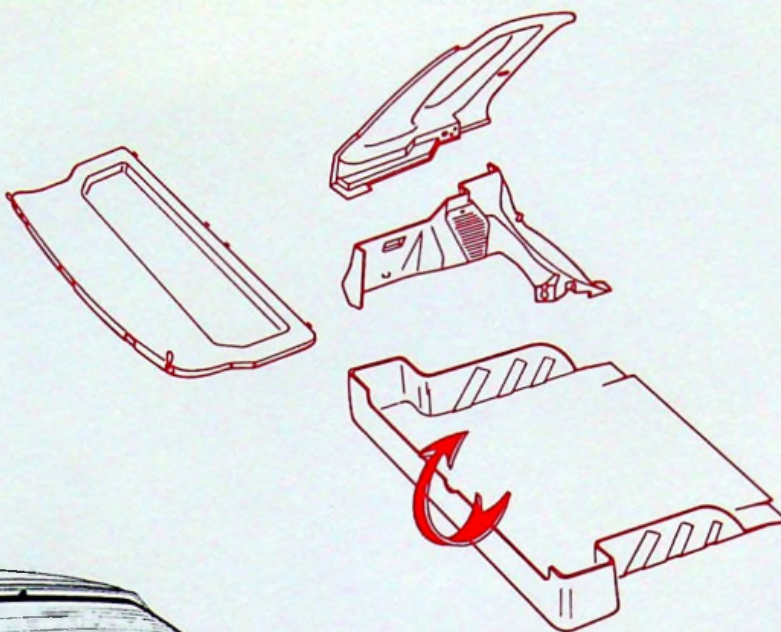
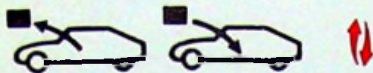

- F. 80-13
- F. 80-19
- F. 80-20
- F. 80-28



14



ZX
823-3/2

3

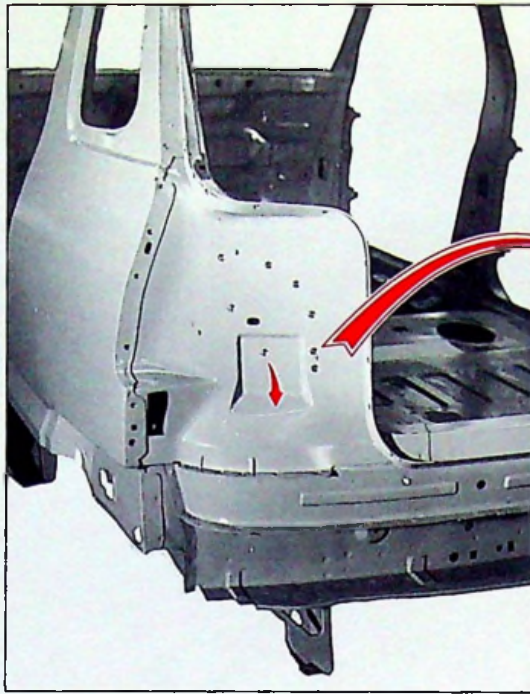

91-304

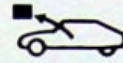

ZX 823-3/1

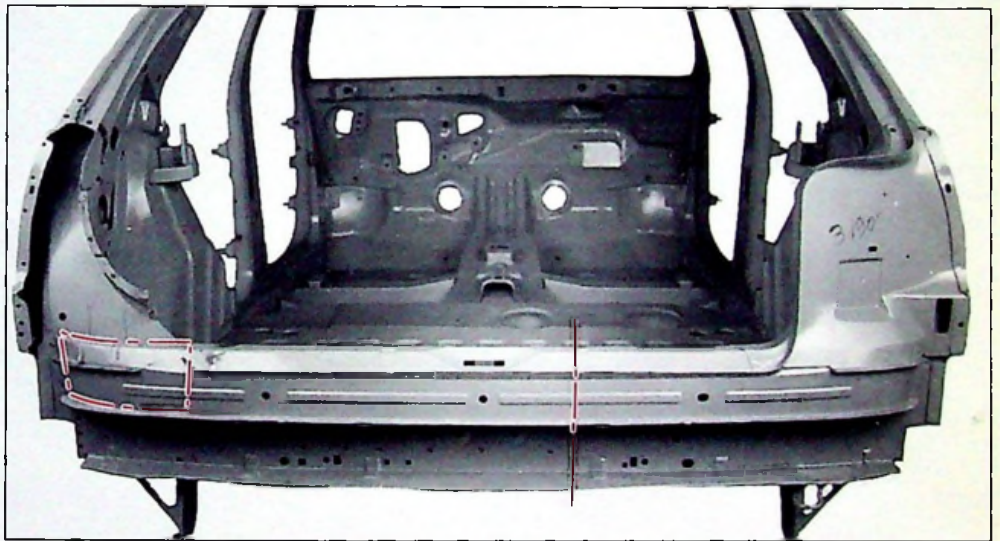

91-297

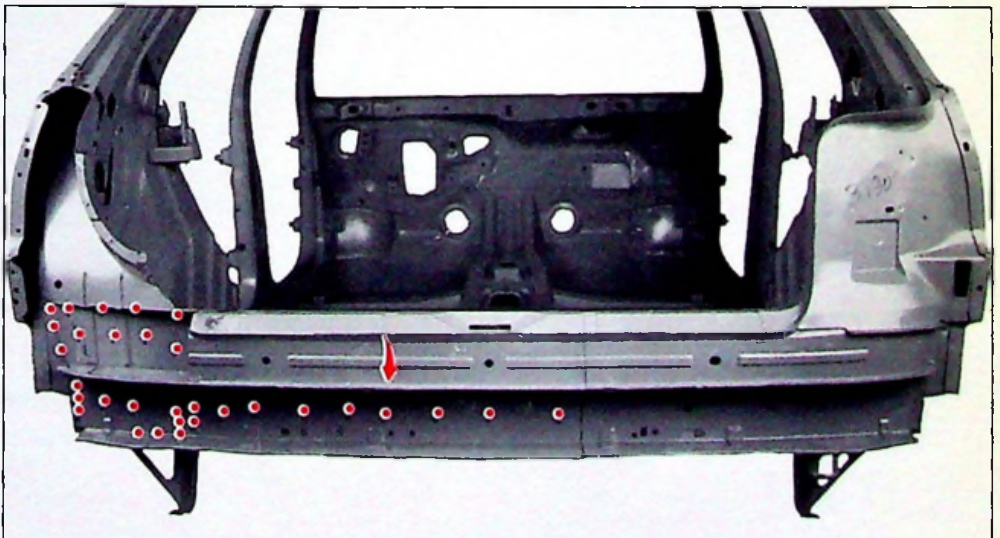
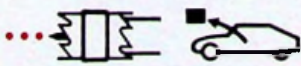

91-296

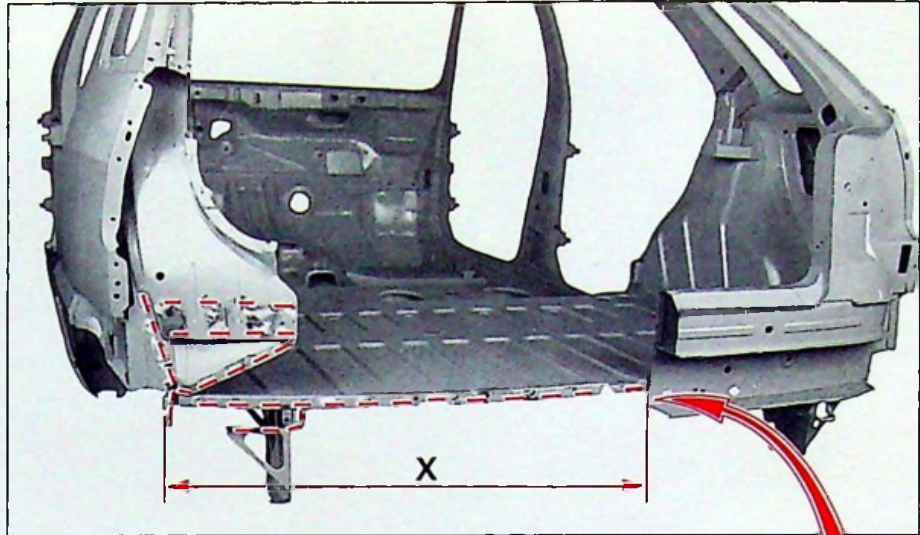

91-295

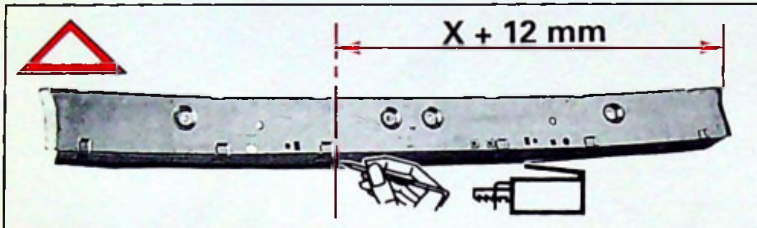

90-1142



91-330

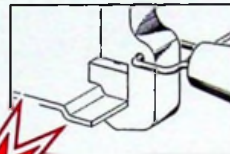

TT. 80-17



TT. 80-17

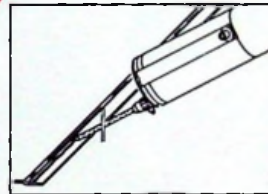

TT. 80-24

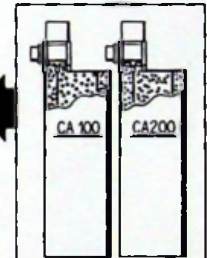

ZCP. 830-129 A

TT. 80-23



TT. 80-24

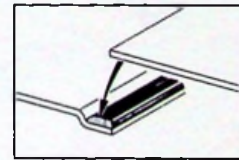

TT. 80-17

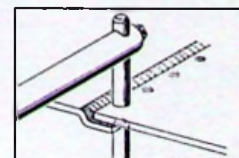

TT. 80-17

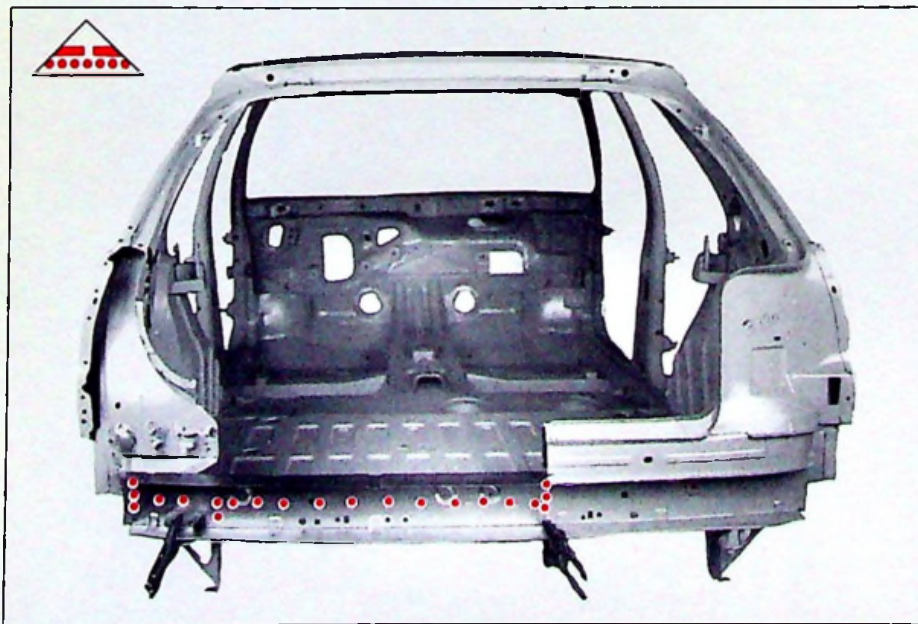
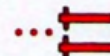

91-332



14



ZX
823-3/2

5

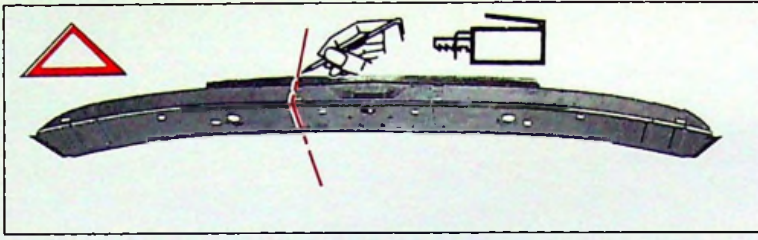

90-1140

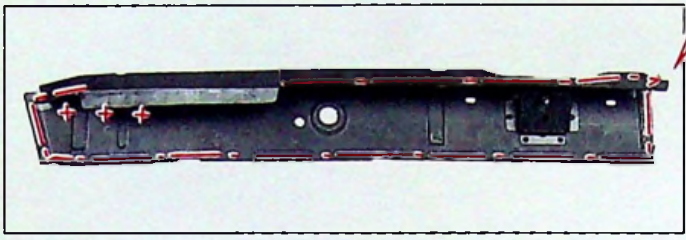

91-329



TT. 80-17

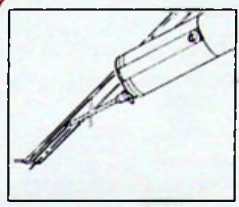

TT. 80-24

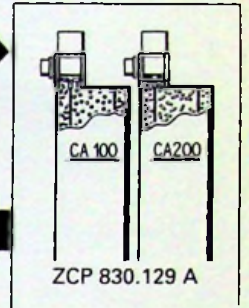

ZCP 830.129 A

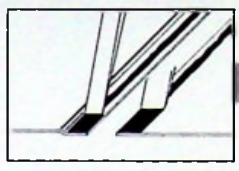

TT. 80-24

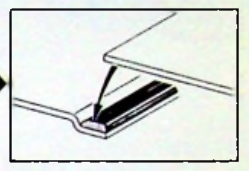

TT. 80-17

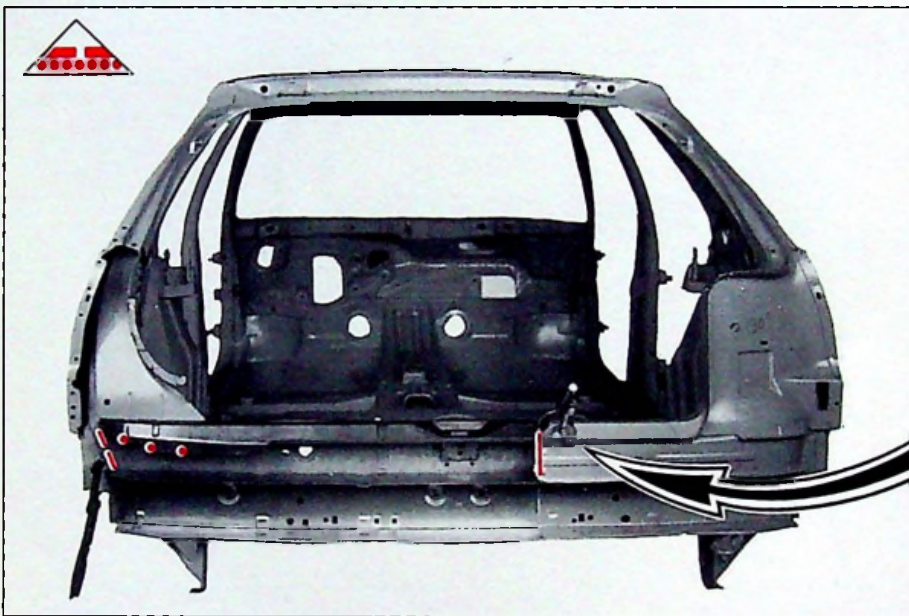

91-333

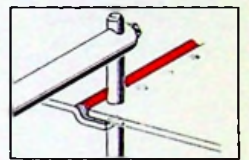

TT. 80-17

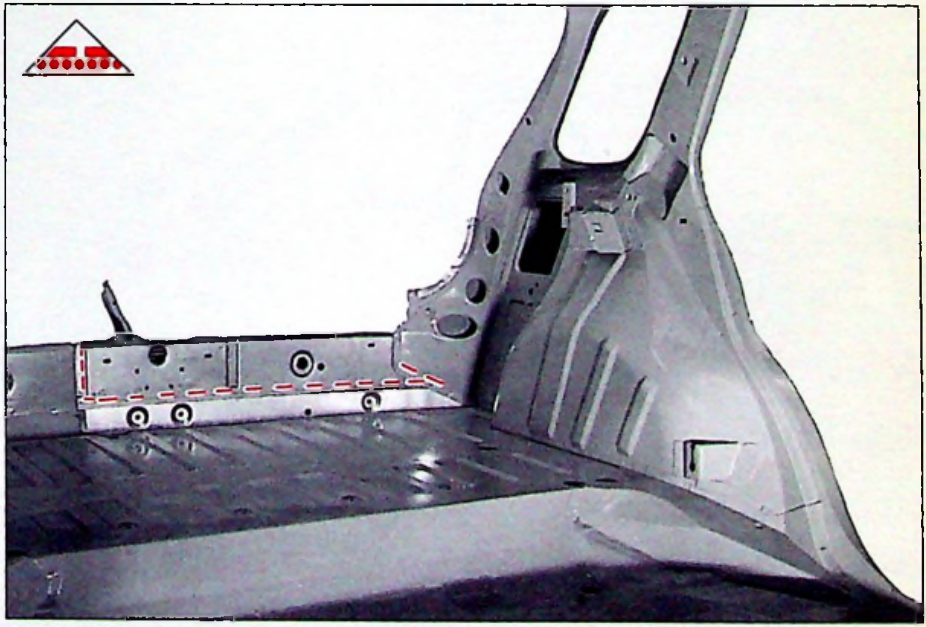
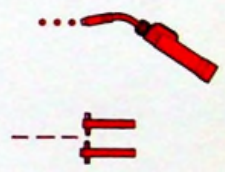

91-335

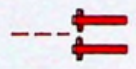

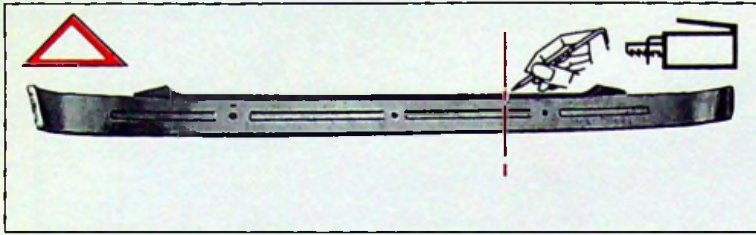

90-1141

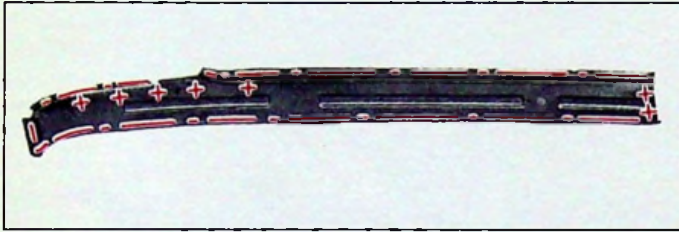

91-331



+++ Ø = 6 mm

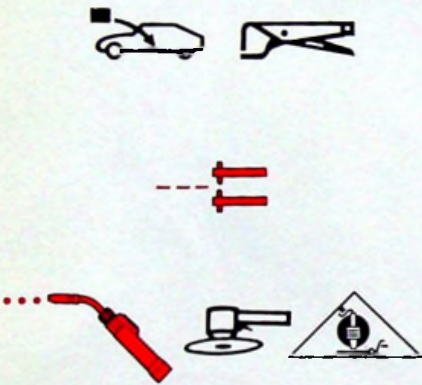

91-334

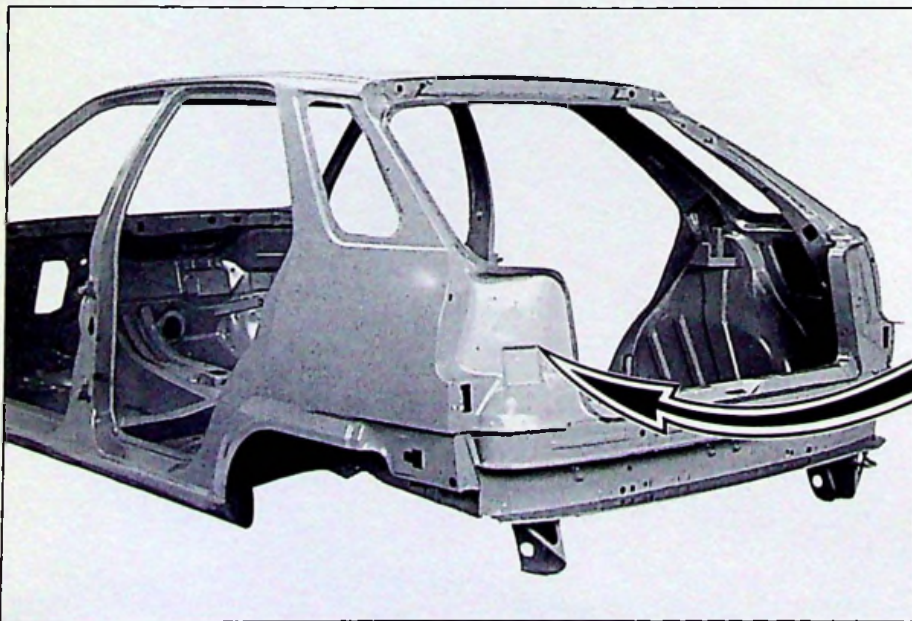

90-963

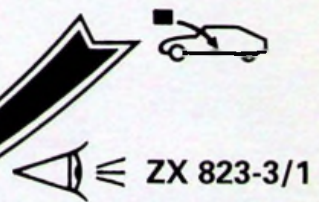



14



ZX
823-3/2

7

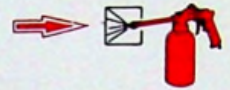

90-960

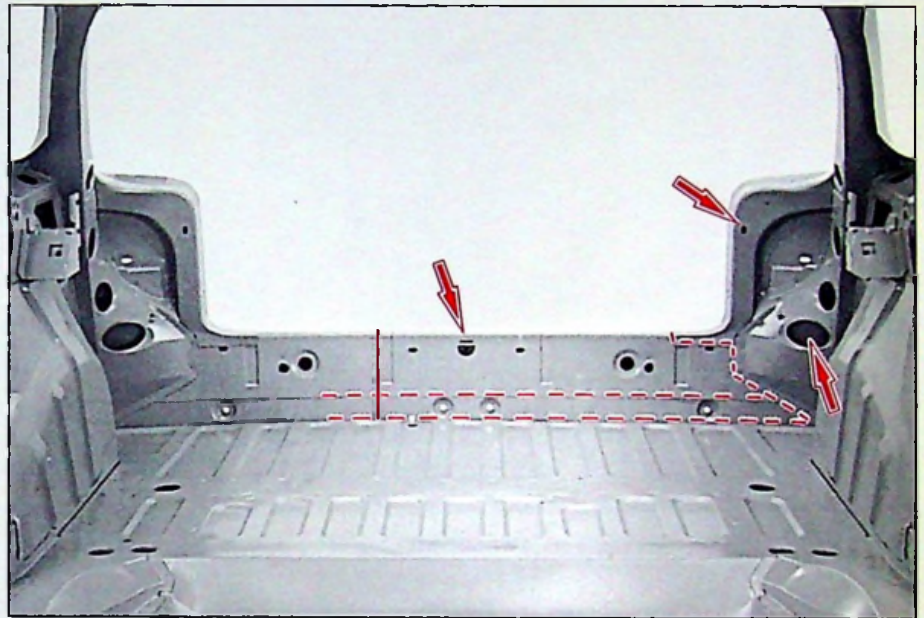

90-1093

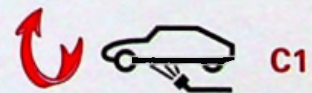

ZX 000-00/5
ZX 800-00/3

90-964



14



ZX
823-3/3

1

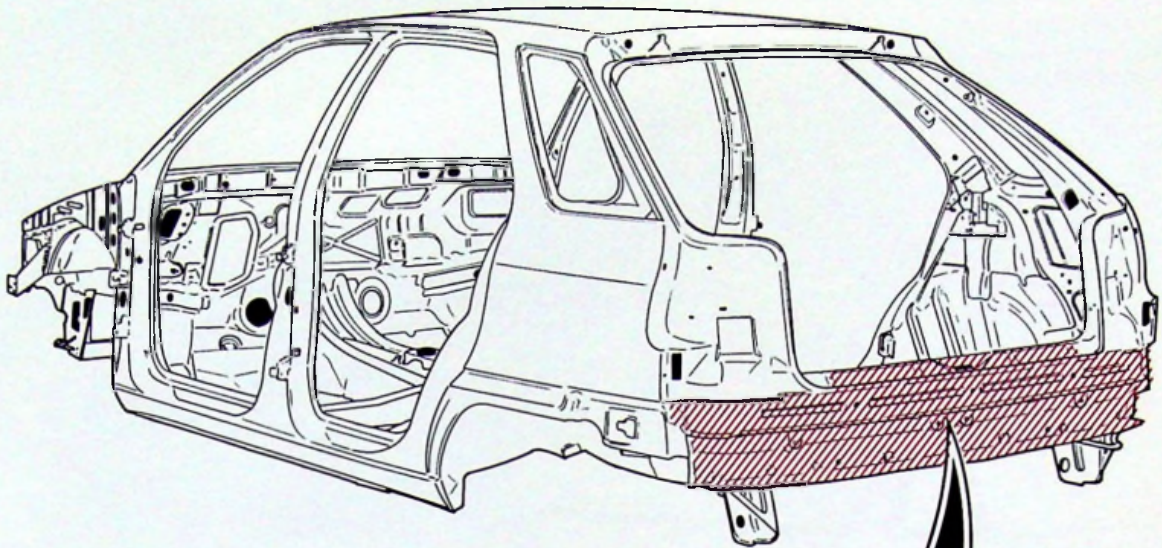

F.80-11

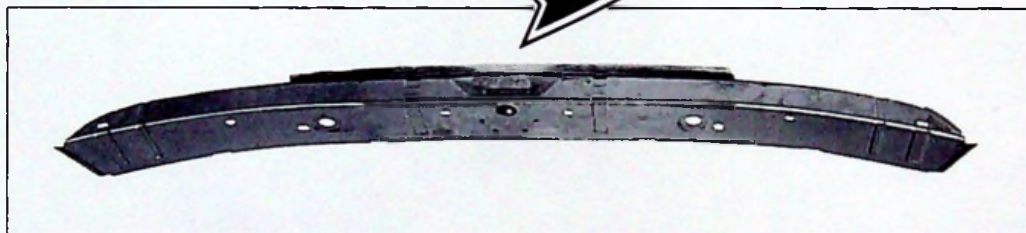

90-1140

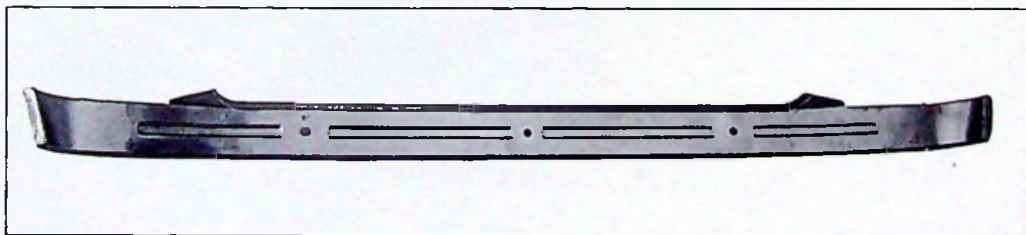

90-1141

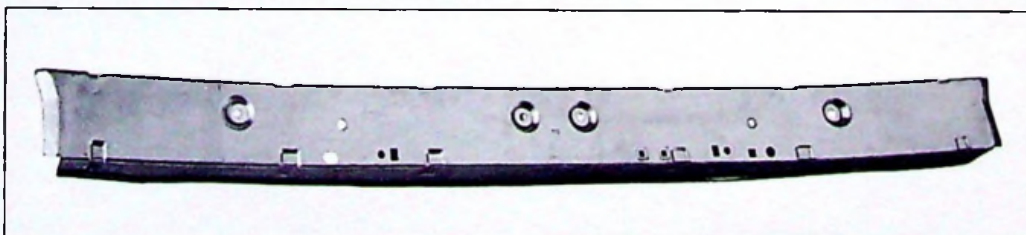

90-1142

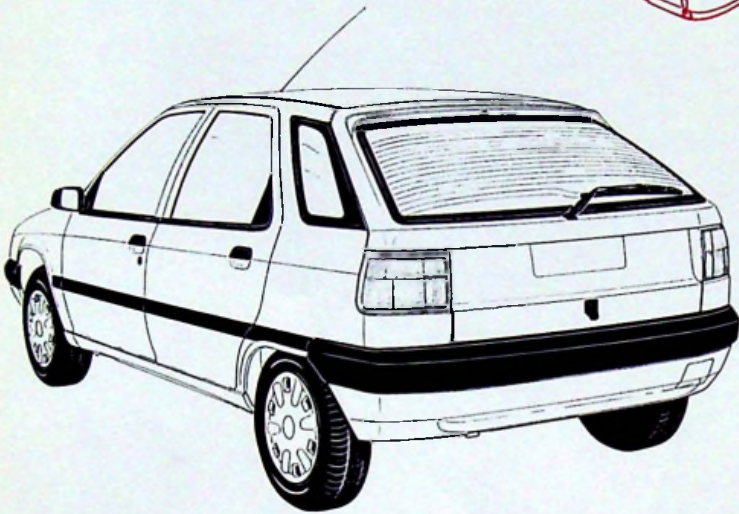
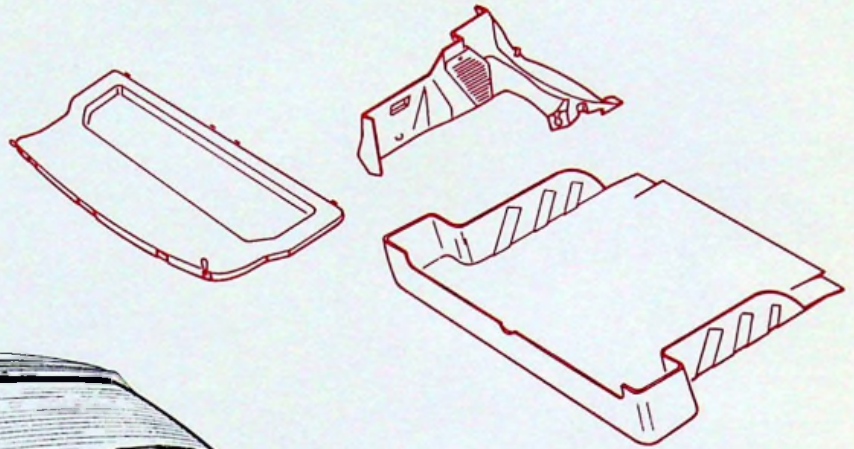
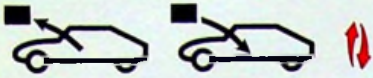

- F. 80-13
- F. 80-19
- F. 80-20
- F. 80-28



14



ZX
823-3/3

3

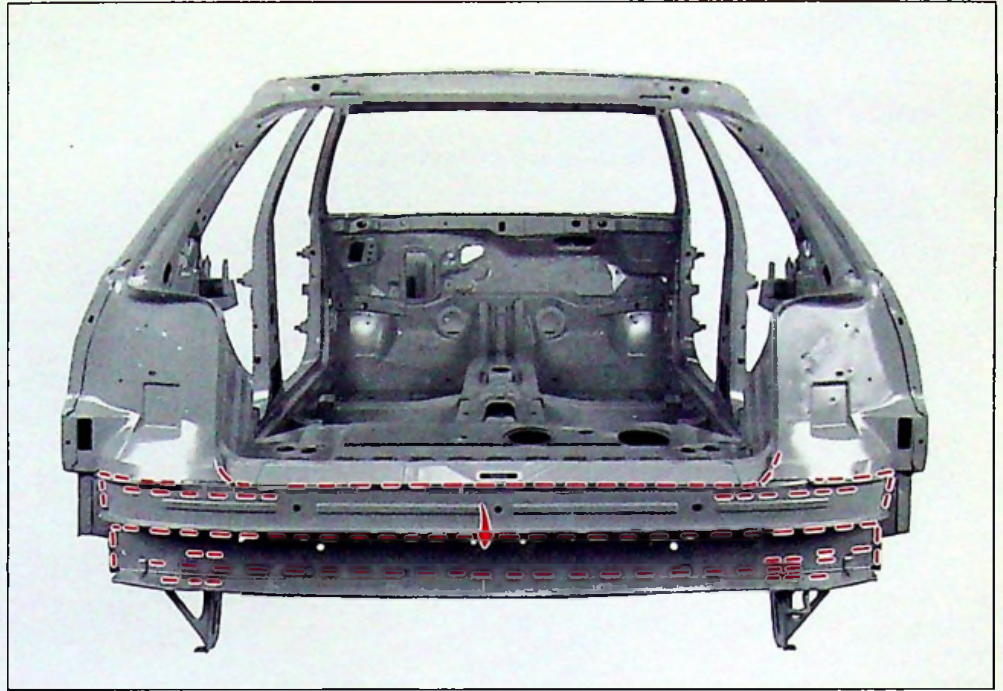

90-960

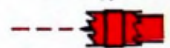
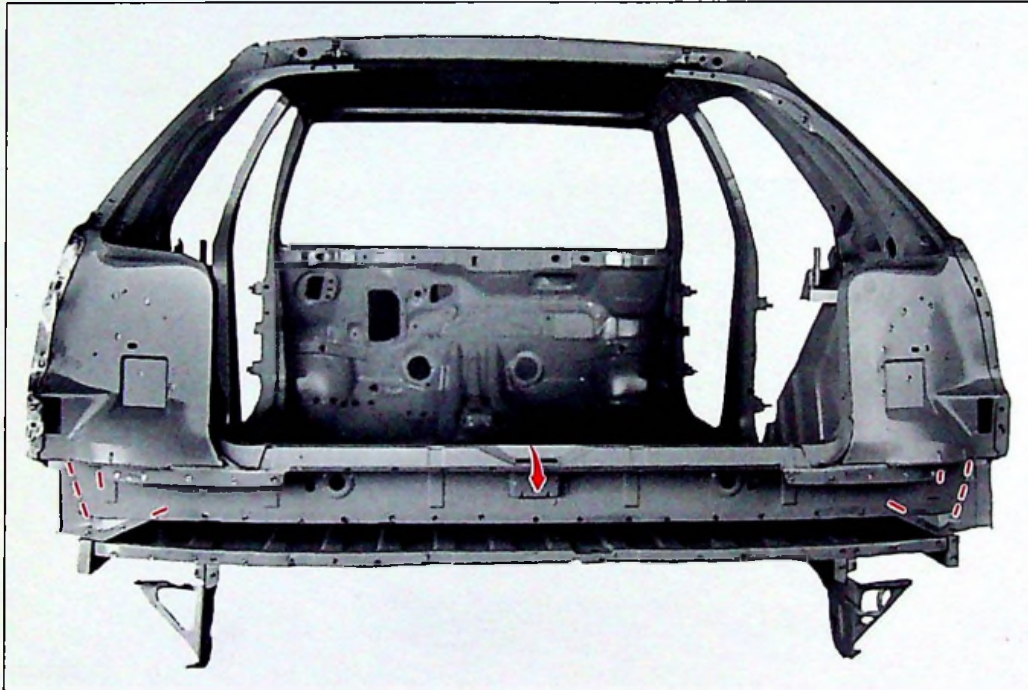

90-1647

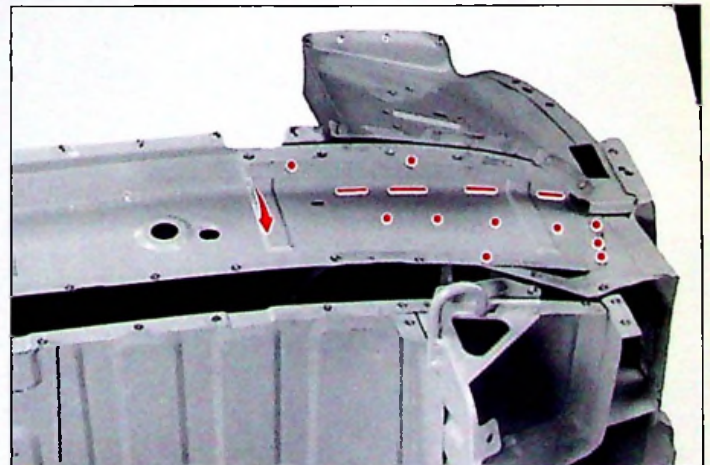

90-1652

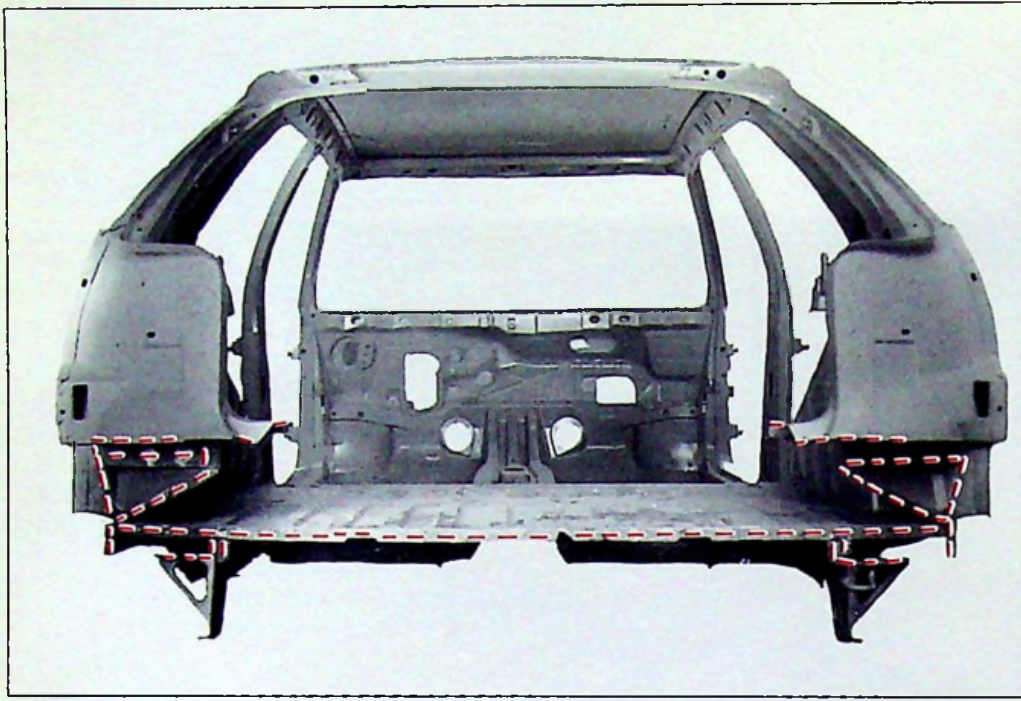

91-497

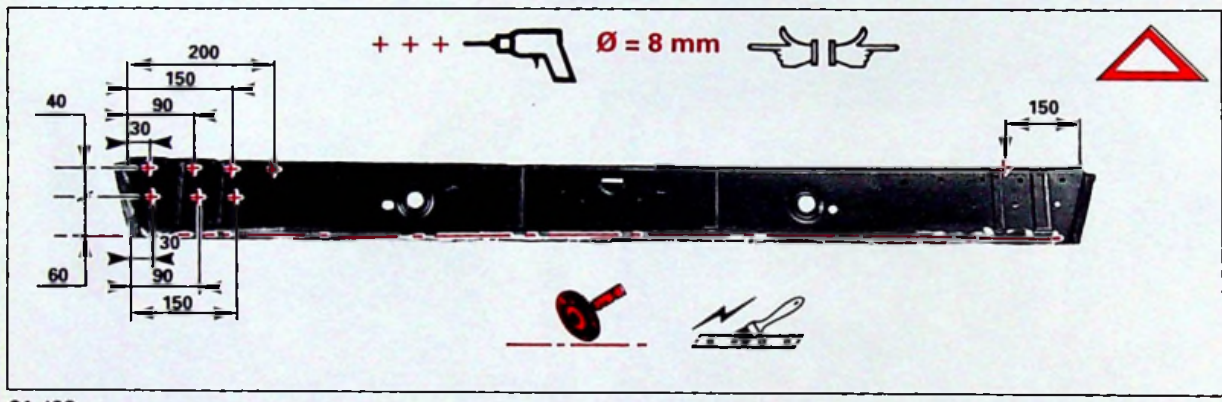

91-498

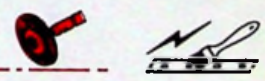
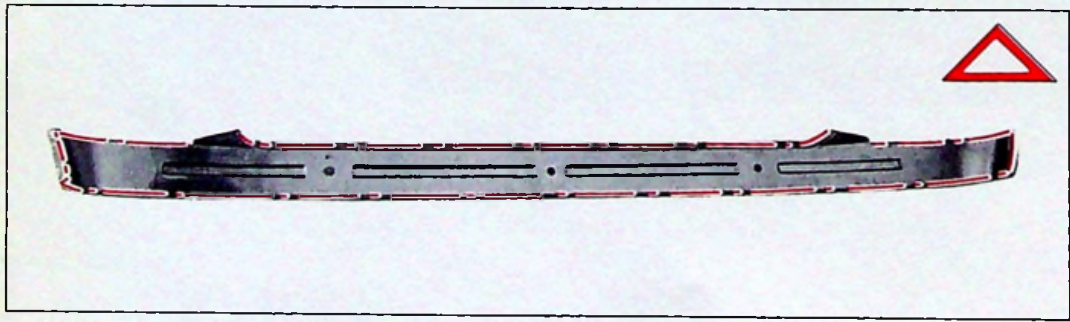

90-1141

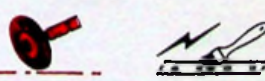
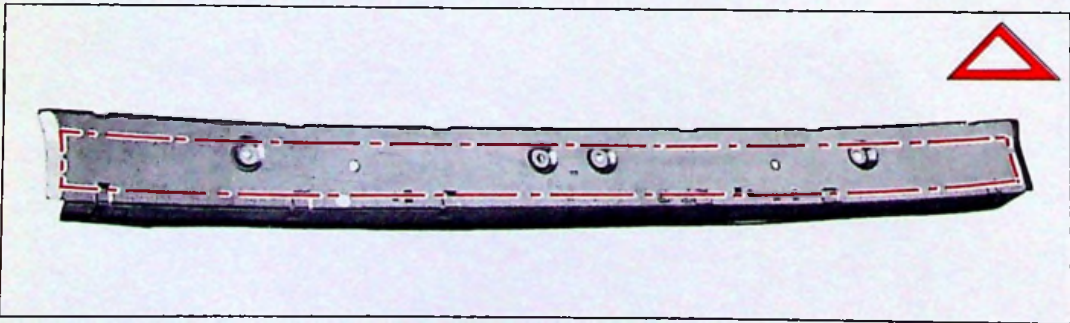

90-1142



14



ZX
823-3/3

5

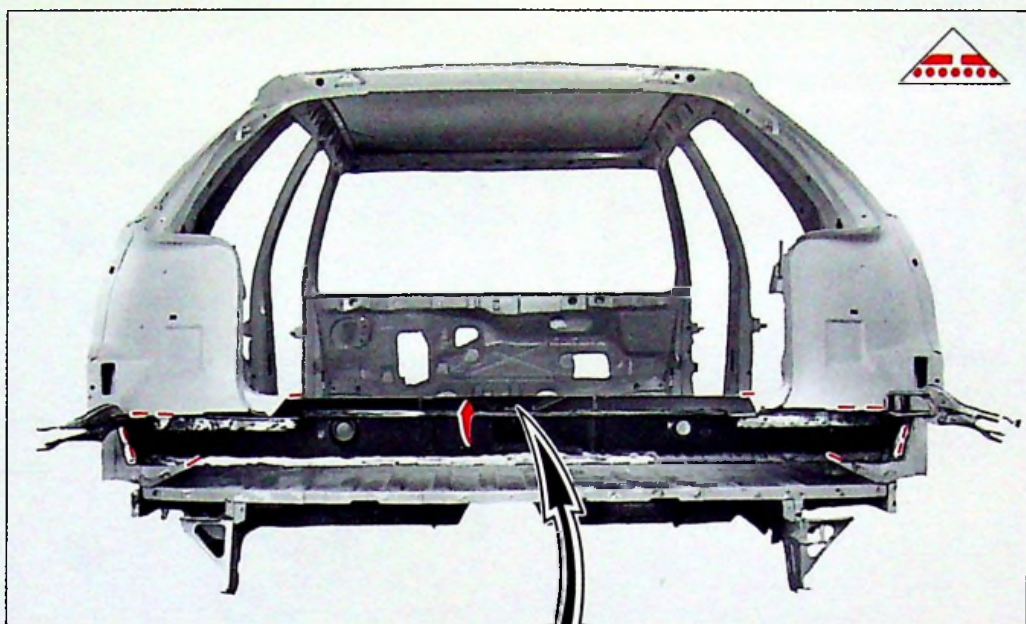

91-495



91-498

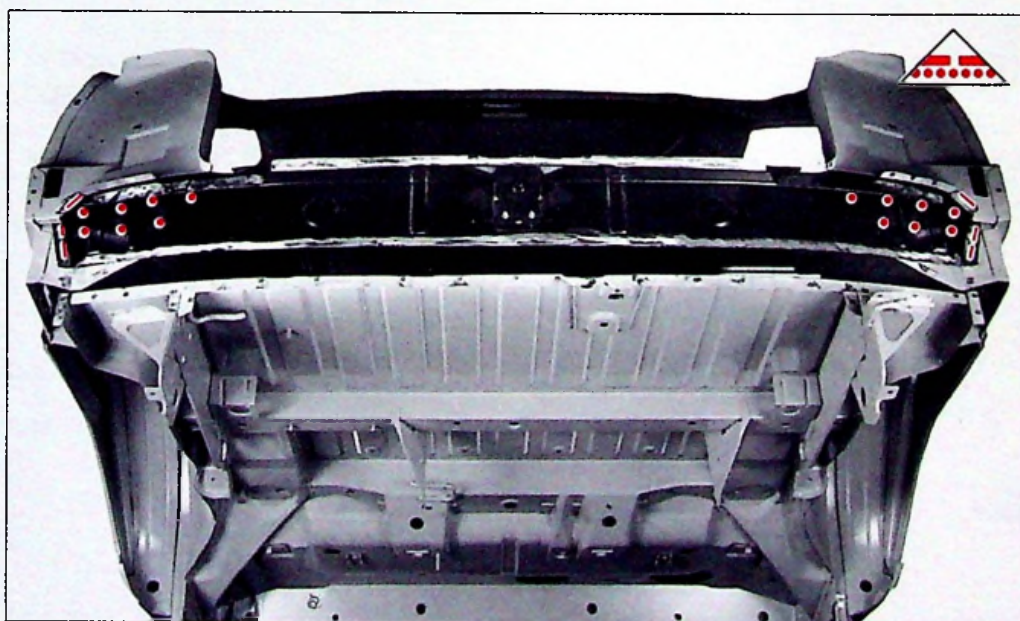
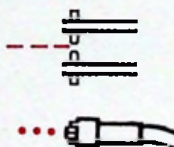

91-496

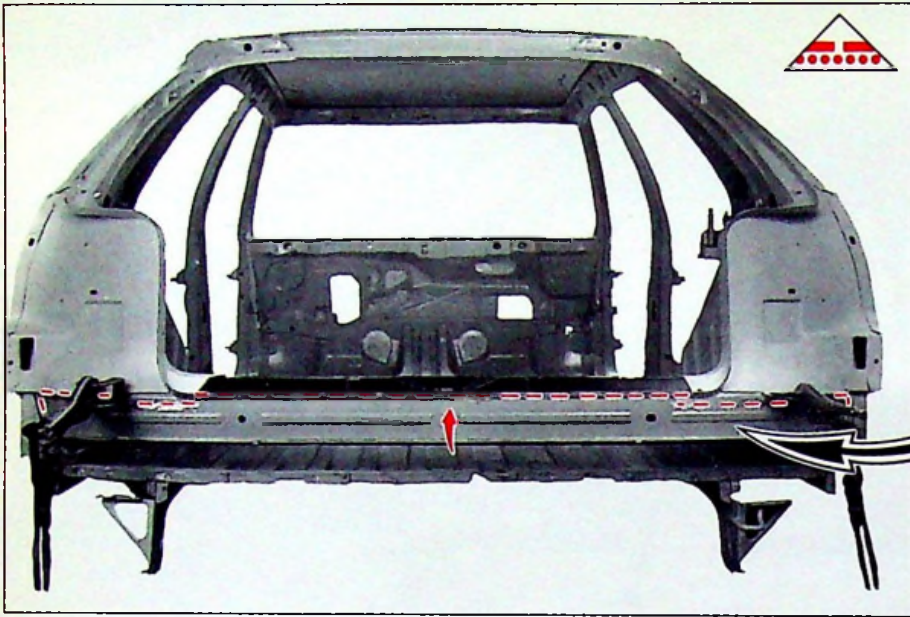

91-494



90-1141

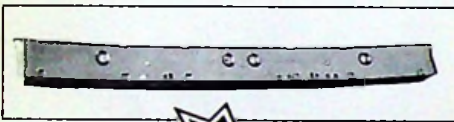
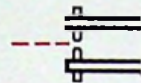

90-1142

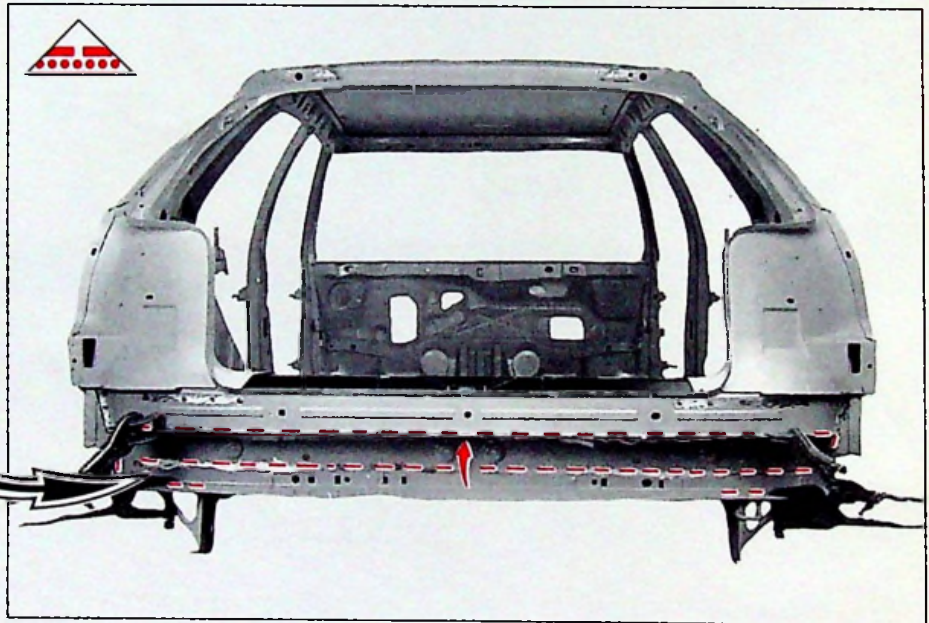
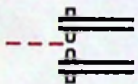

91-493

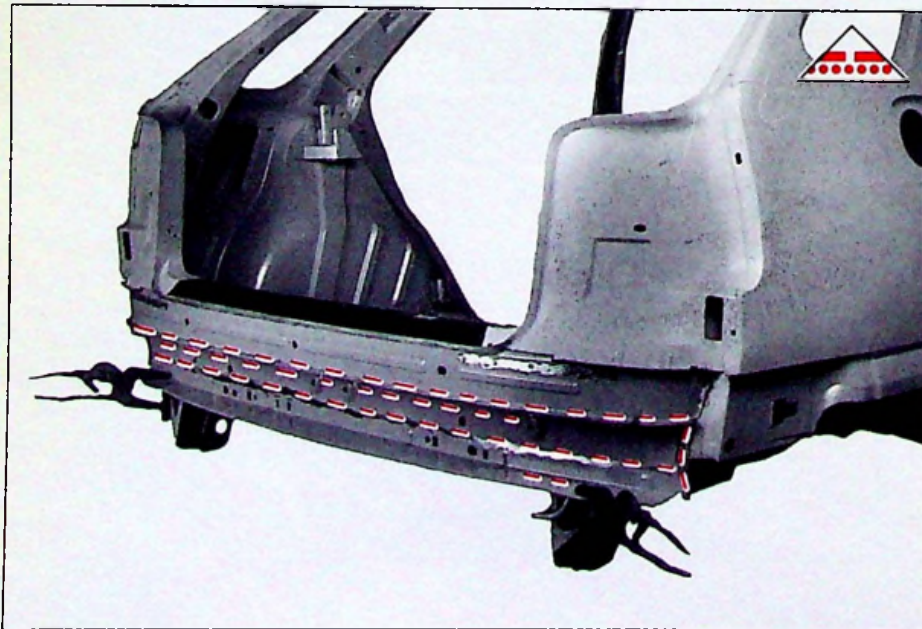

91-492

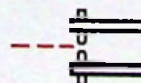



14



ZX
823-3/3

7

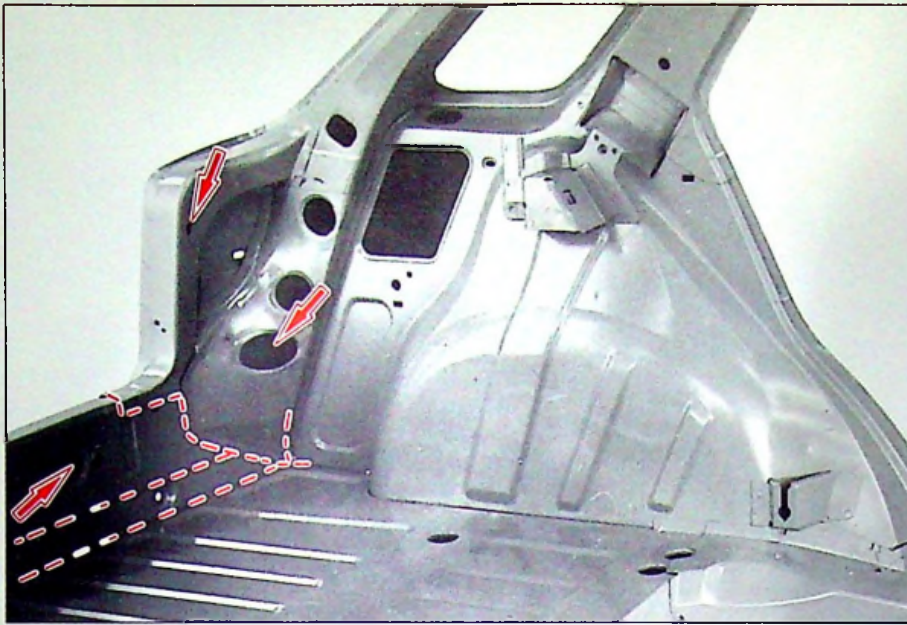

90-1099



90-960

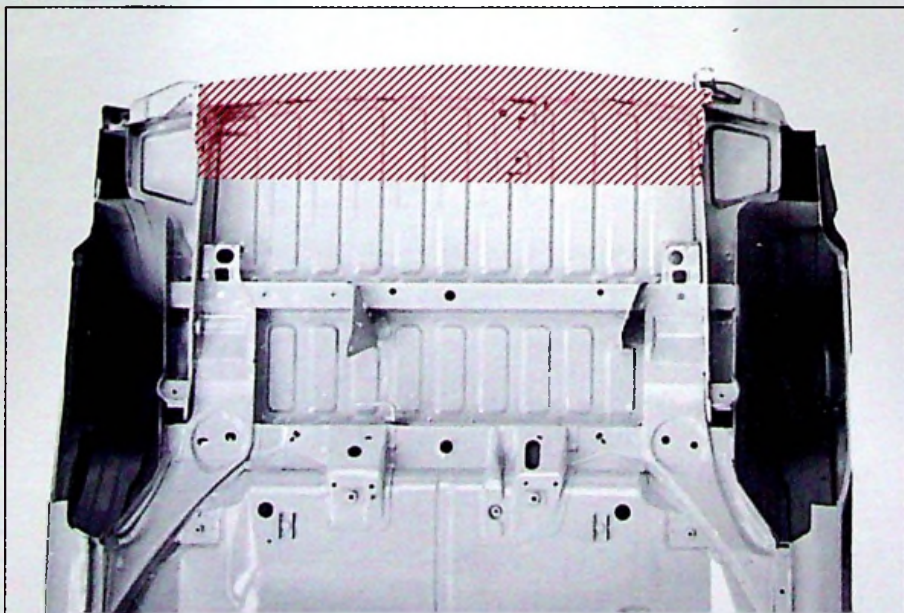

90-1070

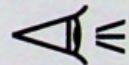
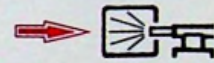
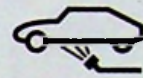

ZX 000-00/5

ZX 800-00/3



14



ZX
825-3/1

1

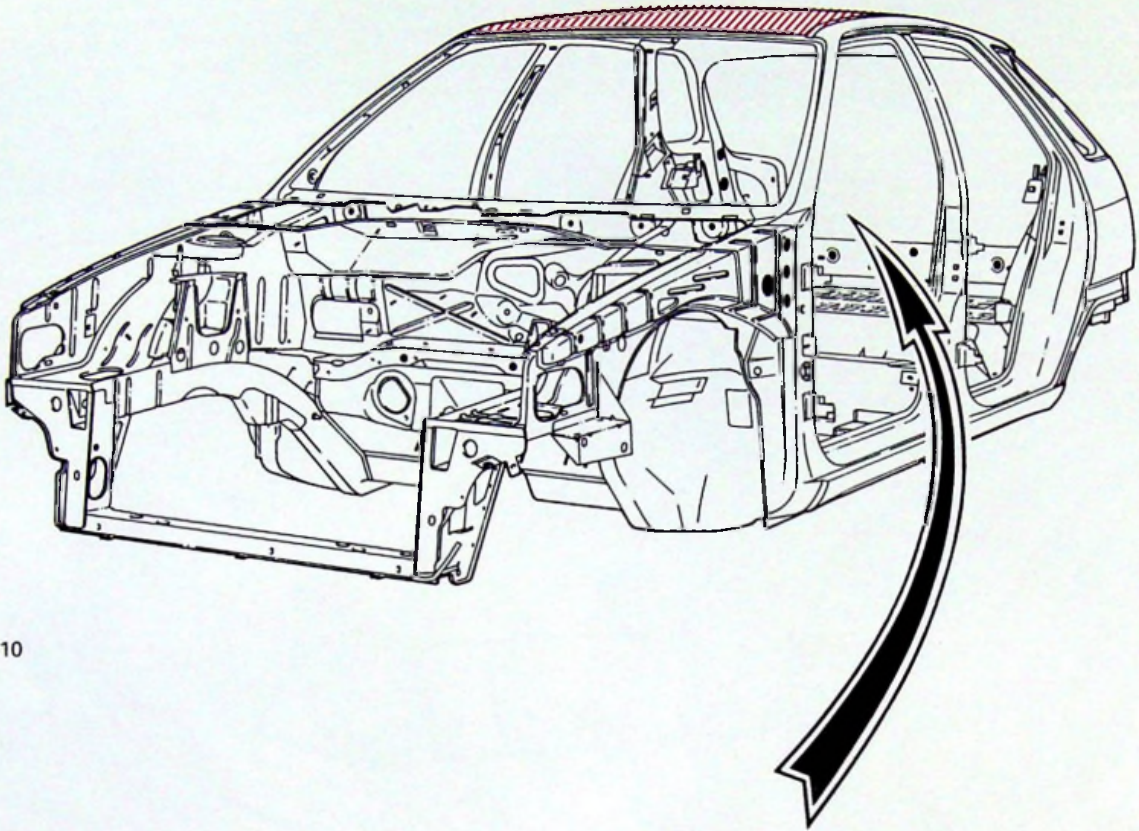

F.80-10



90-1156



90-1158



90-1157

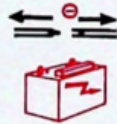
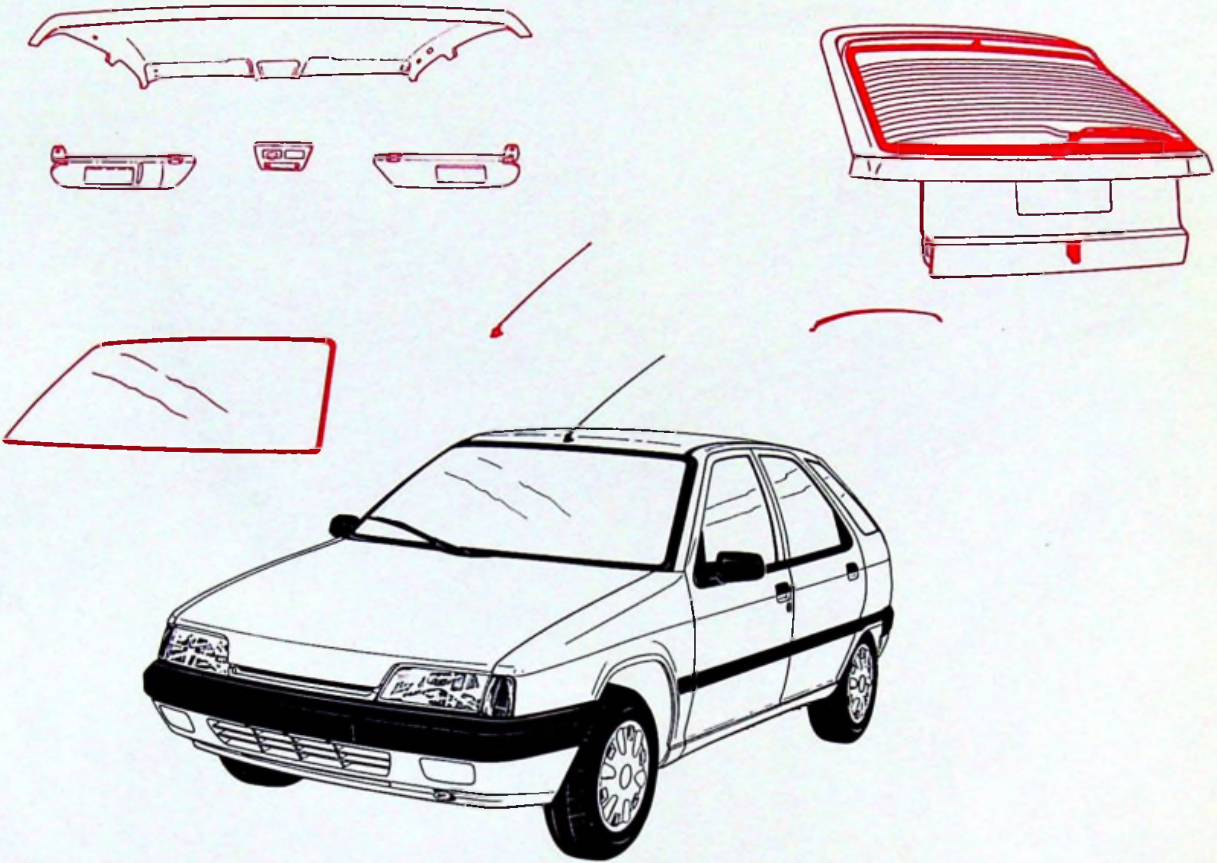
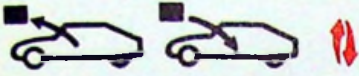



14



ZX
825-3/1

3

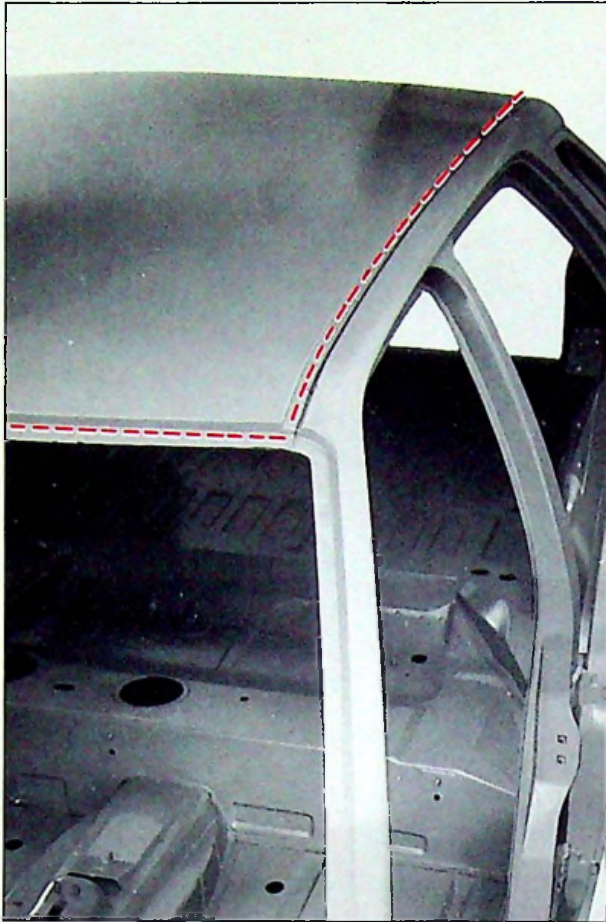

90-1080



90-959



90-1229



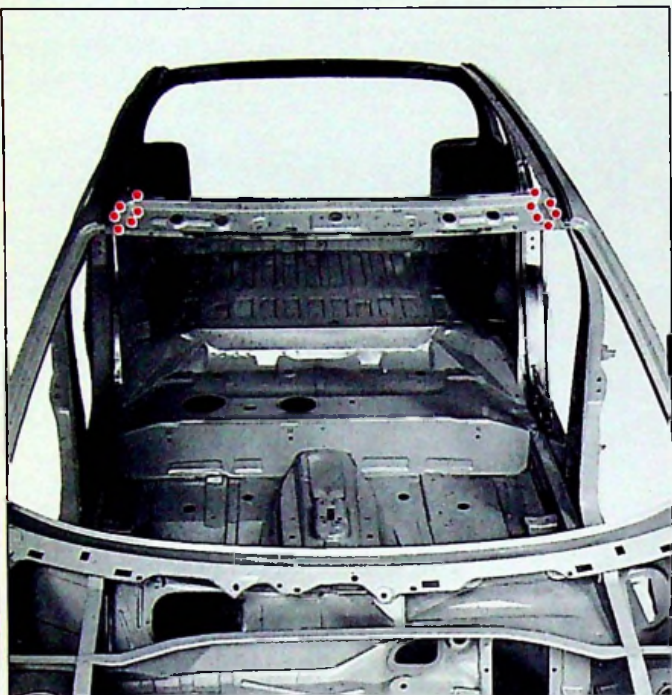
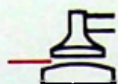
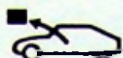
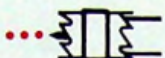

90-1242

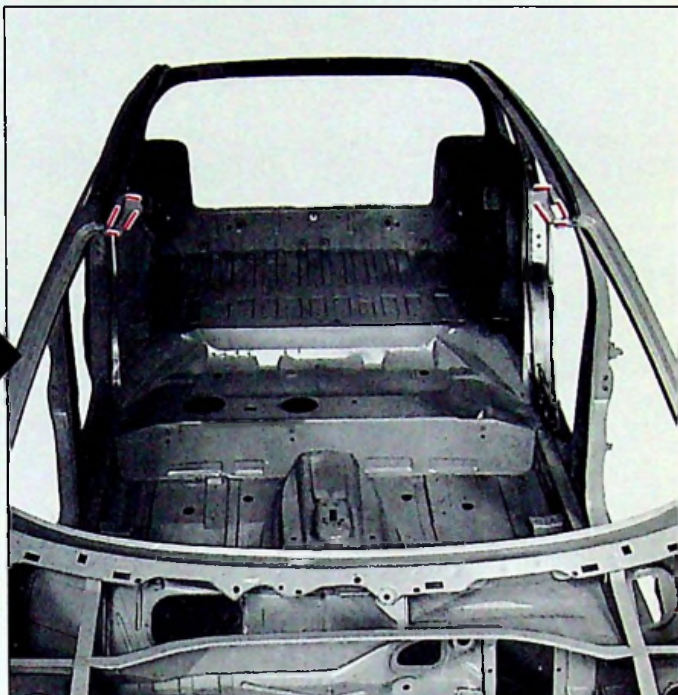

90-1239

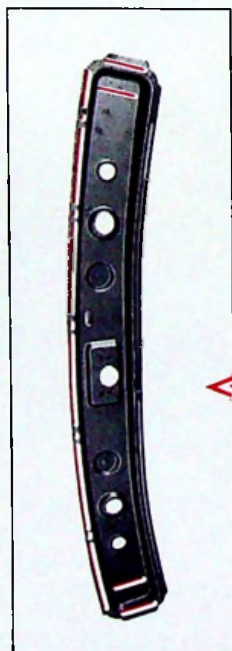

90-1156

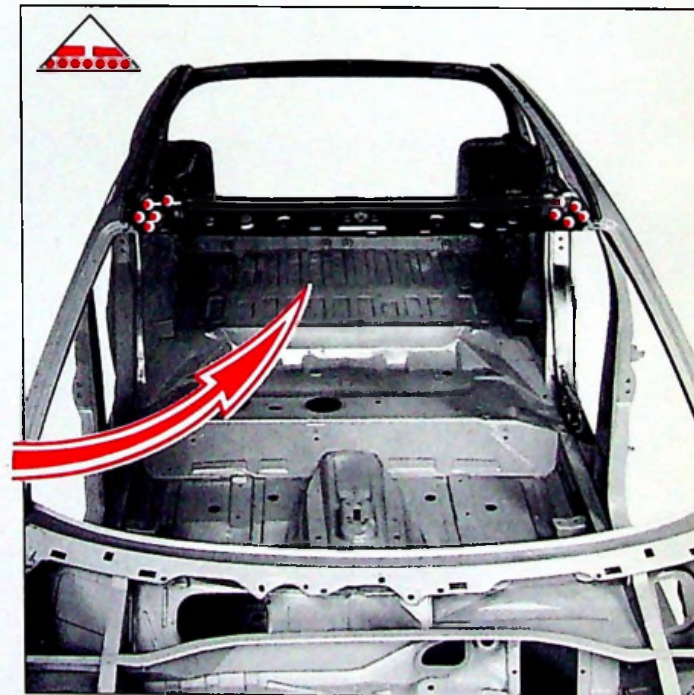
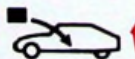

90-1238

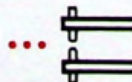



14



ZX
825-3/1

5

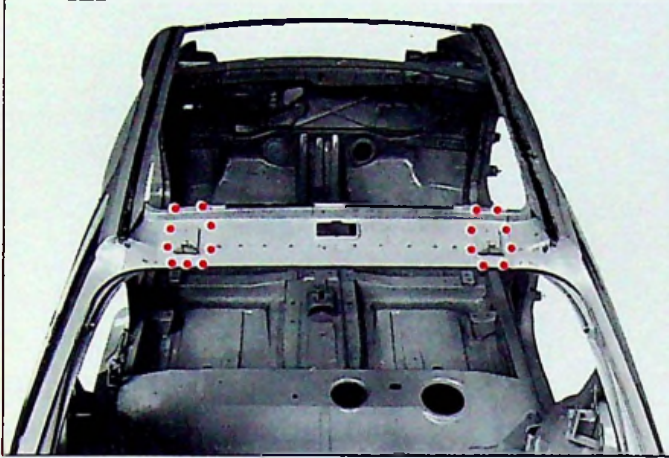
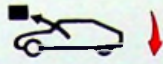

90-1241



90-1237



90-1157

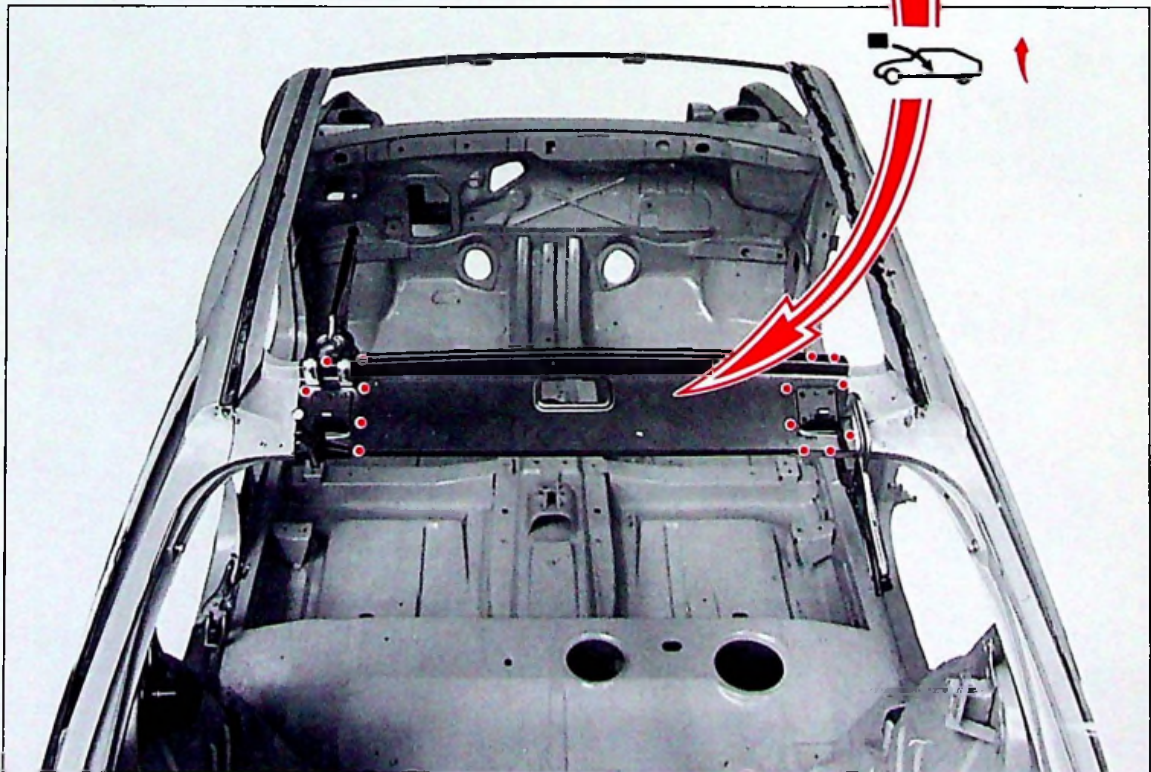

90-1240

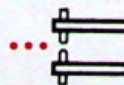



90-1158

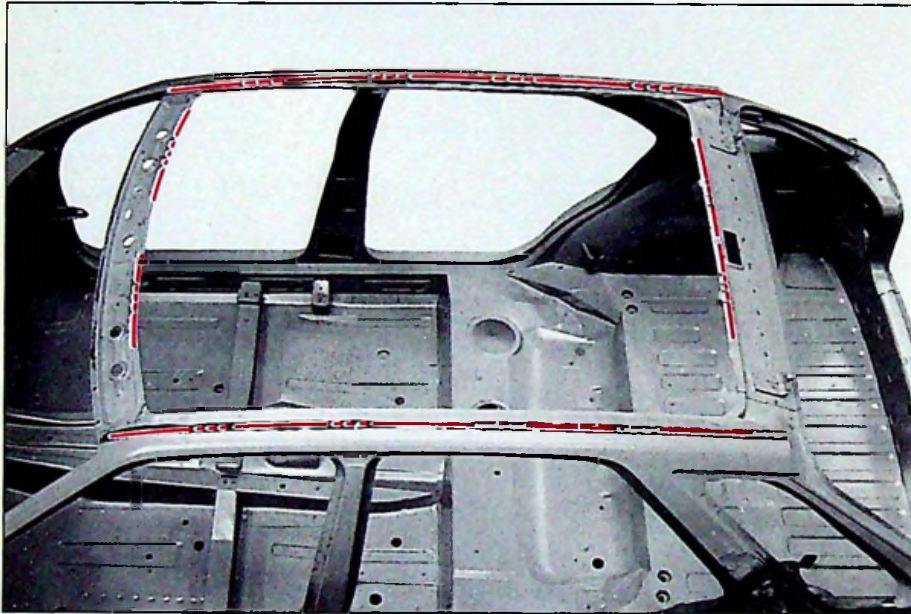

90-1229

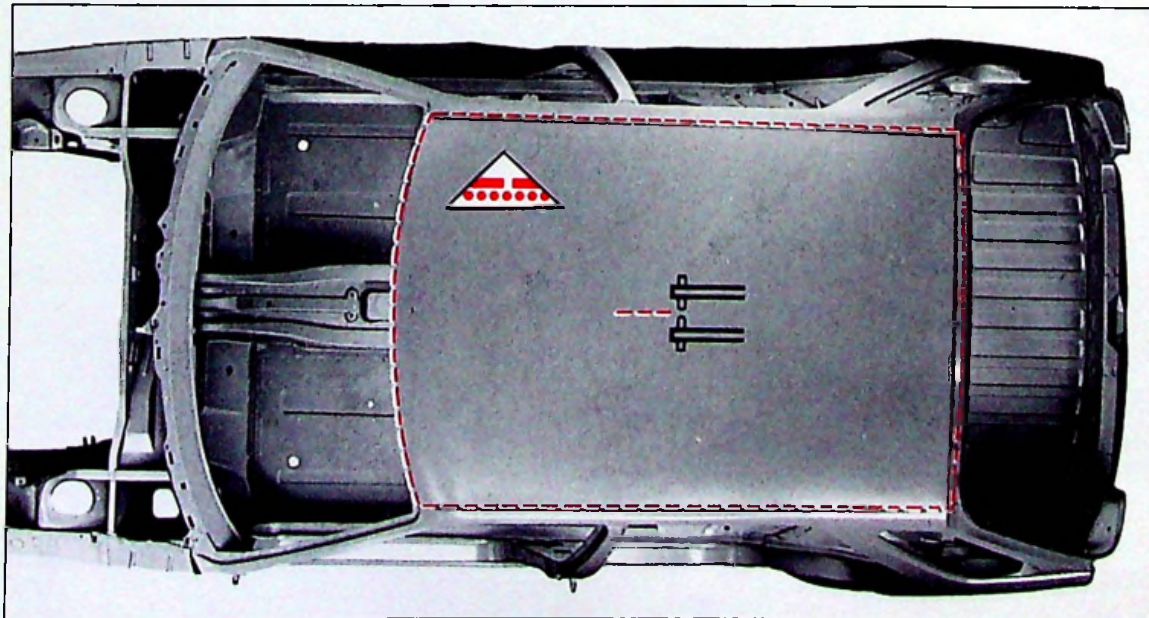

90-1066



14



ZX
825-3/1

7



90-1080



A1



ZX 000-00/5

ZX 800-00/3

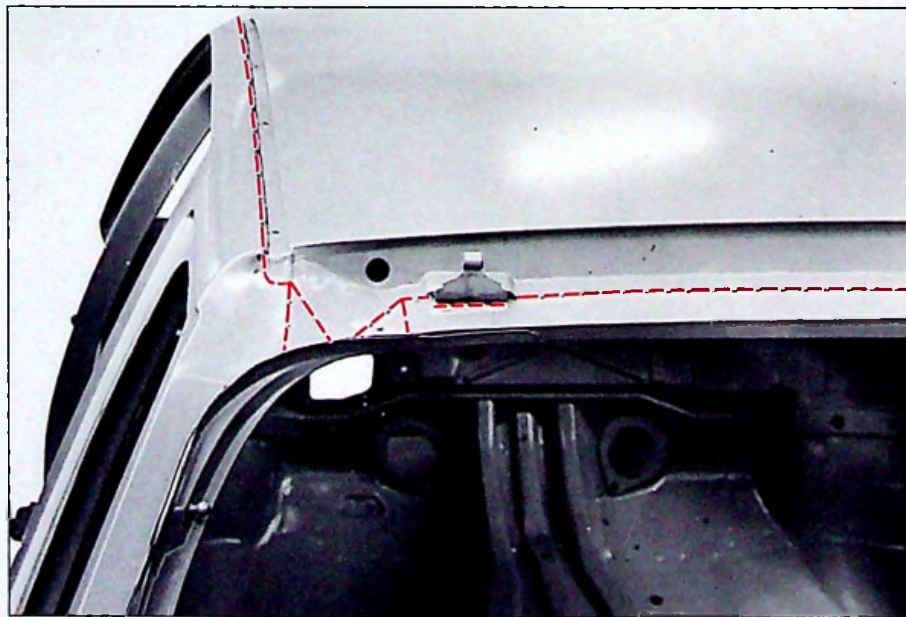

90-959



14



ZX
831-3/1

1

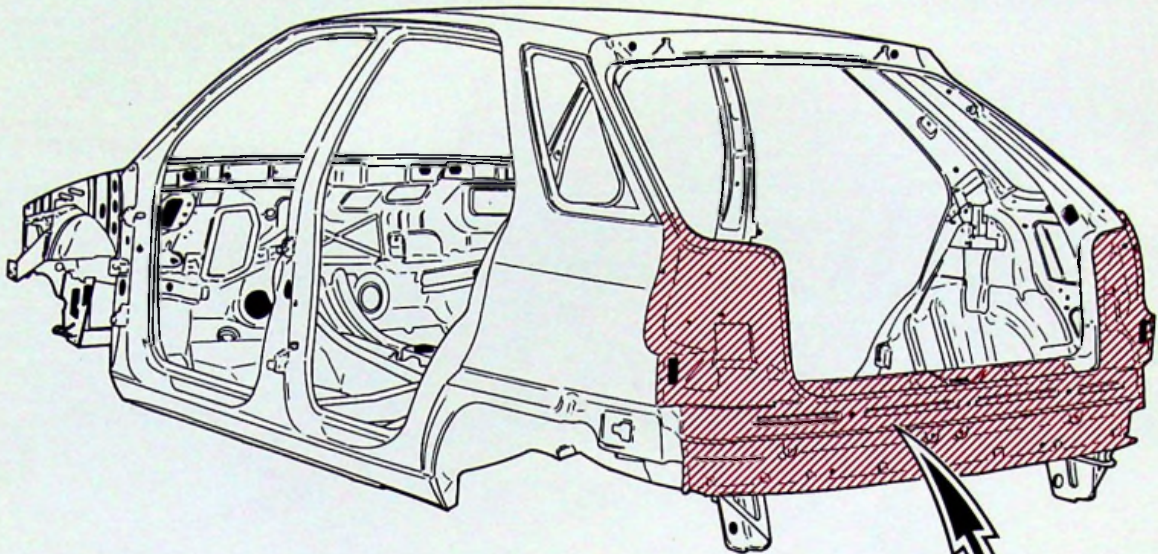

F.80-11



90-1152



90-1151



90-1140



90-1141

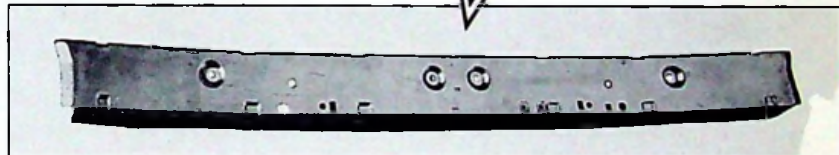

90-1142

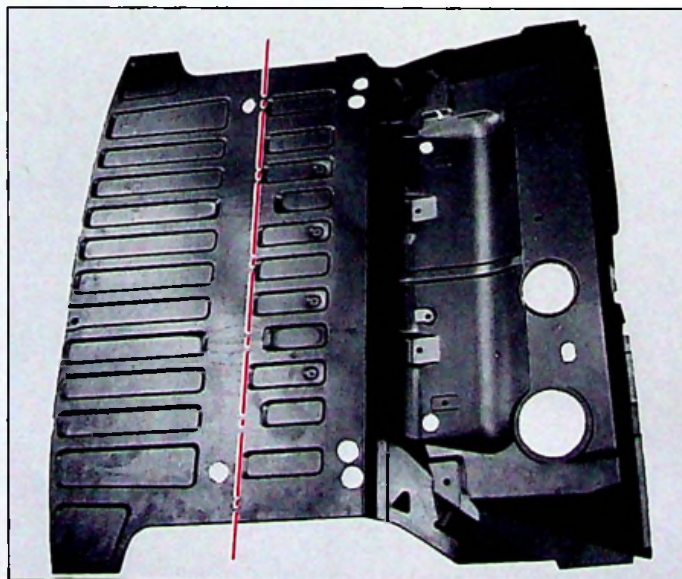

90-1155

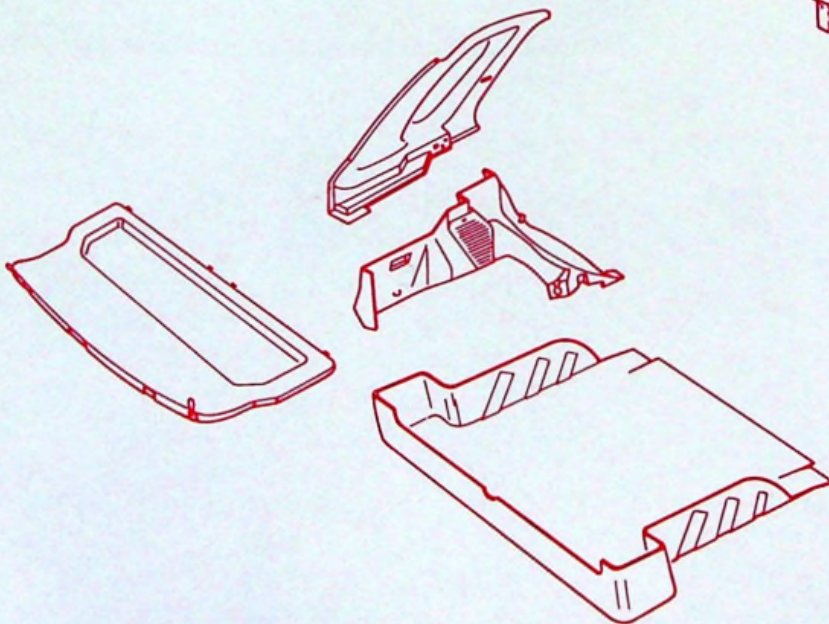
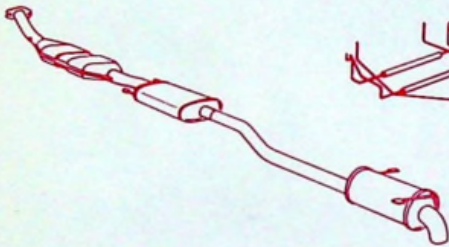
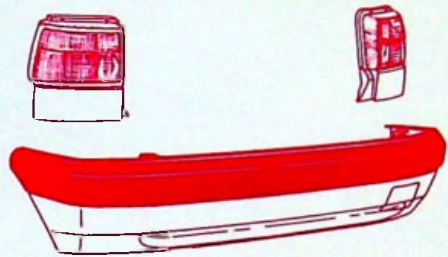
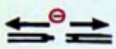
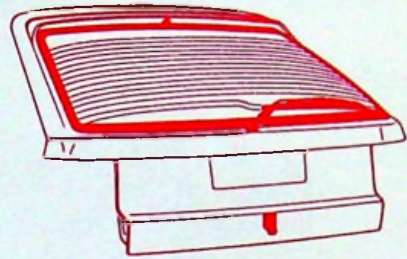
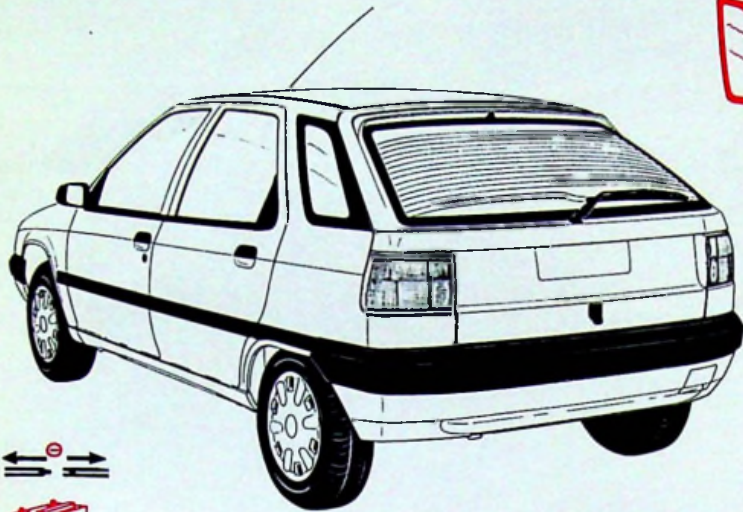
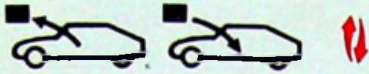
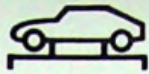

- F. 80-13
- F. 80-19
- F. 80-20
- F. 80-28
- F. 91-1



14



ZX
831-3/1

3

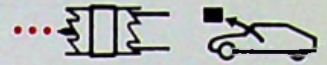
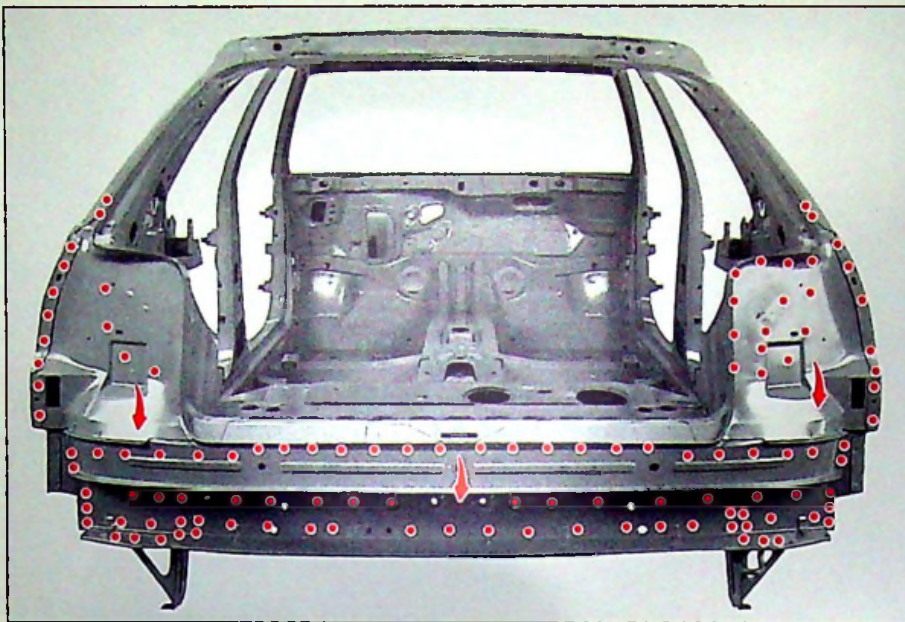

90-960

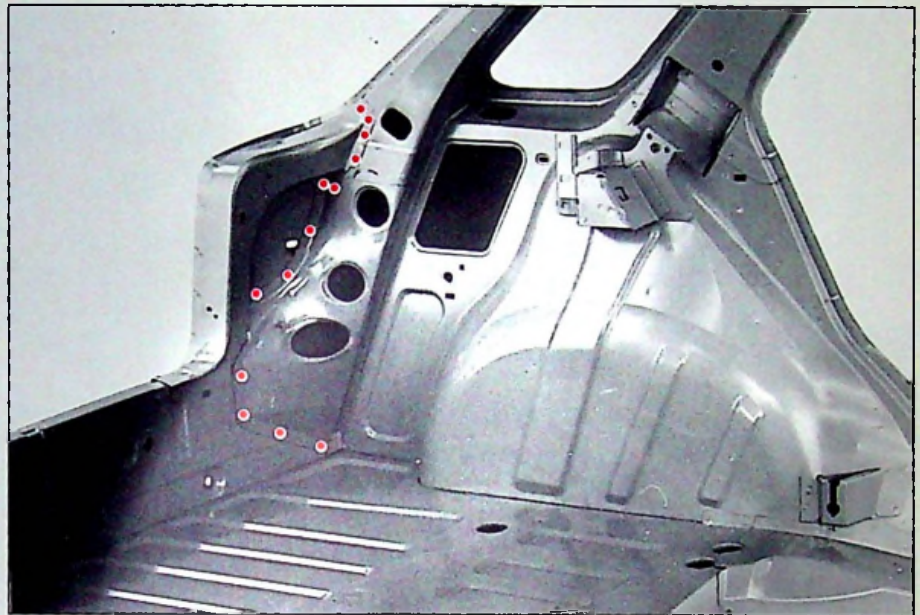

90-1099

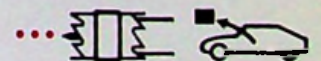
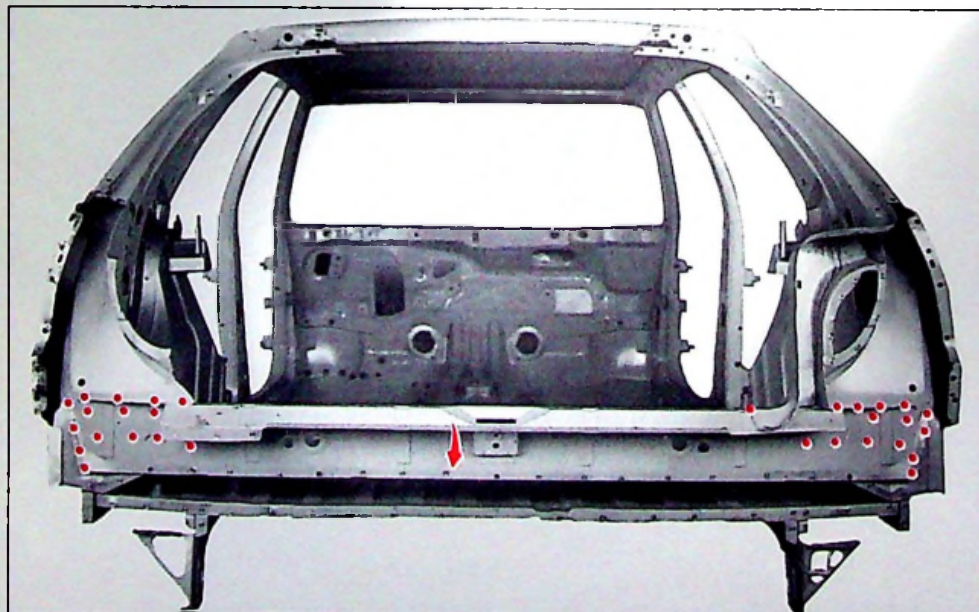

90-1648

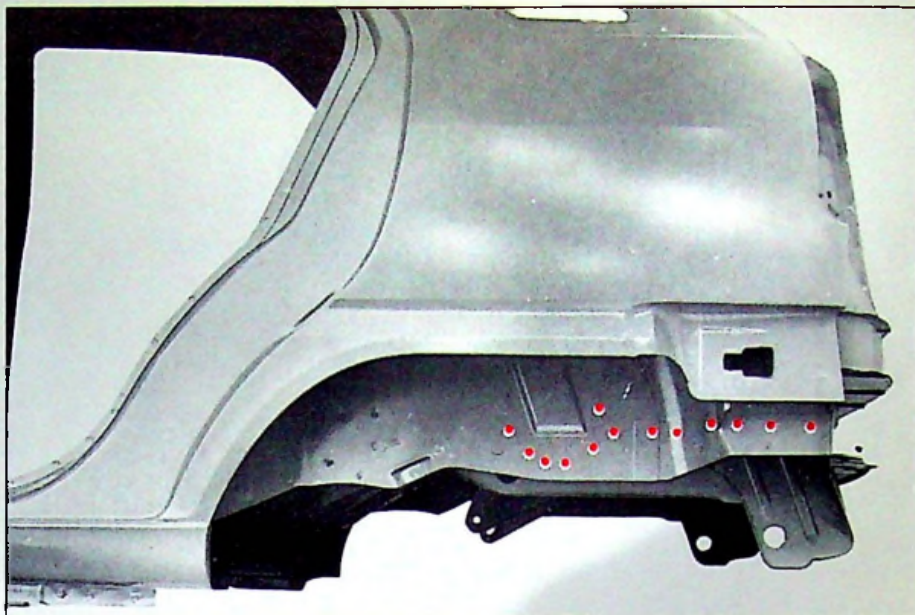
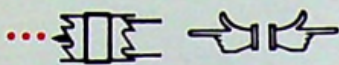
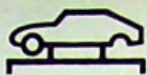

90-1086

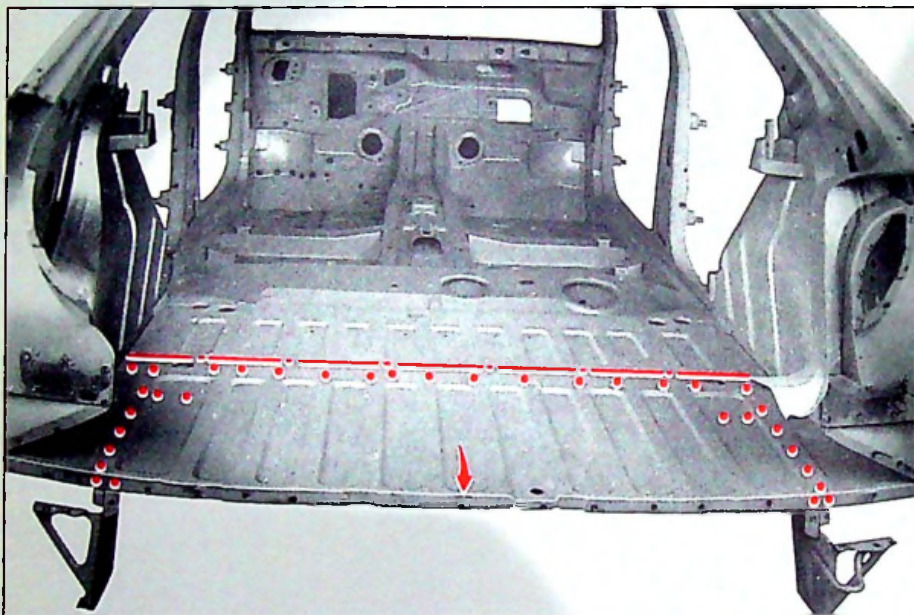

90-1653

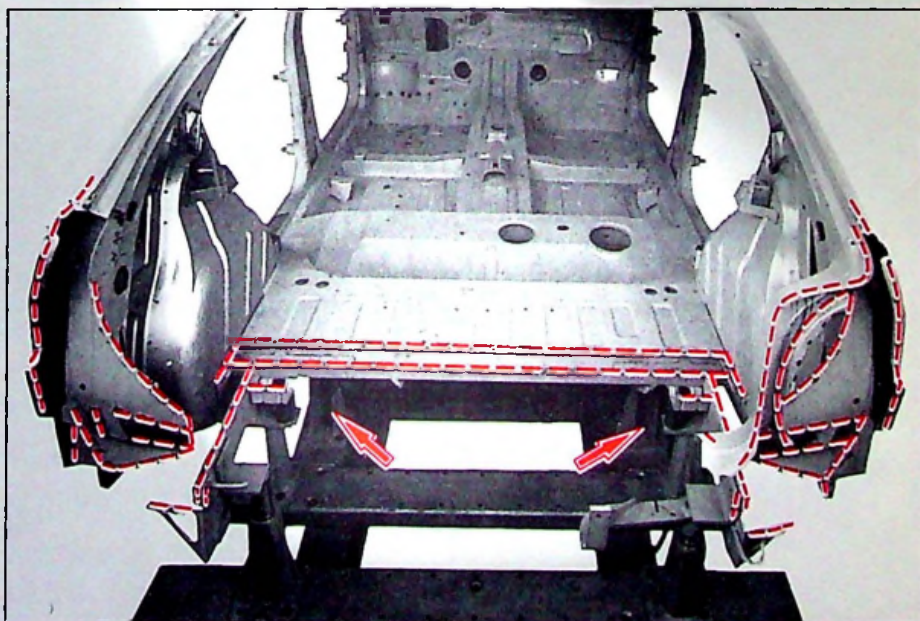
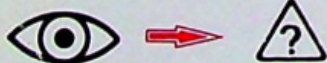
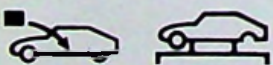
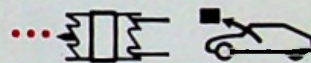
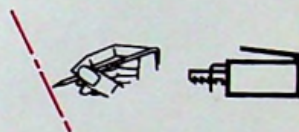

90-1654



14



ZX
831-3/1

5

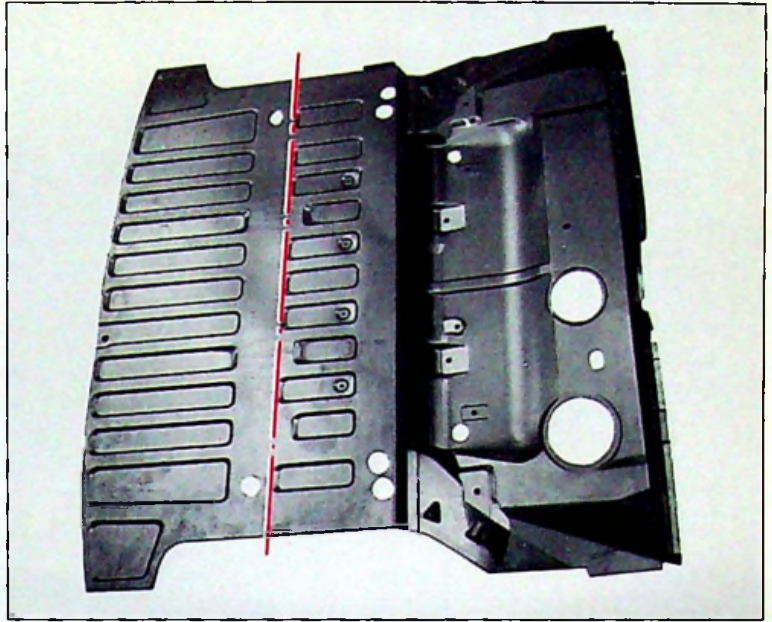

90-1155

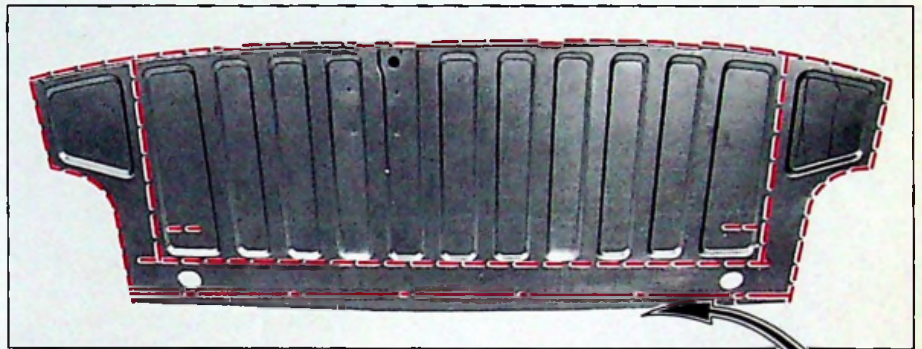

90-1656

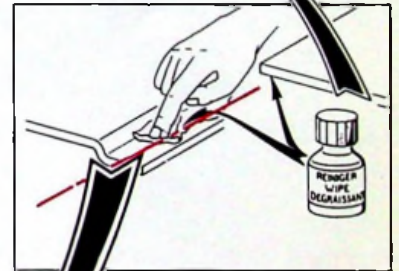

TT.80-17

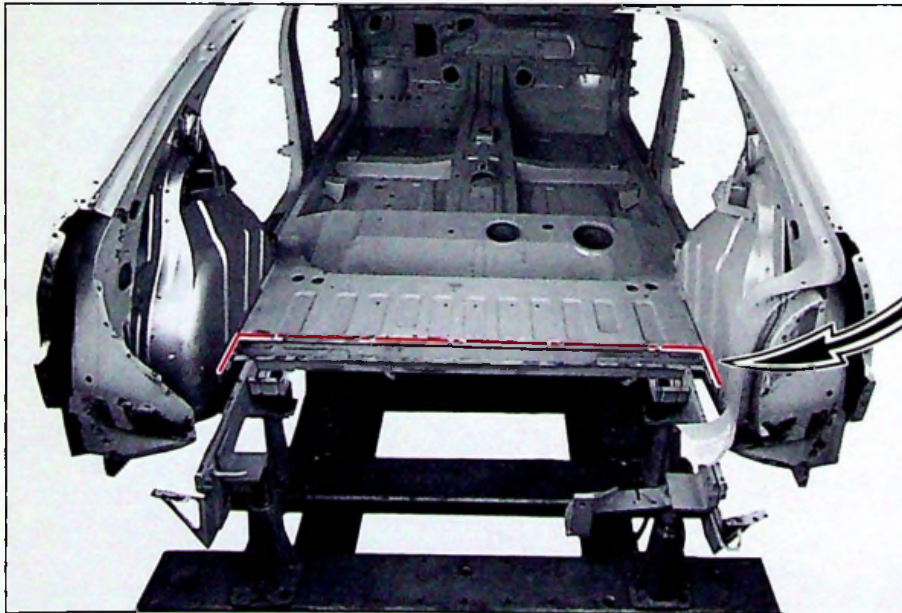

90-1654

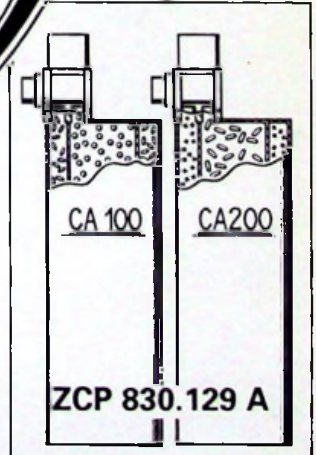

TT.80-23



EQP 000.056 A

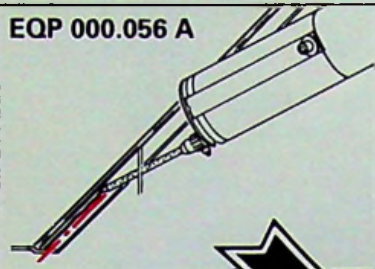

TT.80-24

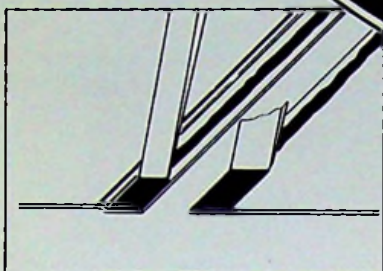

TT.80-24

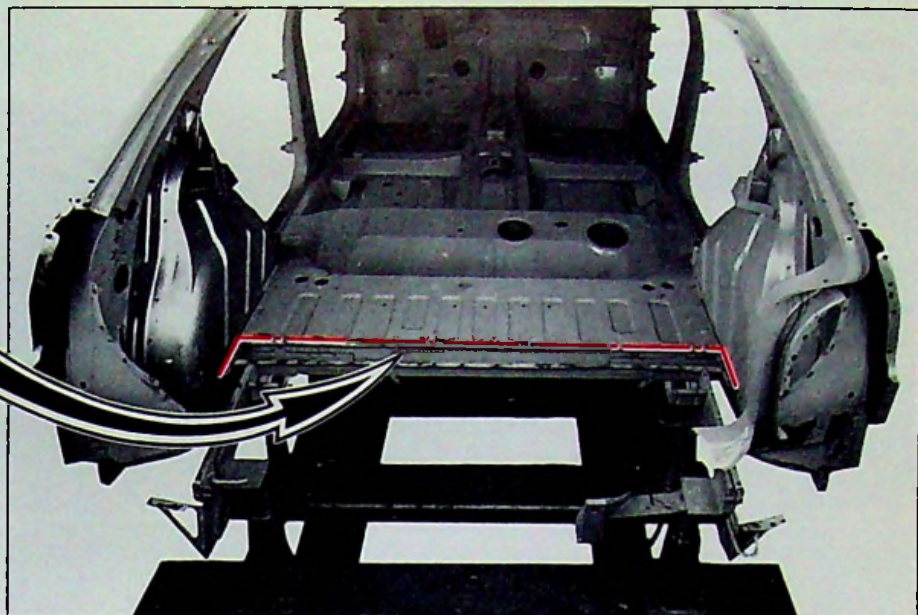

90-1654

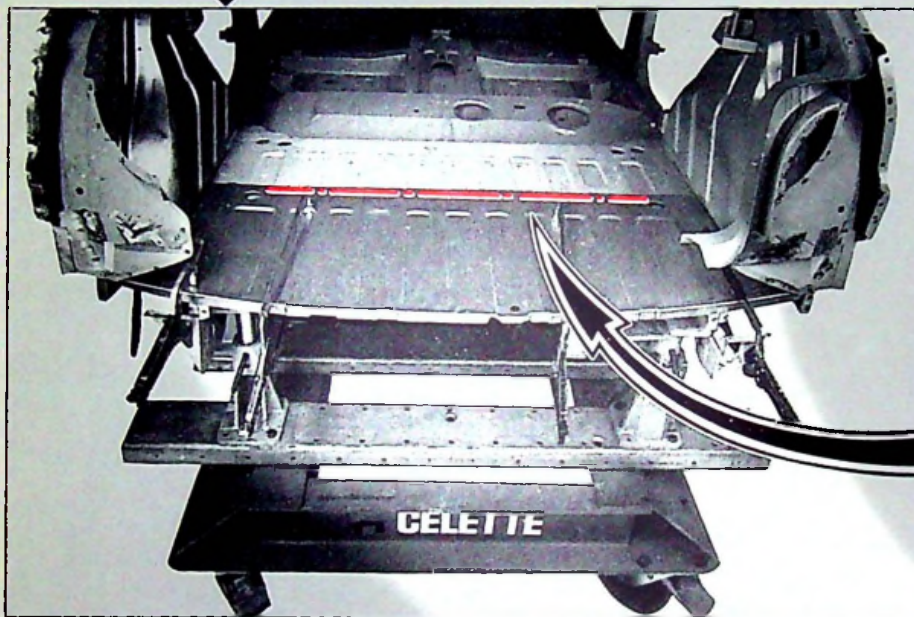

90-1657

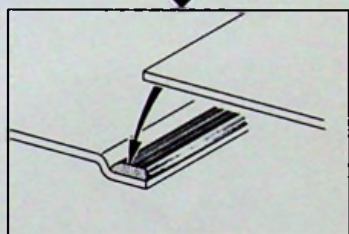

TT.80-17

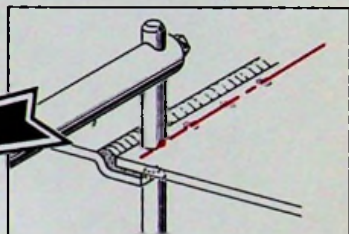

TT.80-17

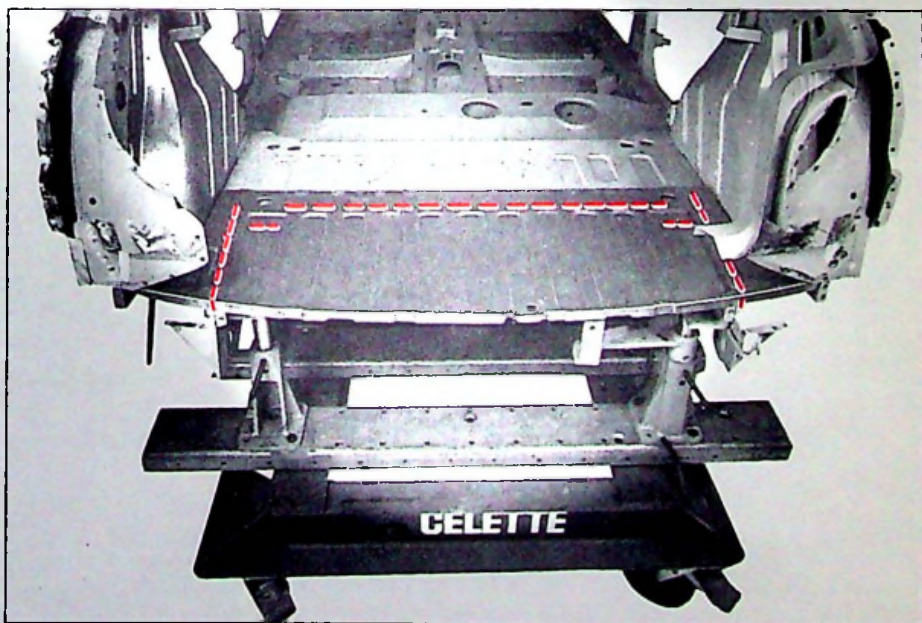
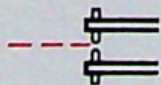

90-1658



14

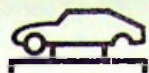

ZX
831-3/1

7

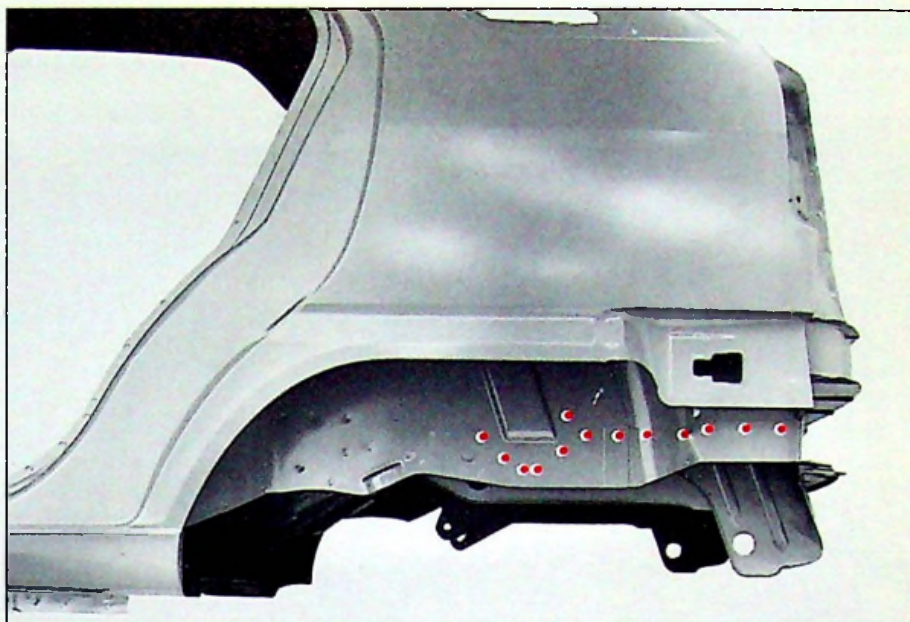

90-1086

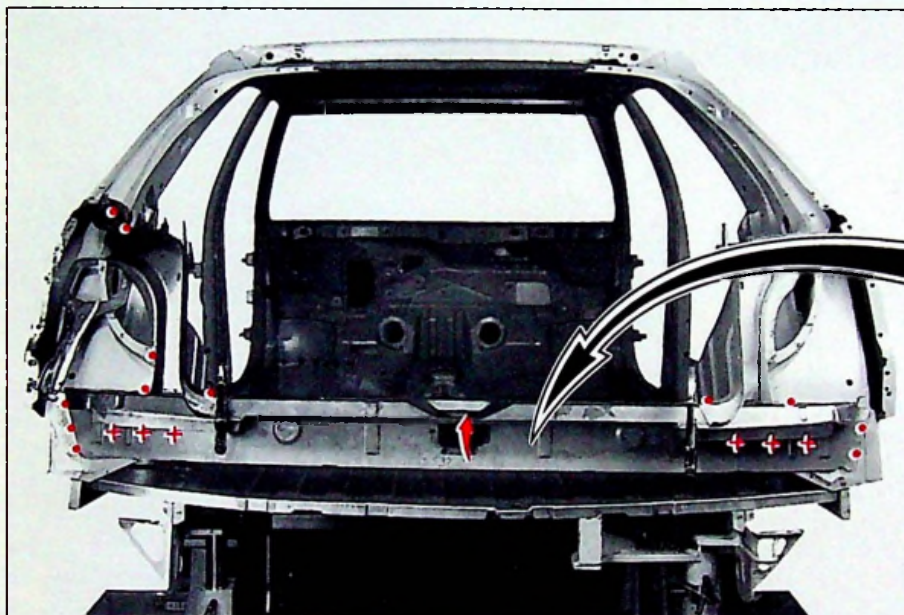

90-1659



90-1151



90-1140

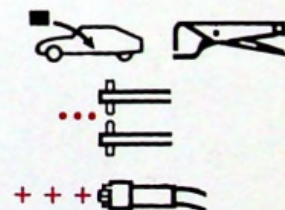

90-1141

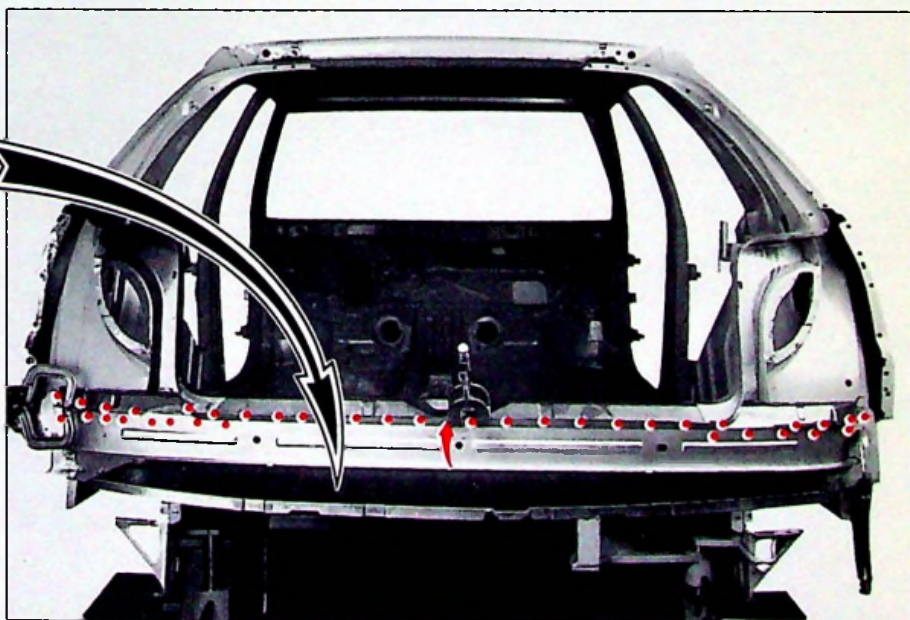
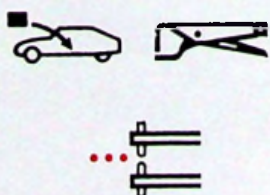

90-1660

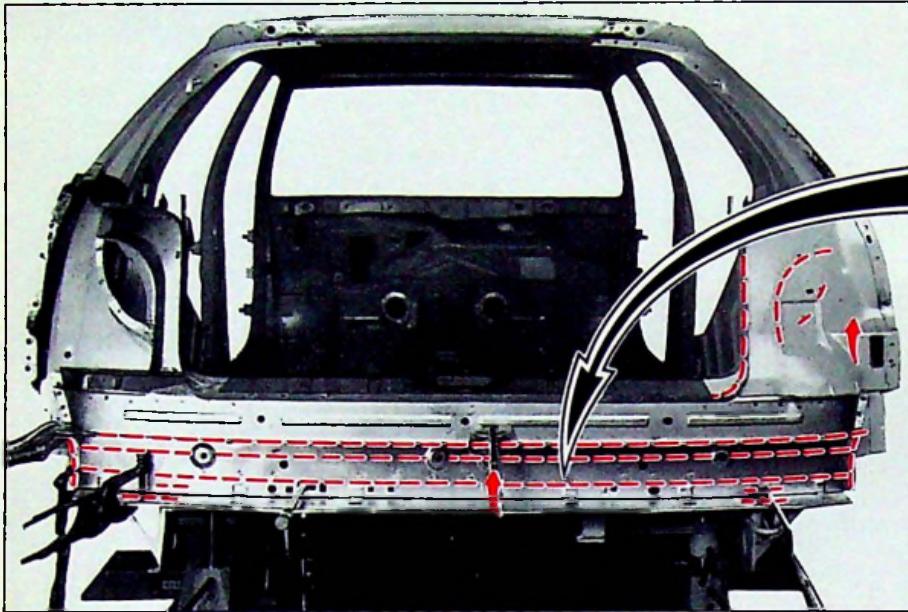
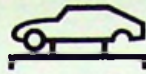

90-1665

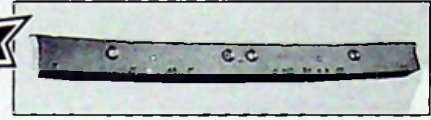

90-1142

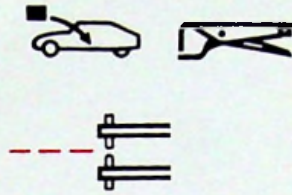

90-1152

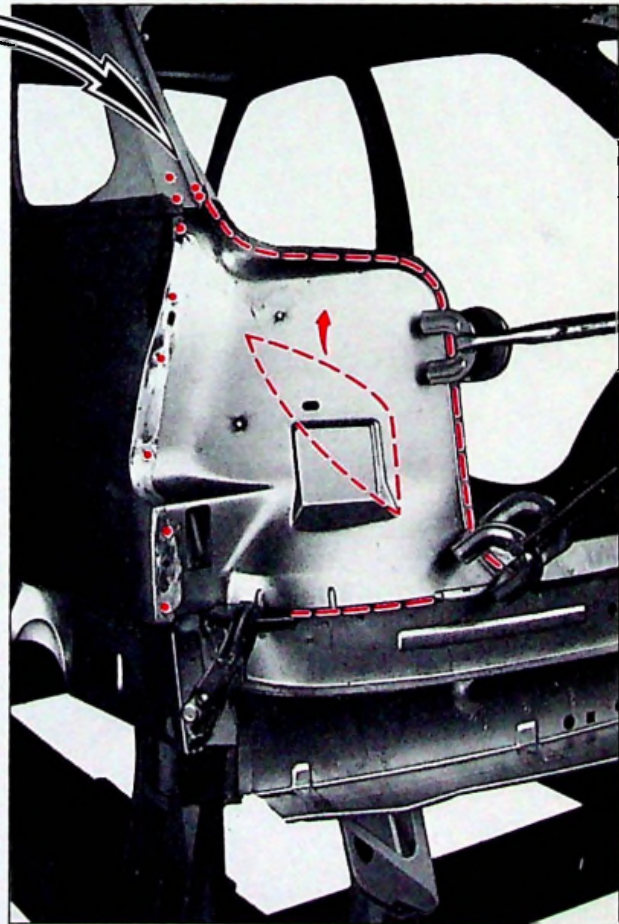
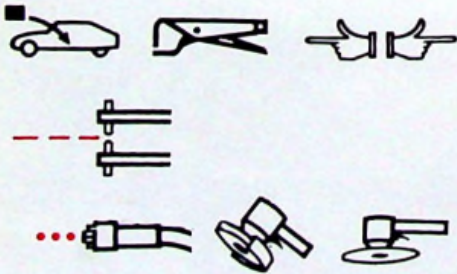

90-1661



14

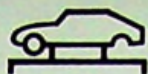

ZX
831-3/1

9

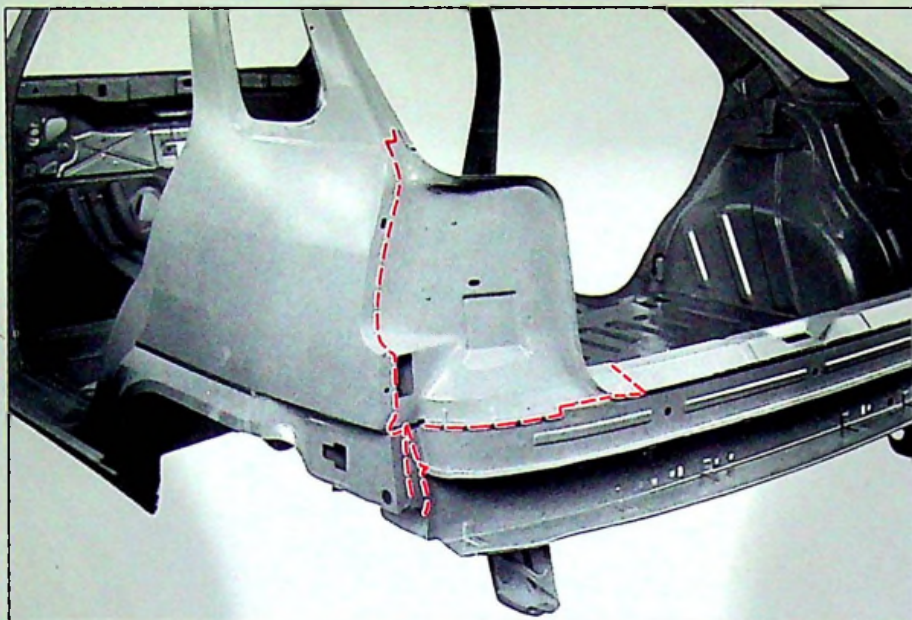

90-964

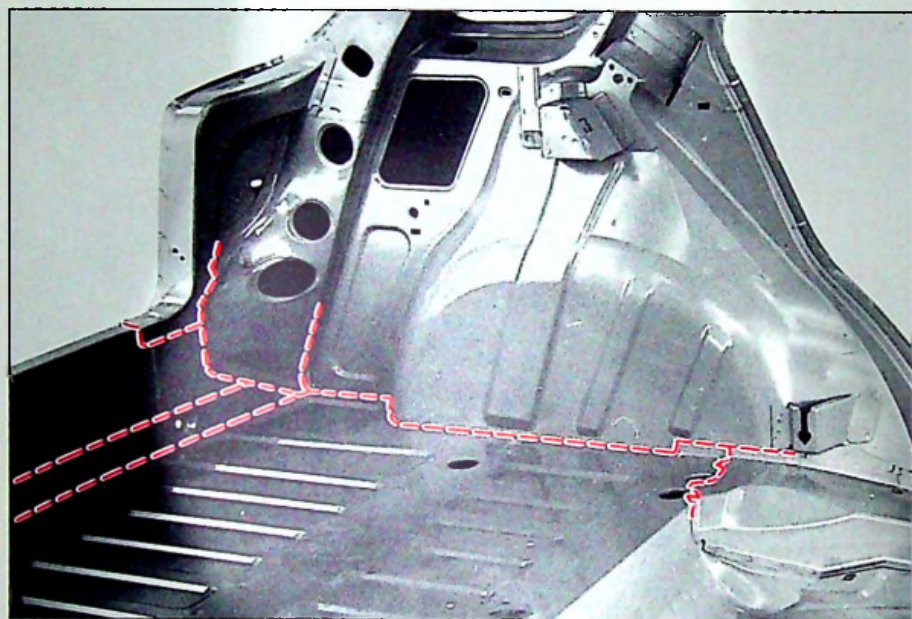

90-1099

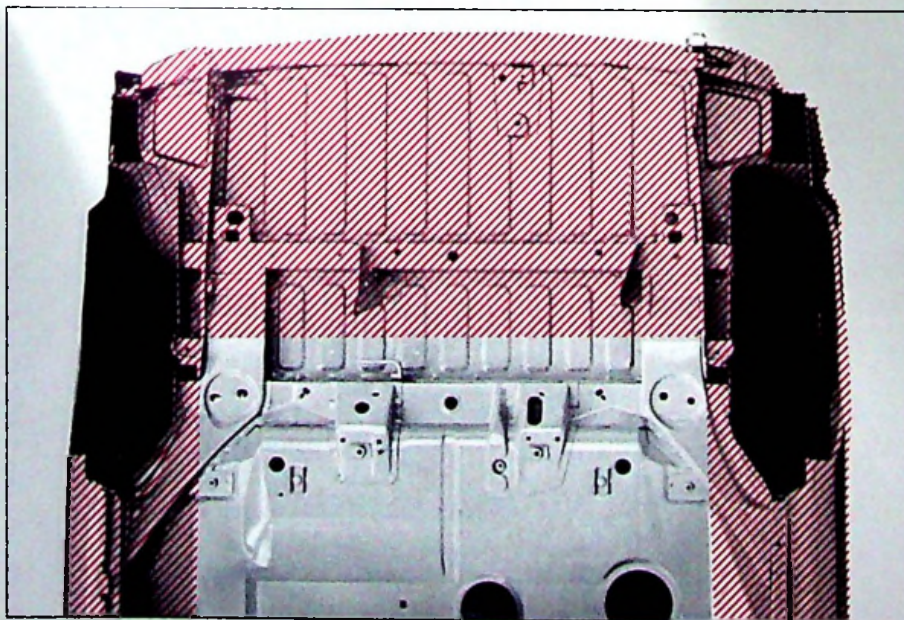

90-1070

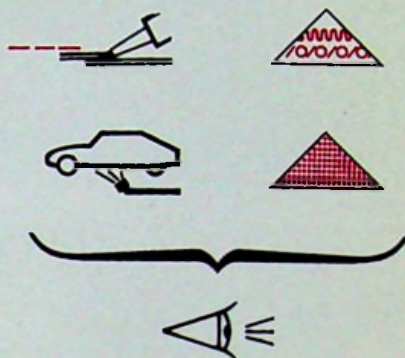

ZX 000-00/5

ZX 800-00/3

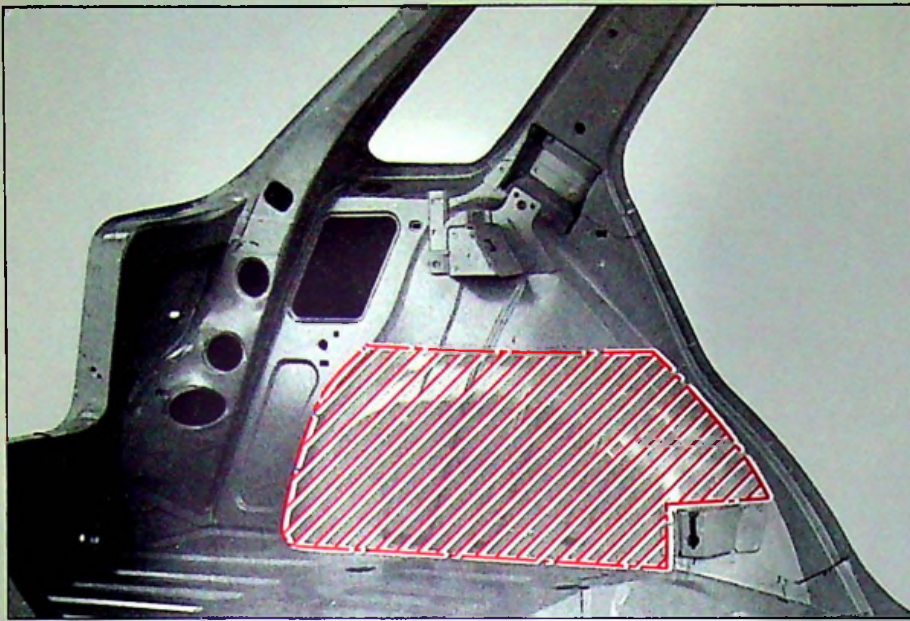
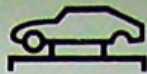

90-1098

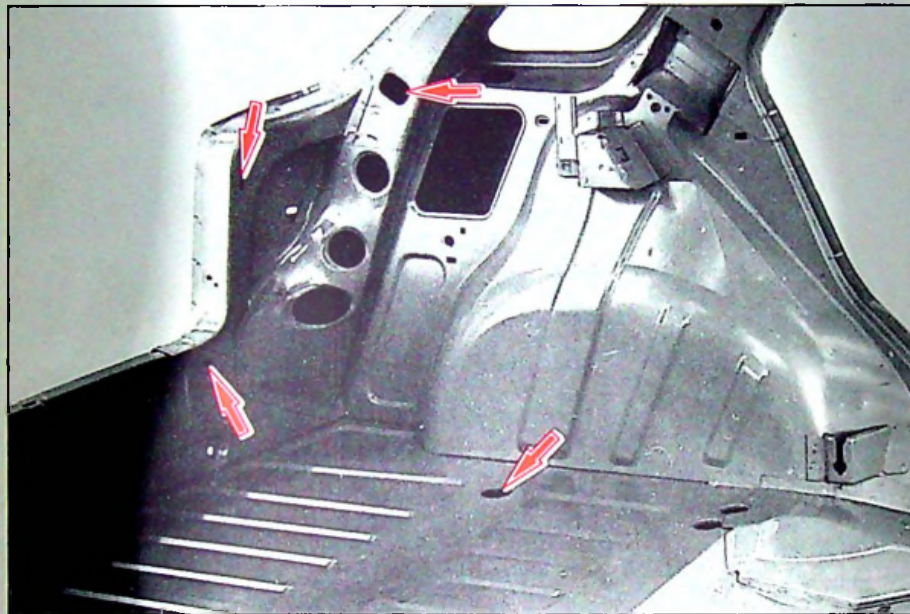

90-1099

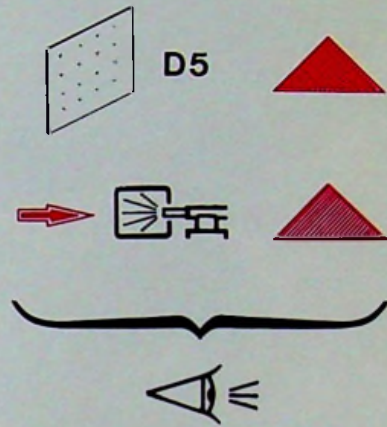

ZX 000-00/5
ZX 800-00/3



90-960



14

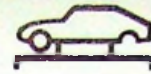

ZX
831-3/3

1

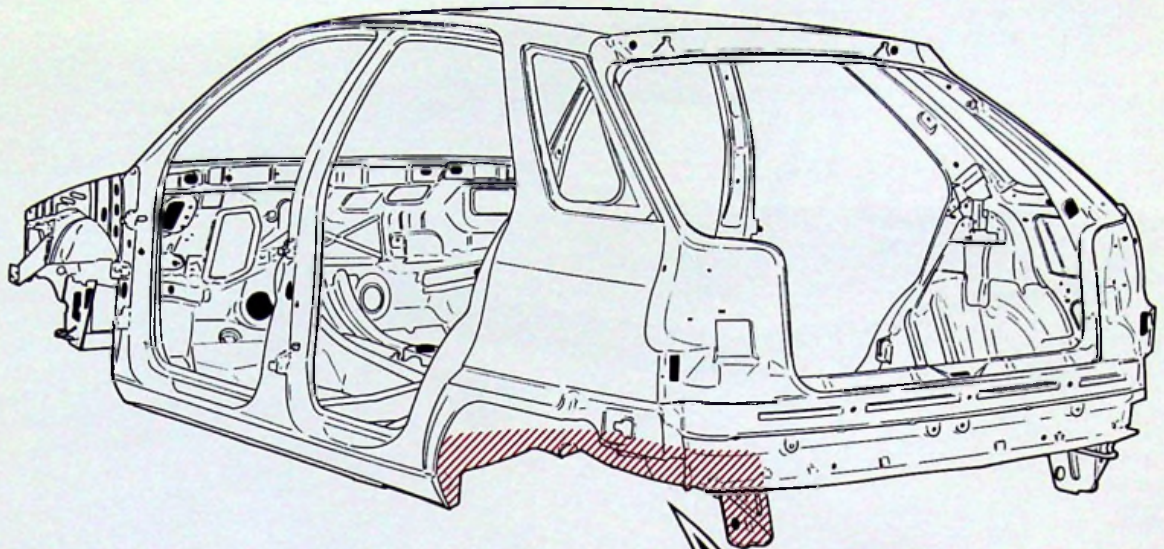

F.80-11



91-746

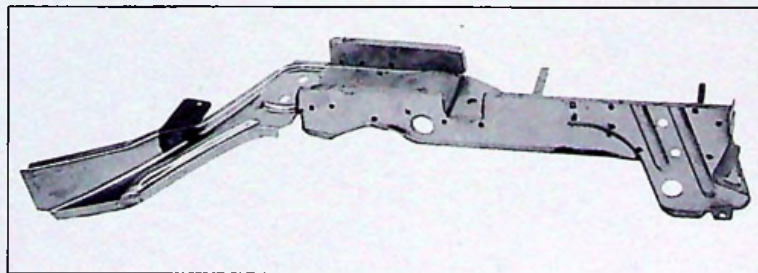

90-1120

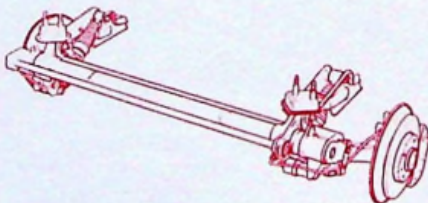
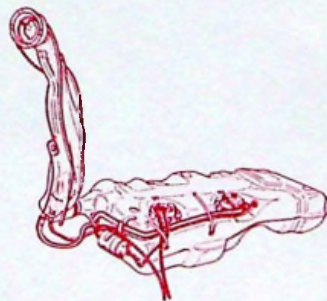
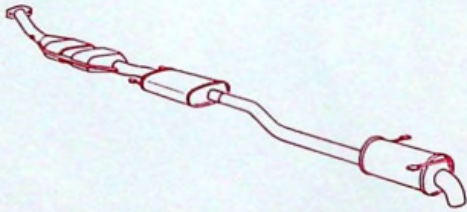
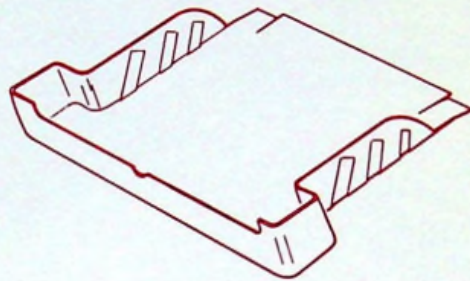
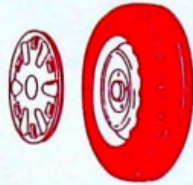
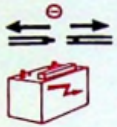
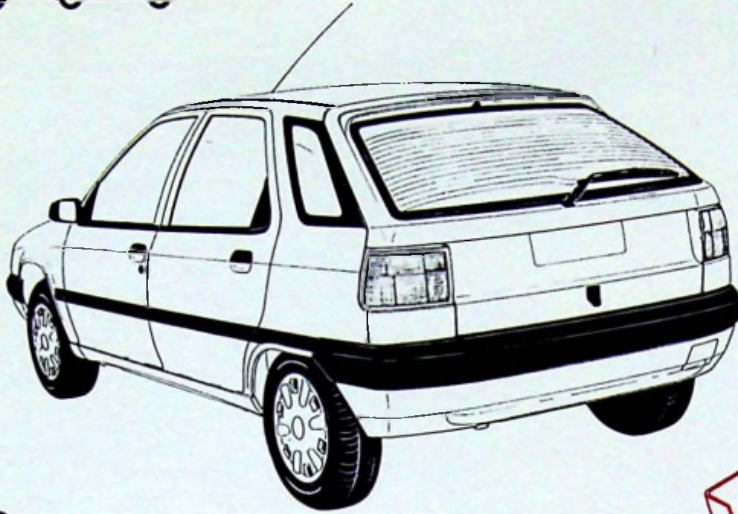
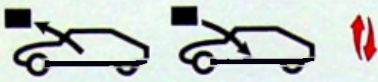

- F. 17-3
- F. 42-5
- F. 80-13
- F. 80-19
- F. 80-20
- F. 80-28



14

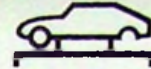

ZX
831-3/3

3

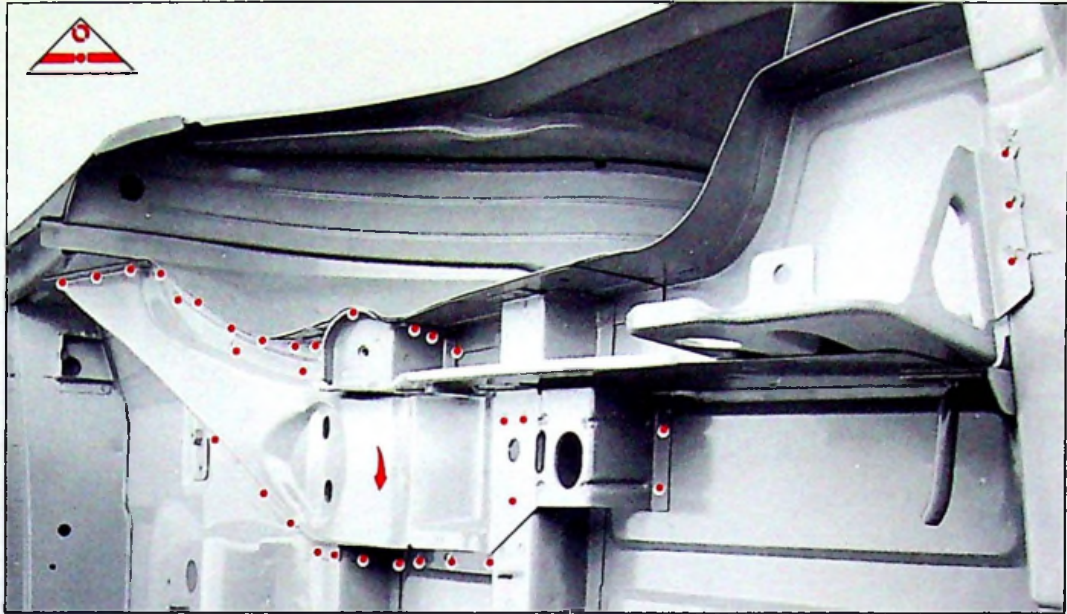

90-1072

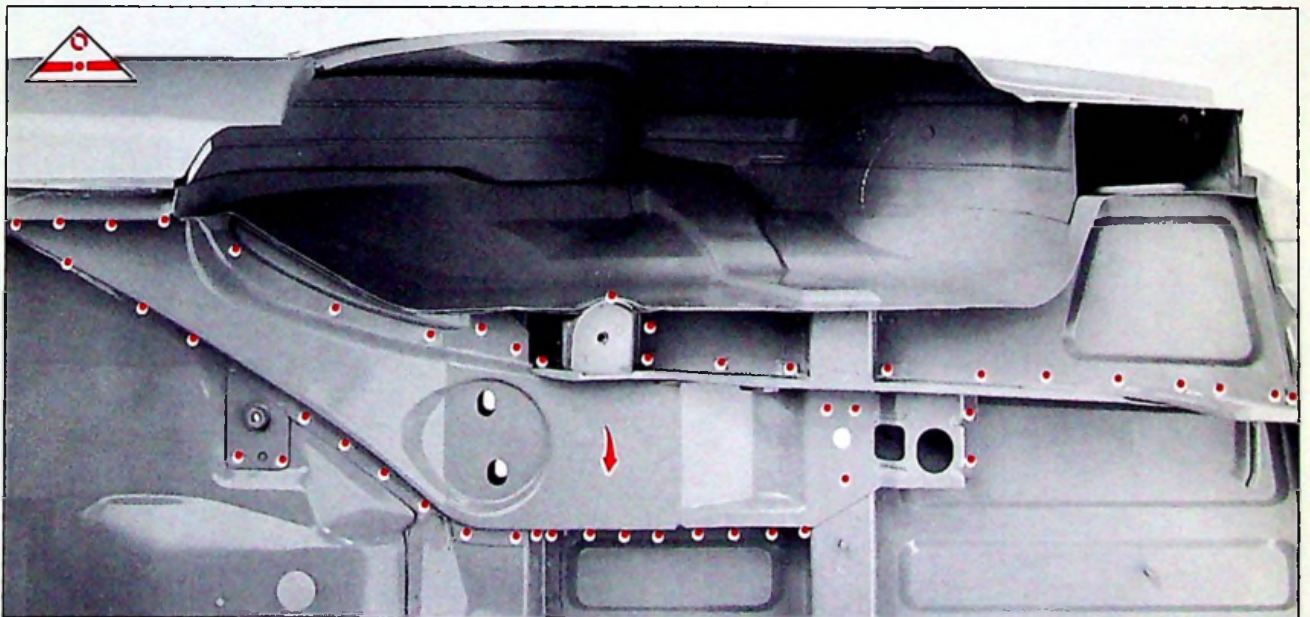
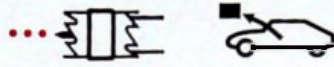

90-1064

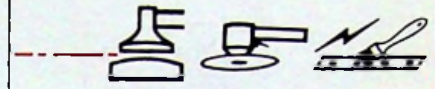
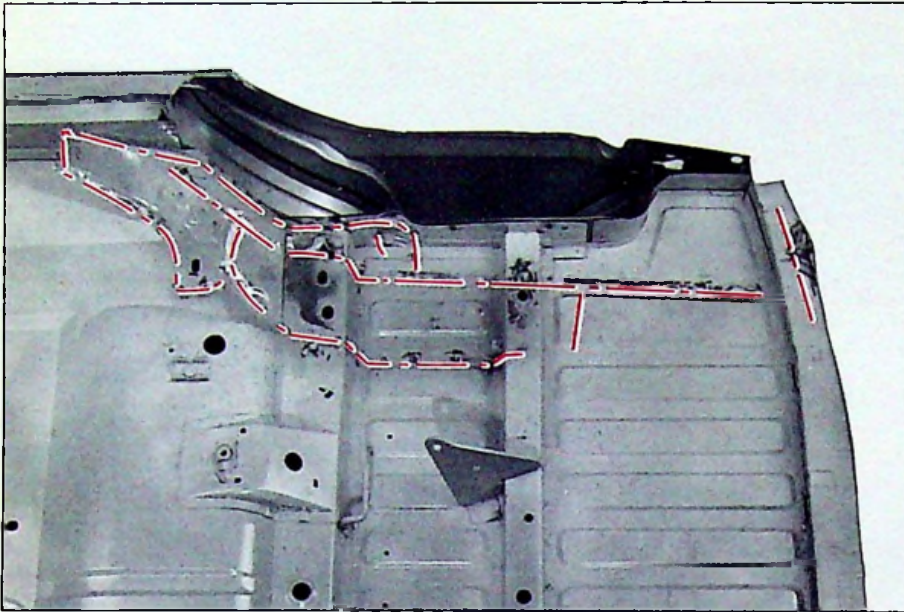

91-748

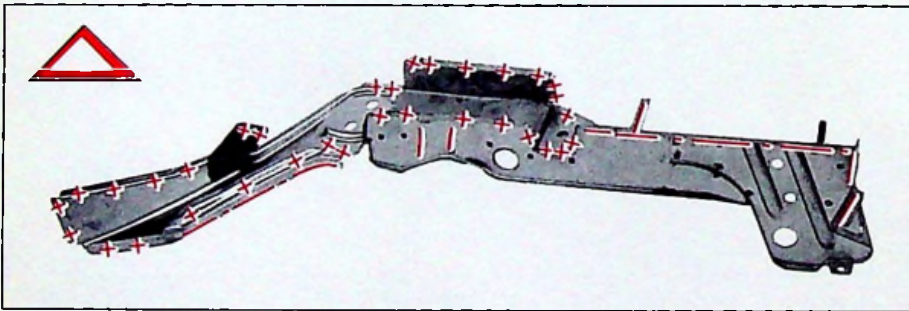

90-1120

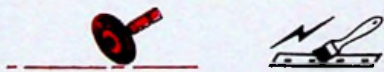

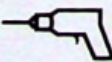
+++  Ø = 6 mm

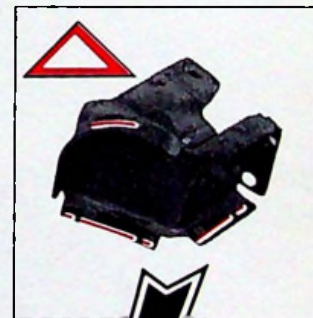

91-746

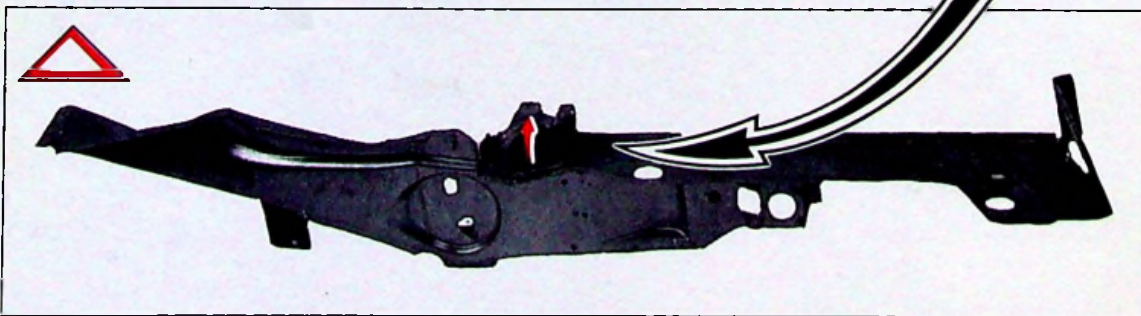
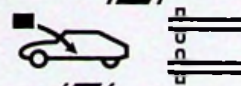

91-747



14



ZX
831-3/3

5

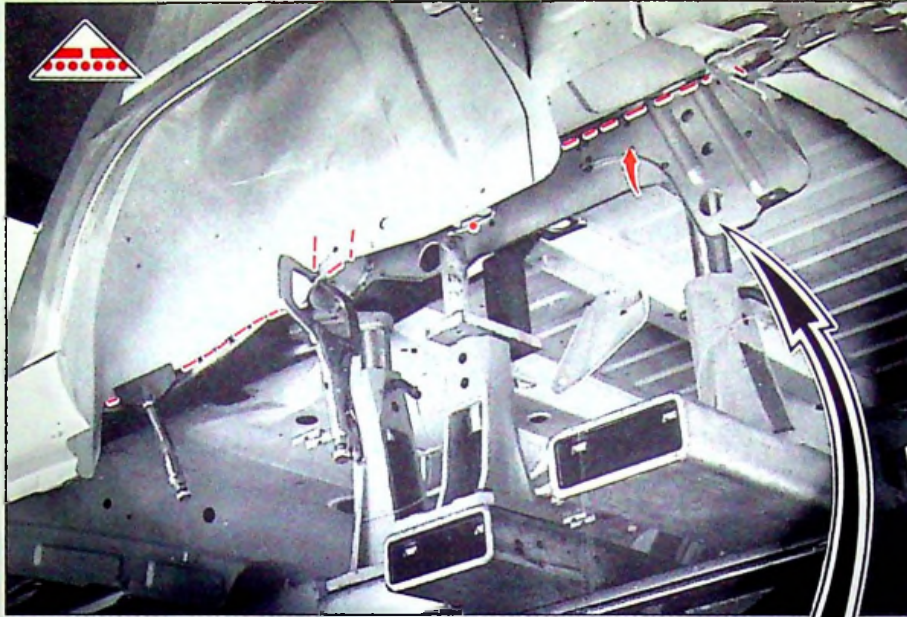

91-749

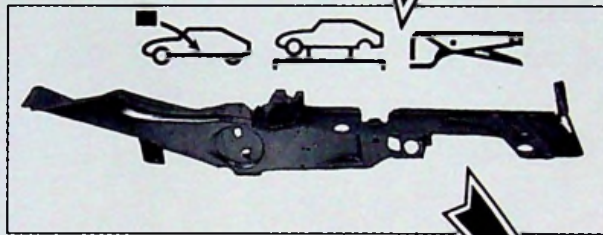
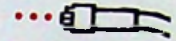
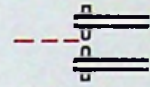

91-747

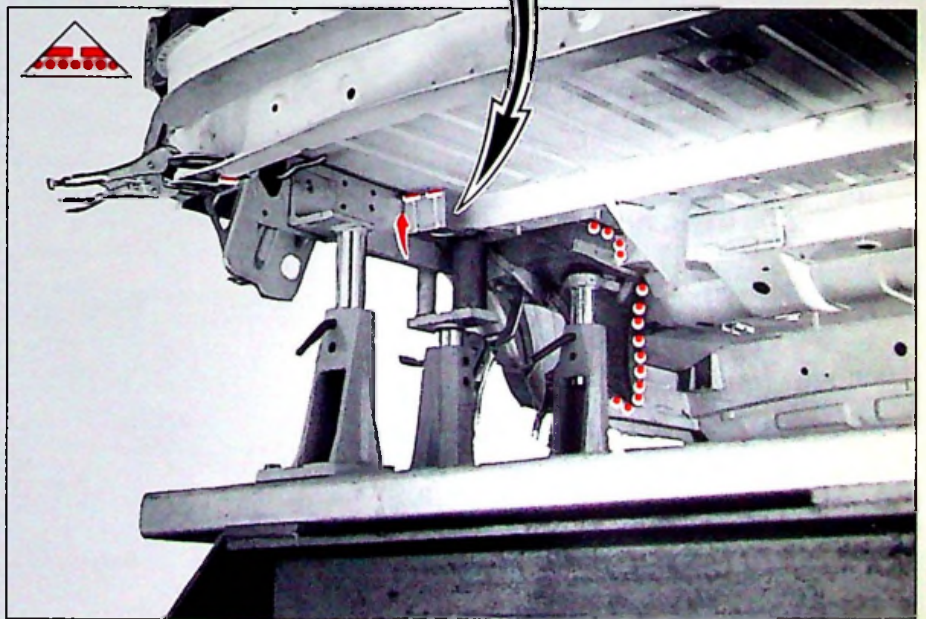
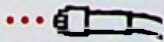
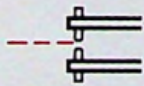

91-750

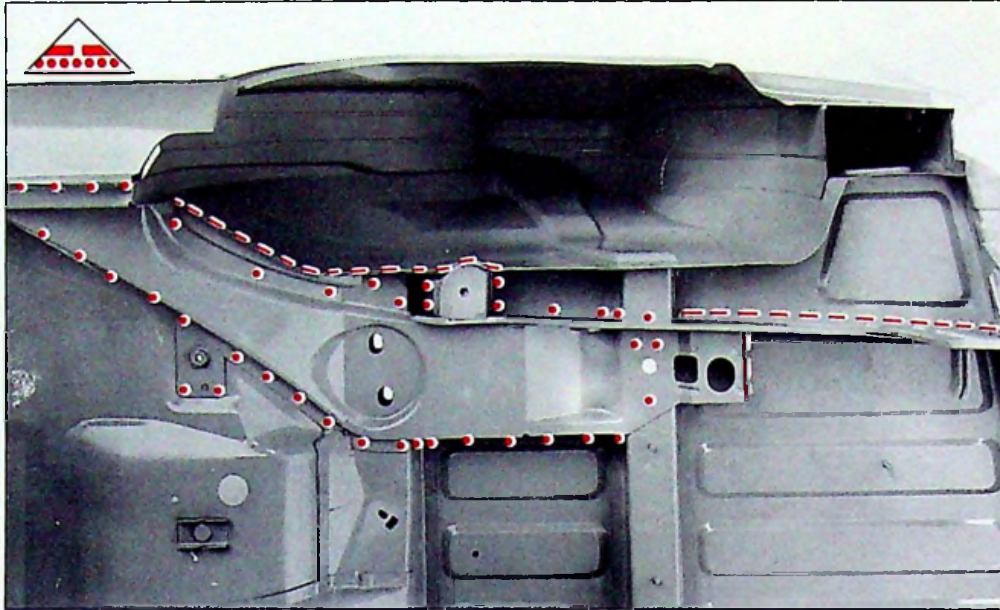

90-1064

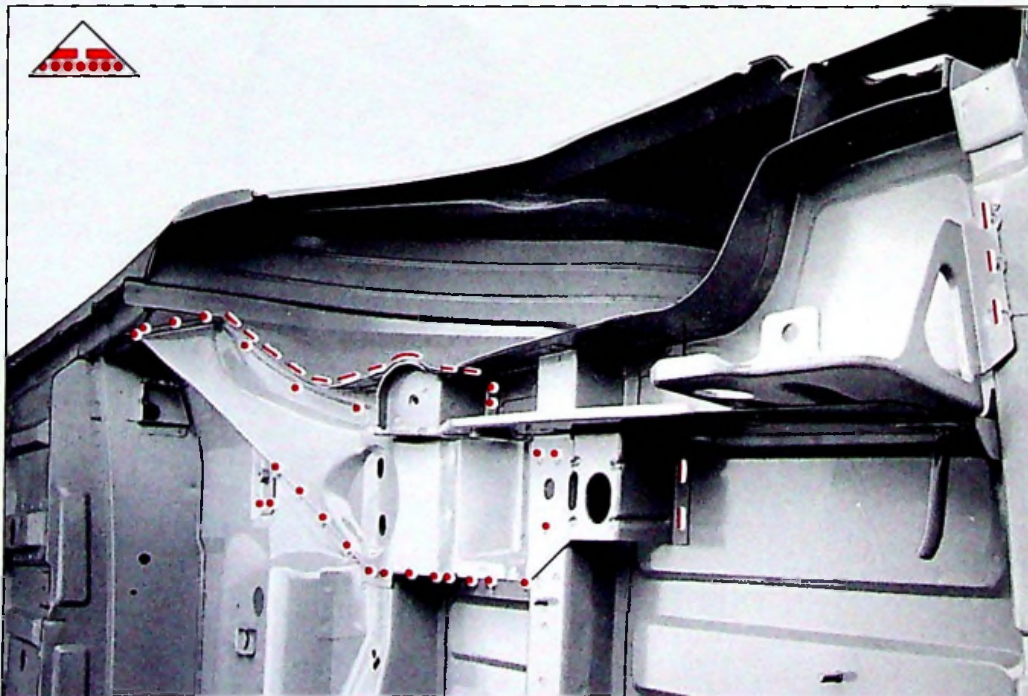
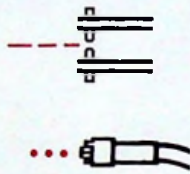

90-1072



14



ZX
831-3/3

7

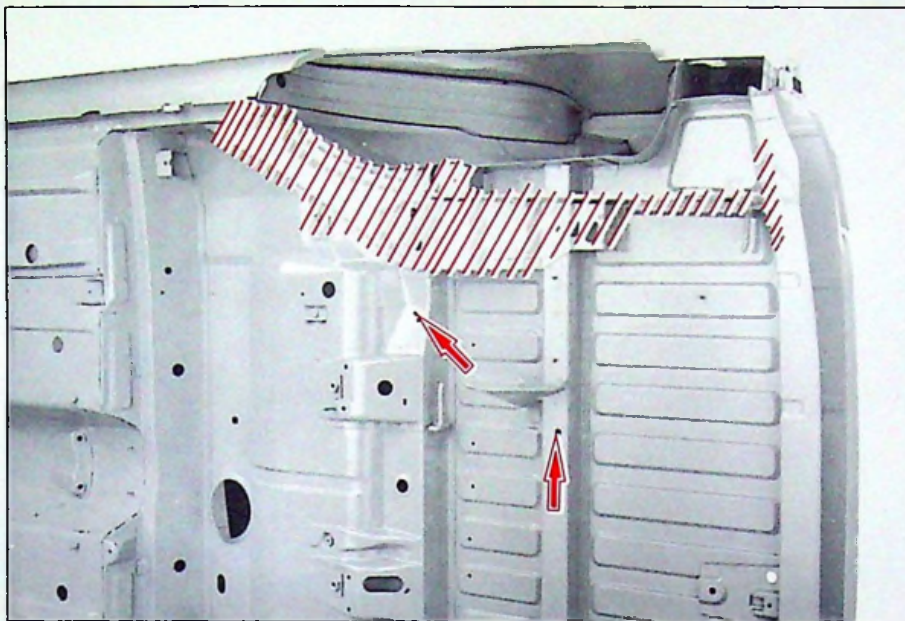

90-1067

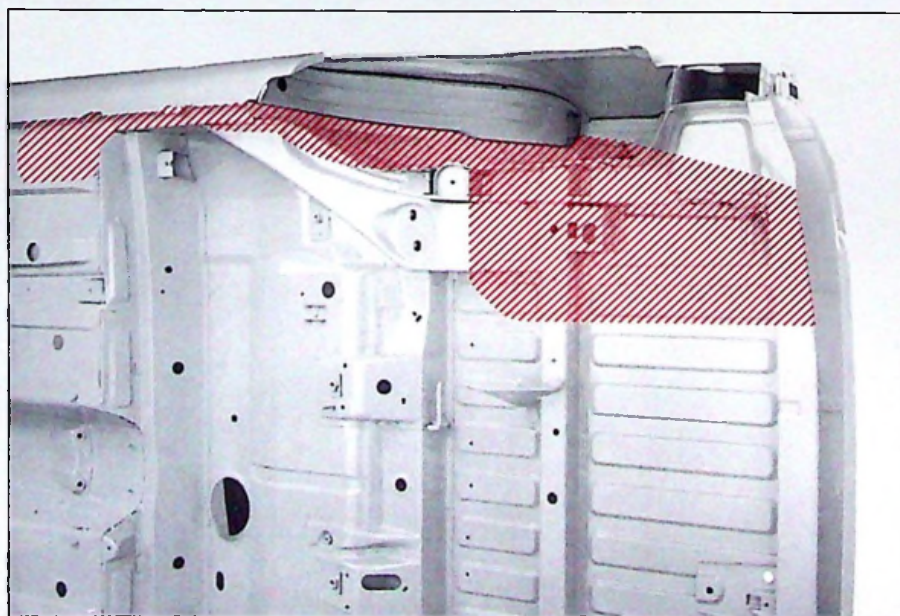
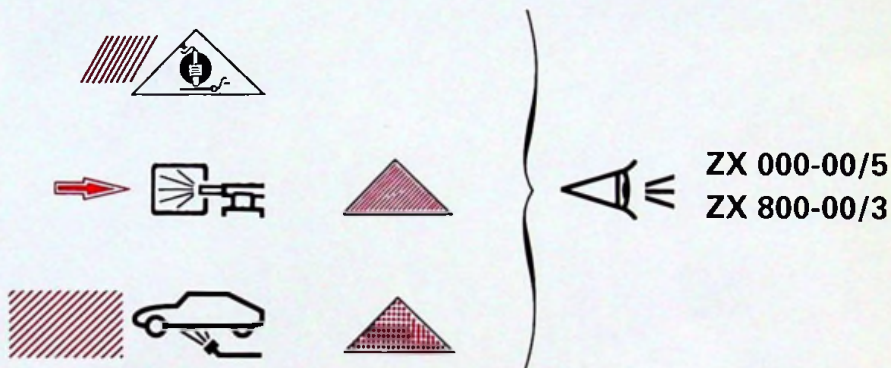

90-1067

CITROËN ZX

LE 31 OCTOBRE 1995

ABONNEMENT CAR

RÉF.

14

N° ZX-1



STRUCTURE

● EVOLUTION :

- Soubassement de caisse.
- Tapis et insonorisant.
- Faisceau d'habitacle.
- Canalisations de freins arrière.
- Canalisations carburant.

MAN 008943

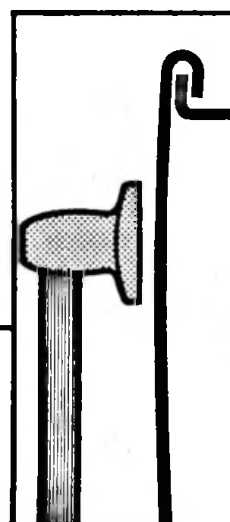

AUTOMOBILES CITROËN
DIRECTION COMMERCE EUROPE
DOCUMENTATION APRÈS VENTE

EVOLUTION : STRUCTURE CAISSE

Application depuis le numéro d'OPR : 6916.

Véhicule concerné : CITROEN ZX 3; 5 portes ; break.

1 - CARROSSERIE

Concerne :

- soubassement de caisse
- tapis et insonorisant
- faisceau d'habitacle
- canalisations de freins arrière
- canalisations carburant

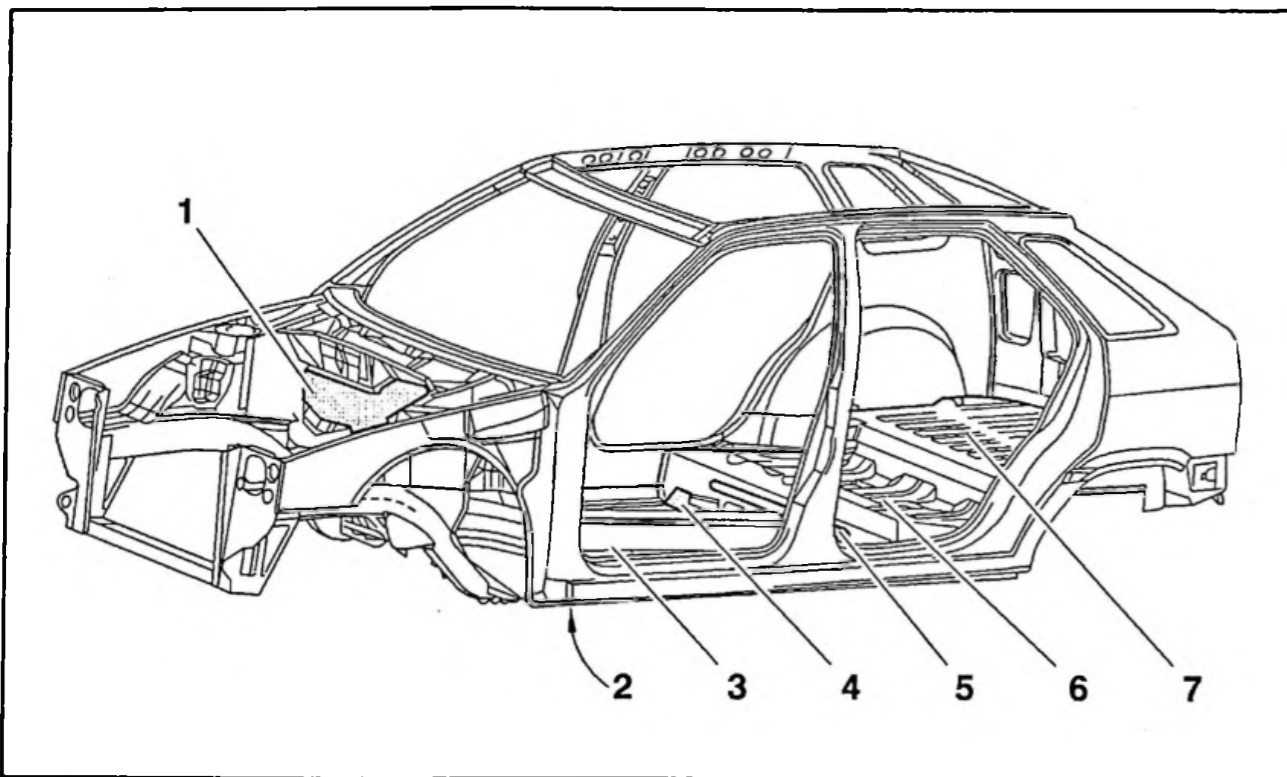

Fig : C4EP083D

1.1 - Tablier (1)

Evolution des nervurages (sans incidence "après vente").

1.2 - Brancards arrière extérieurs sous plancher (2)

Evolution des emboutis sur les brancards extérieurs (suite au nouveau plancher).

1.3 - Plancher avant (3)

Nouvelles géométrie des emboutissages.

1.4 - Plancher sous les assises arrière (4)

Augmentation du diamètre de l'orifice d'accès à la pompe de carburant (156 mm, au lieu de 142 mm).

Adjonction de 2 équerres de renfort (4) (entre la planche à talon et le plancher avant).

Emboutis dans la planche à talon (5) (pour recevoir le faisceau d'habitacle).

1.5 - Plancher de coffre (7)

Evolution des nervurages.

1.6 - Traverse sous planche à talon

Evolution suite à l'augmentation du diamètre du puits d'aspiration.

2 - HABILLAGE

2.1 - Tapis d'habitacle

Le tapis d'habitacle se compose de 2 parties au lieu d'une seule (une partie avant + une partie arrière).

Le tapis d'habitacle est adapté à la nouvelle géométrie du plancher (insonorisant intégré au tapis).

Le tapis d'habitacle remonte jusqu'à la planche de bord, au niveau des pieds avant (suppression de la garniture).

2.2 - Cale repose pieds

Création d'une cale sous le tapis au niveau des pieds du passager.

2.3 - Insonorisant de tablier

Evolution de l'insonorisant de tablier (suite à la fixation de la cale repose pieds).

2.4 - Tapis de coffre

Nouveau tapis de coffre adapté à la nouvelle géométrie du plancher (insonorisant intégré au tapis).

3 - EVOLUTIONS ELECTRICITE

3.1 - Faisceau d'habitacle

Récapitulatif des évolutions :

- parcours du faisceau d'habitacle
- goulotte de cheminement du faisceau électrique
- déplacement du connecteur du boîtier de prétentionneur

3.2 - Boîtier de prétentionneur

Raccourcissement du faisceau électrique.

4 - EVOLUTIONS MECANIQUES

4.1 - Canalisations carburant

Changement de matière (rilsan au lieu de métallique).

Cheminement des canalisations adapté à la nouvelle géométrie du plancher.

Version essence :

- diminution du diamètre de la canalisation d'alimentation (6/8 mm, au lieu de 8/10 mm)
- inversion de l'implantation des canalisations de retour réservoir et de retour caniter (le retour réservoir est coté intérieur au lieu d'extérieur)

4.2 - Canalisations de freins arrière

Cheminement des canalisations adapté à la nouvelle géométrie du plancher.

5 – REPARATION

5.1 – Identification des pièces de rechange

Désignation	Nouvelles pièces	Nouvelles pièces (remplaçant les anciennes pièces)	Anciennes pièces (pièces conservées)
Tapis d'habitacle (insonorisant intégré au tapis)	x		
Tapis de coffre (insonorisant intégré au tapis)	x		
Faisceau d'habitacle	x		
Canalisations carburant			
Alimentation d'essence : Ø = 6/8 mm	x		
Alimentation en gazole : Ø = 8/10 mm	x		
Retour carburant : Ø = 6/8 mm	x		
Canister : Ø = 6/8 mm	x		
Canalisations de freins arrière	x		
Caisse nue	x	x	
Brancards avant (assemblés)	x	x	
Tabliers supérieur (assemblés)	x	x	
Plancher de coffre (assemblés)	x	x	
Insonorisant de tablier	x	x	
Brancards arrière			x
Tapis d'habitacle (sans insonorisant)			x
Tapis de coffre (sans insonorisant)			x
Faisceau d'habitacle			x
Canalisations carburant (métallique)			x
Canalisations de freins arrière			x

5.2 – Méthodologie

5.2.1 – Echange d'une caisse

Le service des pièces de rechange ne commercialise plus que des nouvelles pièces.

L'échange d'une caisse sur un véhicule "ancienne caisse" nécessite de "demander en outre" (D.e.o) les nouveaux éléments suivants :

- tapis d'habitacle (une partie avant + une partie arrière)
- cale repose pieds
- obturateur accès pompe à carburant
- canalisations de freins arrière (sous caisse)
- canalisations carburant (sous caisse) : pour les versions essence, utiliser la canalisation d'alimentation de la version gazole (Ø 8/10 mm)

NOTA : Protéger le faisceau électrique au niveau des nouveaux renforts sur la planche à talon.

5.2.2 – Echange d'un brancard avant

Le service des pièces de rechange ne commercialise plus que des nouvelles pièces (8)+(2).

Le brancard arrière (9) ancienne génération reste commercialisé.

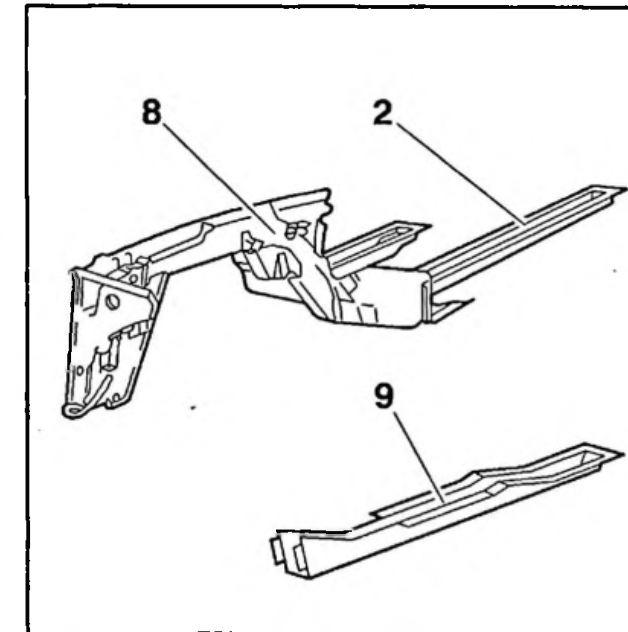

Fig : C4EP084C

Sur un véhicule "ancienne caisse", le changement d'un brancard avant assemblé nécessite de remplacer la pièce (2) par la pièce (8).

5.2.3 – Echange d'un plancher de coffre

Le service des pièces de rechange ne commercialise plus que des nouvelles pièces.

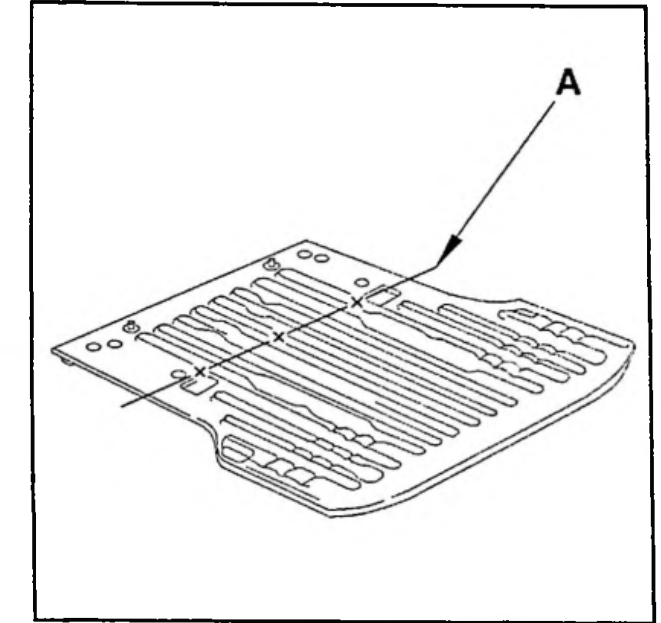

Fig : C4EP085C

La découpe partielle bord à bord suivant l'axe "A" devient impossible sur un ancien plancher (nervurage différent).

Lors d'un choc arrière :

- retirer la partie du plancher endommagée
- poser l'intégralité du nouveau plancher sur la partie restante de l'ancien
- appliquer une colle structurale entre les éléments
- souder par points bouchons MAG
- réaliser l'étanchéité sous caisse entre les deux planchers à l'aide de mastics préformés ou extrudables

L'ancien tapis de coffre se monte sur le nouveau plancher.

CITROËN ZX

MARS 1998

OPR : 7784 →

RÉF.

14

N° ZX-2



STRUCTURE

VERSION CITROËN ZX BREAK

- **EVOLUTION :**
- Plancher arrière assemblé.

MAN 008943

"Les Informations techniques contenues dans la présente documentation sont destinées exclusivement aux professionnels de la réparation automobile. Dans certains cas, ces informations peuvent concerner la sécurité des véhicules. Elles seront utilisées par les réparateurs automobiles auxquels elles sont destinées, sous leur entière responsabilité, à l'exclusion de celle du Constructeur".

"Les informations techniques figurant dans cette brochure peuvent faire l'objet de mises à jour en fonction de l'évolution des caractéristiques des modèles de chaque gamme. Nous invitons les réparateurs automobiles à se mettre en rapport périodiquement avec le réseau du Constructeur, pour s'informer et se procurer les mises à jour nécessaires".

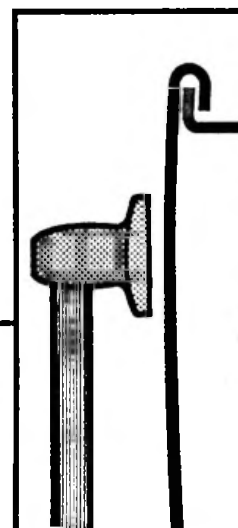

AUTOMOBILES CITROËN
DIRECTION EXPORT EUROPE
DOCUMENTATION APRÈS VENTE

EVOLUTION : PLANCHER ARRIERE ASSEMBLE

1 - APPLICATION

Véhicule concerné : CITROEN ZX break.
Depuis le N° OPR 7784.

2 - PIECES DE RECHANGE

Plancher arrière assemblé livré sans anneau de remorquage soudé (avec changement de référence).
Création de l'anneau de remorquage (livré au détail).
NOTA : En après-vente, souder l'anneau de remorquage sur l'appui de remorquage.

3 - ADAPTATION

IMPERATIF : Toutes les surfaces découpées doivent être protégées par le procédé de zéngage électrolytique homologué ; référence : C8.

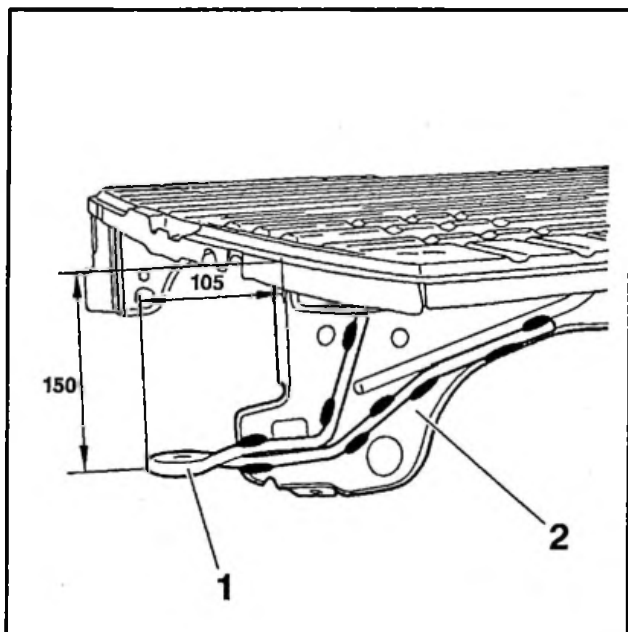

Fig : C4BP14HC

Poser l'anneau de remorquage (1) sur l'appui de remorquage (2).
Souder par cordon MAG.

4 - PROTECTION

IMPERATIF : Les zones usinées doivent être peintes en apprêt puis couleur du support.