



67



XM
670-000/1

1

FONCTION : OUVRANTS

NOMENCLATURE DES PIECES
LISTE DES SCHEMAS



67

NOMENCLATURE DES PIECES

XM
670-000/1

3

Rep.	Désignation	Fonct.	Rep.	Désignation	Fonct.
3	Afficheur gauche (afficheur électronique ou silhouette)	52	598	Interrupteur plafonnier	55
			607	Interrupteur toit ouvrant	67
			615	Interrupteur alarme (protection volumétrique)	67
35	Batterie	TT			
40	Bloc compteurs	52	696	Moteur de lève-vitre avant gauche	67
51	Boîtier de dérivation	TT*	697	Moteur de lève-vitre avant droit	67
52	Boîtier interconnexions	TT	698	Moteur de lève-vitre arrière gauche	67
55	Boîtier de verrouillage de portes	67	699	Moteur de lève-vitre arrière droit	67
58	Boîtier récepteur de verrouillage	67	702	Moteur de toit ouvrant	67
67	Boîtier alarme-antivol	67	703	Moteur de verrouillage porte conducteur	67
68	Boîtier rétroviseur électrique	56	704	Moteur de verrouillage porte passager	67
			705	Moteur de verrouillage porte arrière gauche	67
			706	Moteur de verrouillage porte arrière droite	67
163	Capteur volumétrique gauche	67	707	Moteur de verrouillage de trappe carburant	67
164	Capteur volumétrique droit	67	708	Moteur de verrouillage de volet arrière	67
			724	Motoréducteur de lève-vitre antipincement	67
176	Clavier antidémarrage codé	51	730	Moteur de supercondamnation porte avant gauche	67
			731	Moteur de supercondamnation porte avant droite	67
280	Connecteur diagnostic	TT	732	Moteur de supercondamnation porte arrière gauche	67
295	Contacteur de supercondamnation porte avant gauche	67	733	Moteur de supercondamnation porte arrière droite	67
296	Contacteur de supercondamnation porte avant droite	67			
297	Contacteur de supercondamnation porte arrière gauche	67	795	Relais alarme antivol	67
298	Contacteur de supercondamnation porte arrière droite	67			
300	Contacteur antivol	TT*	809	Relais lève-vitre avant	67
303	Contact fermeture gauche capot (témoin)	67	810	Relais lève-vitre arrière	67
304	Contact fermeture droit capot (témoin)	67			
305	Contact fermeture porte conducteur (témoin)	67	874	Relais d'alimentation toit ouvrant	67
306	Contact fermeture porte passager (témoin)	67			
307	Contact fermeture porte arrière gauche (témoin)	67	888	Sirène	67
308	Contact fermeture porte arrière droite (témoin)	67			
309	Contact fermeture de volet (témoin)	67	961	Temporisateur éclairage	55
310	Contact feuillure porte avant gauche	55			
311	Contact feuillure porte avant droite	55	991	Voyant alarme - antivol	67
312	Contact feuillure porte arrière gauche	55			
313	Contact feuillure porte arrière droite	55			
321	Contact de verrouillage volet	67			
323	Contact toit ouvrant (pt zéro)	67			
324	Contact toit ouvrant fin de course coulissement	67			
325	Contact toit ouvrant fin de course entrebâillement	67			
474	Ensemble serrure porte avant gauche	67			
475	Ensemble serrure porte avant droite	67			
476	Ensemble serrure porte arrière gauche	67			
477	Ensemble serrure porte arrière droite	67			
488	Feu de direction avant gauche	54			
489	Feu de direction avant droit	54			
490	Feu de direction arrière gauche	54			
491	Feu de direction arrière droit	54			
500	Feu répétiteur de direction gauche	54			
501	Feu répétiteur de direction droit	54			
583	Interrupteur condamnation fonction arrière	55-67			
590	Interrupteur lève-vitre conducteur	67			
591	Interrupteur lève-vitre passager (sur porte cond.)	67			
592	Interrupteur lève-vitre passager (sur porte pass.)	67			
593	Interrupteur lève-vitre arrière gauche sur porte	67			
594	Interrupteur lève-vitre arrière gauche sur console	67			
595	Interrupteur lève-vitre arrière droit sur porte	67			
596	Interrupteur lève-vitre arrière droit sur console	67			

4

XM
670-000/1CHAPITRE OUVRANTS
LISTE DES SCHEMAS

67



RAPPEL

Pour tous les schémas, la fonction électrique est représentée :

- véhicule à l'arrêt,
- clef de contact sur la position "0",
- les issues (portes, volet, trappe à carburant...) sont fermées mais non verrouillées,
- vitres relevées et toit ouvrant fermé,
- et il n'y a aucune action manuelle, mécanique, ou autre, en cours.

COMMANDE LEVE-VITRES

NUMERO	DIRECTION	VALIDITE	DESIGNATION
671-1/10	Gauche	6383 → → 6749	TOUS TYPES Lève-vitres AVANT XMA54
671-1/10a	Gauche	6749 → → 7329	Evolution a : Modif. Evolution boîte fusibles XMS200
671-1/10b	Gauche	7329 →	Evolution b : Evolution faisceau PB XMP022
671-1/20	Gauche	6383 → → 6749	TOUS TYPES Lève-vitres AVANT séquentiels et anti-pincement XMA55
671-1/20a	Gauche	6749 → → 7329	Evolution a : Modif. Evolution boîte fusibles XMS201
671-1/20b	Gauche	7329 →	Evolution b : Evolution faisceau PB XMP023
671-1/50	Gauche	6383 → → 6749	TOUS TYPES Lève-vitres ARRIERE XMA56
671-1/50a	Gauche	6749 → → 7084	Evolution a : Modif. Evolution boîte fusibles XMS204
671-1/50b	Gauche	7084 → → 7329	Evolution b : Evolution faisceau CL XMP007
671-1/50c	Gauche	7329 → → 7483	Evolution c : Evolution faisceaux PB et CL XMP024
671-1/50d	Gauche	7483 →	Evolution d : Suppression d'une variante
671-1/55	Gauche	6383 → → 6749	BREAK VAREBILER (NORVEGE) Lève-vitres ARRIERE XMA72
671-1/55a	Gauche	6749 → → 7084	Evolution a : Modif. Evolution boîte fusibles XMS205
671-1/55b	Gauche	7084 → → 7329	Evolution b : Evolution faisceau CL XMP008
671-1/55c	Gauche	7329 →	Evolution c : Evolution faisceaux PB et CL XMP025
671-2/10	Droite	6383 → → 6749	TOUS TYPES Lève-vitres AVANT XMA69
671-2/10a	Droite	6749 → → 7329	Evolution a : Modif. Evolution boîte fusibles XMS202
671-2/10b	Droite	7329 →	Evolution b : Evolution faisceau PB XMP026



67

XM
670-000/1

5

COMMANDE LEVE-VITRES (suite)

NUMERO	DIRECTION	VALIDITE	DESIGNATION
671-2/20	Droite	6383 → → 6749	TOUS TYPES Lève-vitres AVANT séquentiels et anti-pincement XMA70
671-2/20a	Droite	6749 → → 7329	Evolution a: Modif. Evolution boîte fusibles XMS203
671-2/20b	Droite	7329 →	Evolution b : Evolution faisceau PB XMP027
671-2/50	Droite	6383 → → 6749	TOUS TYPES Lève-vitres ARRIERE XMA71
671-2/50a	Droite	6749 → → 7084	Evolution a: Modif. Evolution boîte fusibles XMS206
671-2/50b	Droite	7084 → → 7329	Evolution b : Evolution faisceau CL XMP009
671-2/50c	Droite	7329 → → 7483	Evolution c : Evolution faisceaux PB et CL XMP028
671-2/50d	Droite	7483 →	Evolution d : Suppression d'une variante XMP043

COMMANDE FERMETURE PORTES

NUMERO	DIRECTION	VALIDITE	DESIGNATION
672-1/10	Gauche	6383 → → 6749	VEHICULE SANS COMMANDE A DISTANCE Condamnation centralisée XMA57
672-1/20	Gauche	6383 → → 7084	VEHICULE SANS AFFICHEUR GAUCHE Condamnation centralisée à commande à distance XMA59
672-1/20a	Gauche	7084 → → 7168	Evolution a : Plip H.F. ald plip I.R. XMP010
672-1/20b	Gauche	7168 → → 7483	Evolution b : Evolution faisceaux PB et VD XMP029
672-1/30	Gauche	6383 → → 7084	VEHICULE AVEC AFFICHEUR GAUCHE ET SANS LEVE-VITRES ARRIERE Condamnation centralisée à commande à distance XMA61
672-1/30a	Gauche	7084 → → 7168	Evolution a : Plip H.F. ald plip I.R. XMP011
672-1/30b	Gauche	7168 → → 7483	Evolution b : Evolution faisceaux PB, CL et VD XMP030
672-1/30c	Gauche	7483 → → 8028	Evolution c : Evolution du faisceau PB, suppression du faisceau PA XMP044
672-1/30d	Gauche	8028 →	Evolution d : Evolution du faisceau PB XMP048



COMMANDE FERMETURE PORTES (suite)

NUMERO	DIRECTION	VALIDITE	DESIGNATION
672-1/40	Gauche	6383 → → 7084	VEHICULE AVEC AFFICHEUR GAUCHE ET AVEC LEVE-VITRES ARRIERE Condamnation centralisée à commande à distance XMA63
672-1/40a	Gauche	7084 → → 7168	Evolution a : Plip H.F. ald plip I.R. XMP012
672-1/40b	Gauche	7168 → → 7483	Evolution b : Evolution faisceaux PB, CL et VD XMP031
672-1/40c	Gauche	7483 → → 8028	Evolution c : Evolution du faisceau PB, suppression du faisceau PA XMP045
672-1/40d	Gauche	8028 →	Evolution d : Evolution du faisceau PB XMP049
672-1/40d	Gauche	6383 → → 6749	VEHICULE SANS LEVE-VITRES ARRIERE Super-condamnation (avec émetteur/récepteur H.F.) XMA65
672-1/50a	Gauche	6749 → → 6947	Evolution a : Modif. Evolution boîte fusibles XMS207
672-1/50b	Gauche	6947 → → 7084	Evolution b : Evolution faisceau PA XMP001
672-1/50c	Gauche	7084 → → 7168	Evolution c : Evolution faisceaux PB, PA et FA XMP013
672-1/50d	Gauche	7168 → → 7483	Evolution d : Evolution faisceaux PB, CL et VD XMP032
672-1/60	Gauche	6383 → → 6749	VEHICULE AVEC LEVE-VITRES ARRIERE Super-condamnation (avec émetteur/récepteur H.F.) XMA66
672-1/60a	Gauche	6749 → → 6947	Evolution a : Modif. Evolution boîte fusibles XMS208
672-1/60b	Gauche	6947 → → 7084	Evolution b : Evolution faisceau PA XMP002
672-1/60c	Gauche	7084 → → 7168	Evolution c : Evolution faisceaux PB, PA et FA XMP014
672-1/60d	Gauche	7168 → → 7483	Evolution d : Evolution faisceaux PB, CL et VD XMP033
672-2/10	Droite	6383 → → 6749	VEHICULE SANS COMMANDE A DISTANCE Condamnation centralisée XMA58
672-2/20	Droite	6383 → → 7084	VEHICULE SANS AFFICHEUR GAUCHE Condamnation centralisée à commande à distance XMA60
672-2/20a	Droite	7084 → → 7168	Evolution a : Plip H.F. ald plip I.R. XMP015
672-2/20b	Droite	7168 → → 7483	Evolution b : Evolution faisceaux PB et VD XMP034



67

XM
670-000/1

7

COMMANDE FERMETURE PORTES (suite)

NUMERO	DIRECTION	VALIDITE	DESIGNATION
672-2/30	Droite	6383 → → 7084	VEHICULE AVEC AFFICHEUR GAUCHE ET SANS LEVE-VITRES ARRIERE Condamnation centralisée à commande à distance XMA62
672-2/30a	Droite	7084 → → 7168	Evolution a : Plip H.F. ald plip I.R. XMP016
672-2/30b	Droite	7168 →	Evolution b : Evolution faisceaux PB, CL et VD XMP035
672-2/40	Droite	6383 → → 7084	VEHICULE AVEC AFFICHEUR GAUCHE ET AVEC LEVE-VITRES ARRIERE Condamnation centralisée à commande à distance XMA64
672-2/40a	Droite	7084 → → 7168	Evolution a : Plip H.F. ald plip I.R. XMP017
672-2/40b	Droite	7168 → → 8028	Evolution b : Evolution faisceaux PB, CL et VD XMP036
672-2/40c	Droite	8028 →	Evolution c : Evolution du faisceau PB XMP050
672-2/50	Droite	6383 → → 6749	VEHICULE SANS LEVE-VITRES ARRIERE Super-condamnation (avec émetteur/récepteur H.F.) XMA67
672-2/50a	Droite	6749 → → 6947	Evolution a : Modif. Evolution boîte fusibles XMA209
672-2/50b	Droite	6947 → → 7084	Evolution b : Evolution faisceau PA XMP003
672-2/50c	Droite	7084 → → 7168	Evolution c : Evolution faisceaux PB, PA et FA XMP018
672-2/50d	Droite	7168 → → 7483	Evolution d : Evolution faisceaux PB, CL et VD XMP037
672-2/50e	Droite	7483 →	Evolution e : Nouvel interrupteur plafonnier XMP046
672-2/60	Droite	6383 → → 6749	VEHICULE AVEC LEVE-VITRES ARRIERE Super-condamnation (avec émetteur/récepteur H.F.) XMA68
672-2/60a	Droite	6749 → → 6947	Evolution a : Modif. Evolution boîte fusibles XMA210
672-2/60b	Droite	6947 → → 7084	Evolution b : Evolution faisceau PA XMP004
672-2/60c	Droite	7084 → → 7168	Evolution c : Evolution faisceaux PB, PA et FA XMP019
672-2/60d	Droite	7168 → → 7483	Evolution d : Evolution faisceaux PB, CL et VD XMP038
672-2/60e	Droite	7483 →	Evolution e : Nouvel interrupteur plafonnier XMP047



COMMANDE TOIT OUVRANT

NUMERO	DIRECTION	VALIDITE	DESIGNATION
673-0/20	Tous Types	6383 → → 7329	TOUS TYPES Toit ouvrant XMA75
673-0/20a	Tous Types	7329 →	Evolution a : Evolution faisceau PB XMP039

ALARME

NUMERO	DIRECTION	VALIDITE	DESIGNATION
675-1/10	Gauche	6383 → → 6749	TOUS TYPES Alarme XMA73
675-1/10a	Gauche	6749 → → 6947	Evolution a : Modif. Evolution boîte fusibles XMS212
675-1/10b	Gauche	6947 → → 7084	Evolution b : Evolution faisceau PA XMP005
675-1/10c	Gauche	7084 → → 7329	Evolution c : Evolution faisceaux AV et FA XMP020
675-1/10d	Gauche	7329 → → 7483	Evolution d : Evolution faisceaux PB, CL et VD XMP040
675-2/10	Droite	6383 → → 6749	TOUS TYPES Alarme XMA74
675-2/10a	Droite	6749 → → 6947	Evolution a : Modif. Evolution boîte fusibles XMS211
675-2/10b	Droite	6947 → → 7084	Evolution b : Evolution faisceau PA XMP006
675-2/10c	Droite	7084 → → 7329	Evolution c : Evolution faisceaux AV et FA XMP021
675-2/10d	Droite	7329 →	Evolution d : Evolution faisceaux PB, CL et VD XMP041



67



XM
671-1/10

3

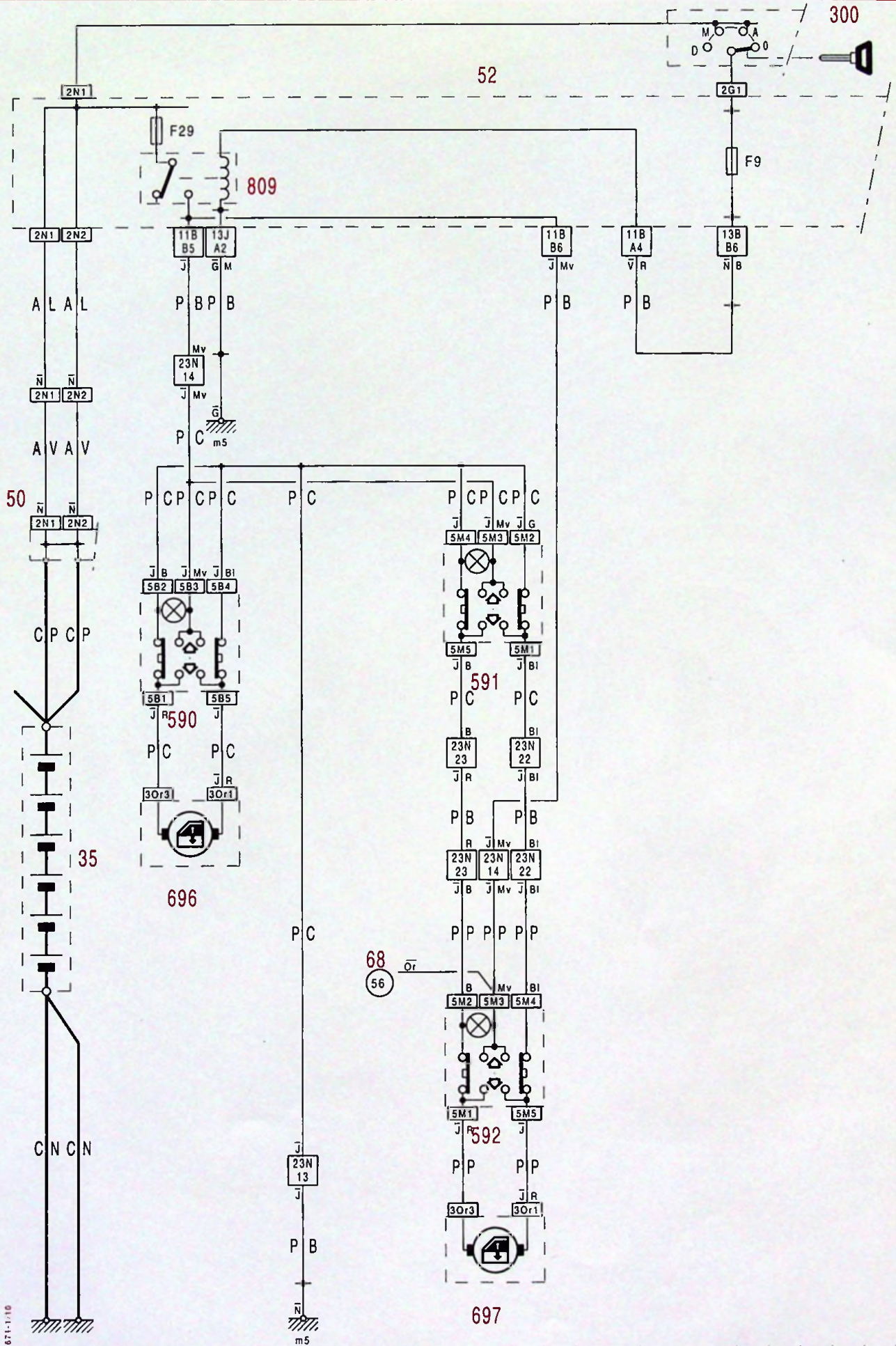

671-1/10

671-1/10

1 2 3 4 5 6 7 8 9 10 11 12 13 14 15 16 17 18 19 20 21 22 23 24 25 26 27 28 29



67



XM
671-1/20

3

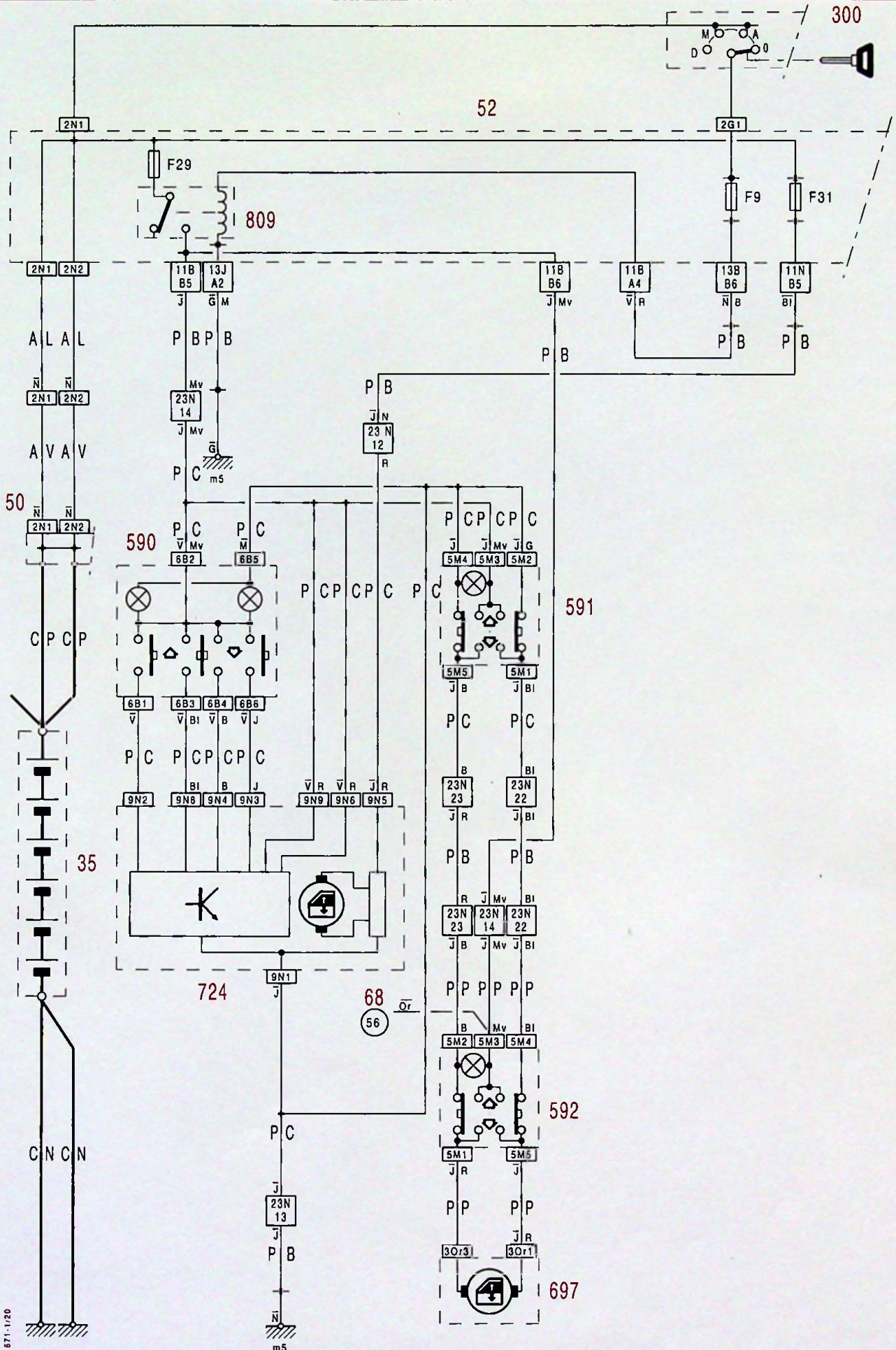

671-1/20

671-1/20

1 2 3 4 5 6 7 8 9 10 11 12 13 14 15 16 17 18 19 20 21 22 23 24 25 26 27 28 29



67



XM
671-1/20a

3

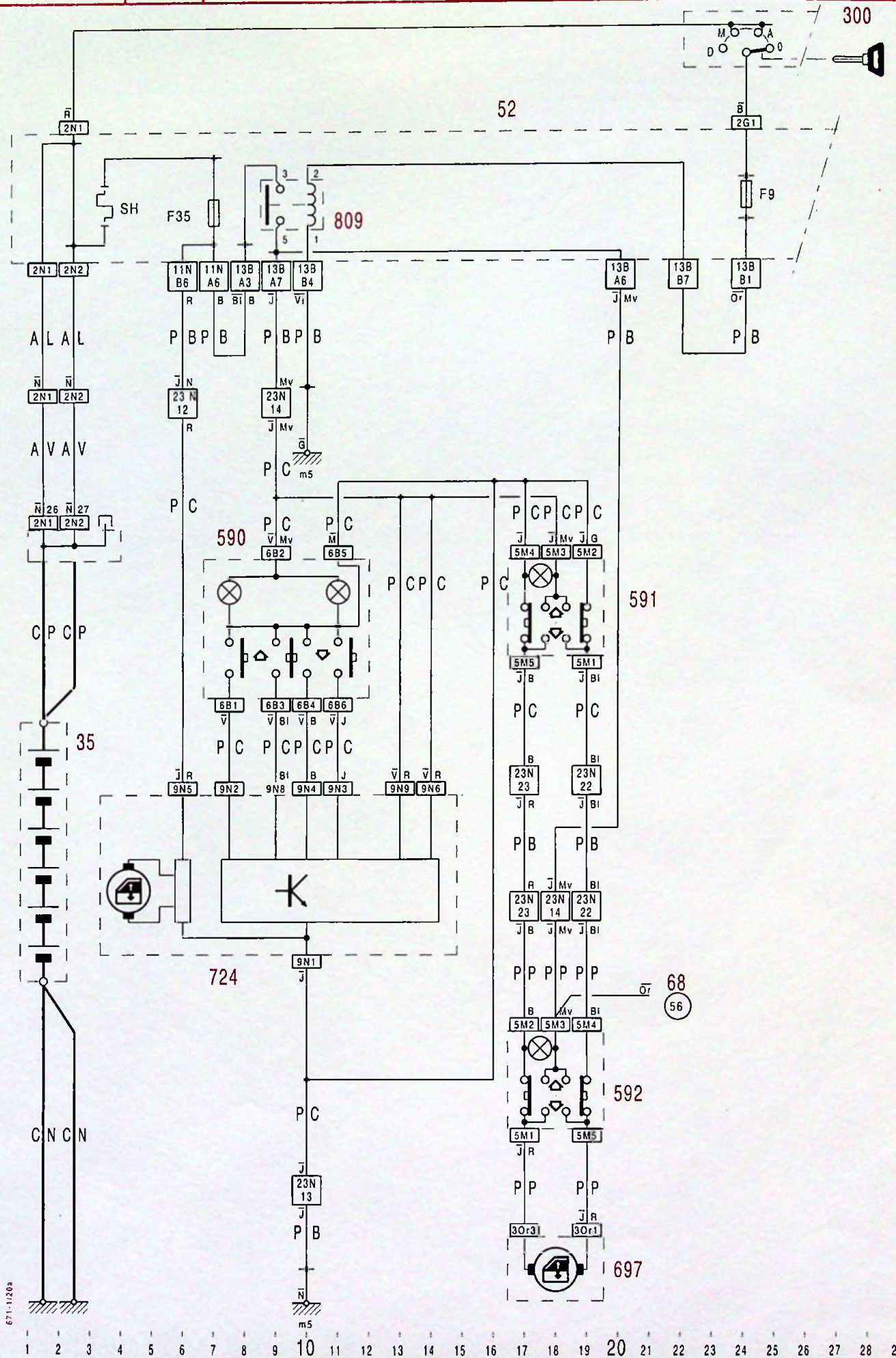

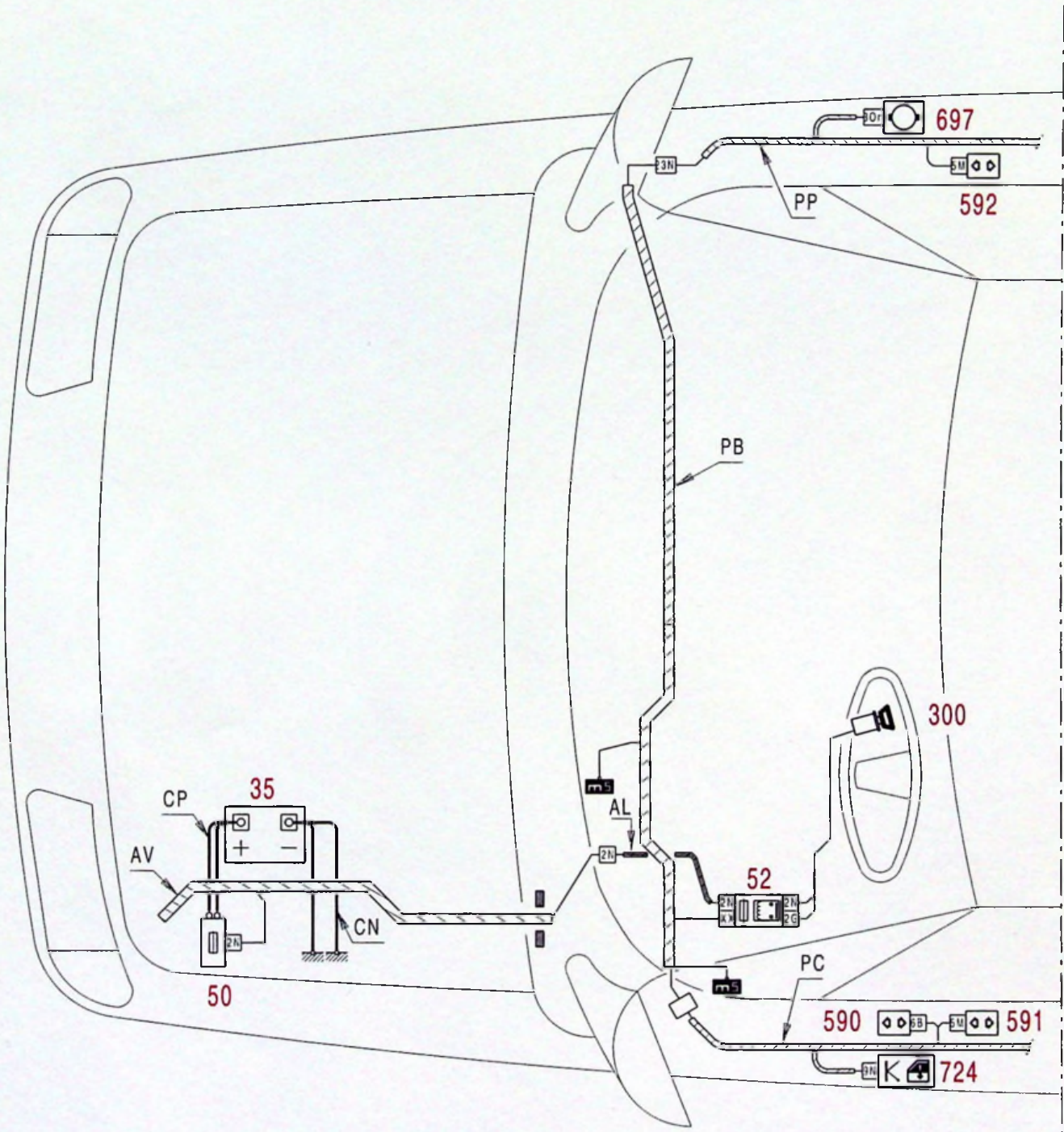



67



XM
671-1/20b

3

300

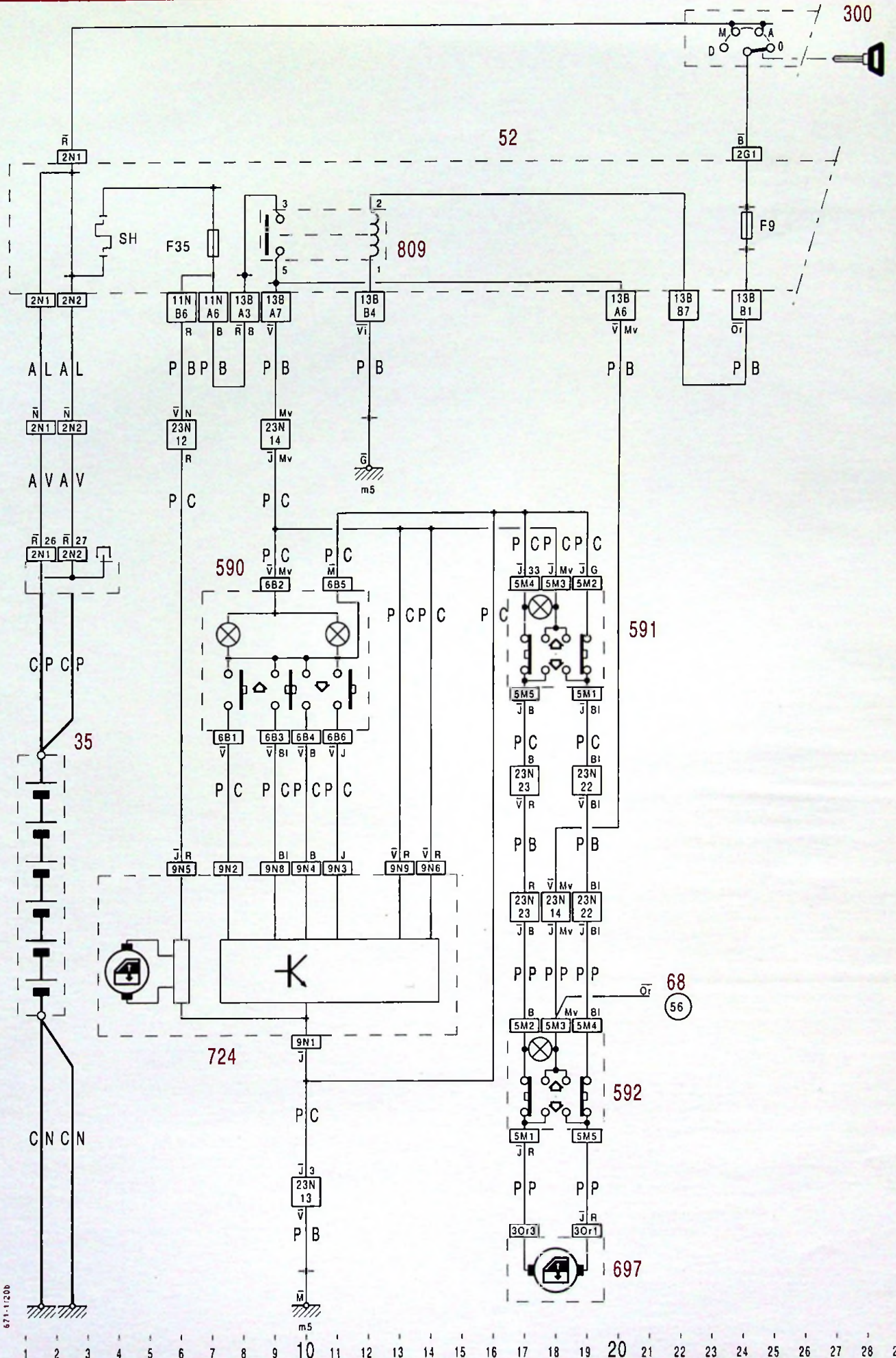

671-1/20b

671-1/20b

1 2 3 4 5 6 7 8 9 10 11 12 13 14 15 16 17 18 19 20 21 22 23 24 25 26 27 28 29



67



XM
671-1/50

3

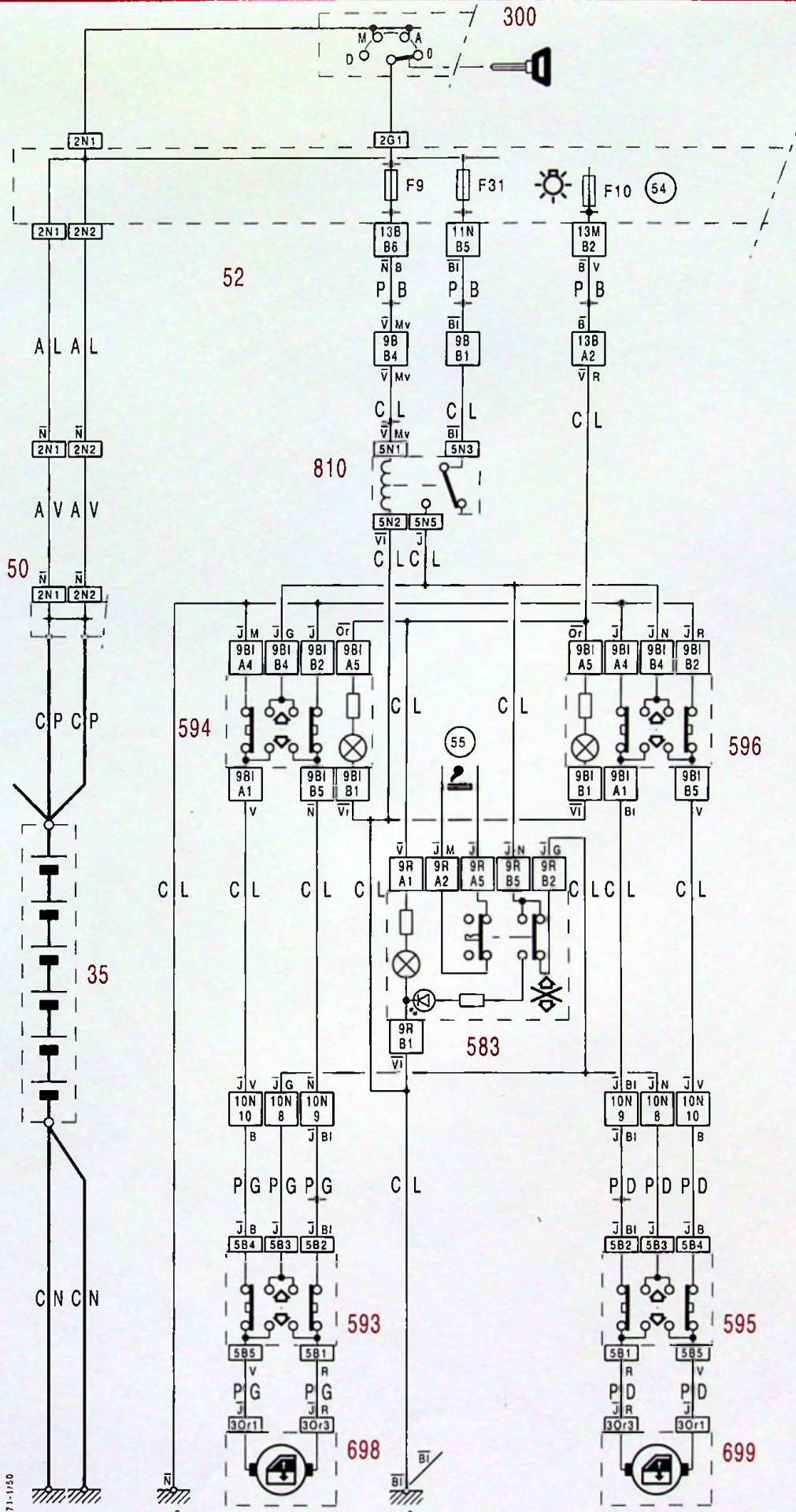

671-1/50

671-1/50



67



XM
671-1/50a

3

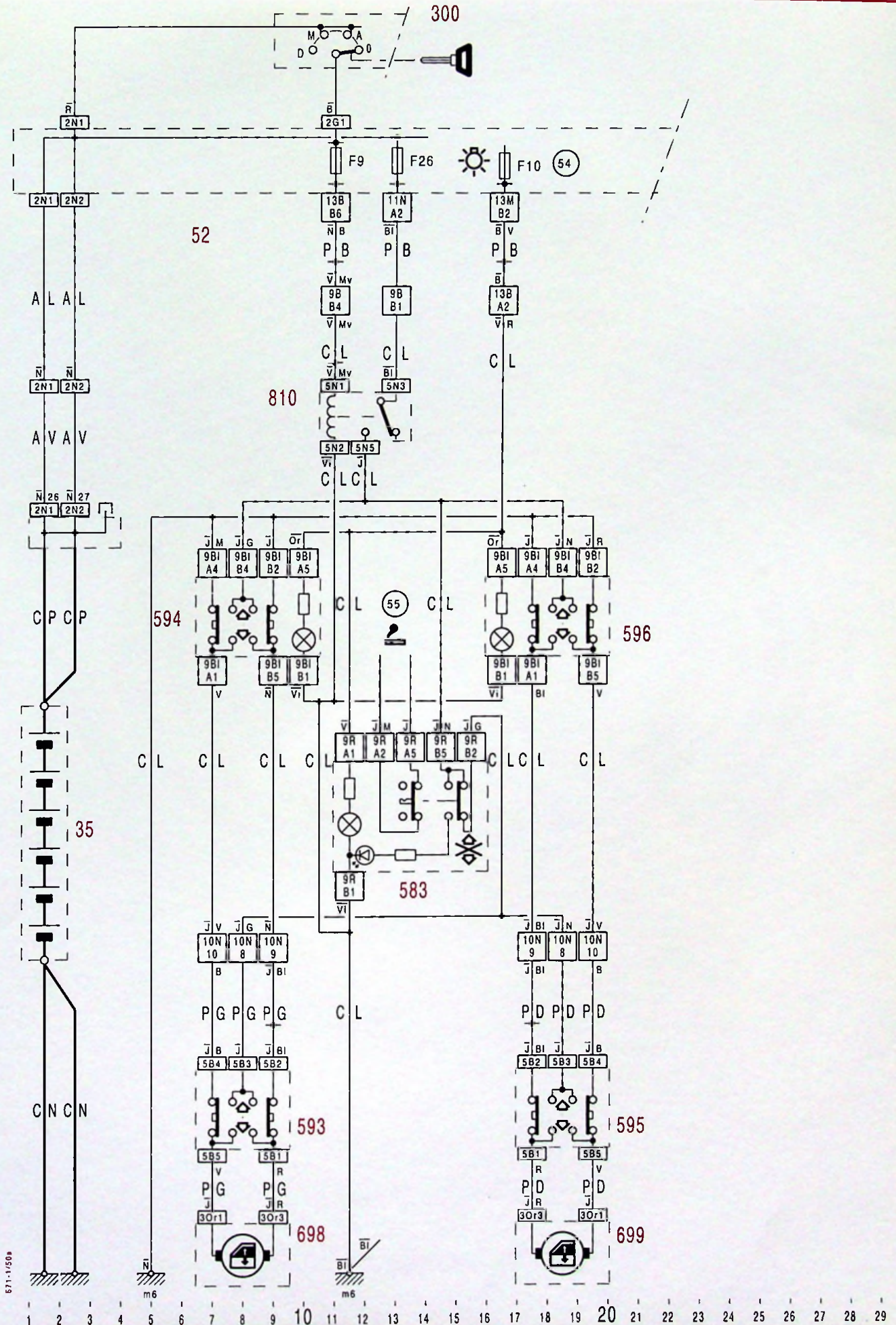

671-1/50a

671-1/50a



67



XM
671-1/50c

3

4

XM
671-1/50c

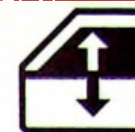

67

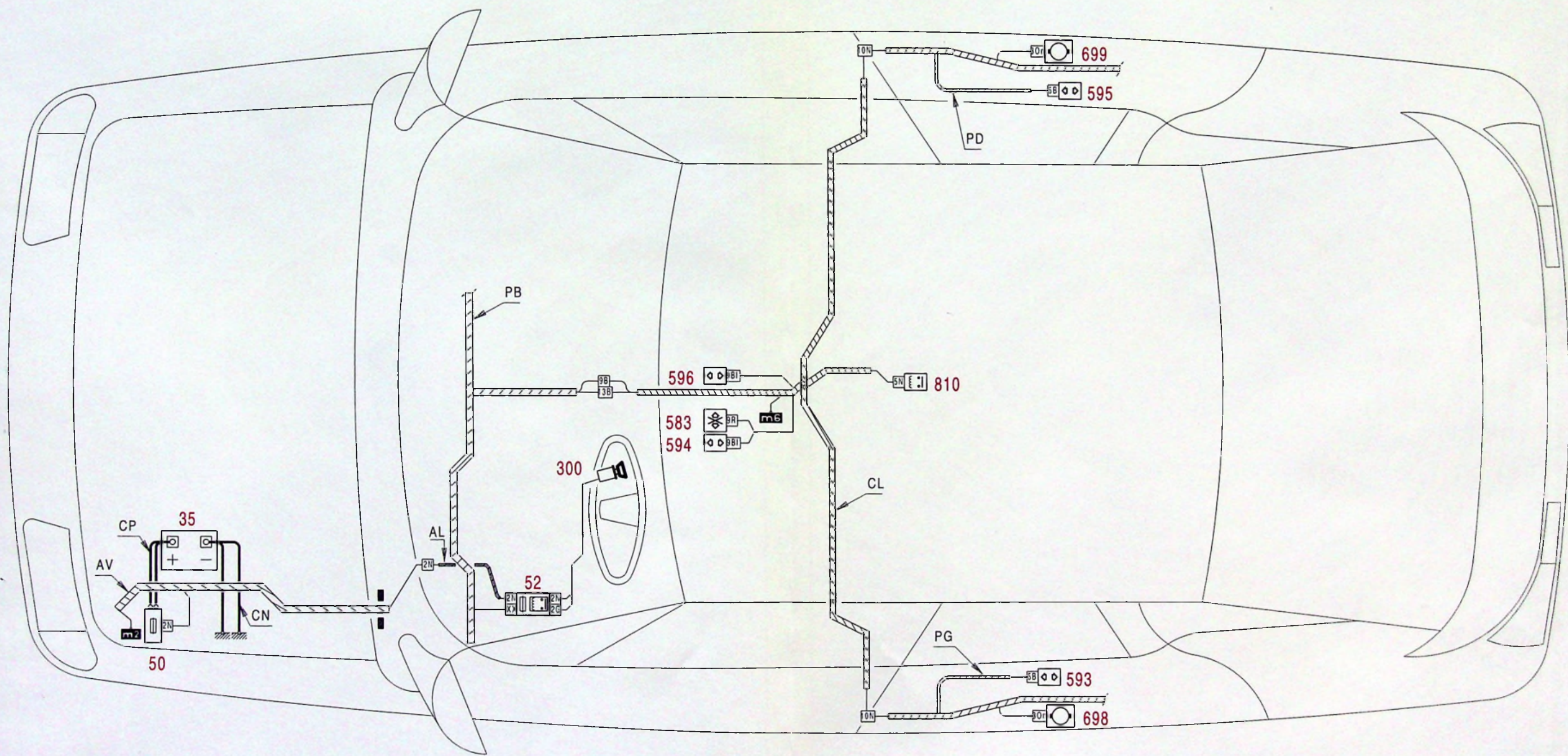

671-1/50d

671-1/50d

1 2 3 4 5 6 7 8 9 10 11 12 13 14 15 16 17 18 19 20 21 22 23 24 25 26 27 28 29 30 31 32 33 34 35 36 37 38 39 40 41 42 43 44 45 46 47 48 49 50 51 52 53 54 55 56 57 58 59 60 61 62



67



XM
671-1/50c

5

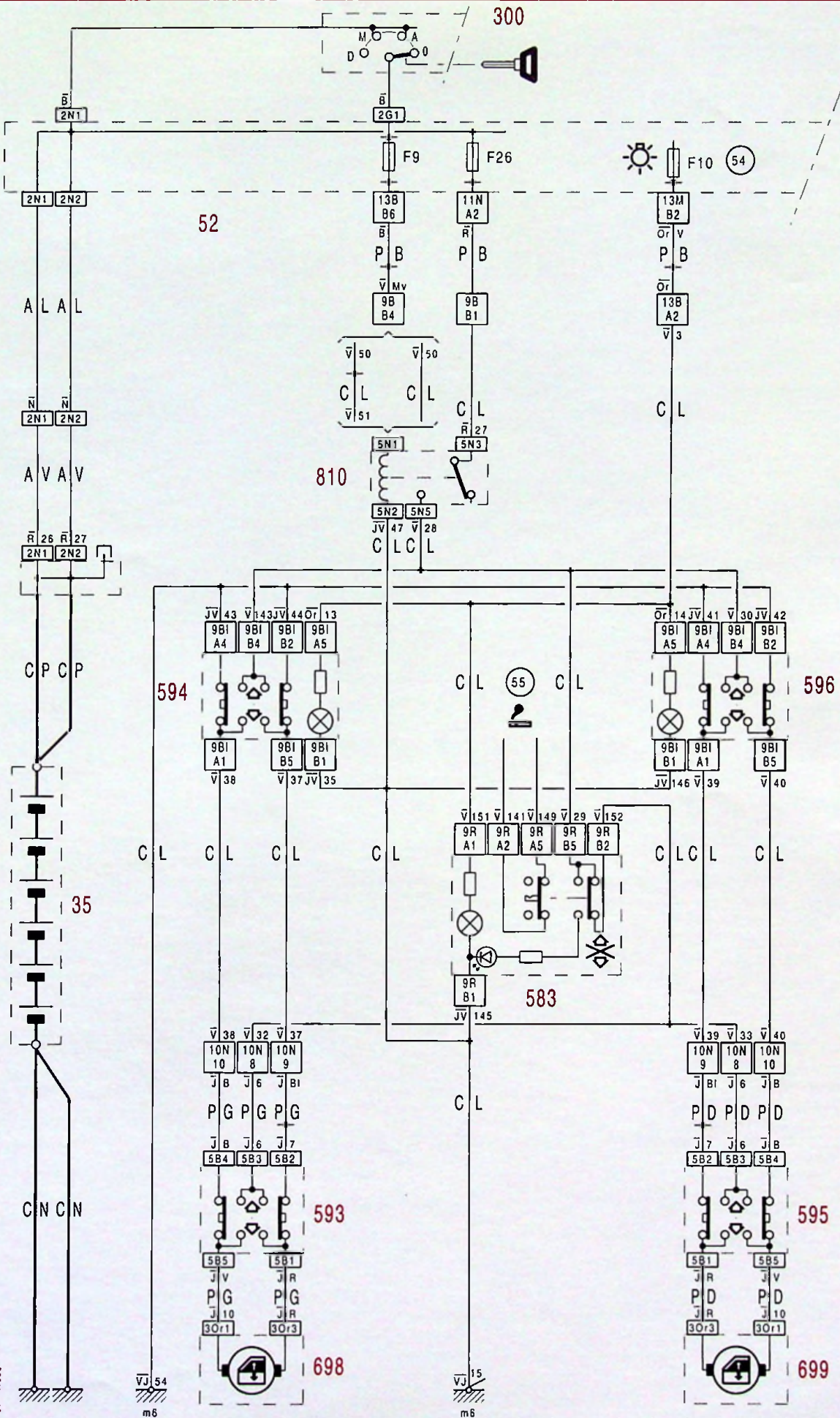

671-1/50c

671-1/50c

1 2 3 4 5 6 7 8 9 10 11 12 13 14 15 16 17 18 19 20 21 22 23 24 25 26 27 28 29



67



XM
671-1/50d

3

4

XM
671-1/50d



67

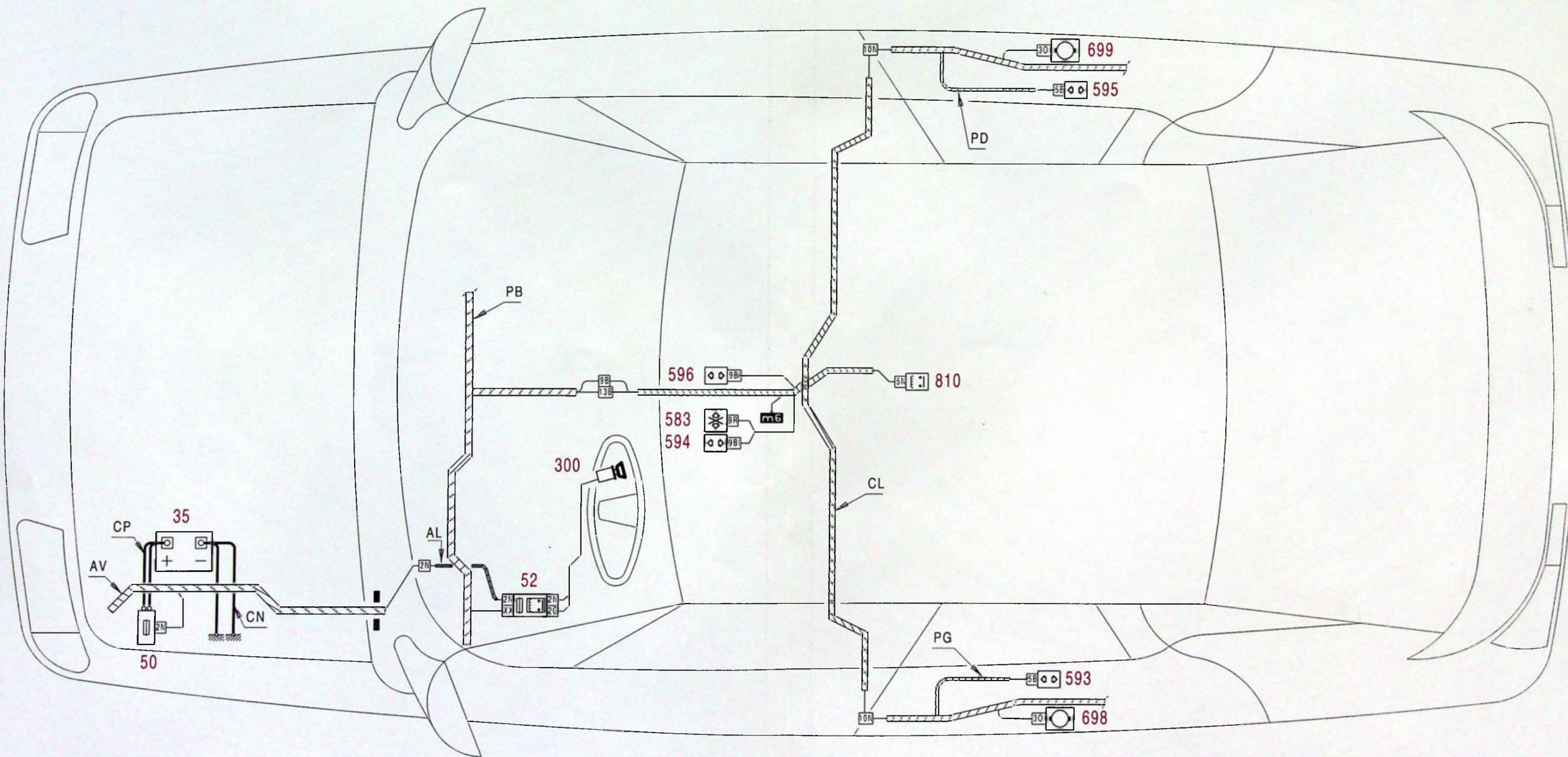



67



XM
671-1/50d

5

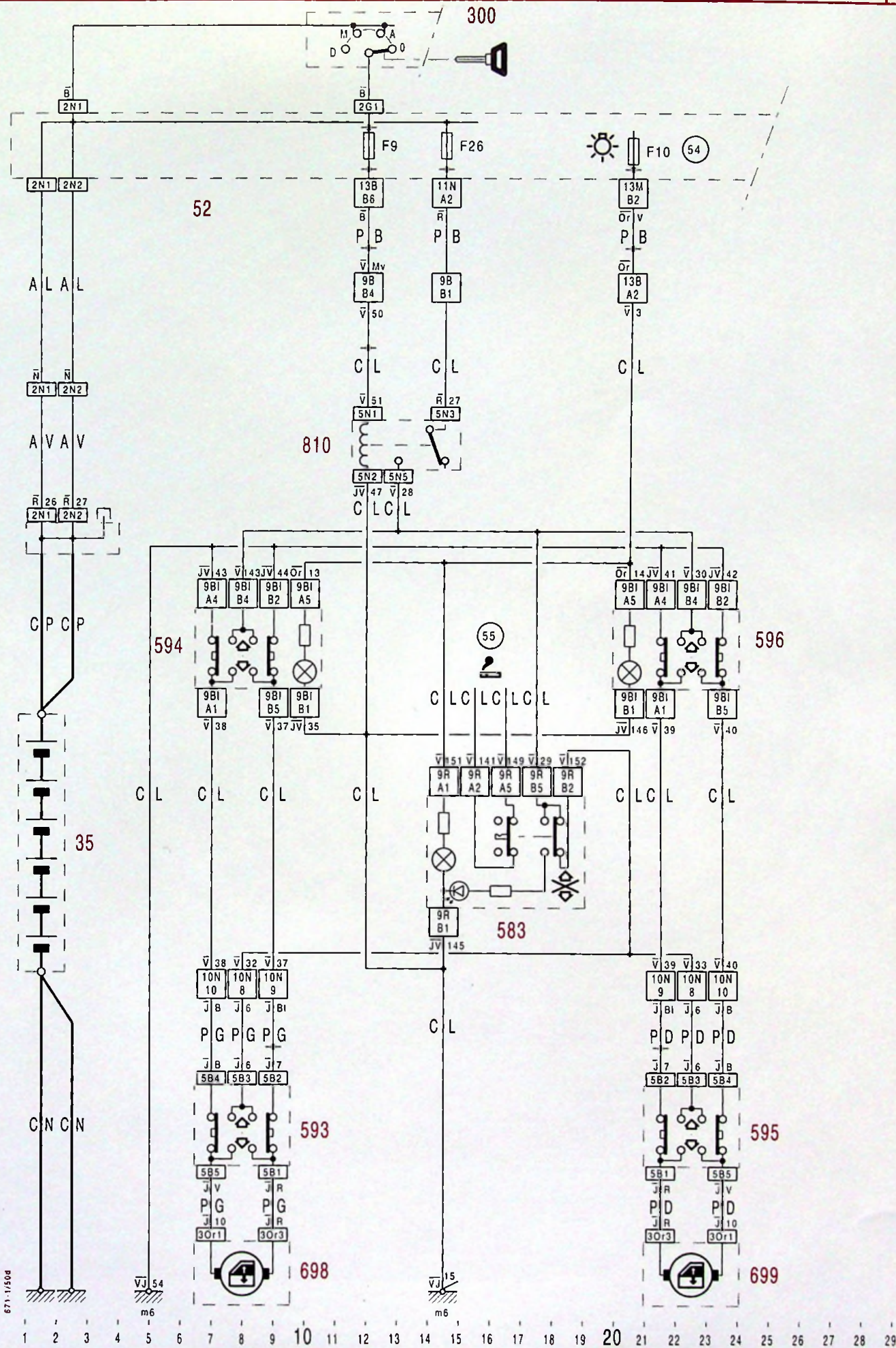



67



XM
671-1/55

3

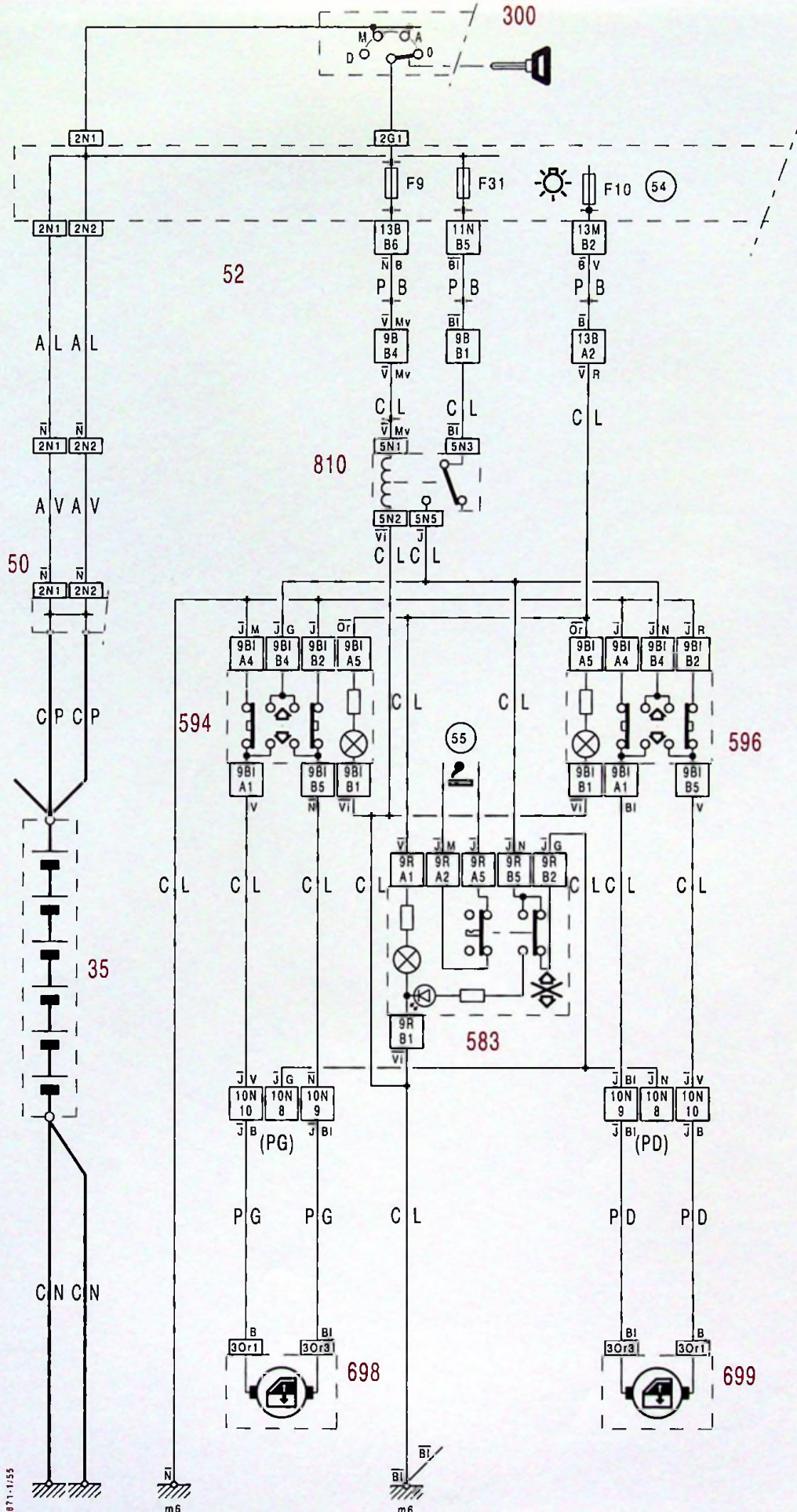

671-1/55

671-1/55

1 2 3 4 5 6 7 8 9 10 11 12 13 14 15 16 17 18 19 20 21 22 23 24 25 26 27 28 29



67



XM
671-1/55a

3

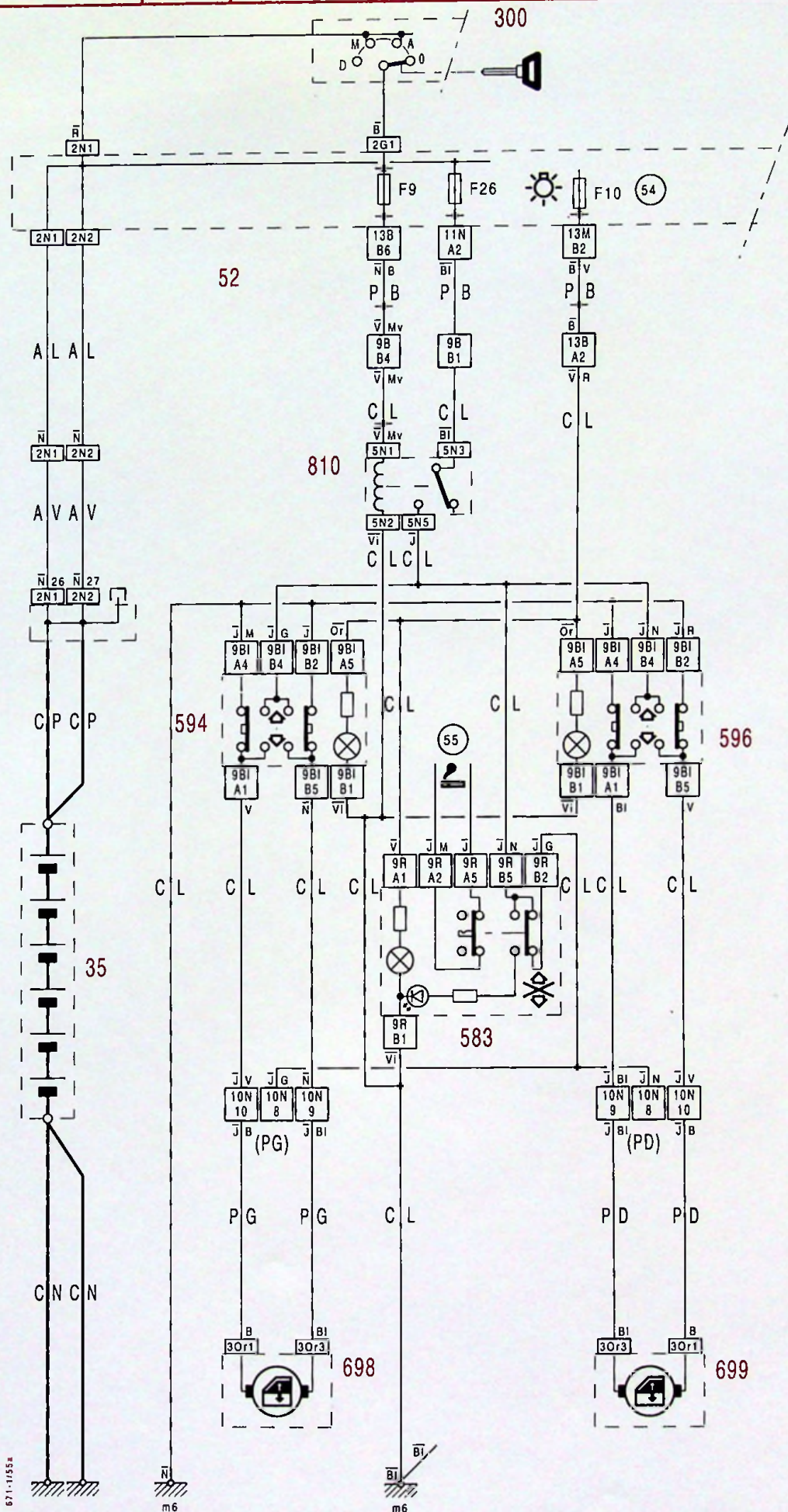

671-1/55a

671-1/55a



67



XM
671-1/55c

3

4

XM
671-1/55c



67

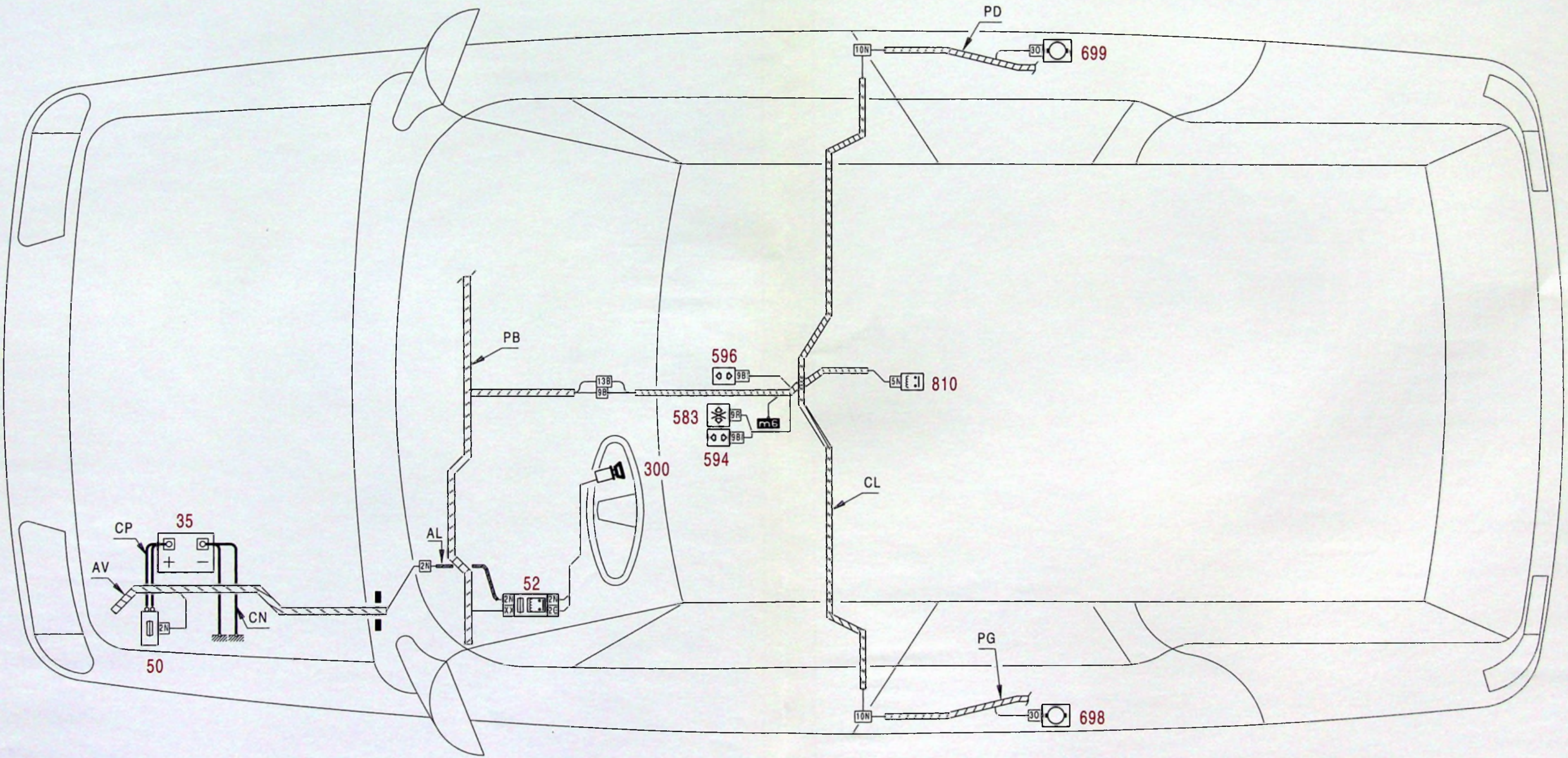



67



XM
671-1/55c

5

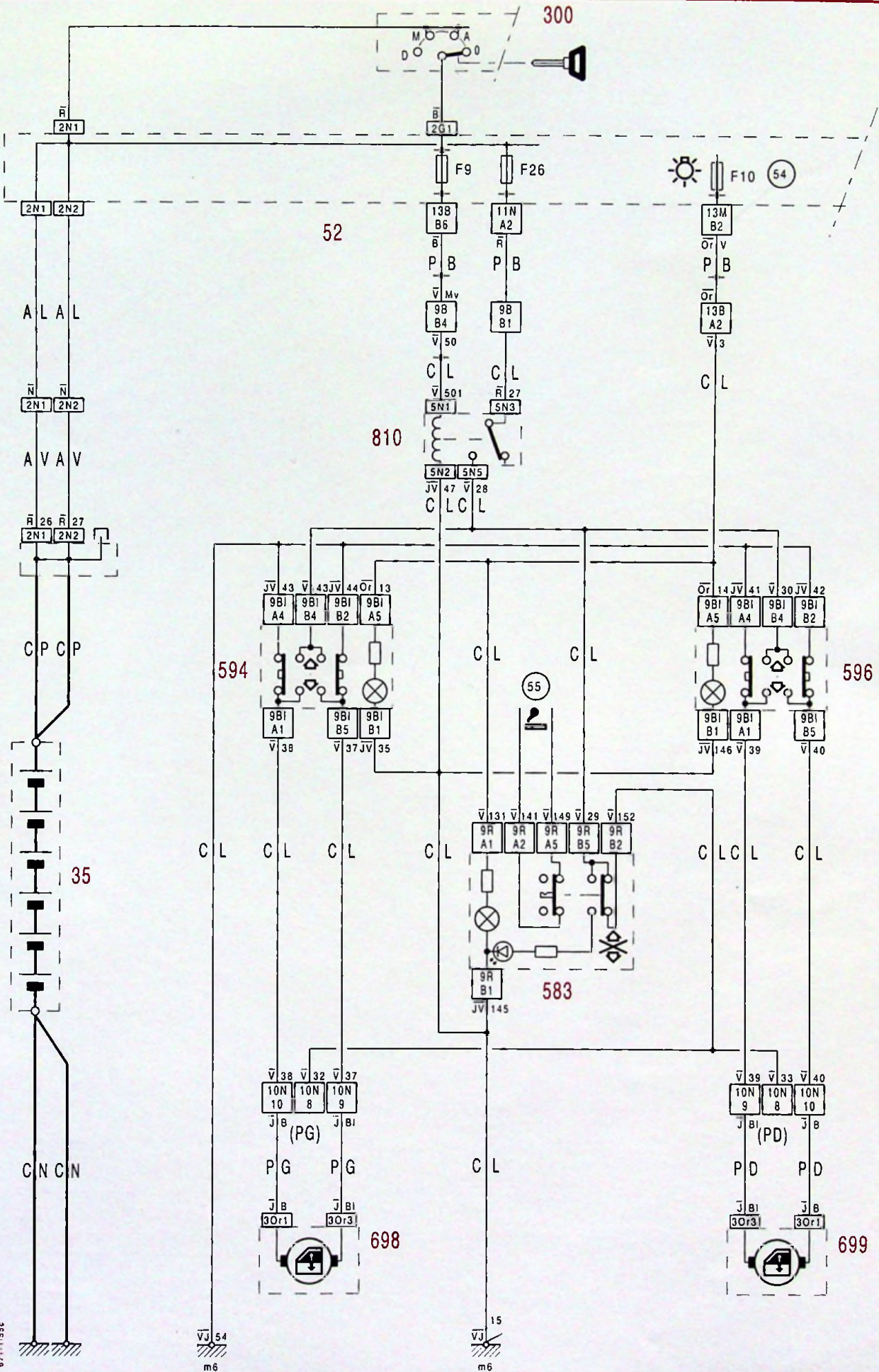

671-1/55c

VJ 54
m6

VJ 15
m6

671-1/55c

1 2 3 4 5 6 7 8 9 10 11 12 13 14 15 16 17 18 19 20 21 22 23 24 25 26 27 28 29



67



XM
671-2/50d

5

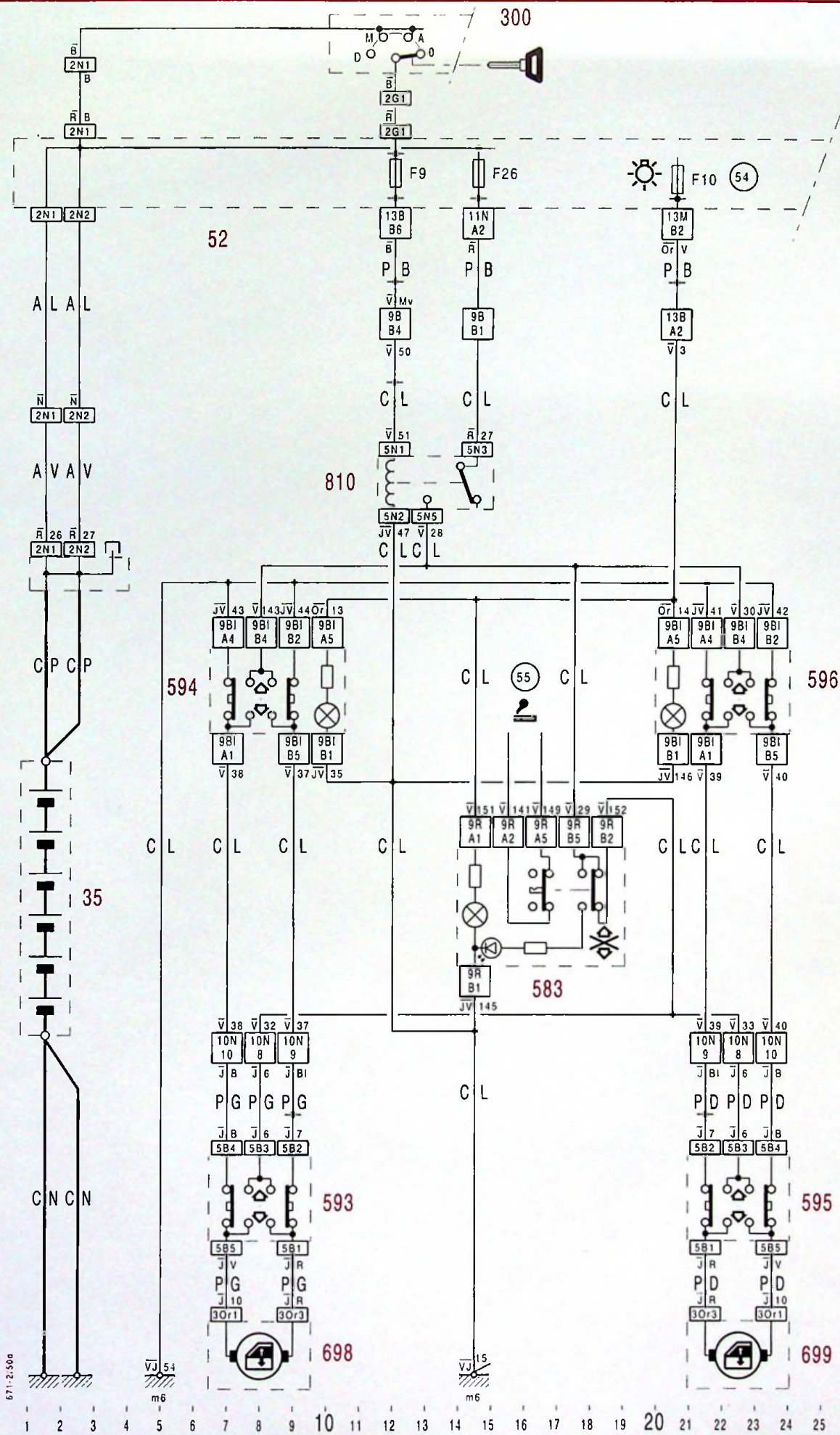

671-2/50d

VJ 54
m6

VJ 15
m6

671-2/50d



67



XM
671-2/10

3

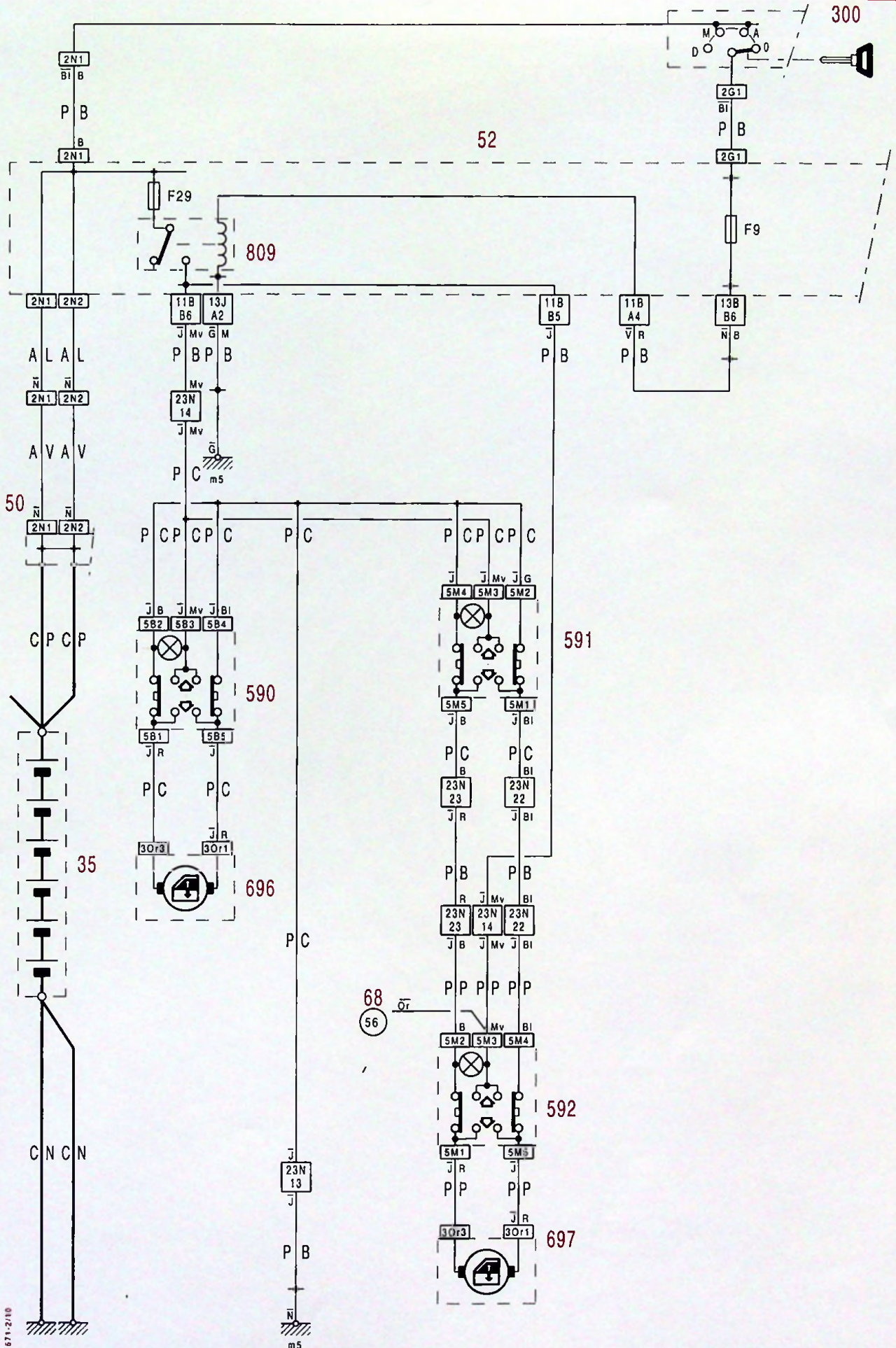

671-2/10

671-2/10

1 2 3 4 5 6 7 8 9 10 11 12 13 14 15 16 17 18 19 20 21 22 23 24 25 26 27 28 29



67



XM
671-2/10b

3

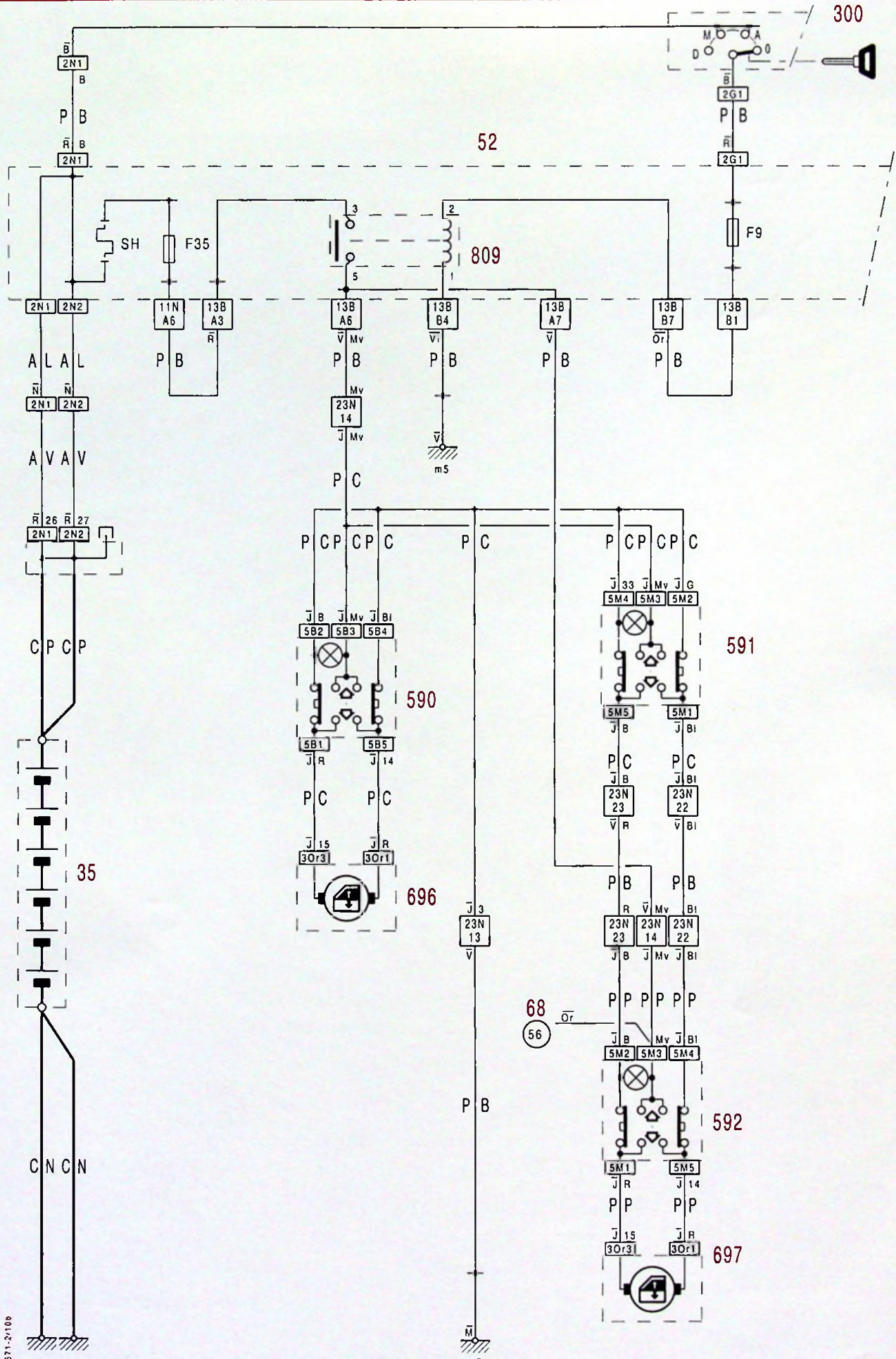

671-2/10b

671-2/10b



67

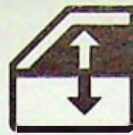

XM
671-2/20a

3

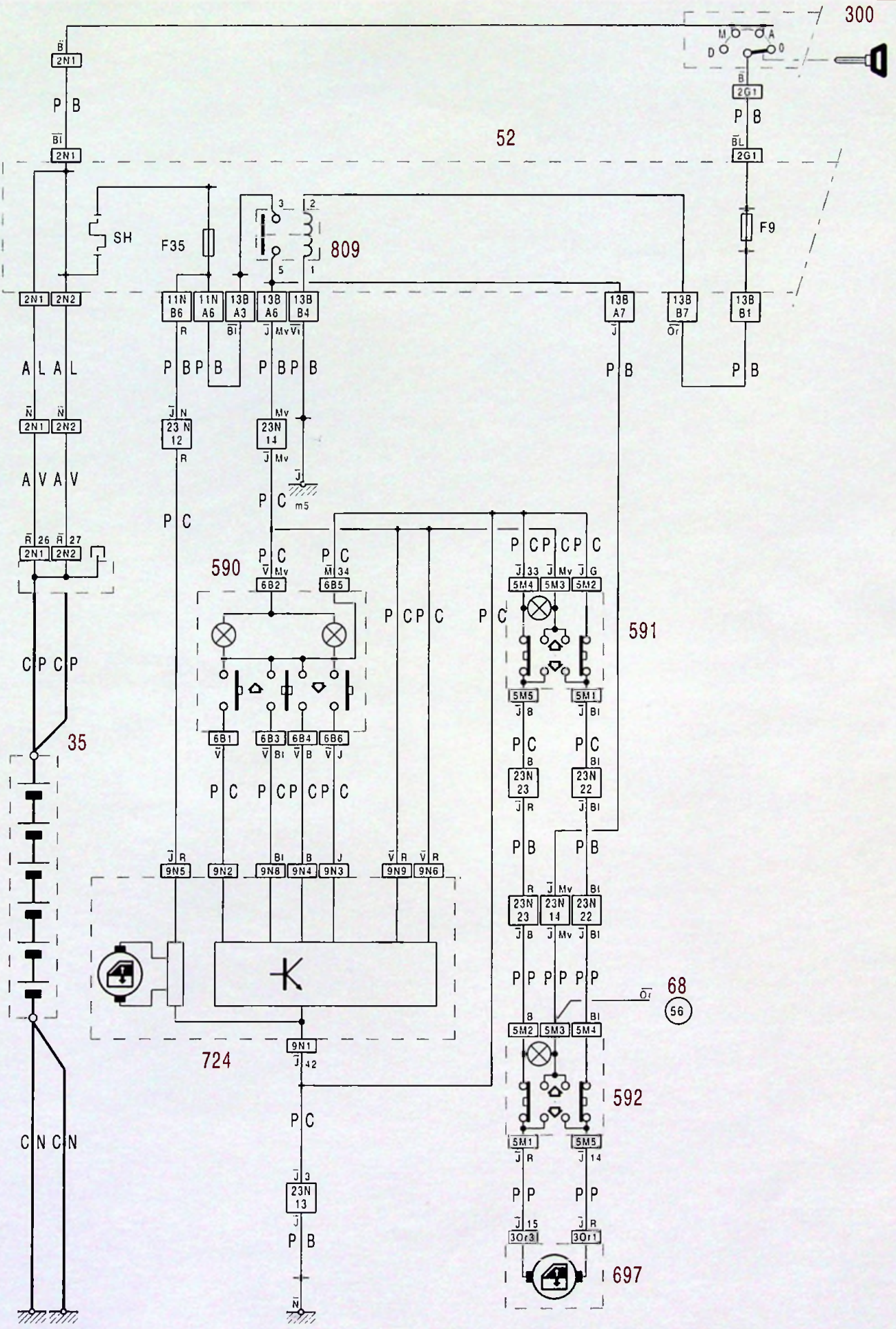

1 2 3 4 5 6 7 8 9 10 11 12 13 14 15 16 17 18 19 20 21 22 23 24 25 26 27 28 29



67



XM
671-2/50

3

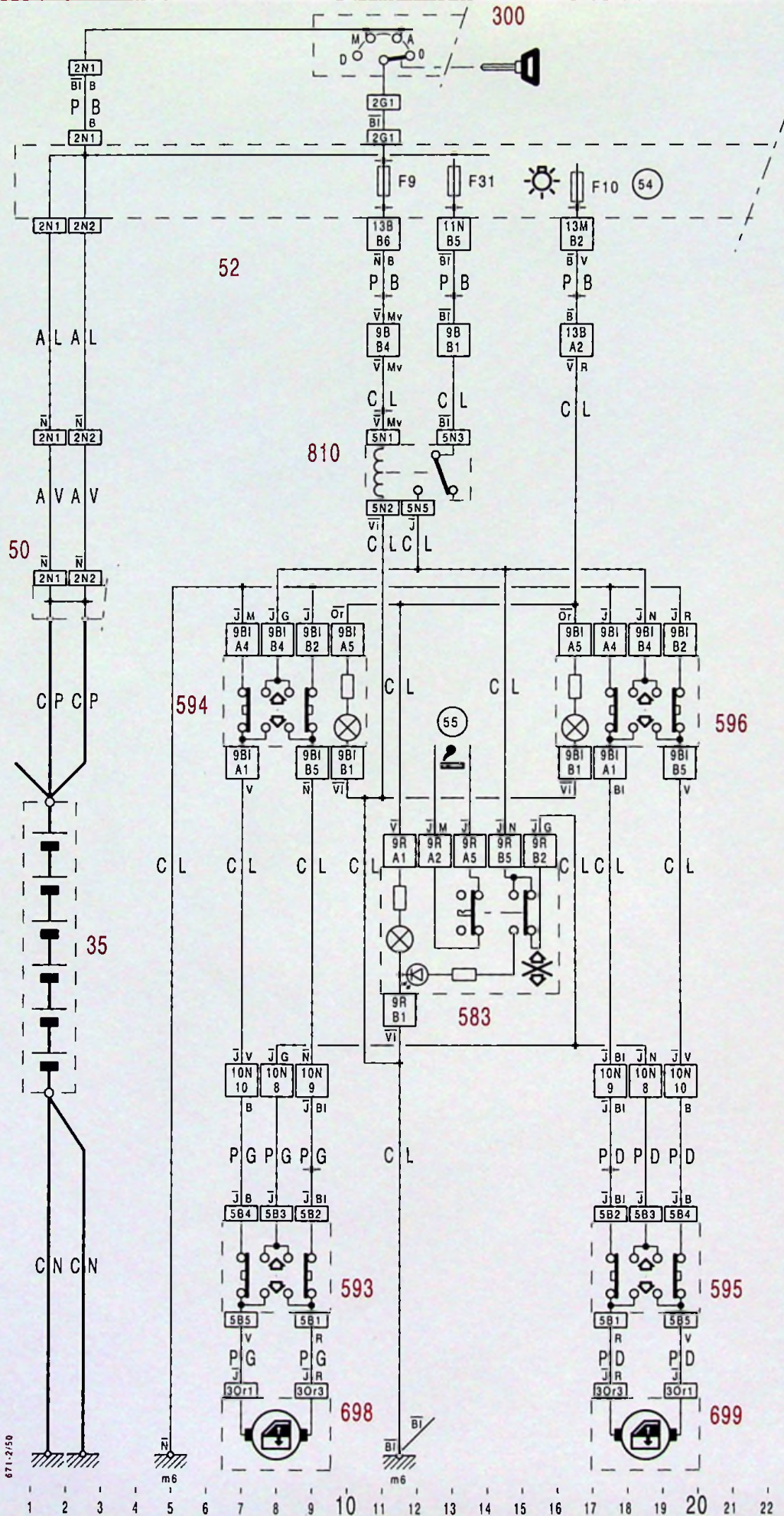

671-2/50

671-2/50

1 2 3 4 5 6 7 8 9 10 11 12 13 14 15 16 17 18 19 20 21 22 23 24 25 26 27 28 29



67



XM
671-2/50a

3

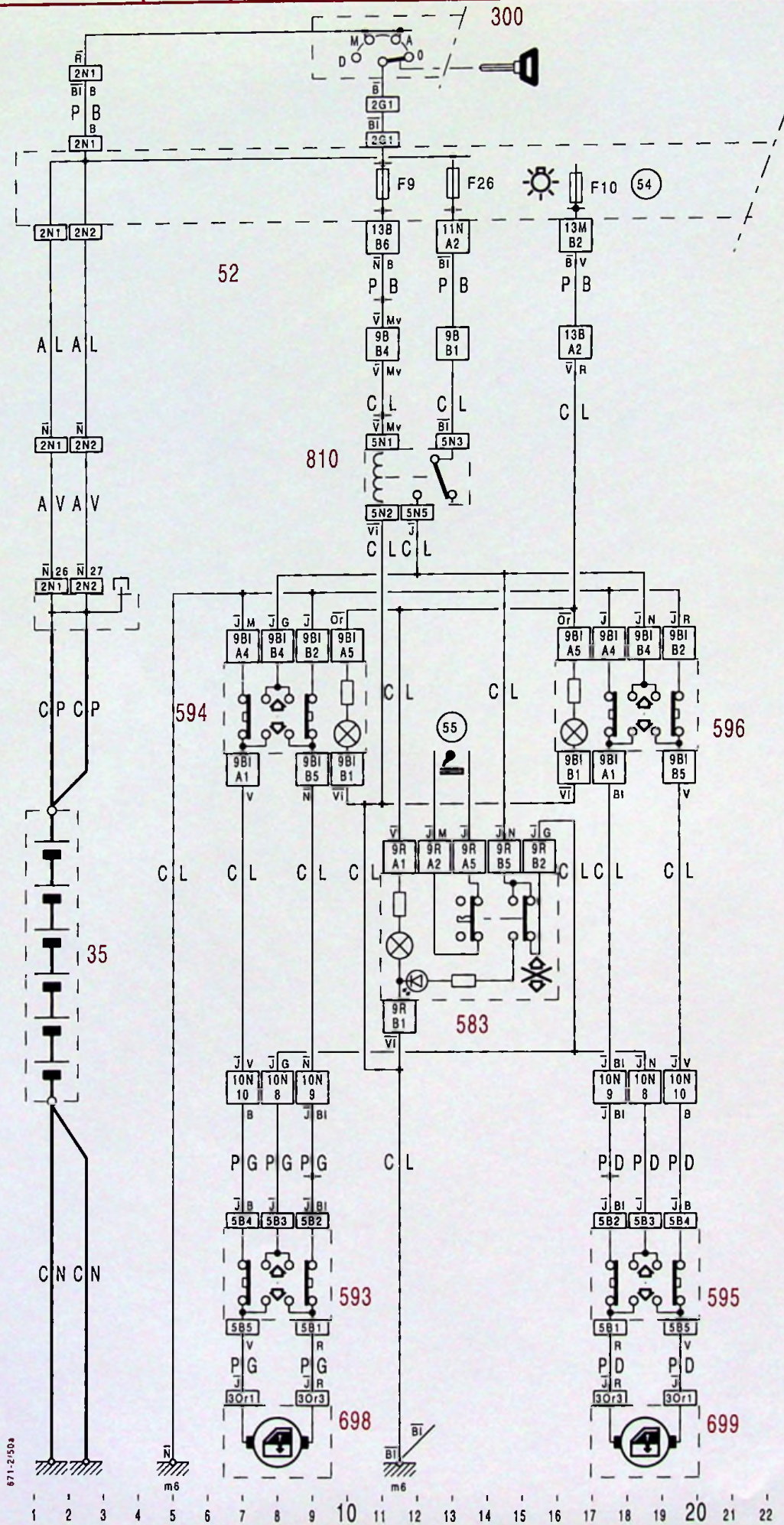

671-2/50a

671-2/50a



67



XM
671-2/50b

3

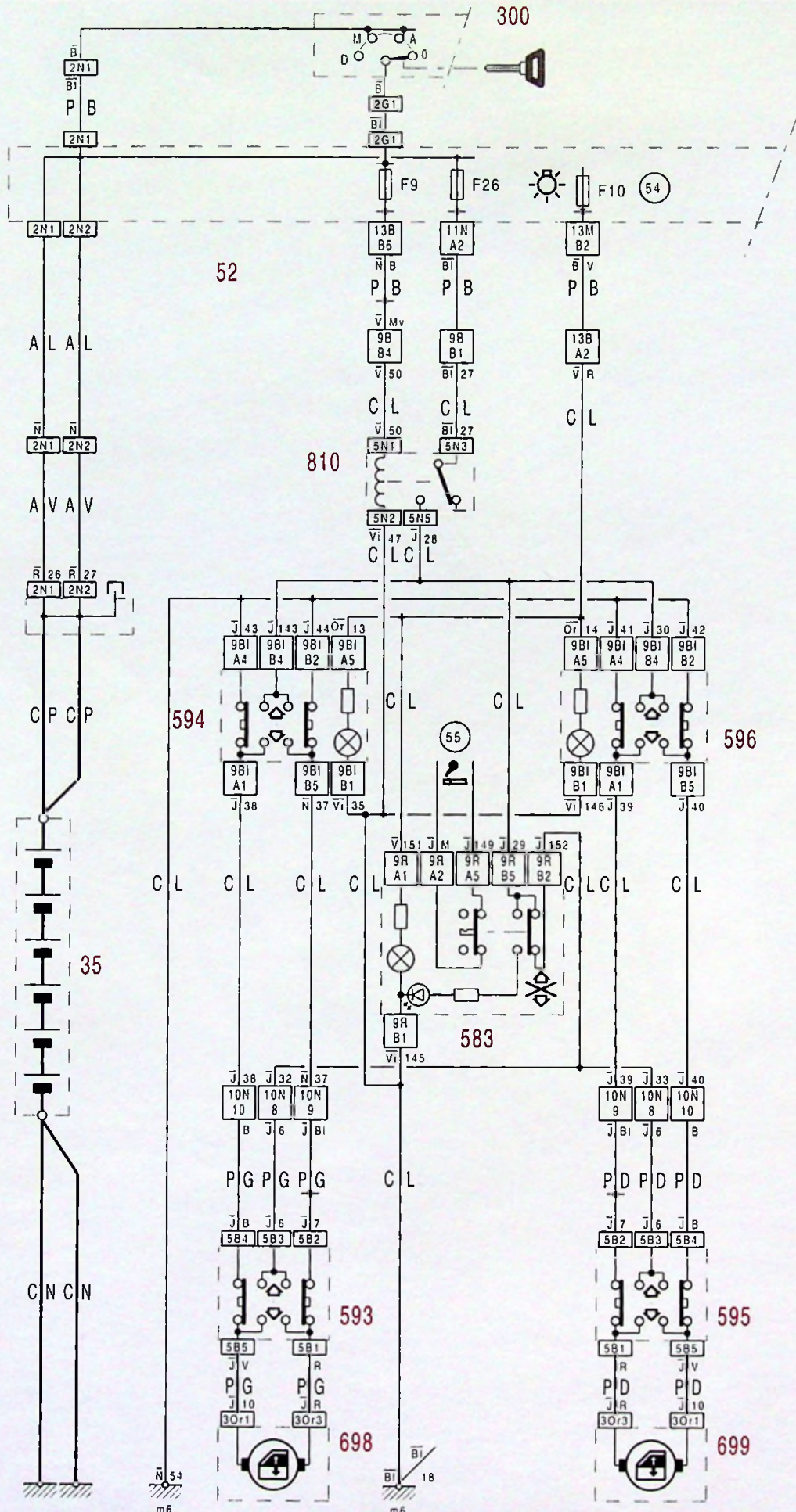

1 2 3 4 5 6 7 8 9 10 11 12 13 14 15 16 17 18 19 20 21 22 23 24 25 26 27 28 29



67



XM
671-2/50d

5

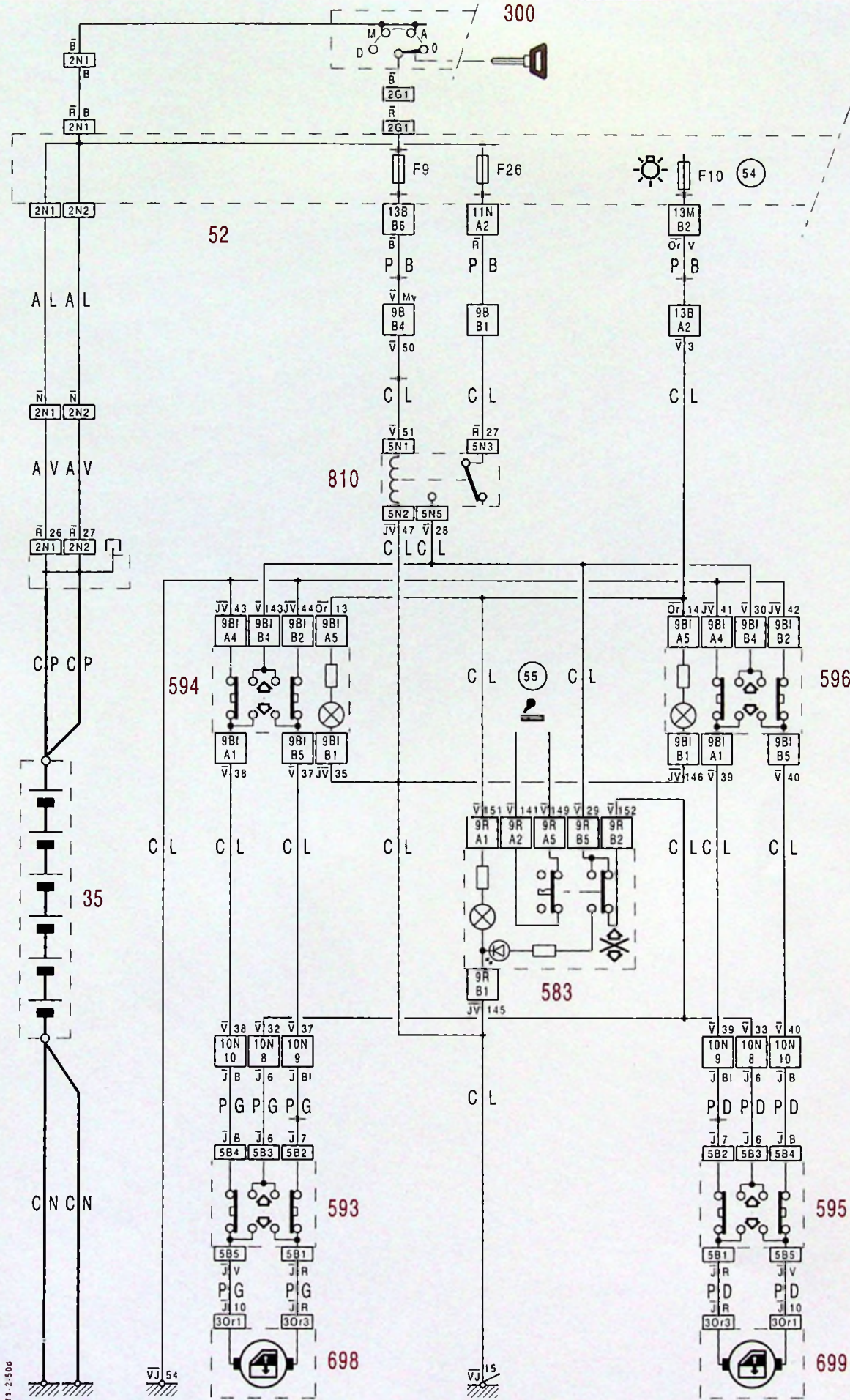

671-2/50d

VJ 54
m6

VJ 15
m6

671-2/50d

1 2 3 4 5 6 7 8 9 10 11 12 13 14 15 16 17 18 19 20 21 22 23 24 25 26 27 28 29



67



XM
672-1/20a

6

7

XM
672-1/20a



67

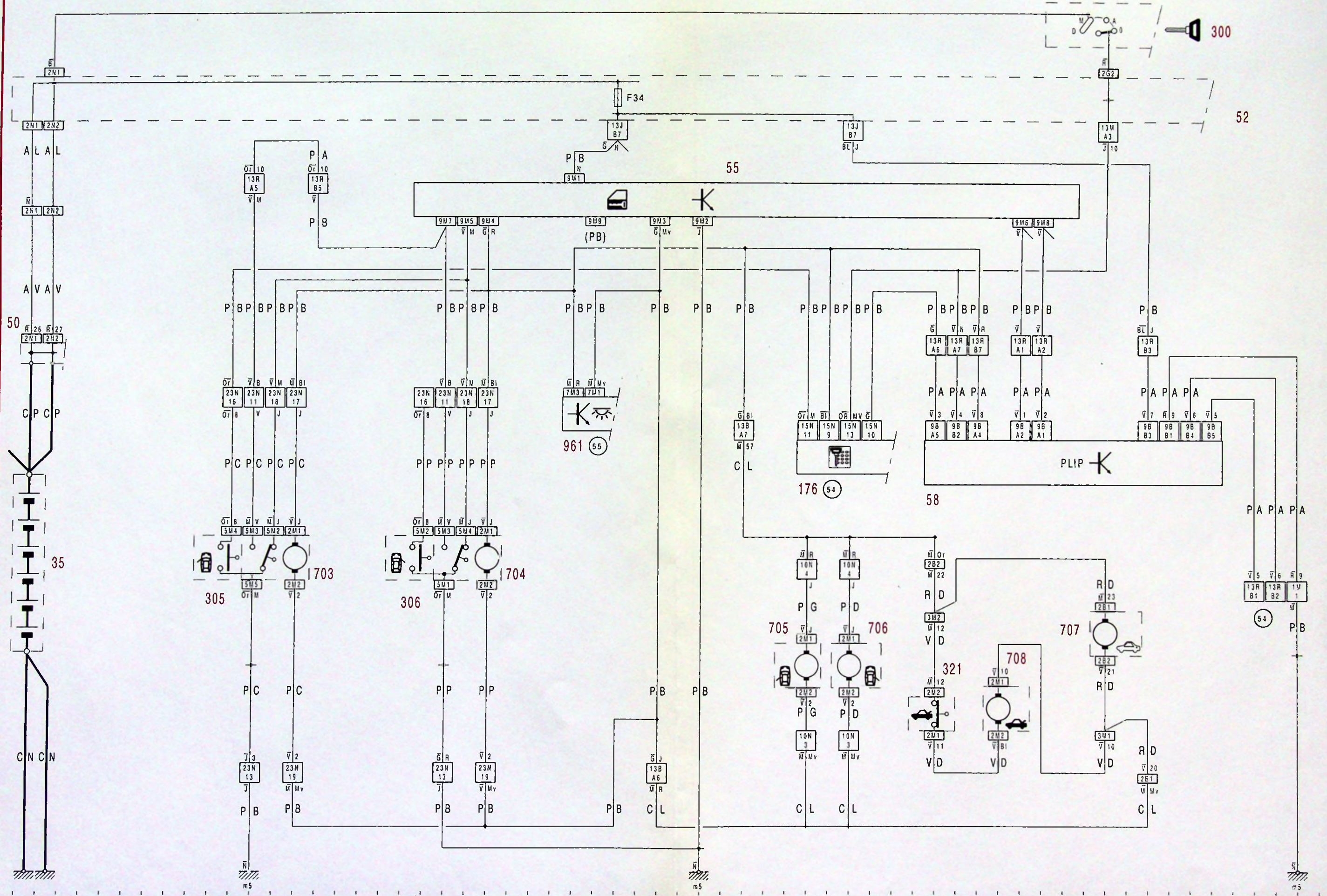

1 2 3 4 5 6 7 8 9 10 11 12 13 14 15 16 17 18 19 20 21 22 23 24 25 26 27 28 29 30 31 32 33 34 35 36 37 38 39 40 41 42 43 44 45 46 47 48 49 50 51 52 53 54 55 56 57 58 59 60 61 62



67



XMI
672-1/20b

3

4

RSA
672-1/20b



67

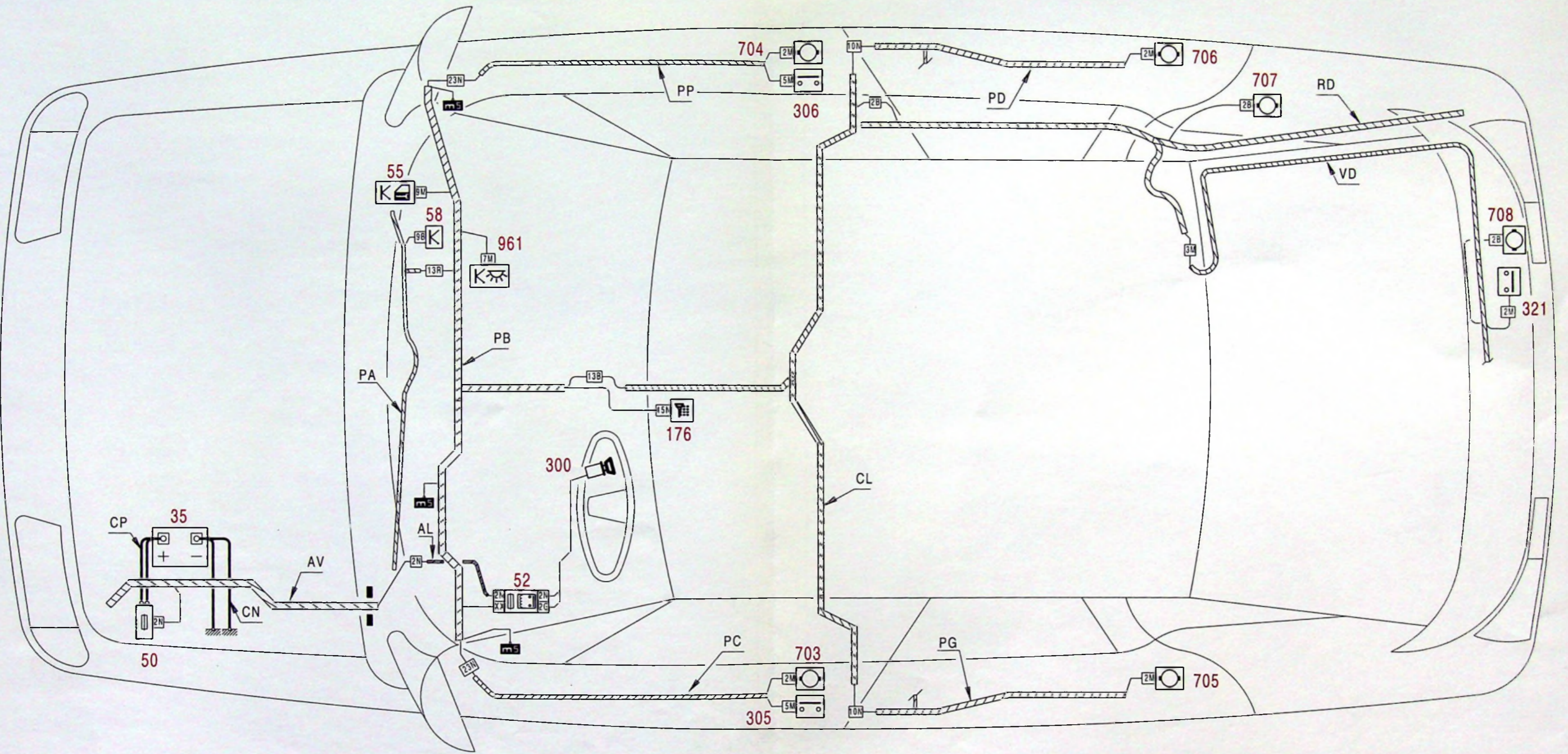

672-1/20b

1 2 3 4 5 6 7 8 9 10 11 12 13 14 15 16 17 18 19 20 21 22 23 24 25 26 27 28 29 30 31 32 33 34 35 36 37 38 39 40 41 42 43 44 45 46 47 48 49 50 51 52 53 54 55 56 57 58 59 60 61 62

672-1/20b



67



XM
672-1/30

5

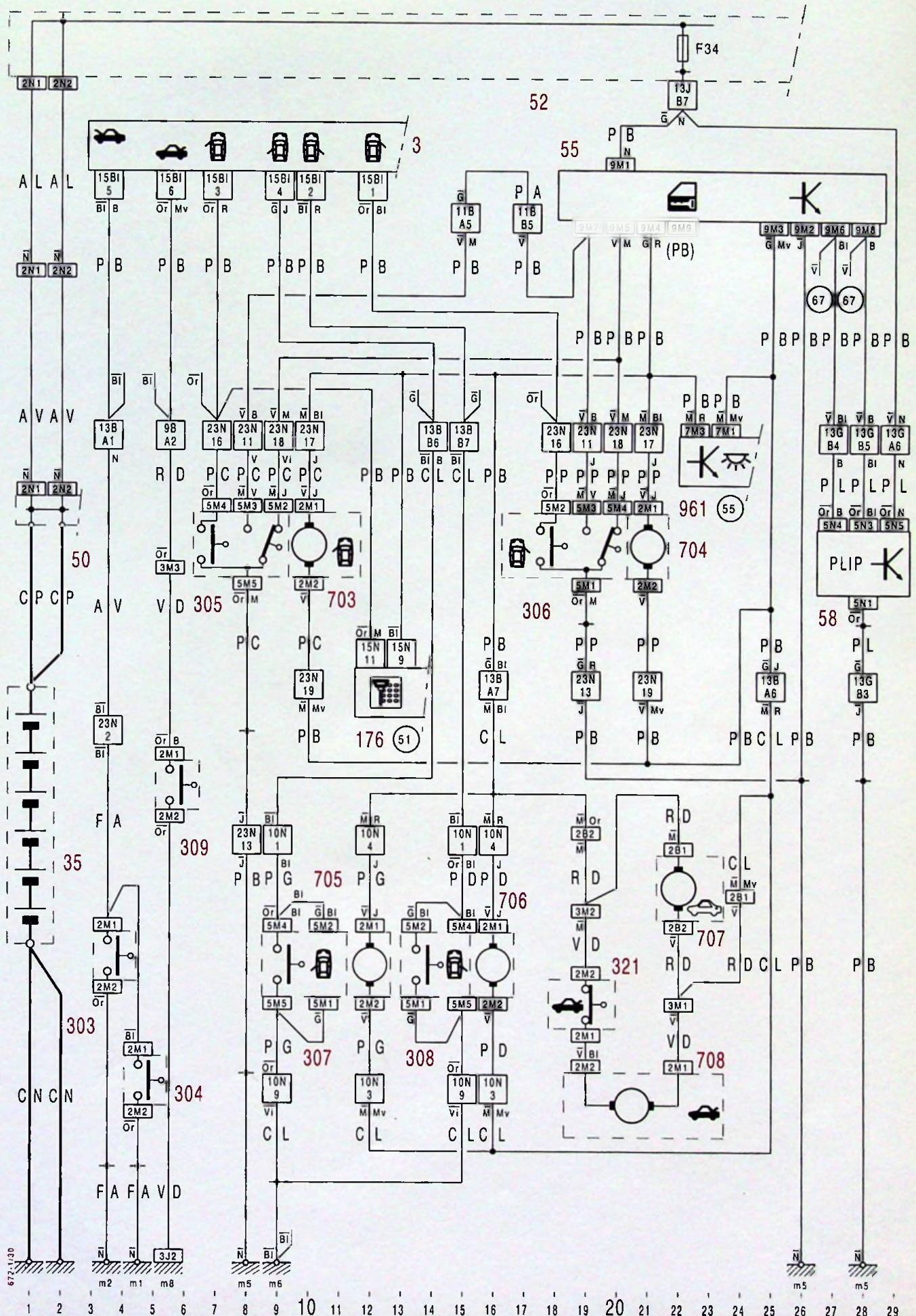

672-1/30

672-1/30



67



XM
672-1/30d

6

7

XM
672-1/30d



67

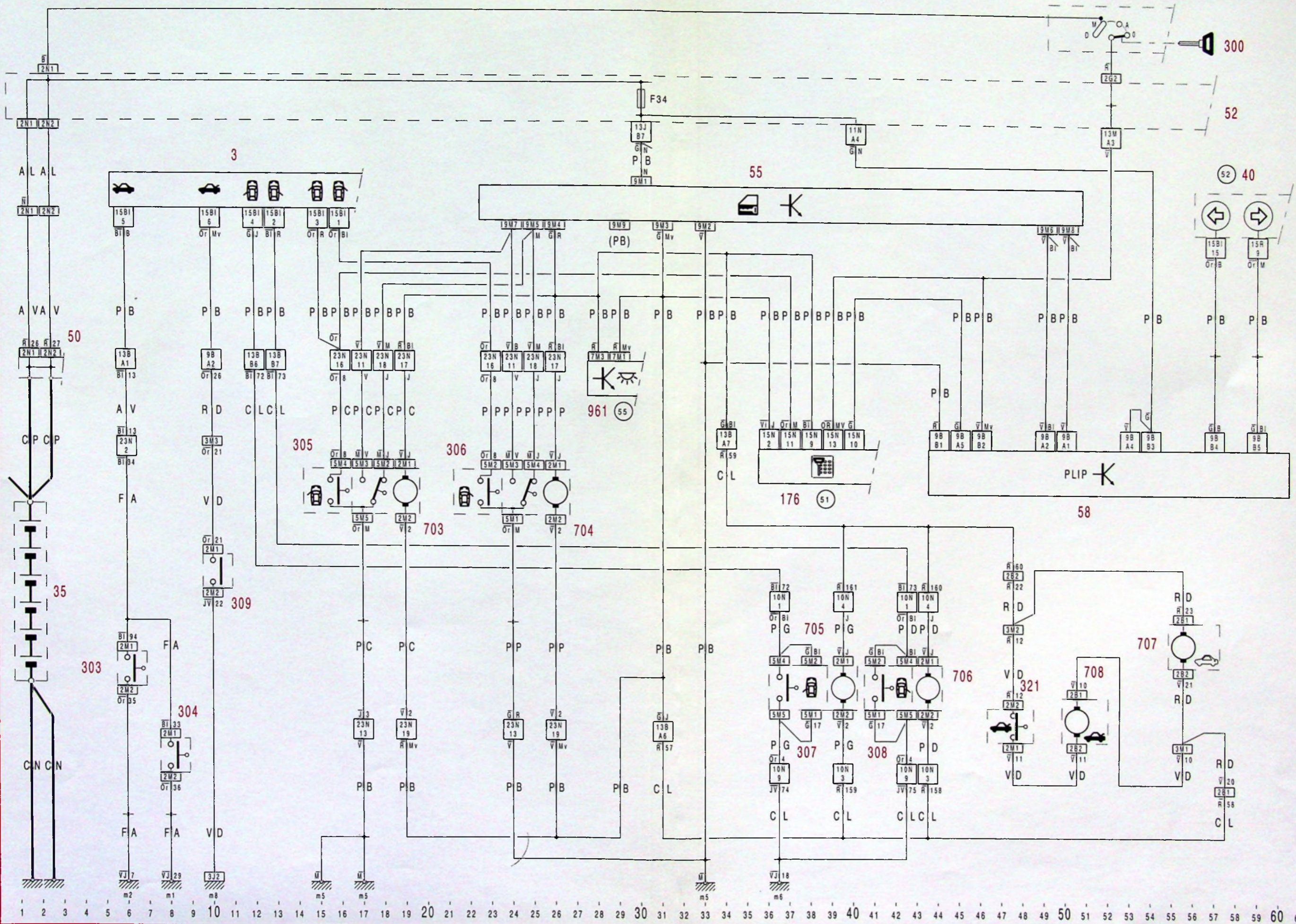



67



XM
672-1/40b

6

7

XM
672-1/40b



67

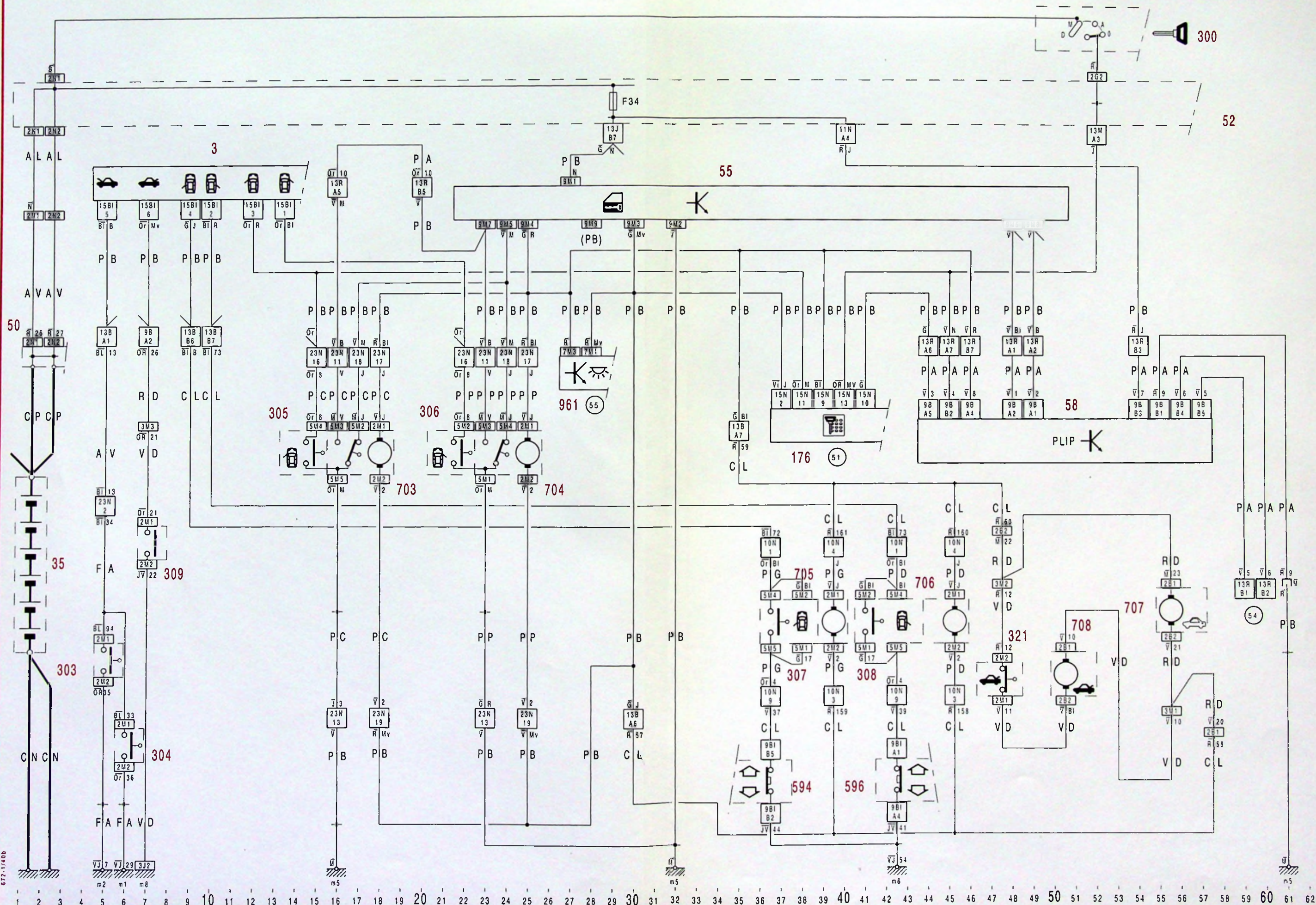

672-1/40b

672-1/40b



67



XM
672-1/40c

3

4

XM
672-1/40c



67

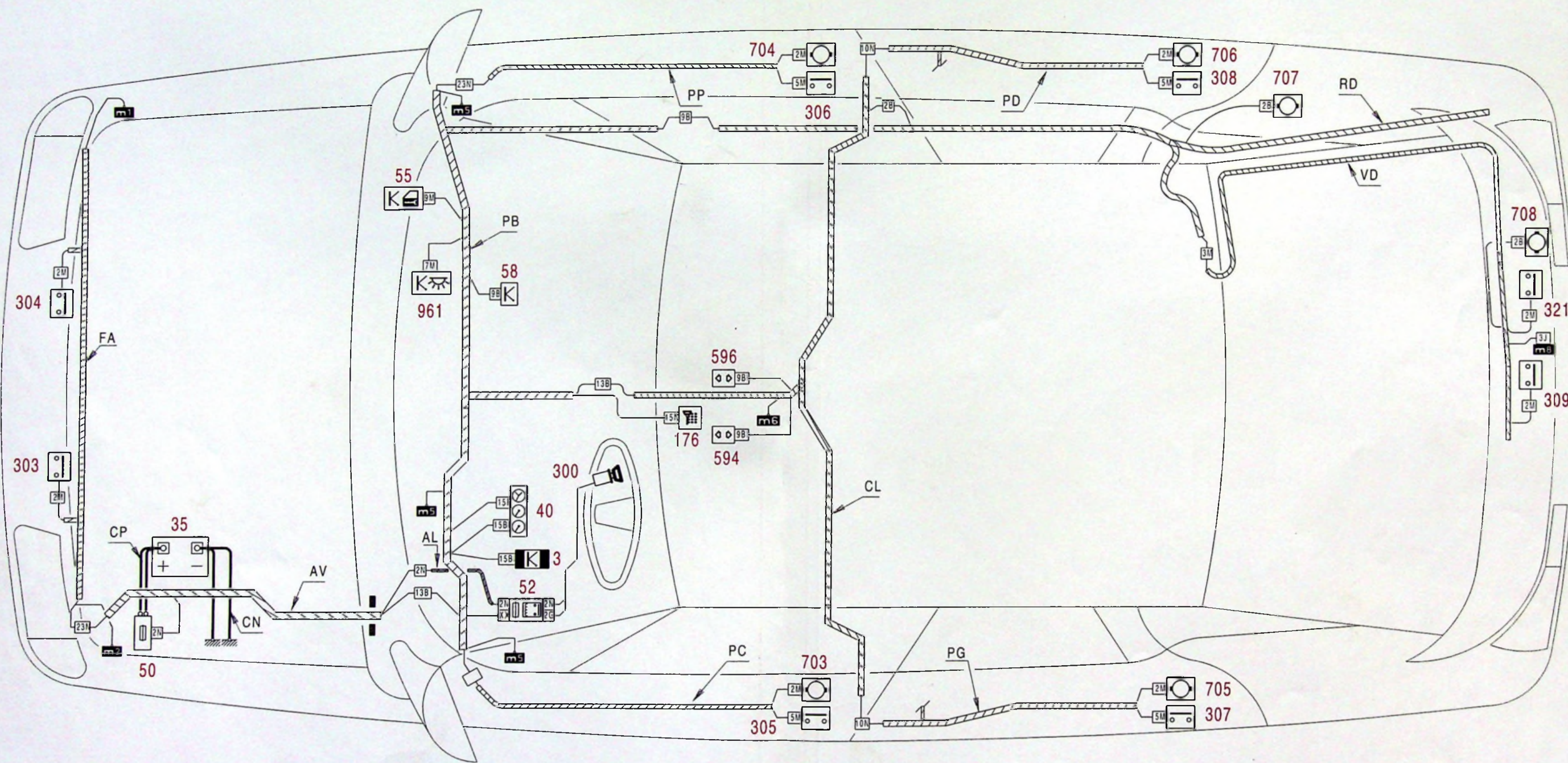



67



XM
672-1/40c

6

7

XM
672-1/40c



67

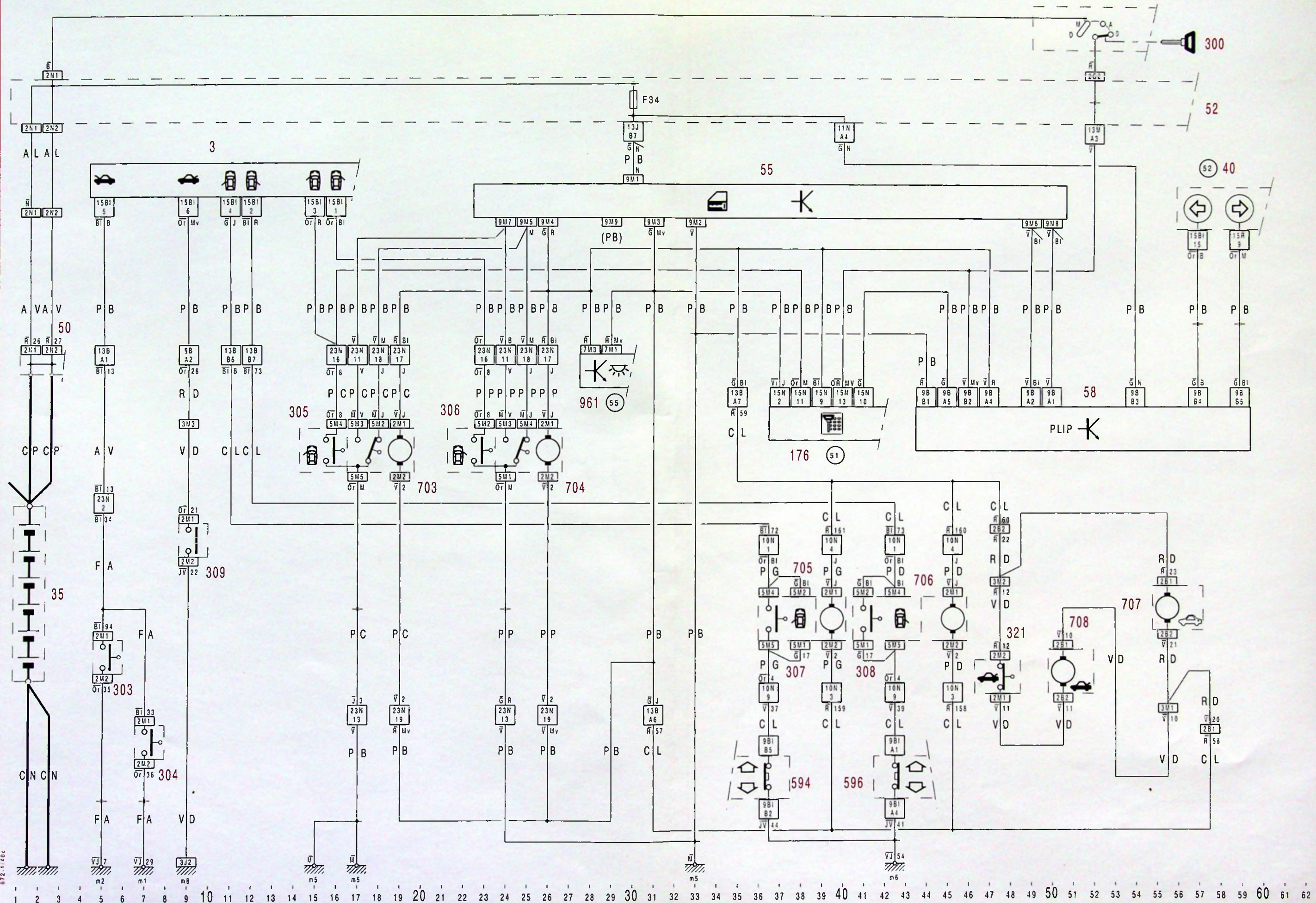



67



XM
672-1/40d

6

7

XM
672-1/40d

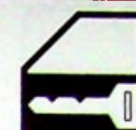

67

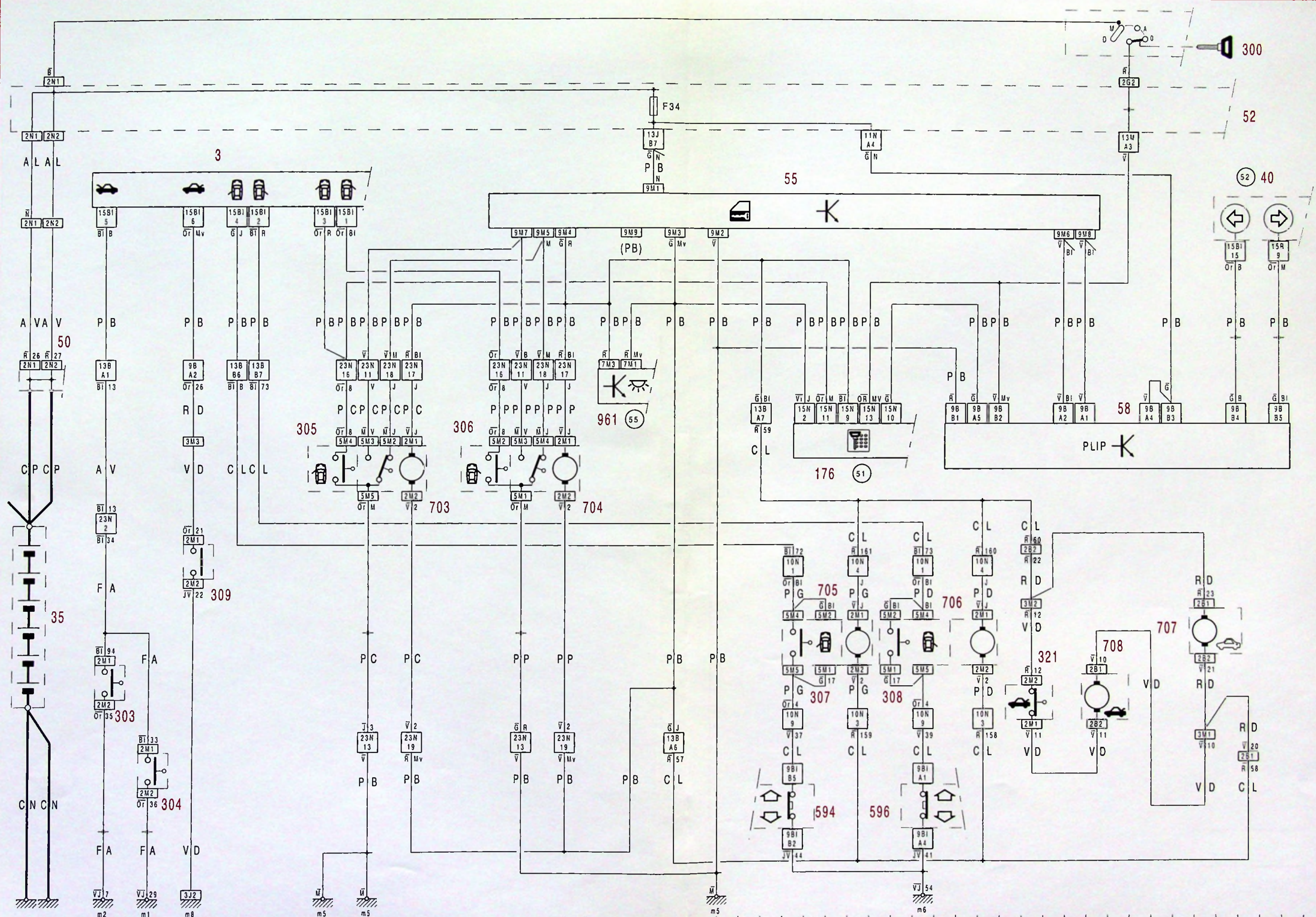

1 2 3 4 5 6 7 8 9 10 11 12 13 14 15 16 17 18 19 20 21 22 23 24 25 26 27 28 29 30 31 32 33 34 35 36 37 38 39 40 41 42 43 44 45 46 47 48 49 50 51 52 53 54 55 56 57 58 59 60 61 62



67



XM
672-1/50

6

7

XM
672-1/50

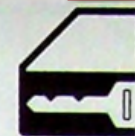

67

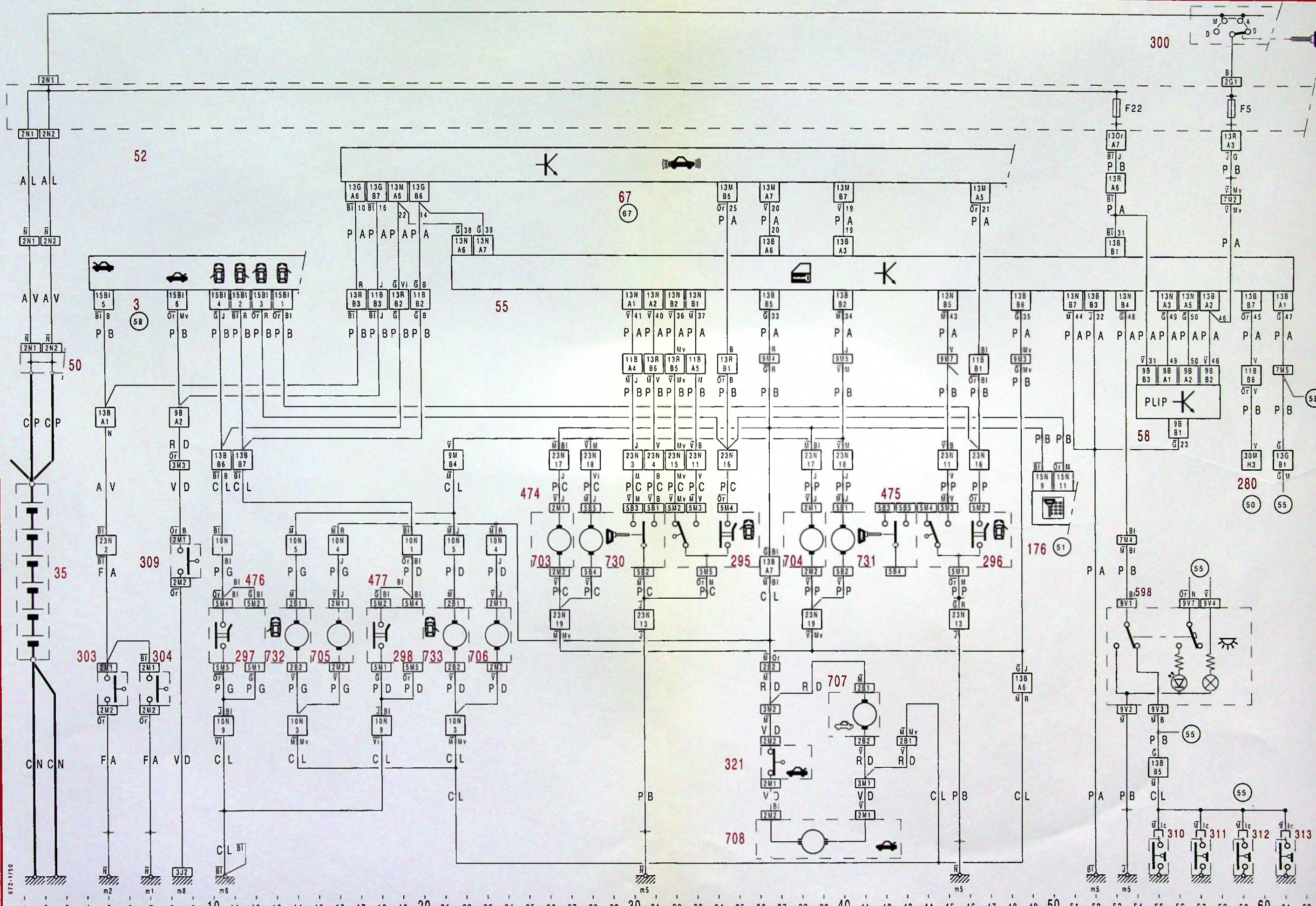

672-1/50

672-1/50



67



XM
672-1/50a

6

7

XM
672-1/50a

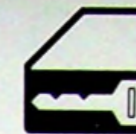

67

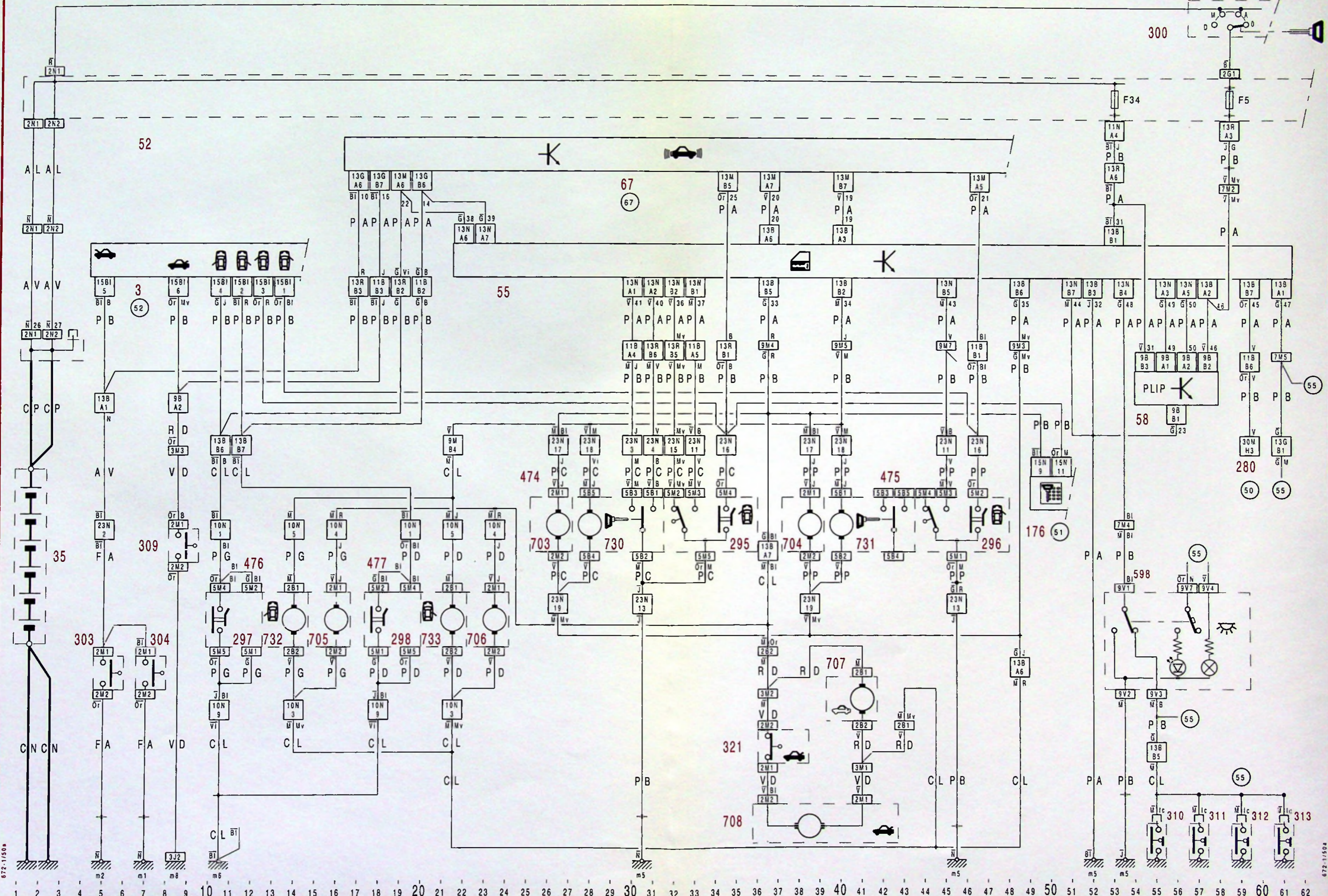



67



XM
672-1/50b

6

7

XM
672-1/50b



67

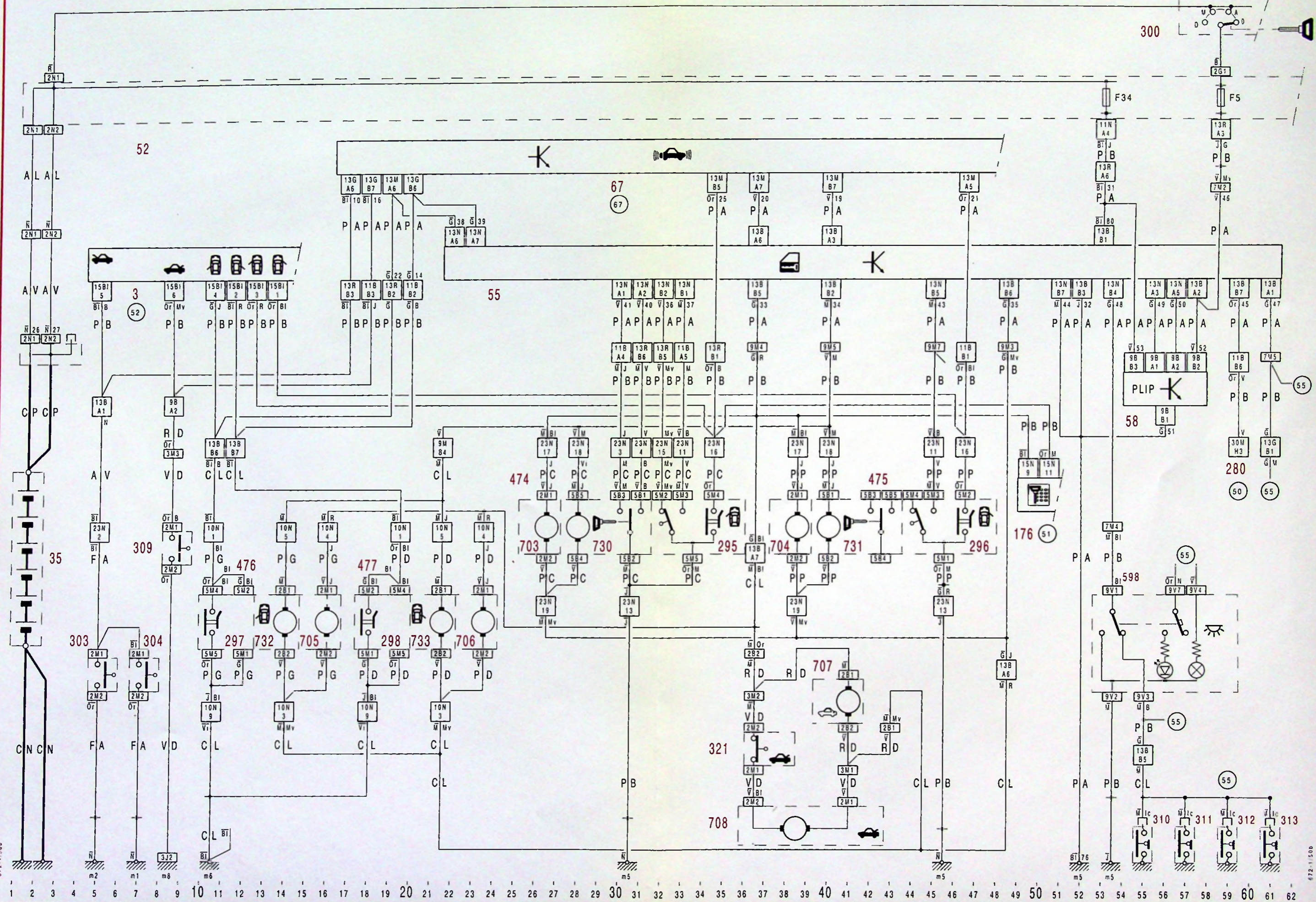

672-1/50b

672-1/50b



67



XM
672-1/50d

3

4

XM
672-1/50d



67

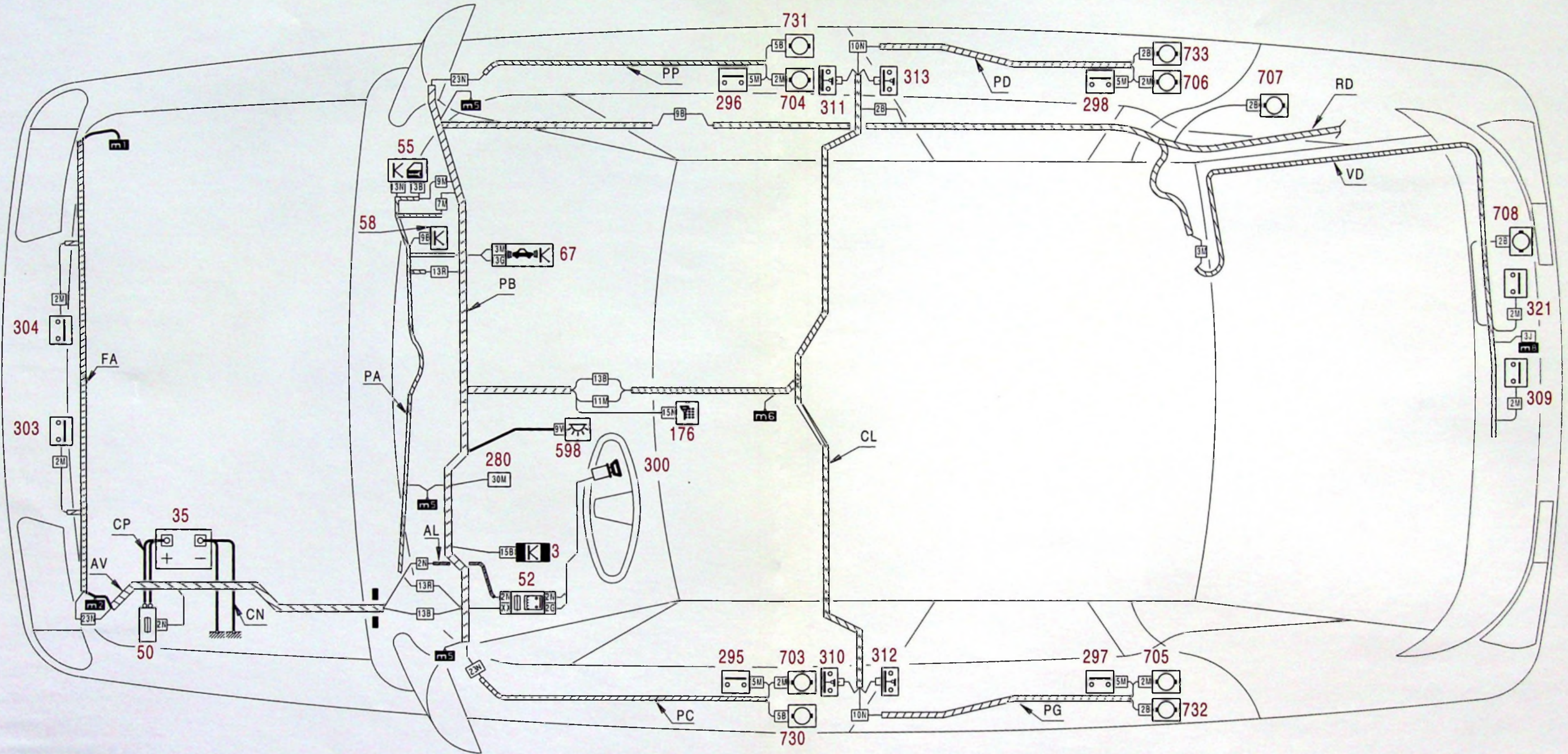



67



XM
672-1/50d

6

7

XM
672-1/50d



67

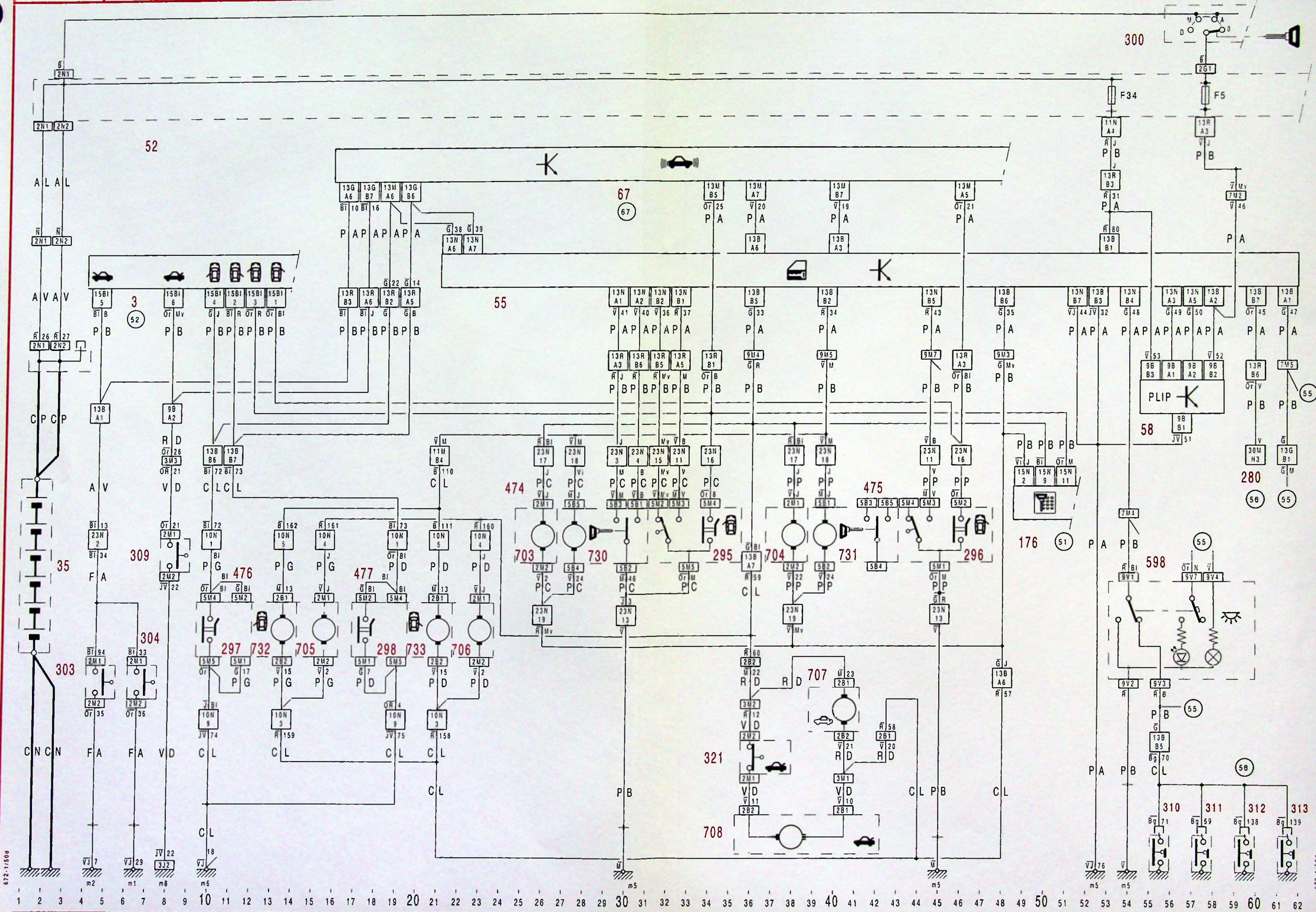



67



XM
672-1/60a

6

7

XM
672-1/60a

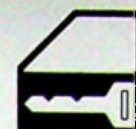

67

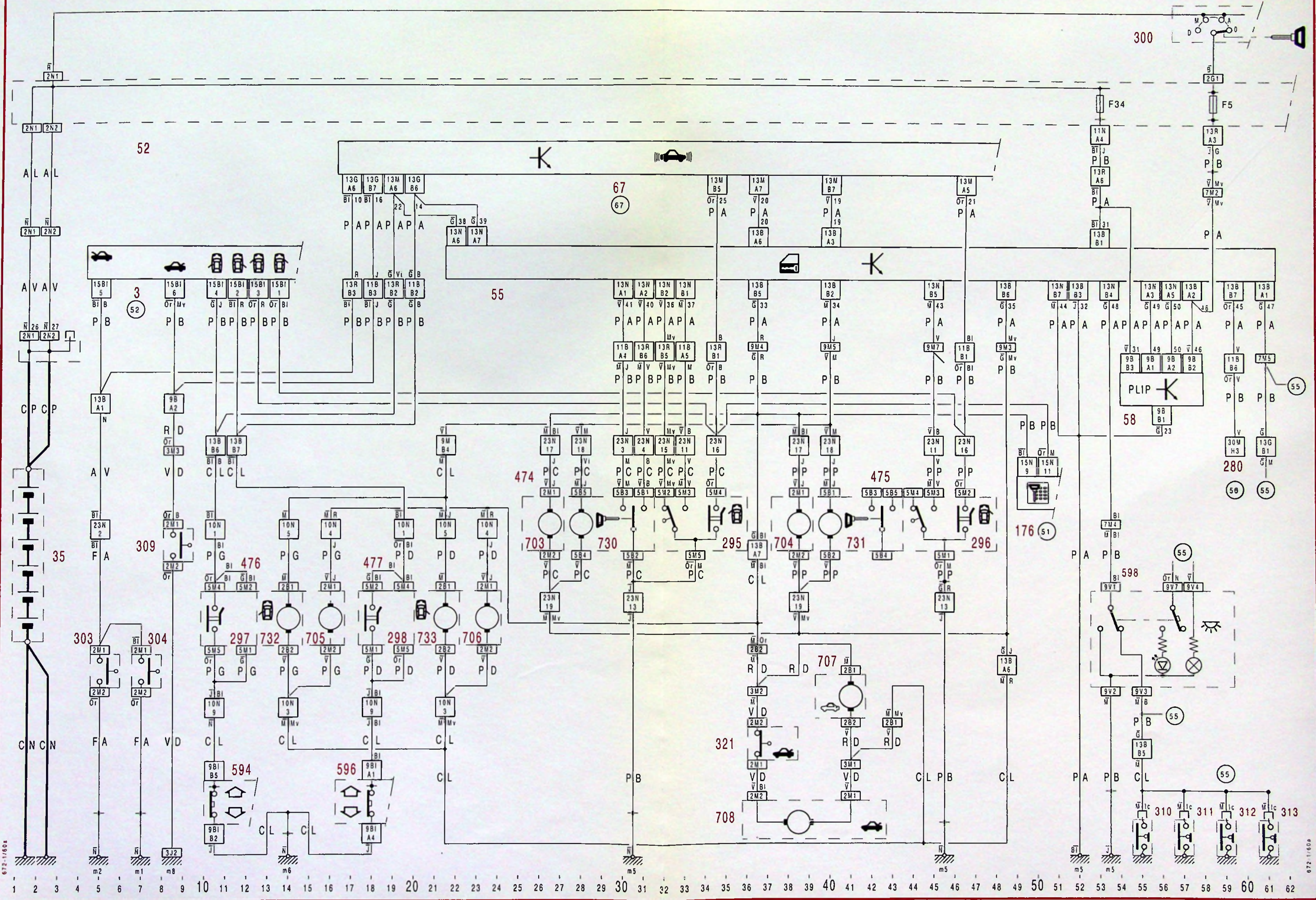

672-1/60a

672-1/60a



67



XM
672-1/60d

6

7

XM
672-1/60d

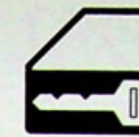

67

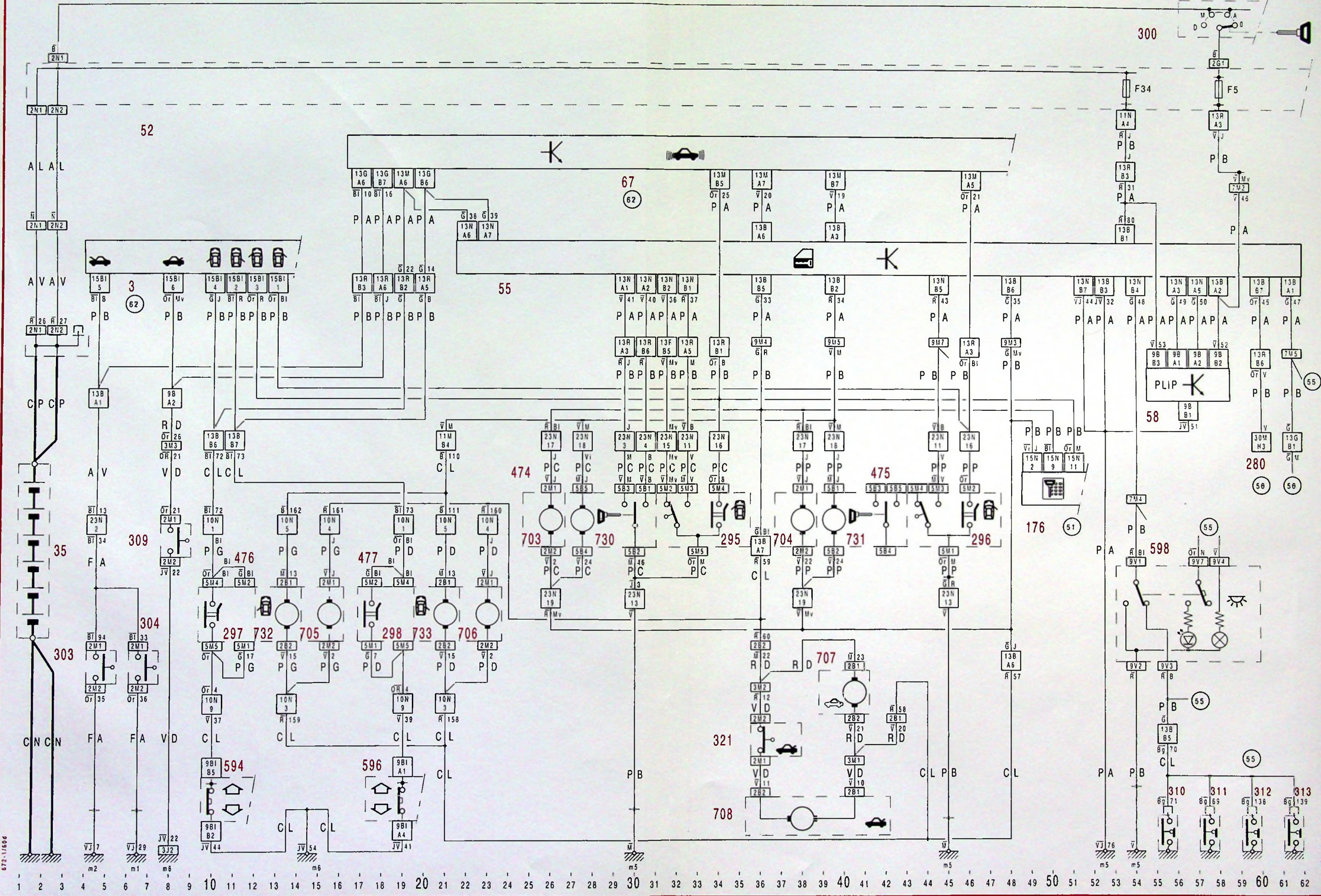

672-1/60d

672-1/60d



67



XM
672-2/20

5

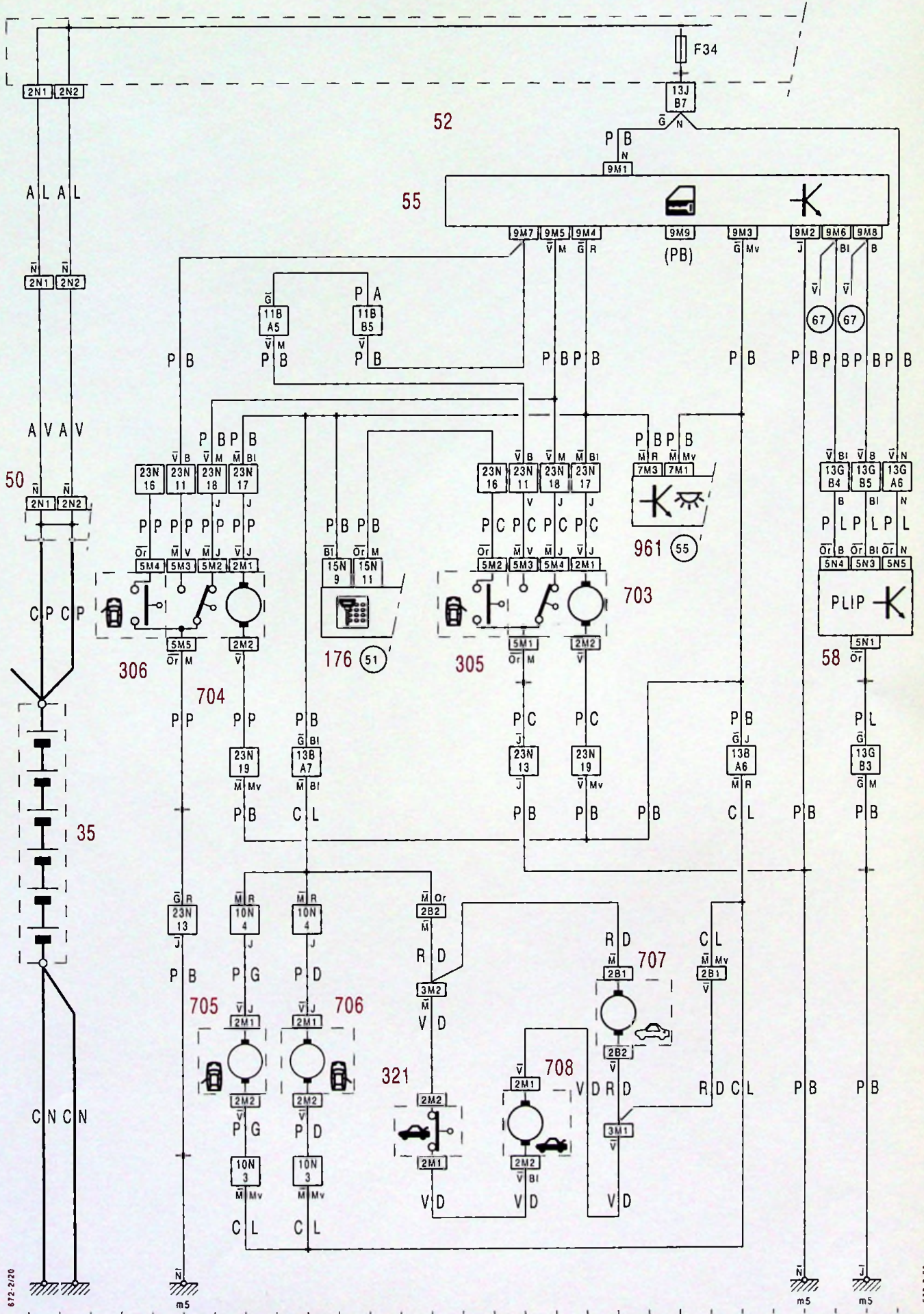

672-2/20

672-2/20

1 2 3 4 5 6 7 8 9 10 11 12 13 14 15 16 17 18 19 20 21 22 23 24 25 26 27 28 29



67



XM
672-2/40

5

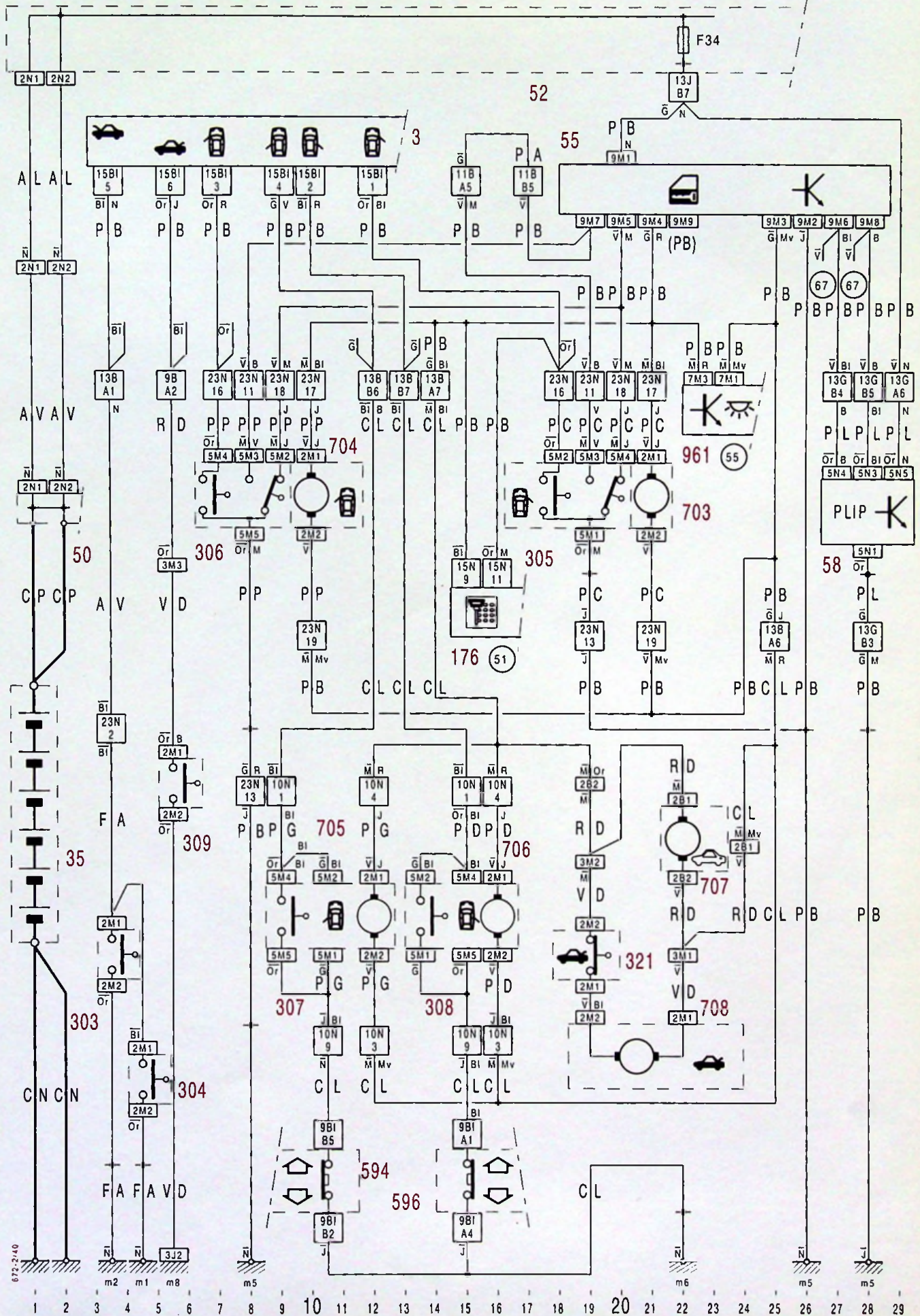



67



XM
672-2/50d

6

7

XM
672-2/50d



67

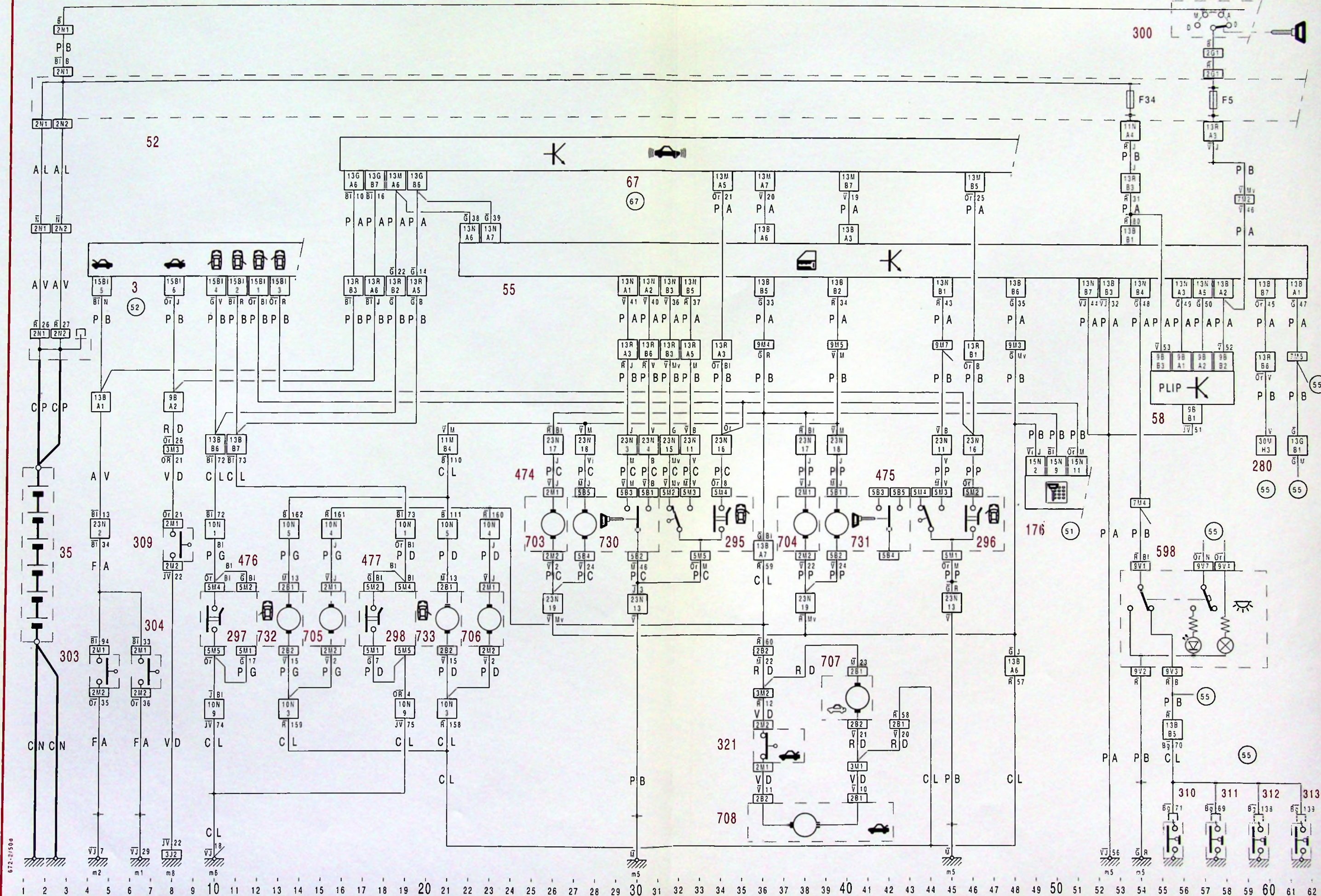

672-2/50d

672-2/50d



67



XM
672-2/50e

6

7

XM
672-2/50e



67

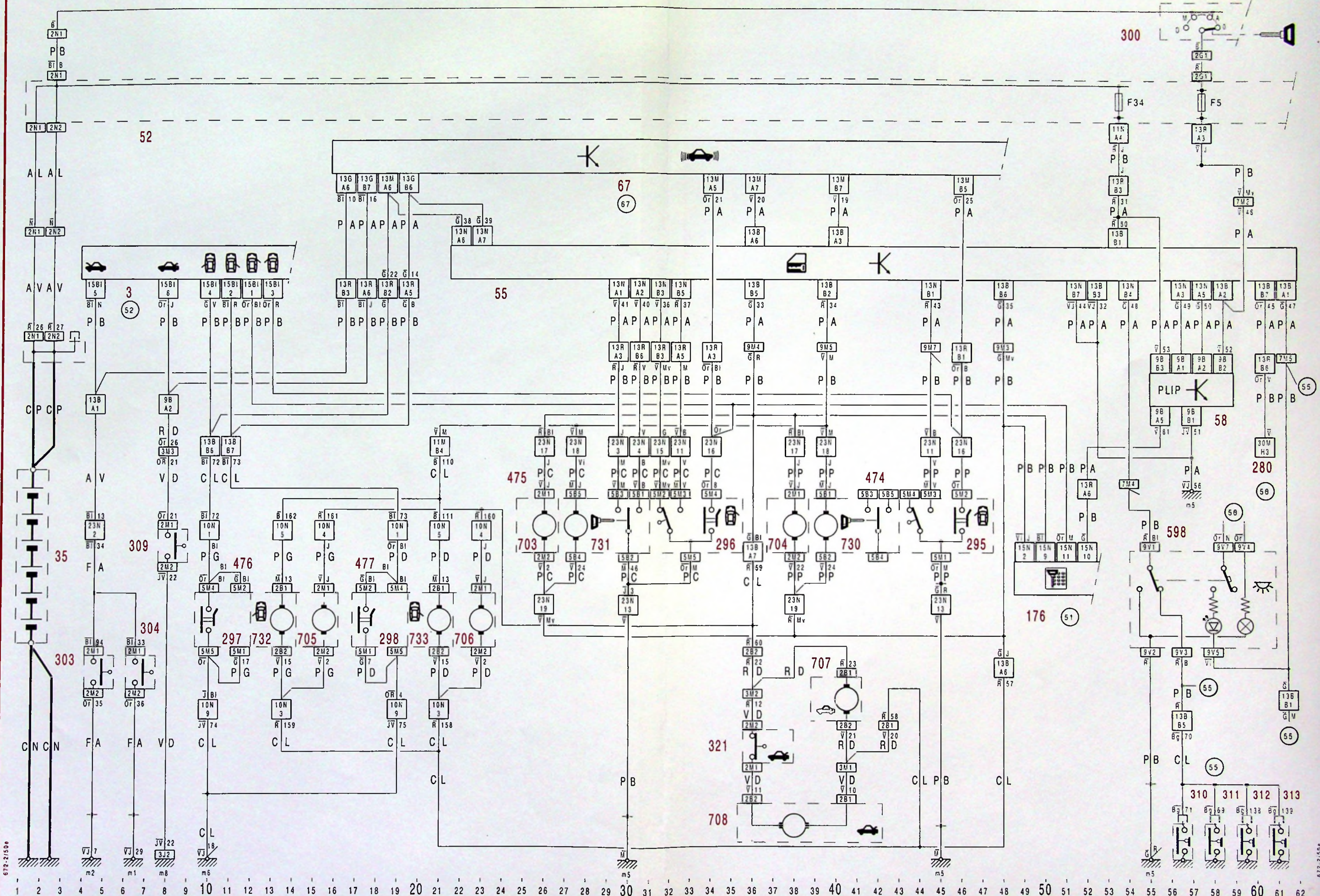

672-2/50e

672-2/50e



67



XM
672-2/60a

6

7

XM
672-2/60a

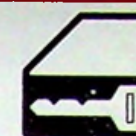

67

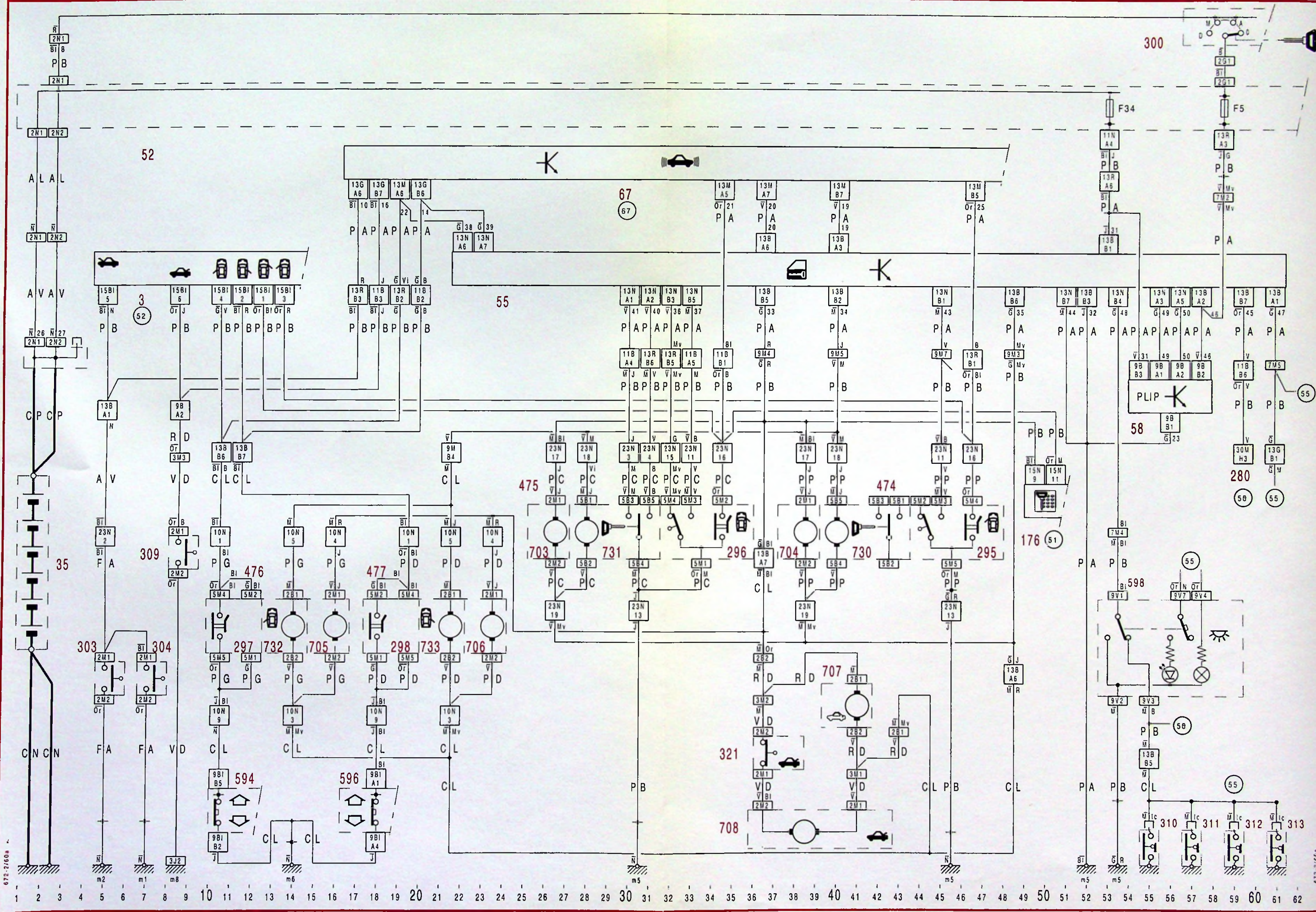



67



XM
672-2/60b

6

7

XM
672-2/60b



67

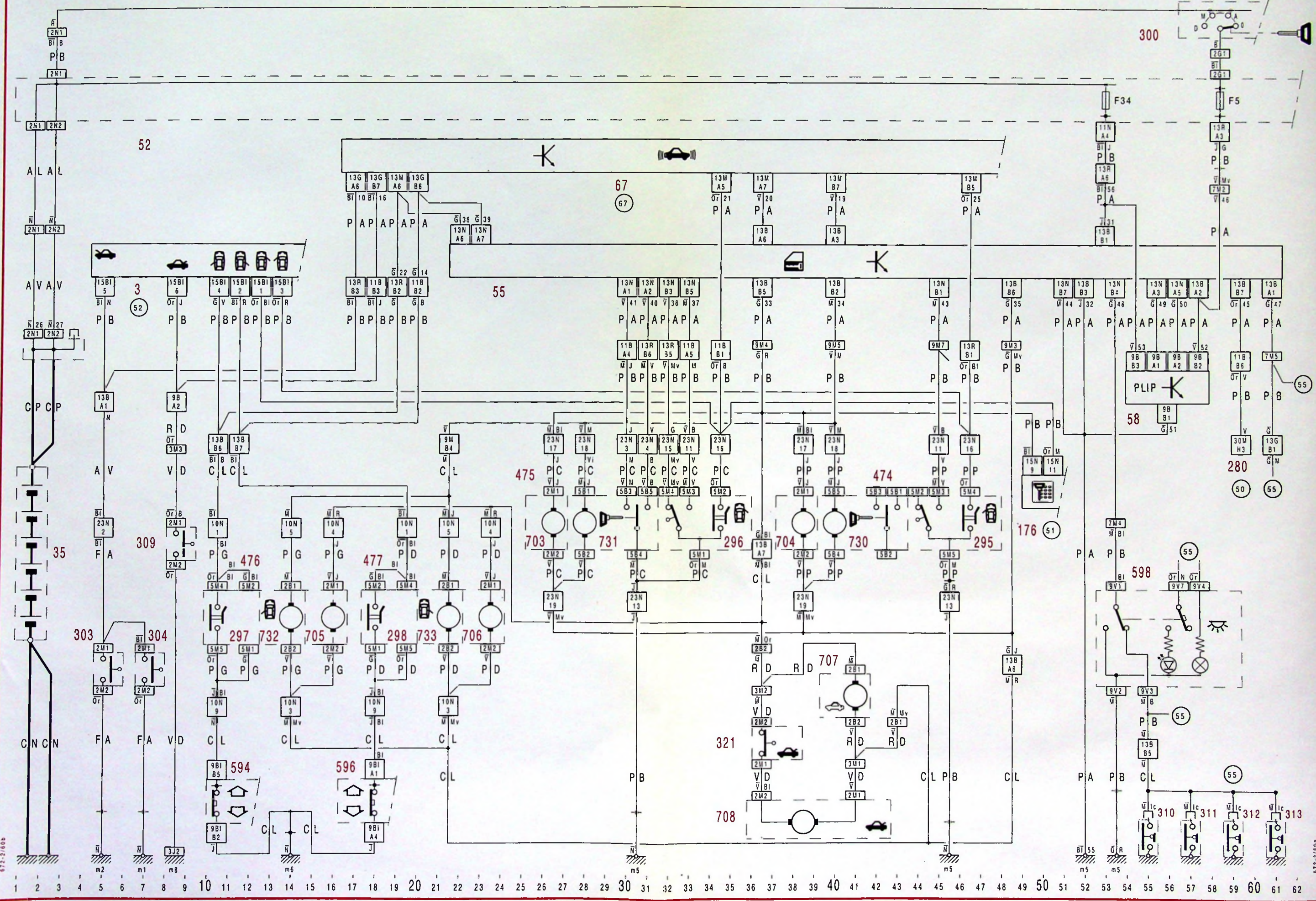

672-2/60b

672-2/60b



67



XM
672-2/60c

6

7

XM
672-2/60c



67

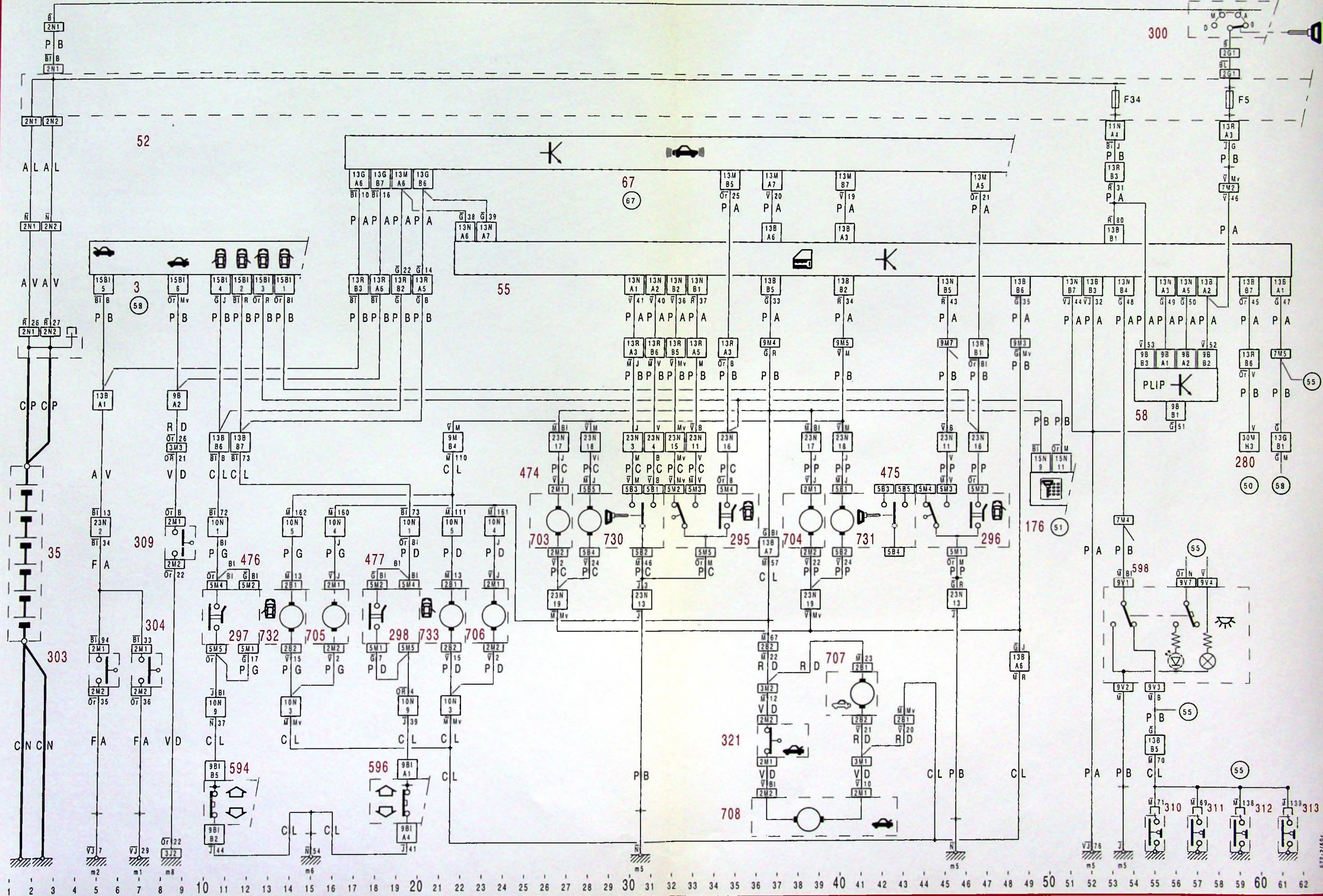



67



XM
672-2/60e

6

7

XM
672-2/60e



67

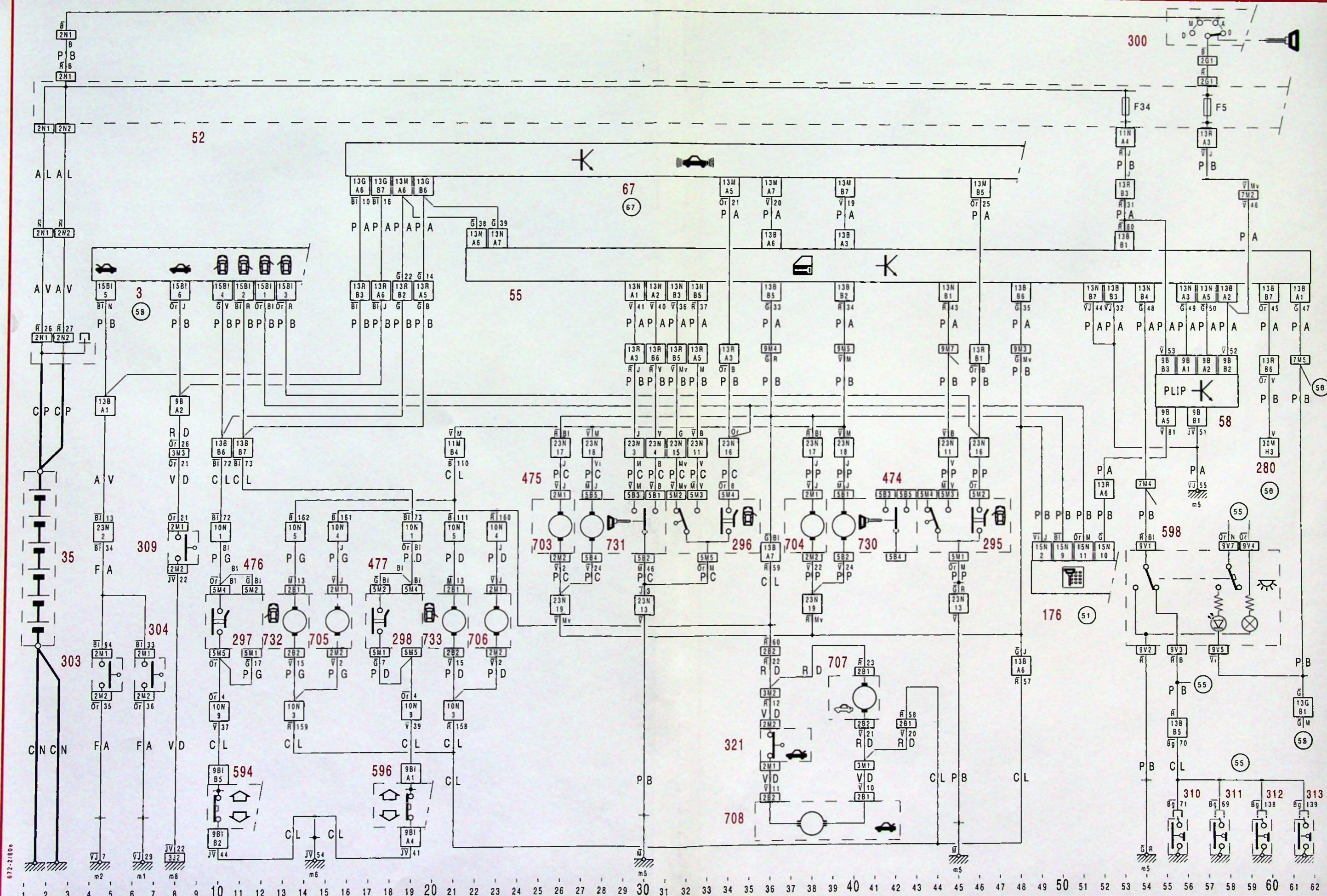

672-2/60e

672-2/60e



67



XM
673-0/20

3

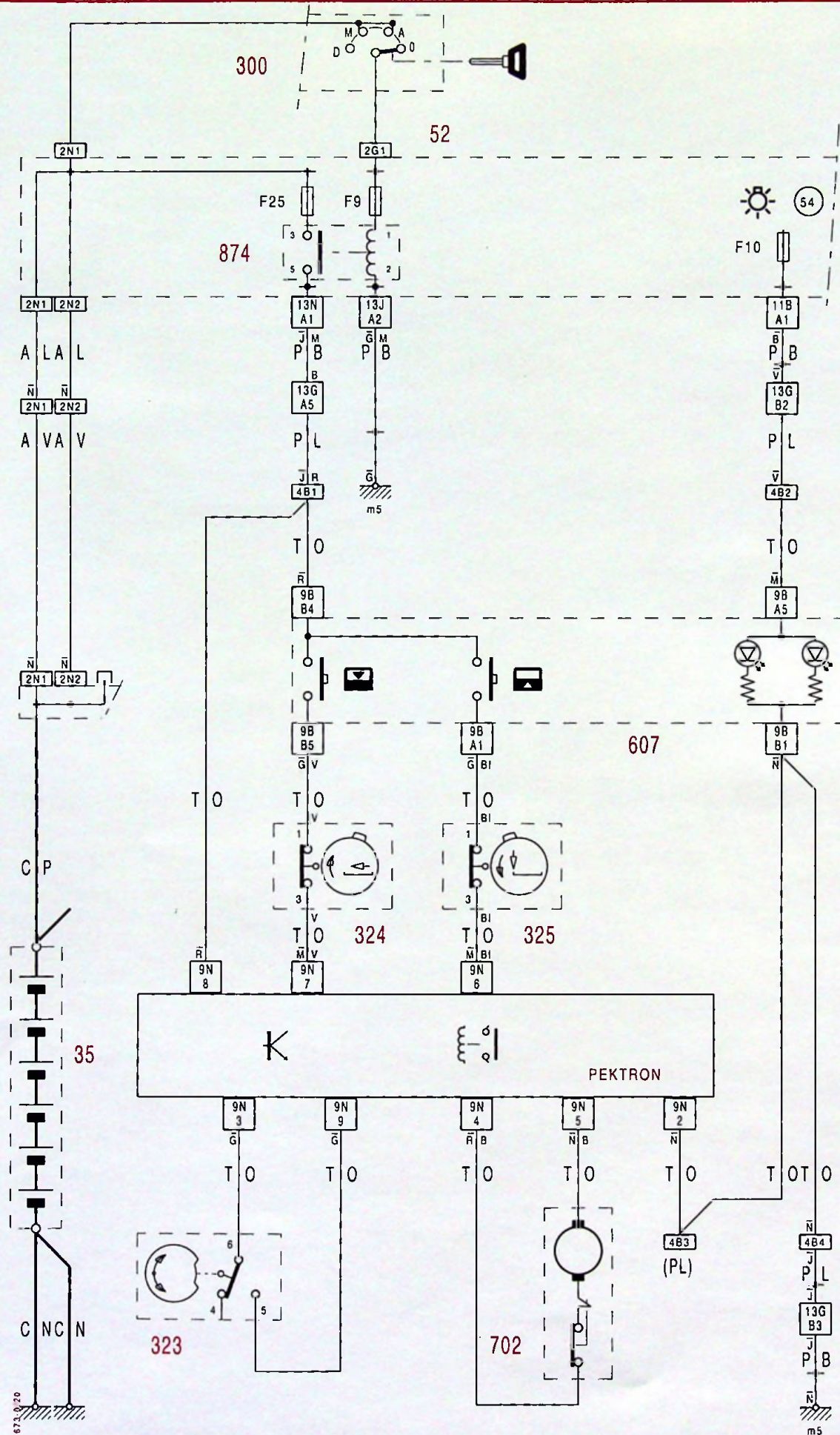

673-0/20

673-0/20



67



XM
673-0/20a

5

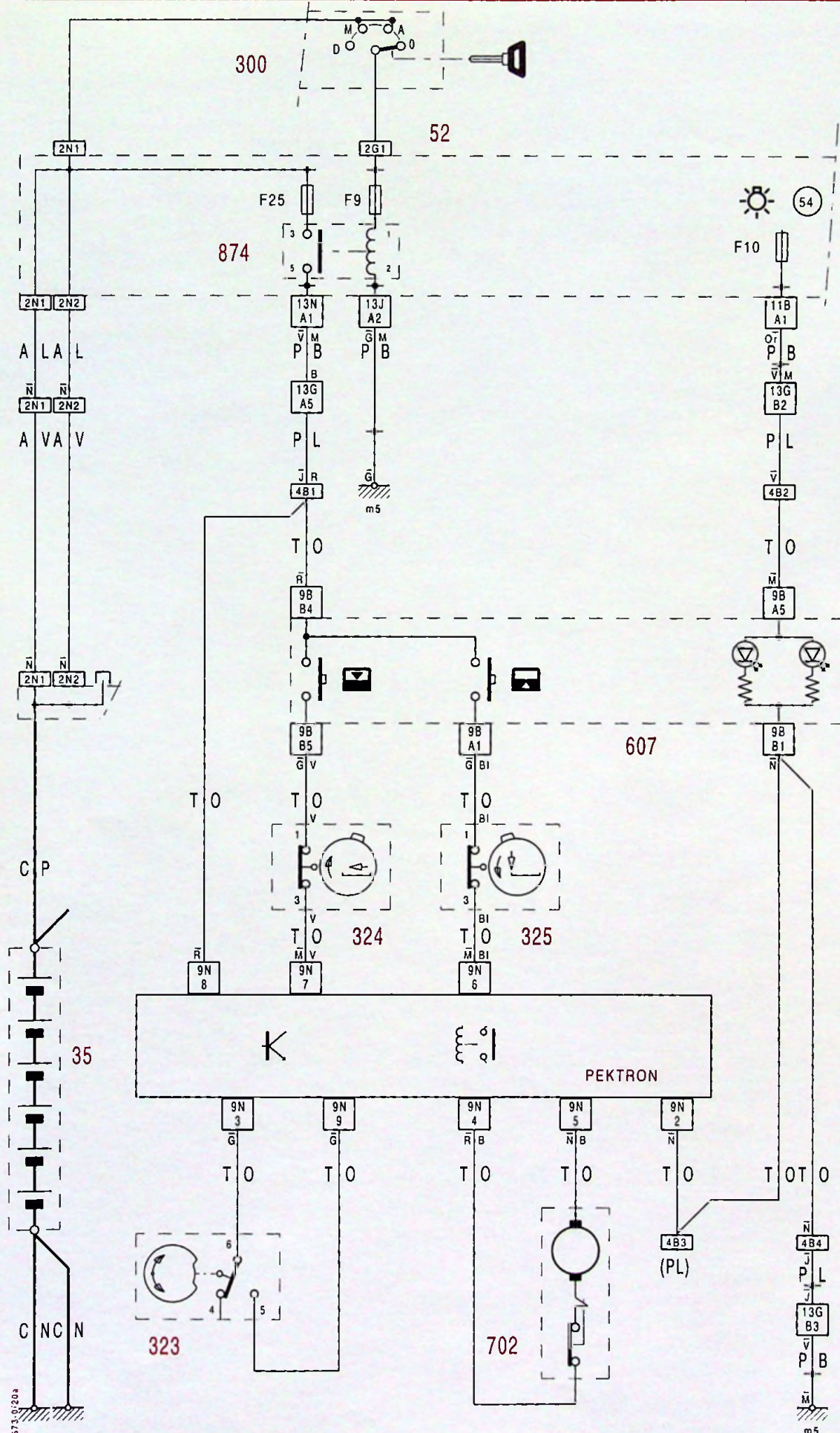

673-0/20a

673-0/20a



67



XM
675-1/10

6

7

XM
675-1/10



67

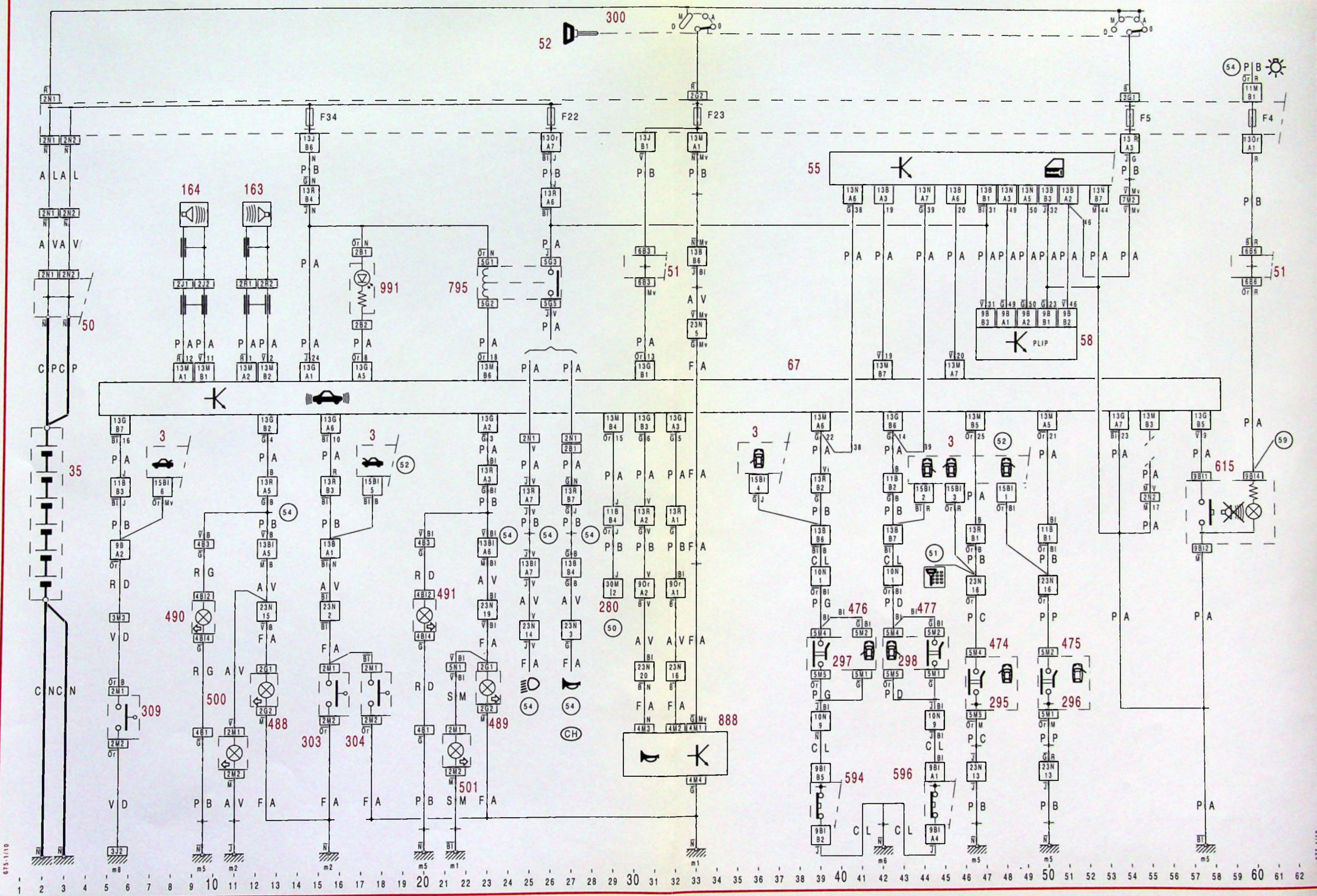

675-1/10

675-1/10



67



XM
675-1/10a

6

7

XM
675-1/10a



67

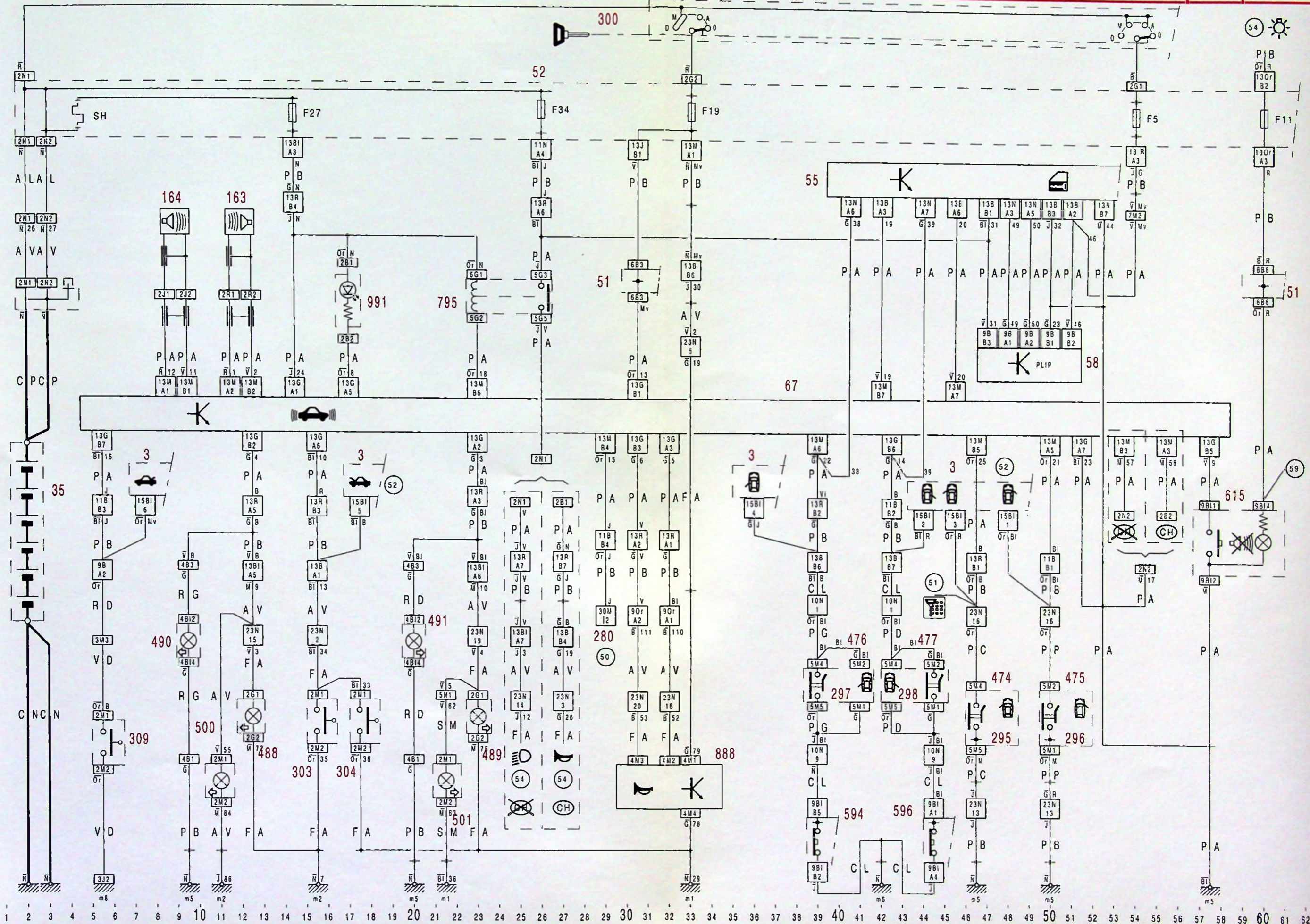



67

XM
675-1/10b

6

7

XM
675-1/10b

67

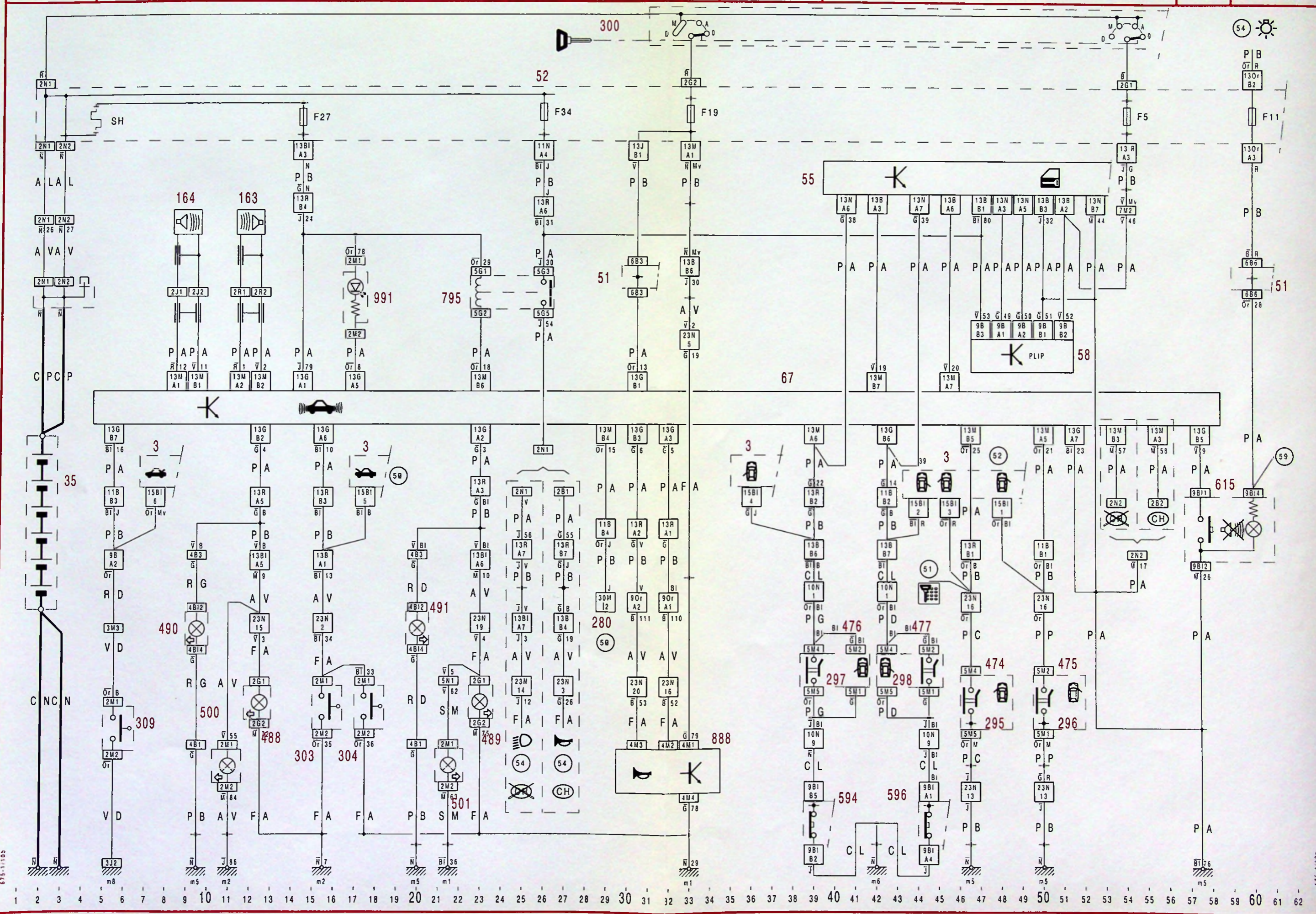

675-1/10b

675-1/10b



67



XM
675-1/10d

3

4

XM
675-1/10d



67

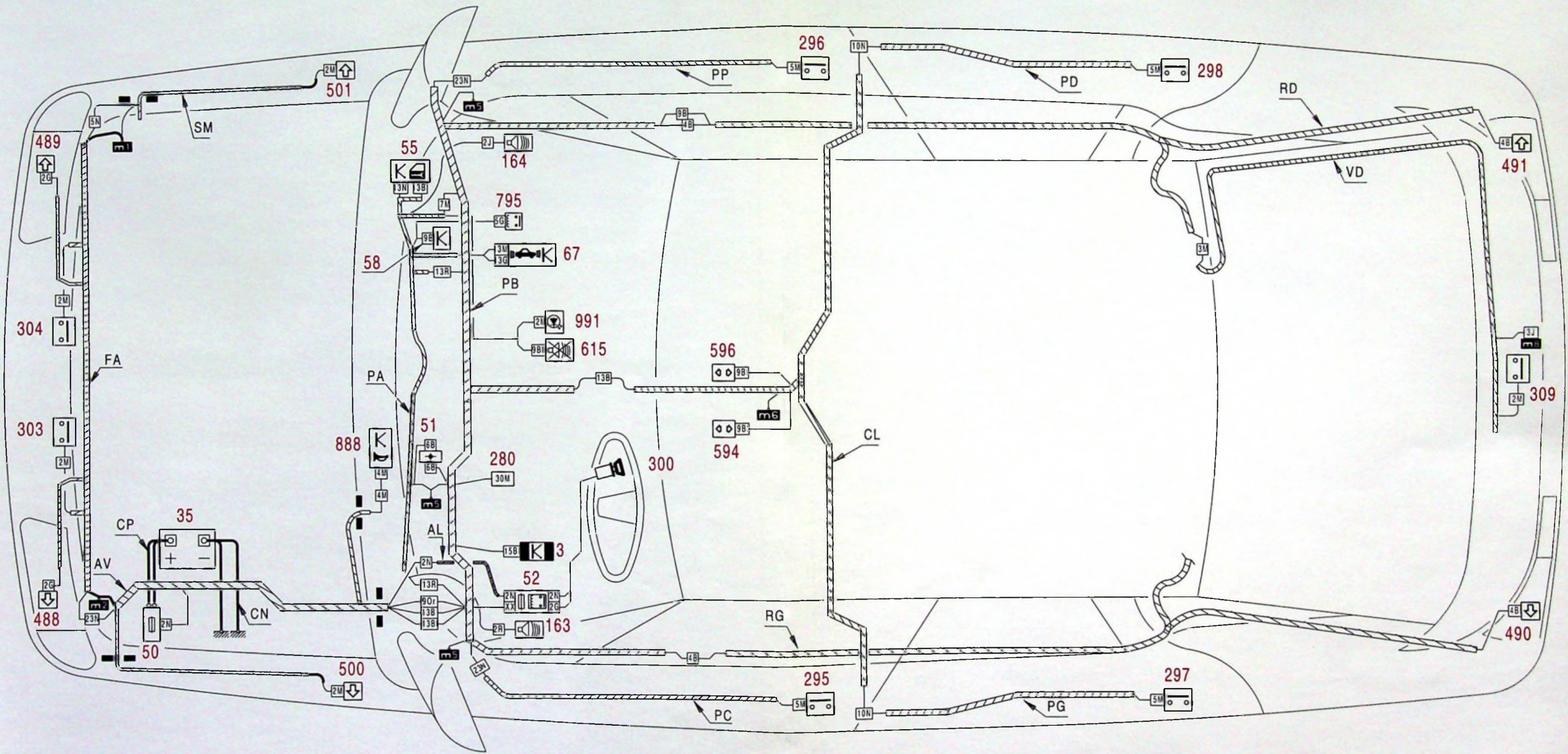

675-1110d

1 2 3 4 5 6 7 8 9 10 11 12 13 14 15 16 17 18 19 20 21 22 23 24 25 26 27 28 29 30 31 32 33 34 35 36 37 38 39 40 41 42 43 44 45 46 47 48 49 50 51 52 53 54 55 56 57 58 59 60 61 62

675-1110d



67



XM
675-1/10d

6

7

XM
675-1/10d



67

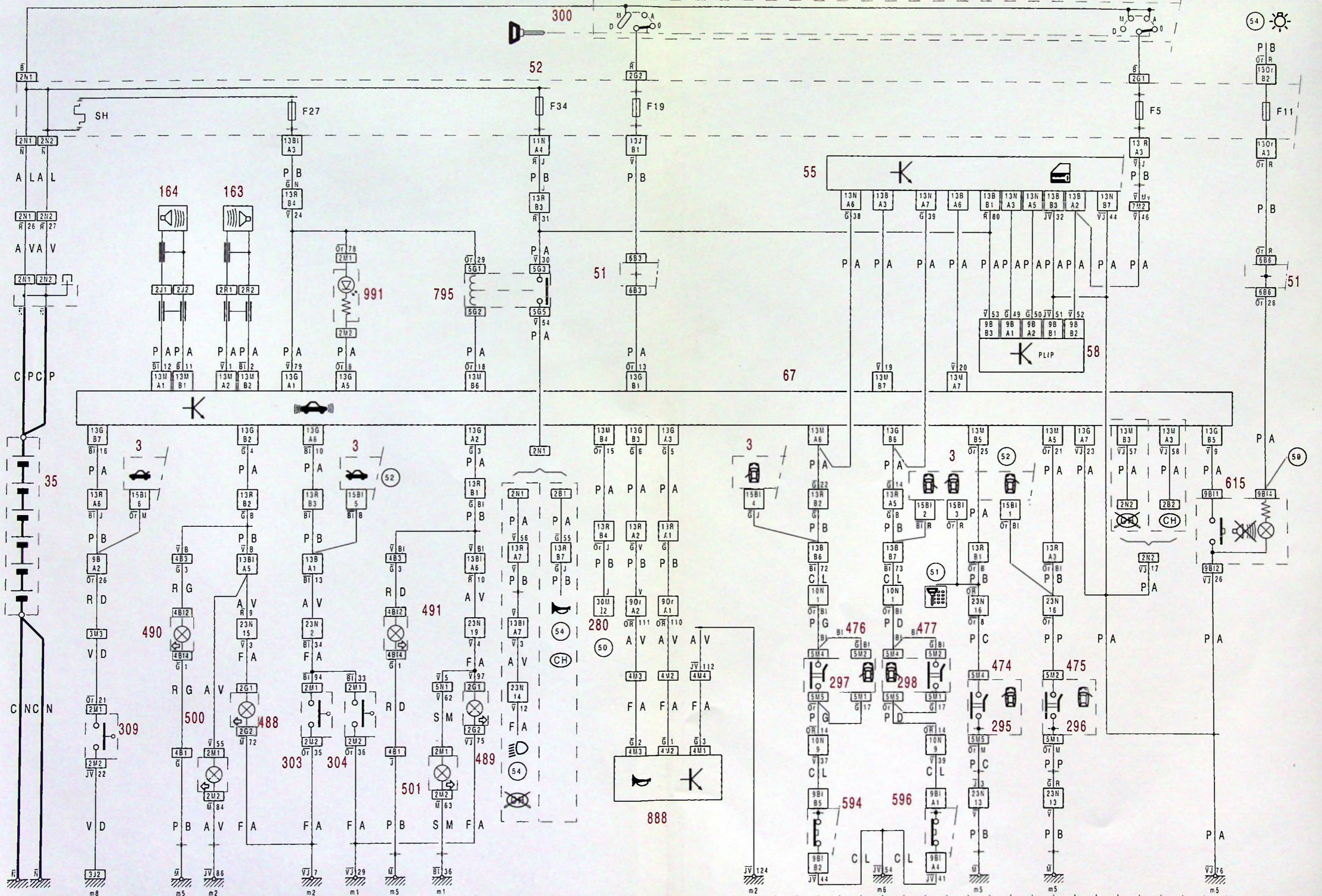



67



XM
675-2/10

6

7

XM
675-2/10



67

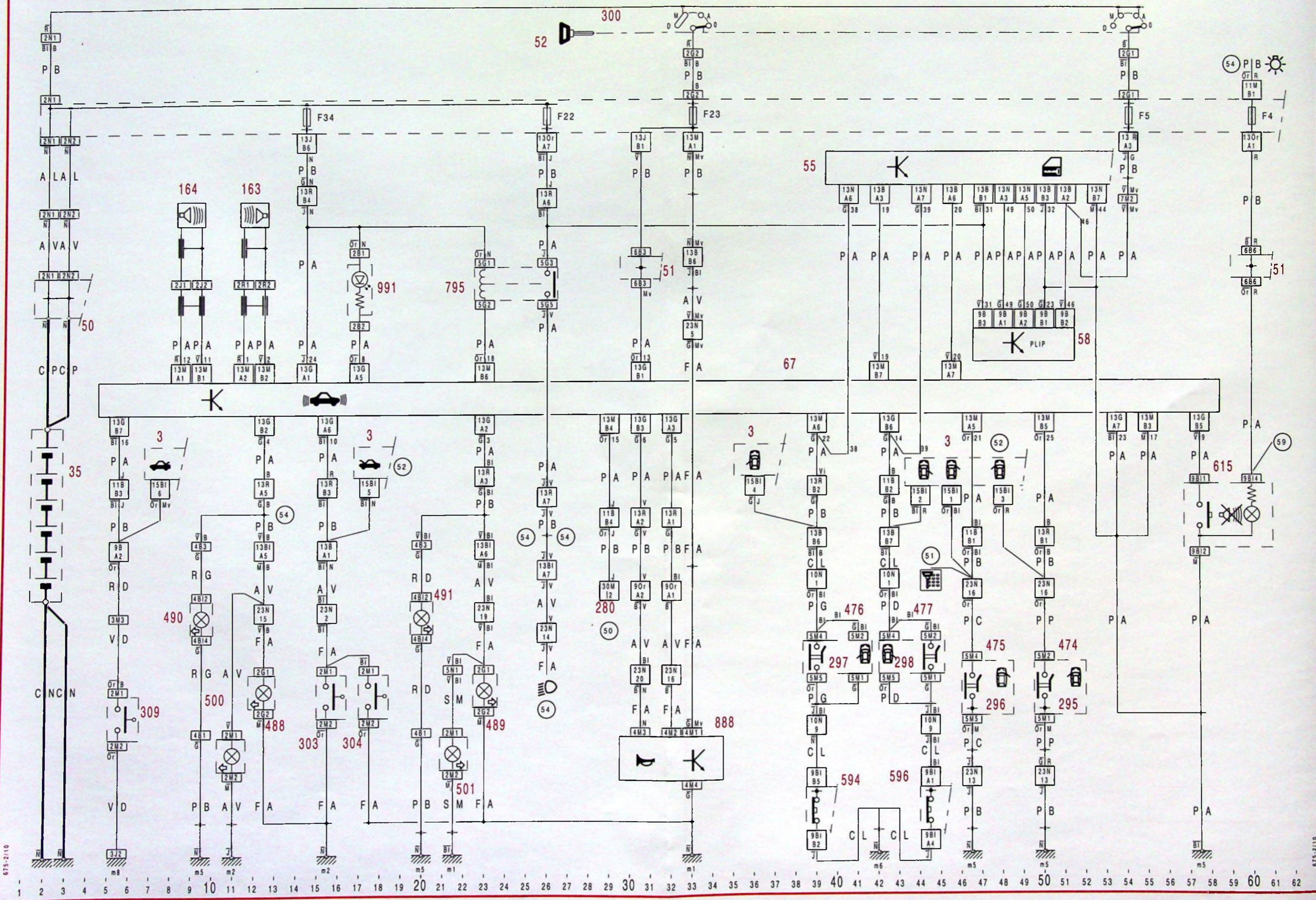

675-2/10

675-2/10



67



XM
675-2/10a

6

7

XM
675-2/10a



67

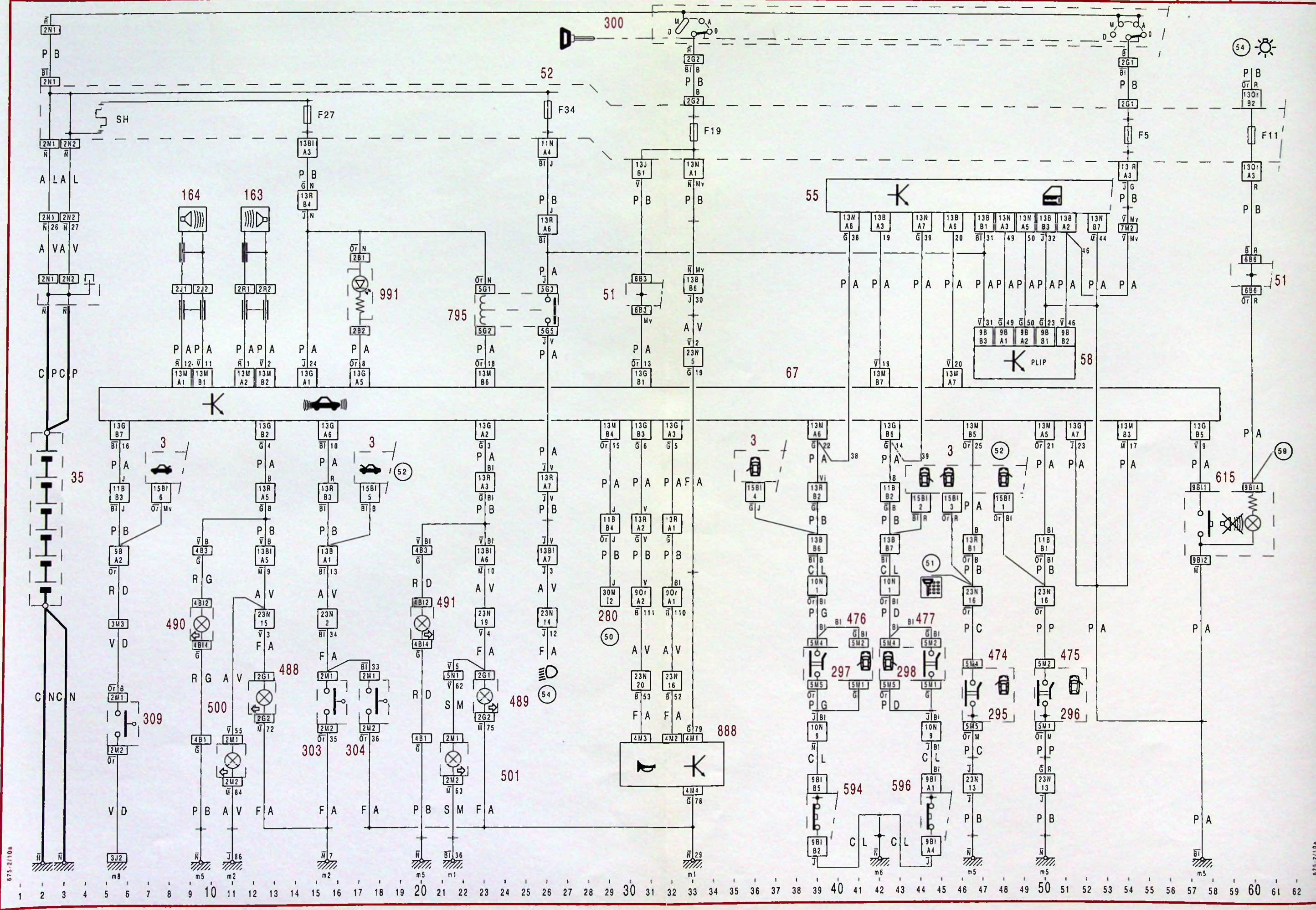

675-2/10a

675-2/10a



67



XM
675-2/10c

6

7

XM
675-2/10c



67

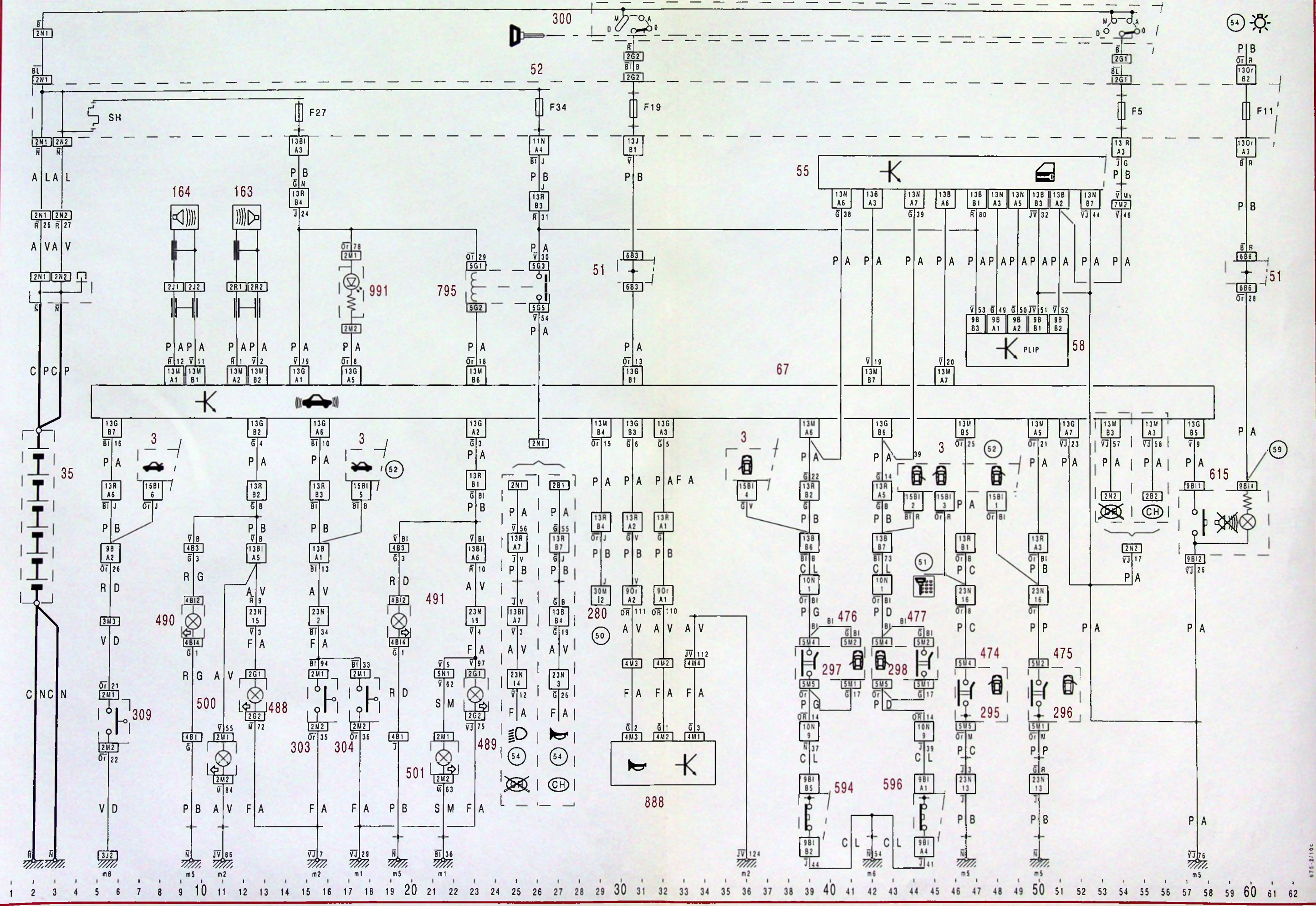

1 2 3 4 5 6 7 8 9 10 11 12 13 14 15 16 17 18 19 20 21 22 23 24 25 26 27 28 29 30 31 32 33 34 35 36 37 38 39 40 41 42 43 44 45 46 47 48 49 50 51 52 53 54 55 56 57 58 59 60 61 62



67



XM
675-2/10d

6

7

XM
675-2/10d



67

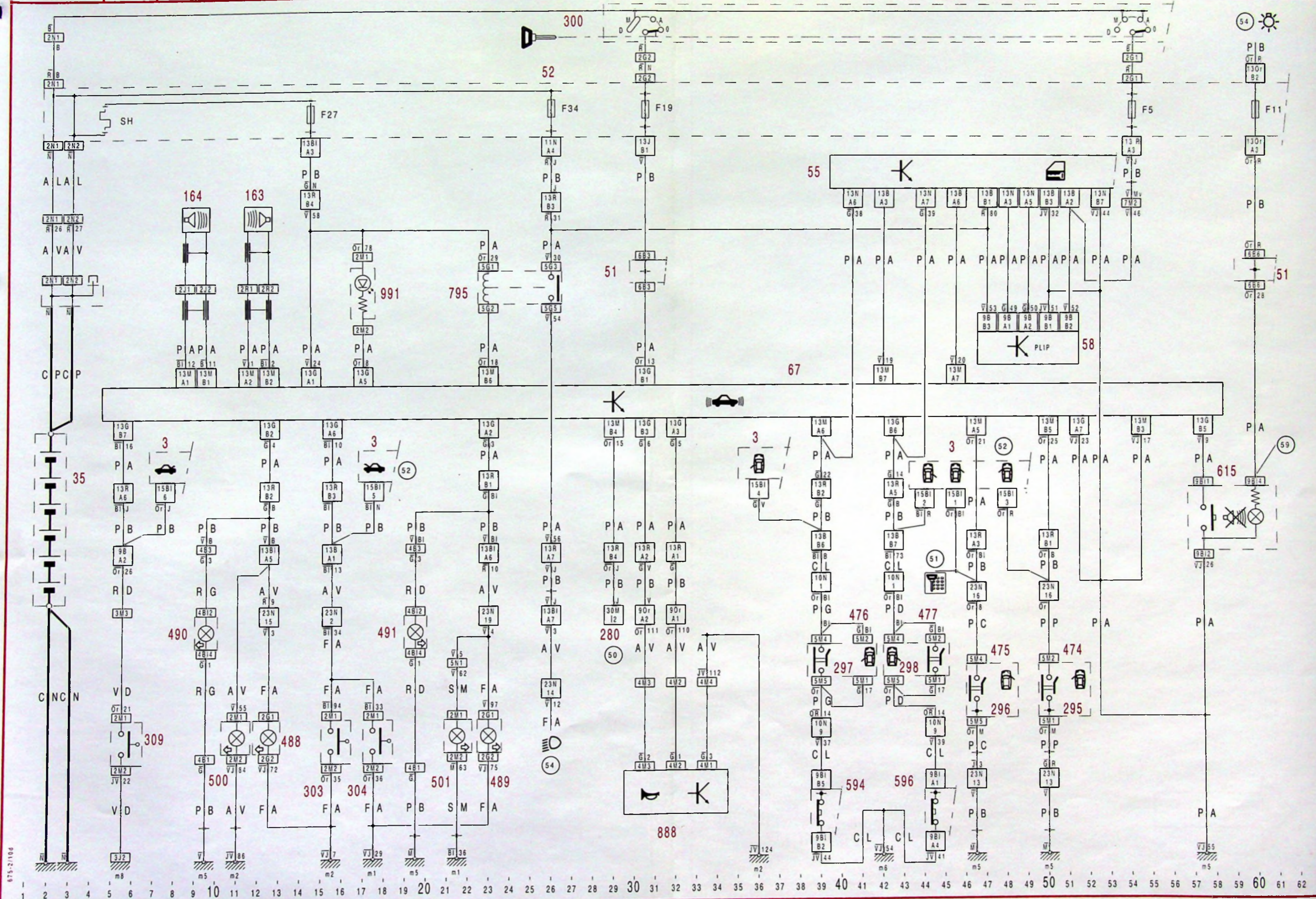

675-2/10d

675-2/10d