



63



XM
630-000/1

1

FONCTION : ASSISE

NOMENCLATURE DES PIECES
LISTE DES SCHEMAS



63

NOMENCLATURE DES PIECES

XM
630-000/1

3

Rep.	Désignation	Fonct.	Rep.	Désignation	Fonct.
15	Alternateur	53			
35	Batterie	TT			
52	Boîtier interconnexions	TT			
71	Boîtier régulation siège chauffant avant gauche	63			
72	Boîtier régulation siège chauffant avant droit	63			
73	Boîtier régulation siège chauffant arrière gauche	63			
74	Boîtier régulation siège chauffant arrière droit	63			
280	Connecteur diagnostic	TT			
300	Contacteur antivol	TT			
310	Contact feuillure porte avant gauche	55			
311	Contact feuillure porte avant droite	55			
312	Contact feuillure porte arrière gauche	55			
313	Contact feuillure porte arrière droite	55			
580	Interrupteur avance siège conducteur	63			
581	Interrupteur avance siège passager	63			
584	Interrupteur dossier conducteur	63			
585	Interrupteur dossier passager	63			
600	Interrupteur réhausse siège conducteur	63			
601	Interrupteur siège chauffant conducteur	63			
602	Interrupteur siège chauffant passager	63			
603	Interrupteur siège chauffant arrière gauche	63			
604	Interrupteur siège chauffant arrière droit	63			
605	Interrupteur d'accoudoir central	63			
690	Moteur d'avance siège conducteur	63			
691	Moteur d'avance siège passager	63			
692	Moteur de dossier siège conducteur	63			
693	Moteur de dossier siège passager	63			
701	Moteur de réhausse siège conducteur	63			
709	Moteur d'accoudoir central	63			
810	Relais lève-vitre arrière	67			
811	Relais manœuvre siège conducteur	63			
812	Relais manœuvre siège passager	63			
817	Relais sièges chauffants avant	63			
824	Relais sièges chauffants arrière et/ou toit ouvrant	63			
837	Relais temporisateur d'éclairage	55			
841	Relais de réalimentation lève-vitre	67			
848	Relais information moteur tournant	TT			
850	Résistance assise arrière gauche	63			
851	Résistance assise arrière droite	63			
852	Résistance dossier arrière gauche	63			
853	Résistance dossier arrière droite	63			
854	Résistance siège avant gauche	63			
855	Résistance siège avant droit	63			

4

XM
630-000/1CHAPITRE ASSISE
LISTE DES SCHEMAS

63



REGLAGE SIEGES

NUMERO	DIRECTION	VALIDITE	DESIGNATION
630-1/20	Gauche	6383 → → 7084	TOUS PAYS SAUF N-S-SF Sièges à commande électrique XMS101
630-1/20a	Gauche	7084 → → 7329	Evolution a : Evolution faisceaux CL et PB XMK001
630-1/20b	Gauche	7329 →	Evolution b : Evolution faisceaux PB, CL, SC et SP XMK005
630-1/21	Gauche	7084 → → 7329	VALABLE N-S-SF Sièges à commande électrique XMK002
630-1/21a	Gauche	7329 →	Evolution a : Evolution faisceaux PB, CL, SC et SP XMK006

SIEGES CHAUFFANTS

NUMERO	DIRECTION	VALIDITE	DESIGNATION
631-1/20	Gauche	6383 → → 6749	TOUS TYPES Sièges chauffants XMS102
631-1/20a	Gauche	6749 → → 7084	Evolution a : Evolution boîte fusibles XMS213
631-1/20b	Gauche	7084 → → 7329	Evolution b : Evolution faisceaux CL et PB XMK003
631-1/20c	Gauche	7329 →	Evolution c : Evolution faisceaux PB, CL, SC et SP XMK007

ACCOUDOIR CENTRAL

NUMERO	DIRECTION	VALIDITE	DESIGNATION
632-1/20	Gauche	6383 → → 6749	TOUS TYPES Accoudoir central à commande électrique XMS103
632-1/20a	Gauche	6749 → → 7084	Evolution a : Evolution boîte fusibles XMS214
632-1/20b	Gauche	7084 → → 7329	Evolution b : Evolution faisceaux CL et PB XMK004
632-1/20c	Gauche	7329 → → 7847	Evolution c : Evolution faisceaux CL et PB XMK008
632-1/20d	Gauche	7847 →	Evolution d : Evolution faisceaux CL XMK009



63



XM
630-1/20

5

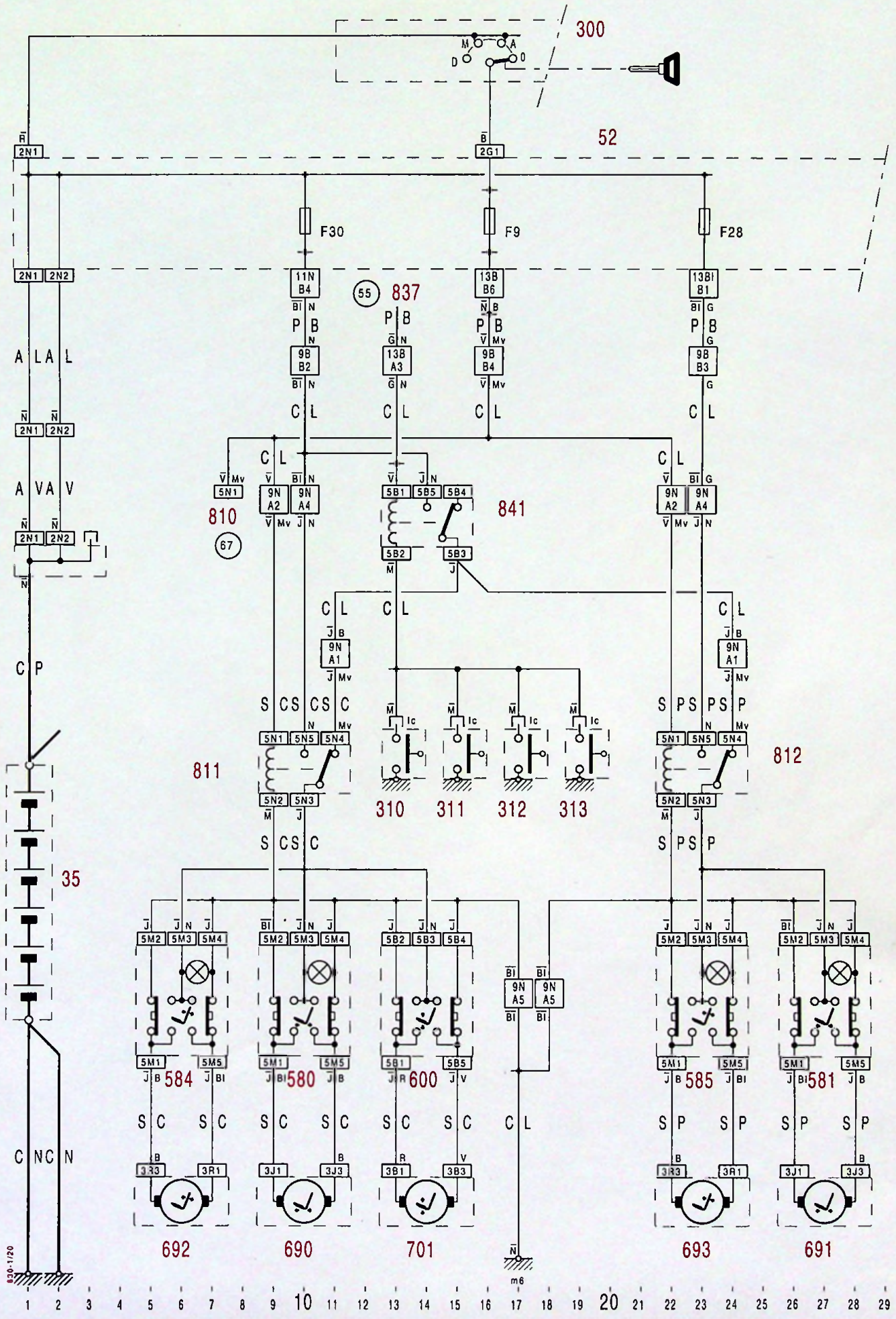

630-1/20

630-1/20



63

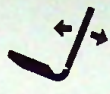

XM
630-1/20a

5

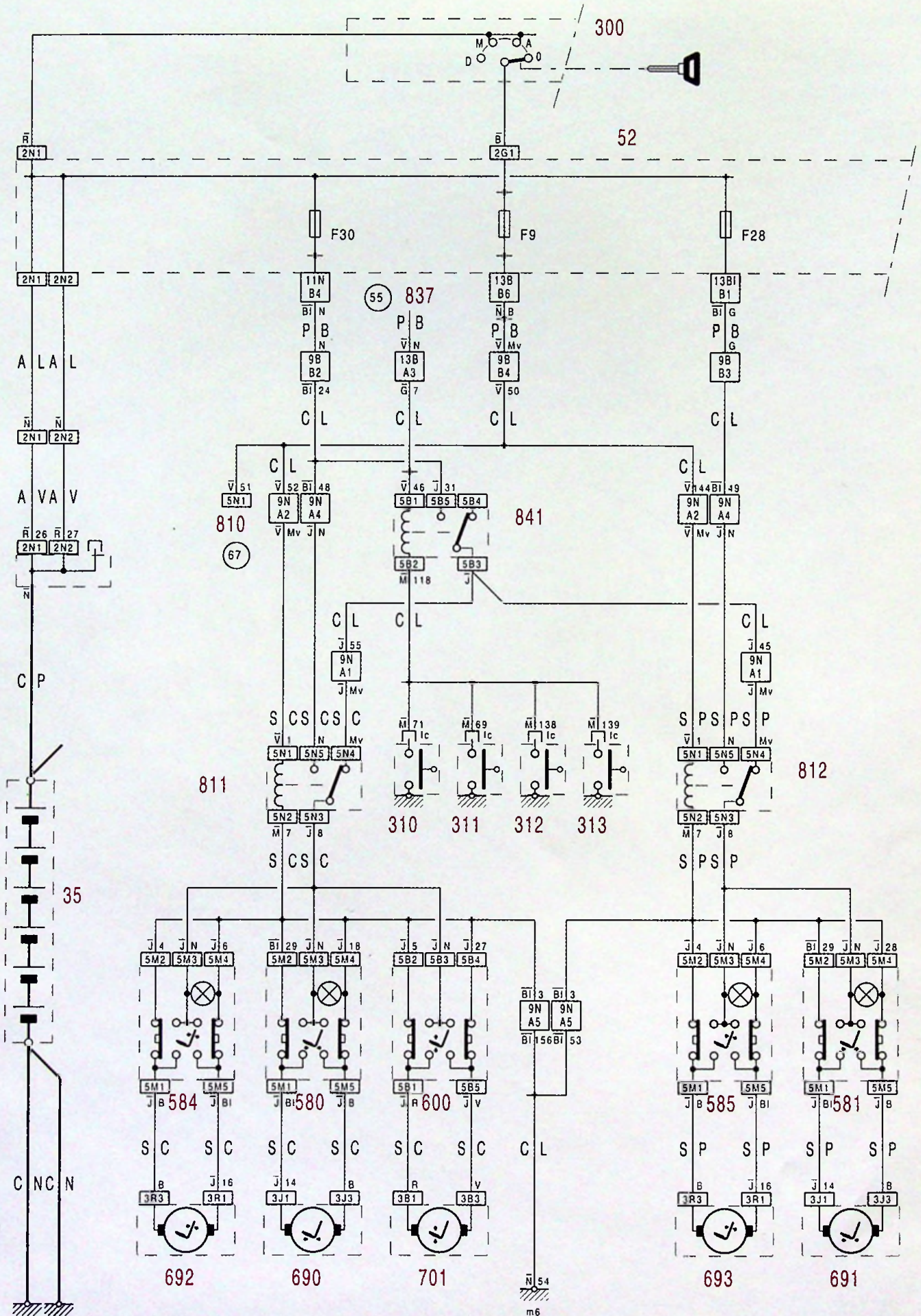

630-1/20a



63

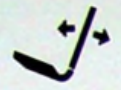

XM
630-1/20b

3

4

XM
630-1/20b



63

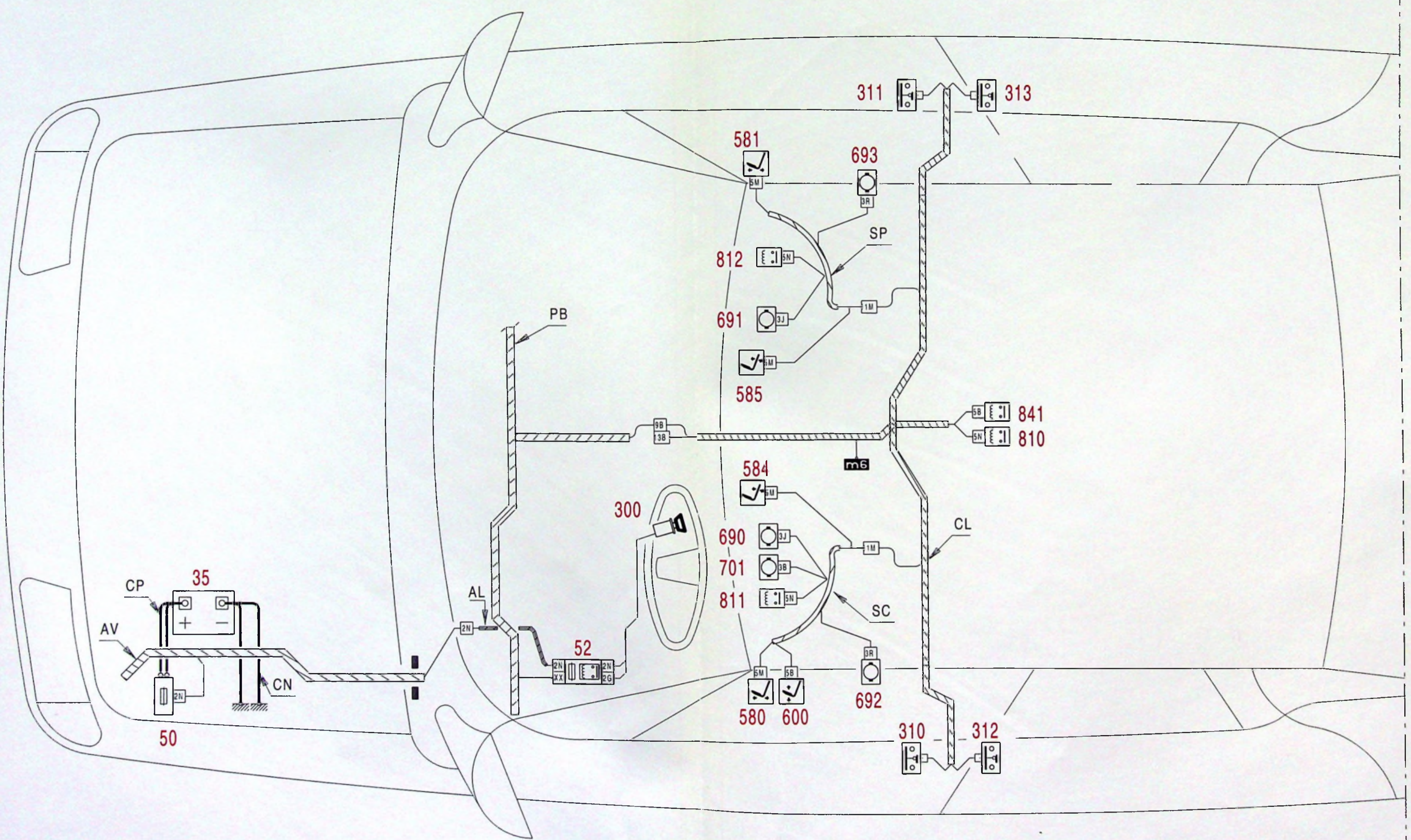

630-1/20b

630-1/20b

1 2 3 4 5 6 7 8 9 10 11 12 13 14 15 16 17 18 19 20 21 22 23 24 25 26 27 28 29 30 31 32 33 34 35 36 37 38 39 40 41 42 43 44 45 46 47 48 49 50 51 52 53 54 55 56 57 58 59 60 61 62



63

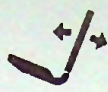

XM
630-1/20b

5

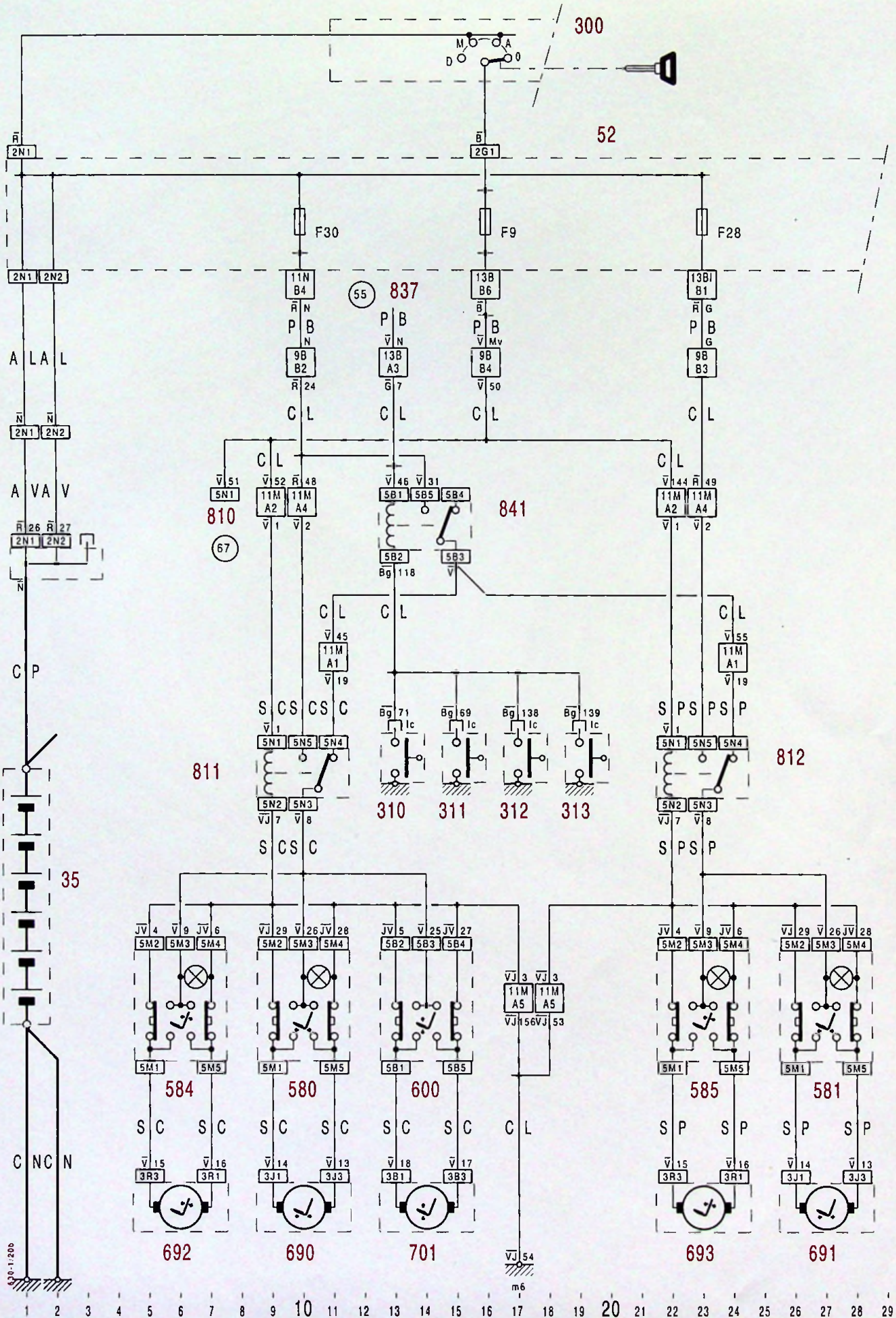



63

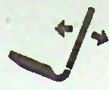

XM
630-1/21

5

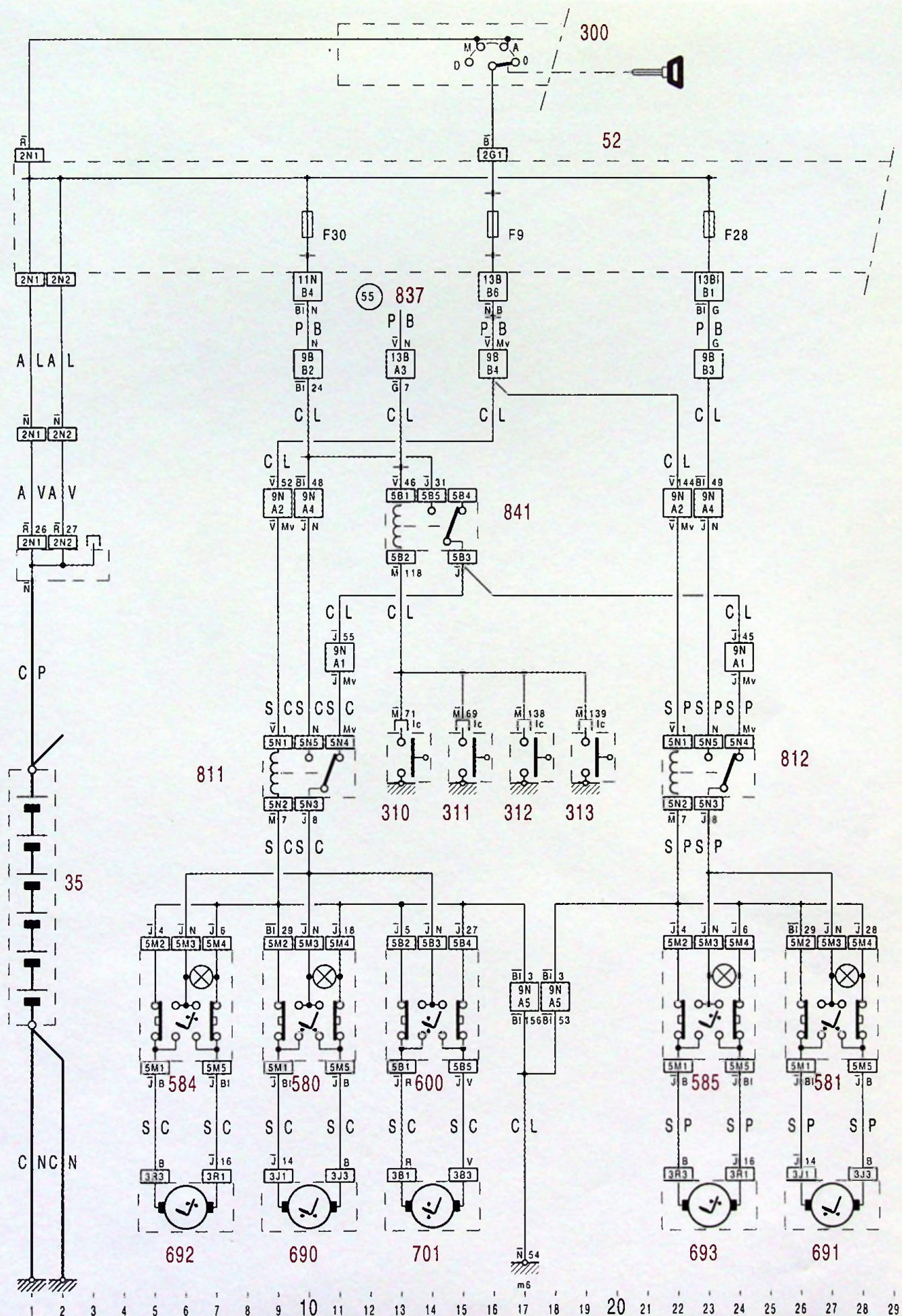

830-1121



63



XM
631-1/20b

6

7

XM
631-1/20b



63

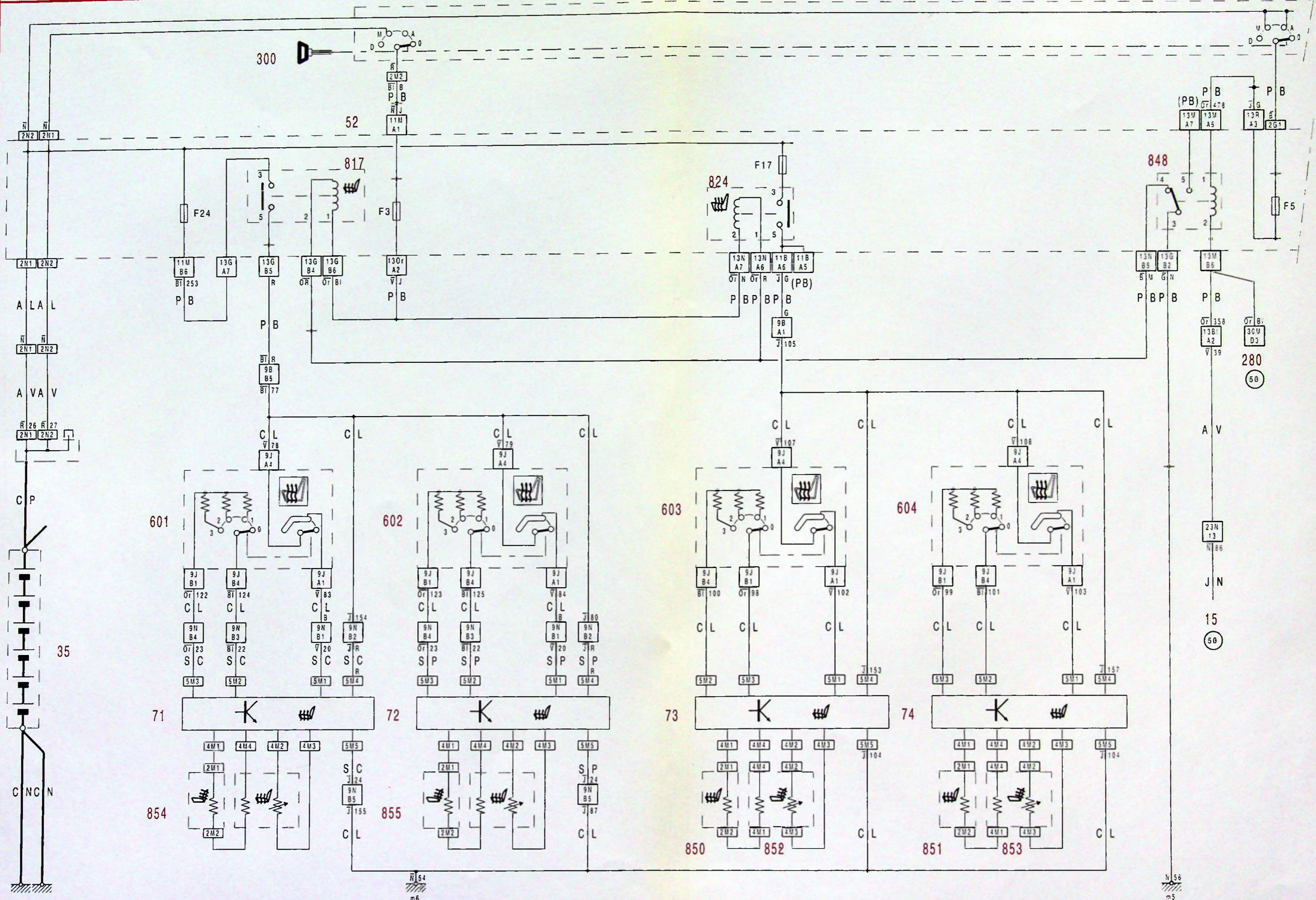

1 2 3 4 5 6 7 8 9 10 11 12 13 14 15 16 17 18 19 20 21 22 23 24 25 26 27 28 29 30 31 32 33 34 35 36 37 38 39 40 41 42 43 44 45 46 47 48 49 50 51 52 53 54 55 56 57 58 59 60 61 62



63



XM
631-1/20c

6

7

XM
631-1/20c



63

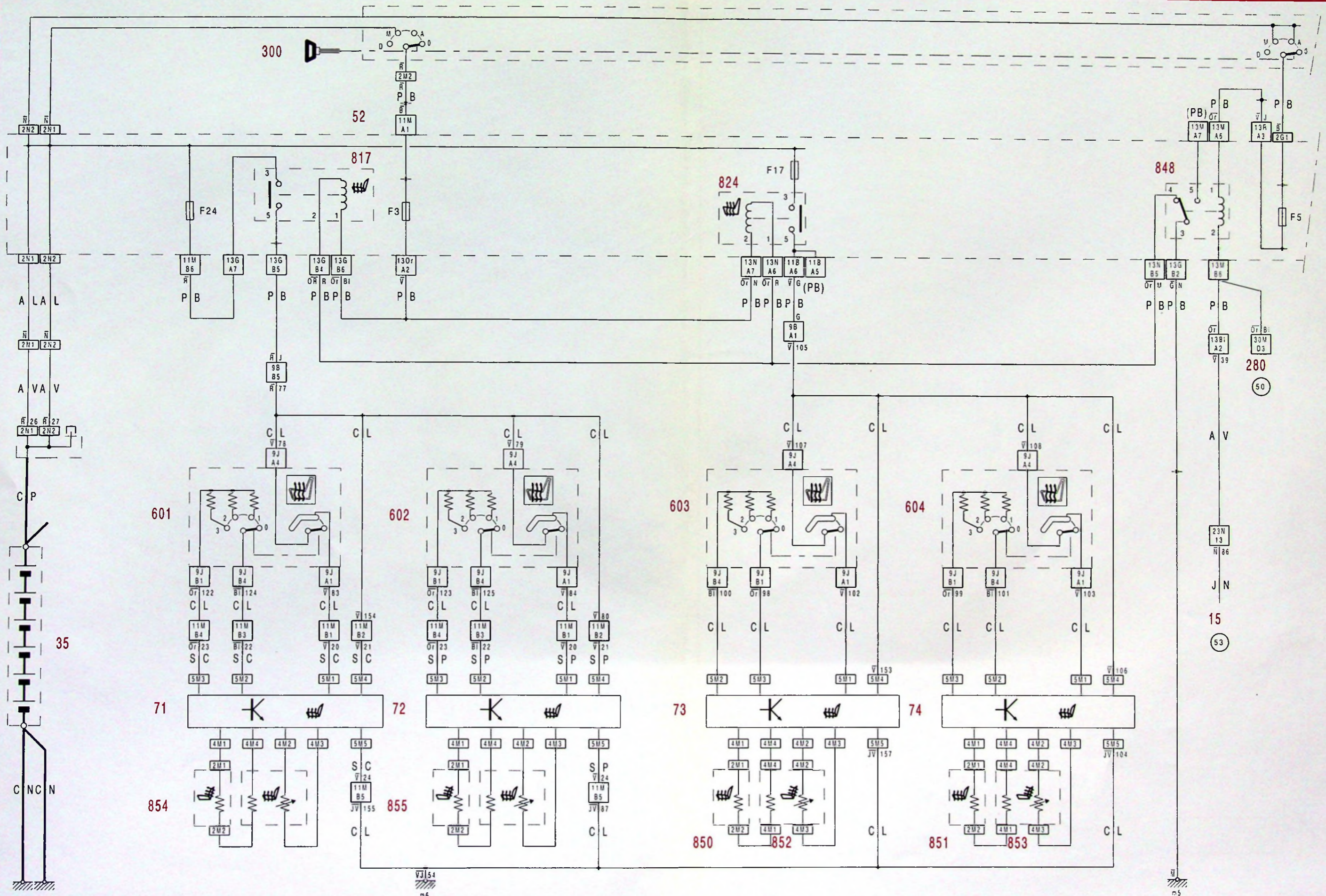

1 2 3 4 5 6 7 8 9 10 11 12 13 14 15 16 17 18 19 20 21 22 23 24 25 26 27 28 29 30 31 32 33 34 35 36 37 38 39 40 41 42 43 44 45 46 47 48 49 50 51 52 53 54 55 56 57 58 59 60 61 62



63



XM
632-1/20

5

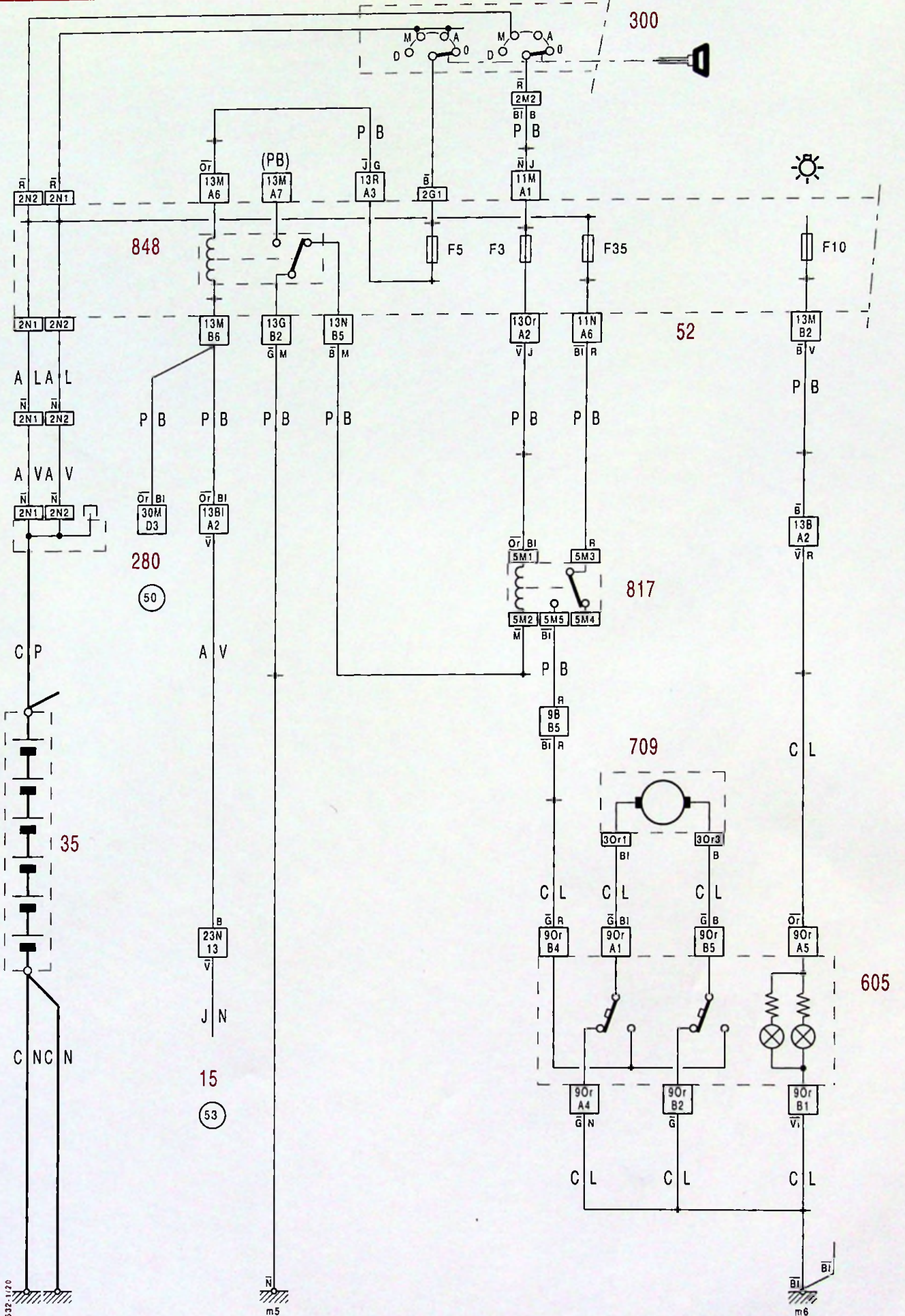

632-1/20

632-1/20



63



XM
632-1/20a

5

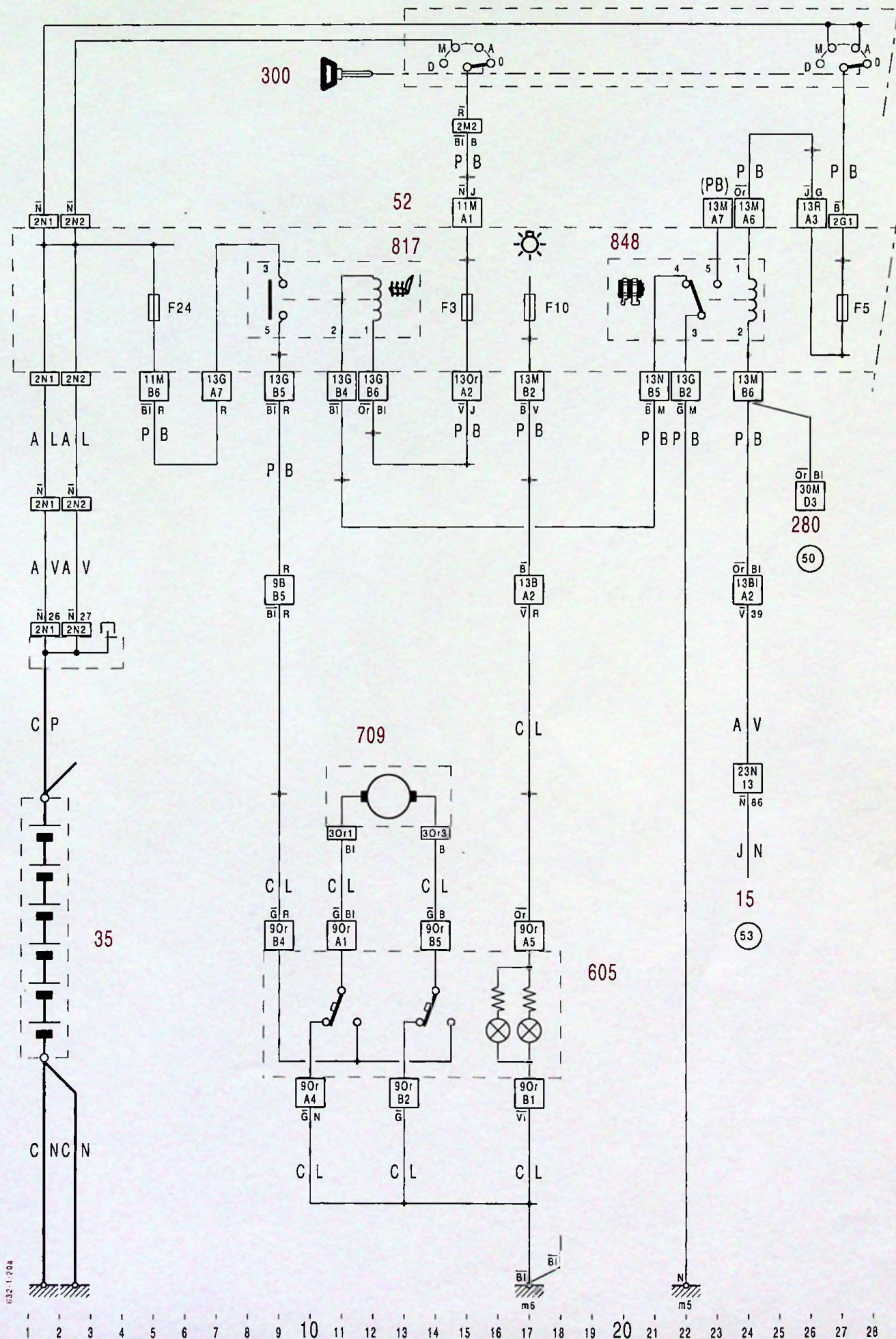

632-1/20a

632-1/20a



63



XM
632-1/20b

5

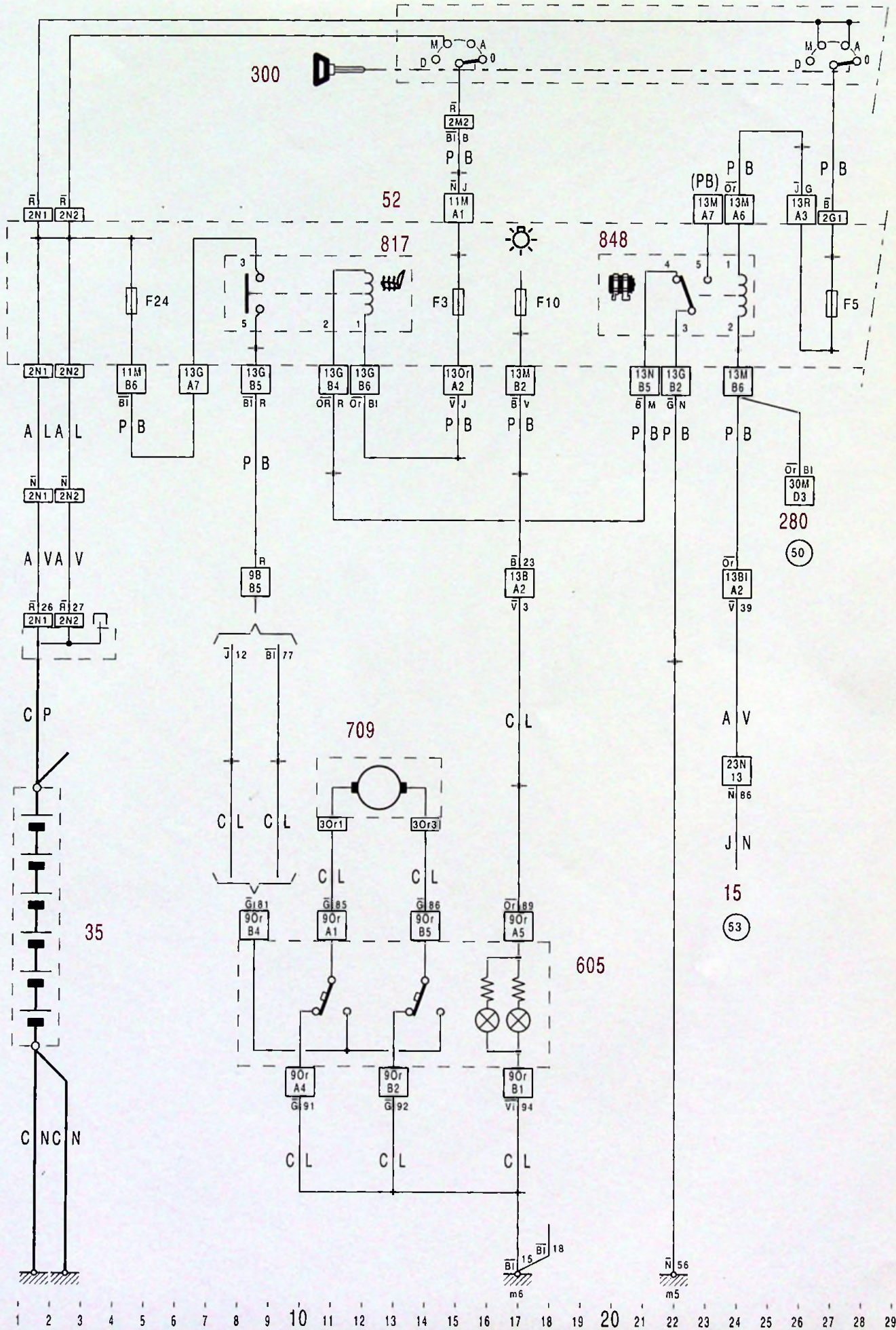



63



XM
632-1/20c

3

4

XM
632-1/20c



63

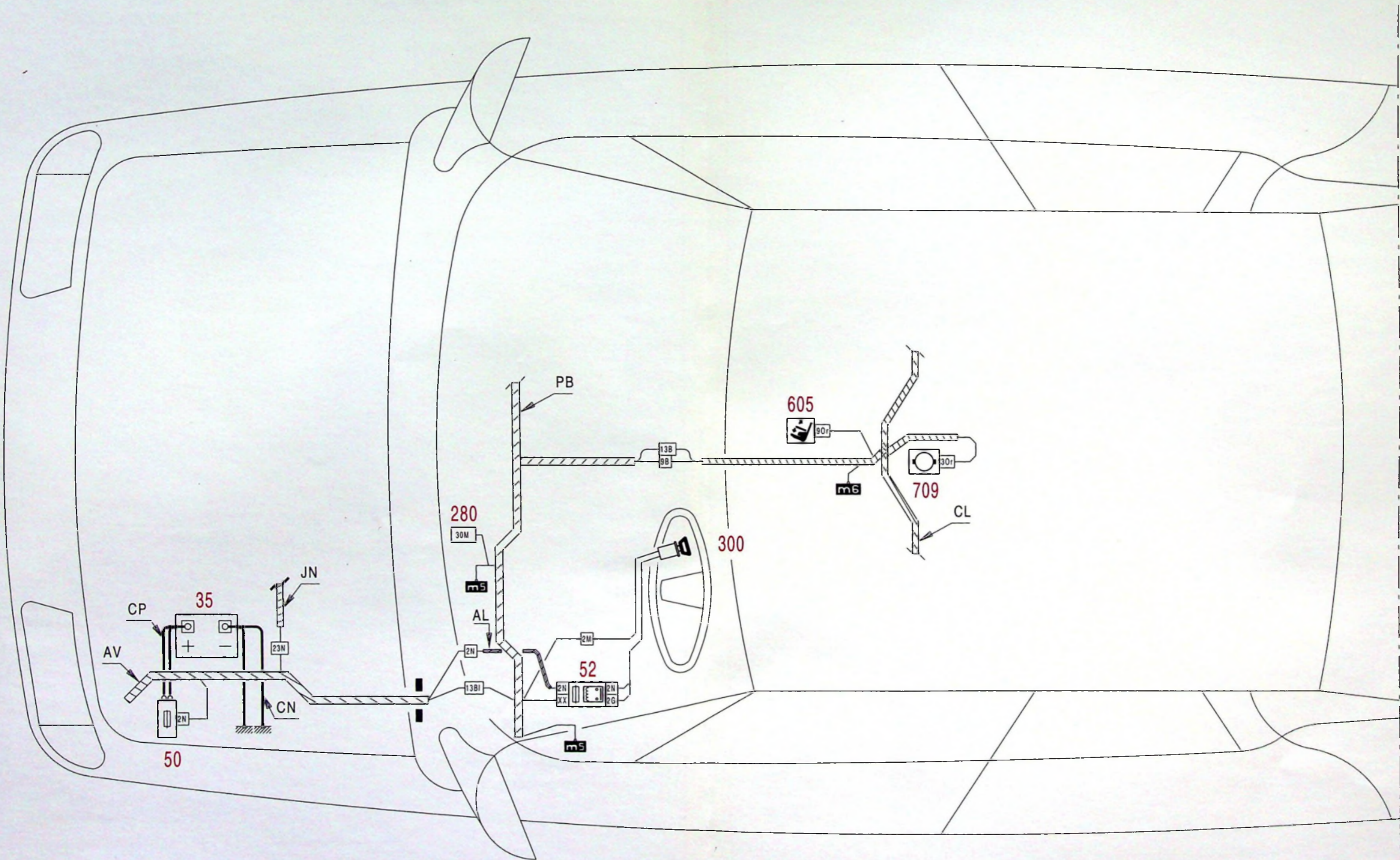



63



XM
632-1/20c

5

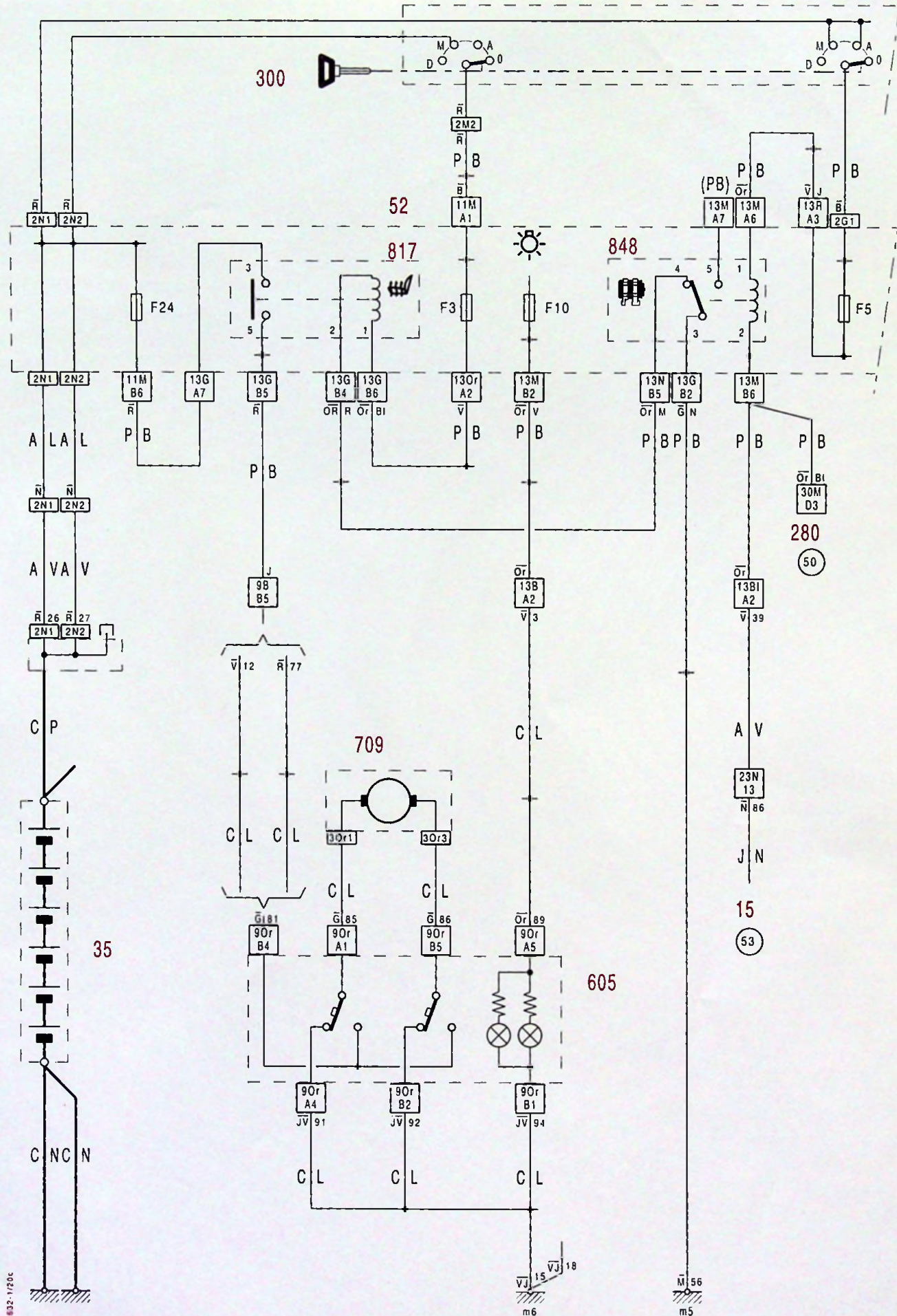

632-1/20c

632-1-20c



63



XM
632-1/20d

5

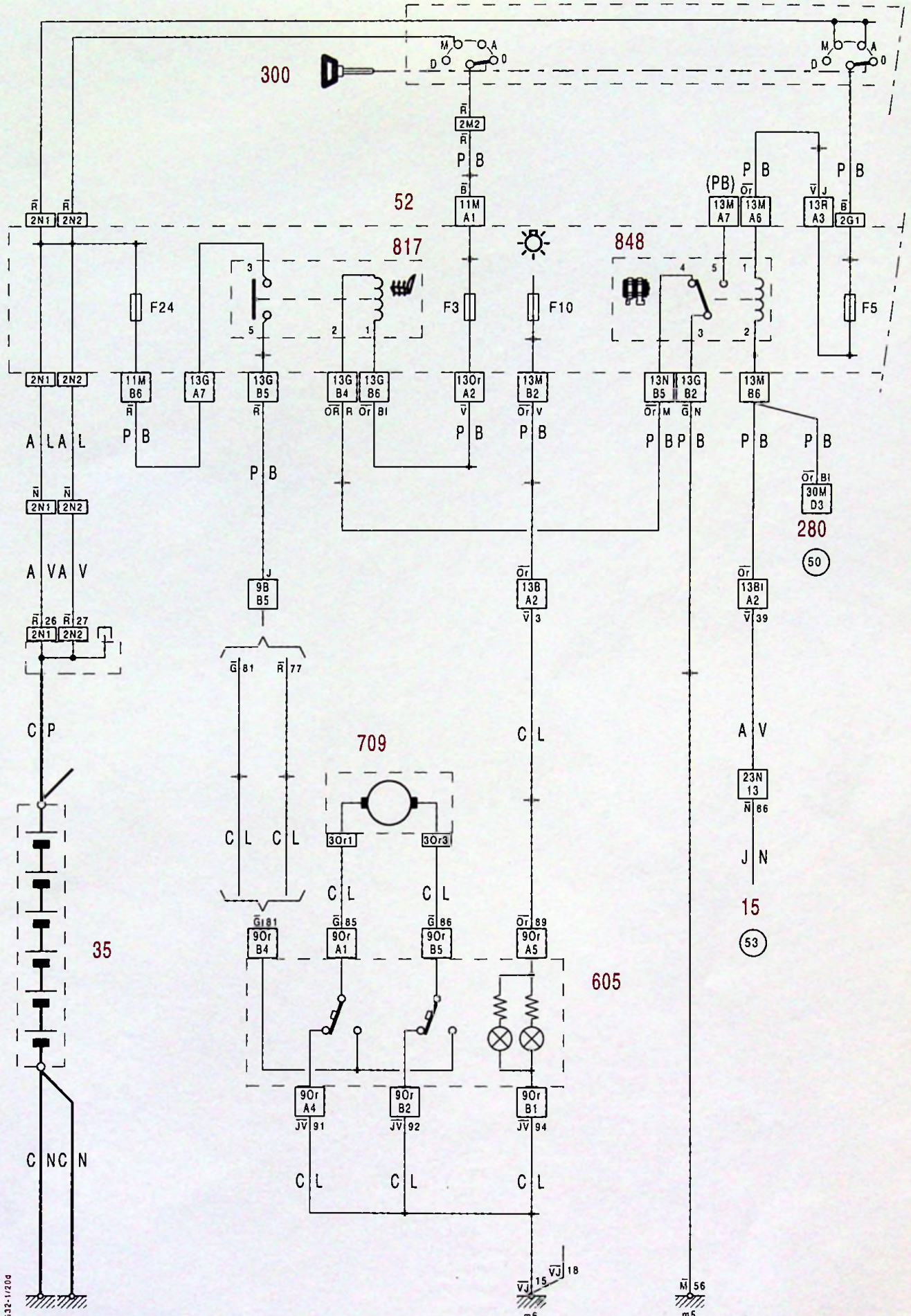

632-1/20d

632-1/20d