

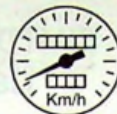

52



XM  
520-000/1

1

# FONCTION : TABLEAU DE BORD

NOMENCLATURE DES PIECES  
LISTE DES SCHEMAS





52

## NOMENCLATURE DES PIECES

XM  
520-000/1

3

Rep.	Désignation	Fonct.	Rep.	Désignation	Fonct.
1	Afficheur central voyants	52			
2	Afficheur droit (ordinateur, montre, temp. ext.)	52			
3	Afficheur gauche (afficheur électronique ou silhouette)	52			
35	Batterie	TT			
40	Bloc compteurs	52			
50	Boîtier d'alimentation	TT			
51	Boîtier de dérivation	TT			
52	Boîtier interconnexions	TT			
53	Boîtier de température d'eau	52-64			
59	Boîtier de préchauffage	51-58			
61	Boîtier catalyseur	51			
65	Boîtier de niveau d'eau	52			
133	Bruiteur niveau et/ou pression hydraulique	52			
142	Calculateur injection	51			
143	Calculateur suspension	51-58			
154	Capteur distance	51-58			
212	Commutateur droit (essuie-vitre avant, ordinateur)	56			
280	Connecteur diagnostic	TT			
294	Contacteur de ceinture de sécurité conducteur	52			
300	Contacteur antivol	TT			
315	Contact frein à main	52			
316	Contact niveau d'eau de refroidissement	52			
317	Contact niveau hydraulique	52			
319	Contact stop	54			
650	Jauge carburant	52			
671	Monocontact huile moteur	52			
672	Mano-contact hydraulique	52			
750	Plaquettes de frein avant gauche	52			
751	Plaquettes de frein avant droit	52			
765	Poste radio	65			
807	Relais injection	51-52			
880	Rhéostat d'éclairage	52-65			
902	Sonde niveau d'huile moteur	52			
904	Sonde pression d'huile moteur	51-52			
906	Sonde température d'air extérieur	52			
910	Sonde température d'eau moteur	52-64			
911	Sonde température d'eau moteur (cadran)	52			
917	Sonde température catalyseur	51			
918	Sonde température d'huile moteur	52			

4

XM  
520-000/1CHAPITRE TABLEAU DE BORD  
LISTE DES SCHEMAS

52



## BLOC COMPTEURS

NUMERO	DIRECTION	VALIDITE	DESIGNATION
520-0/10	Tous Types	6383 → → 6749	Schéma de principe XMA42
520-0/10a	Tous Types	6749 → → 7329	Evolution a : Suppression du voyant lanternes Ajout du voyant Airbag XMS151
520-0/10b	Tous Types	7329 → → 7483	Evolution b : Ajout du voyant Airbag latéral XMC014
520-0/10c	Tous Types	7483 →	Evolution c : Voyant Airbag + APC ald masse XMC025
520-0/20	Tous Types	6383 → → 6749	Bloc compteurs XMA45
520-0/20a	Tous Types	6749 → → 6947	Evolution a : Suppression du voyant lanternes Evolution boîte fusibles XMS152
520-0/20b	Tous Types	6947 → → 7084	Evolution b : Ajout du voyant Airbag XMC001
520-0/20c	Tous Types	7084 → → 7329	Evolution c : Evolution faisceaux PB et AV XMC006
520-0/20d	Tous Types	7329 → → 7483	Evolution d : Evolution faisceaux PB, MT et JN XMC015
520-0/20e	Tous Types	7483 →	Evolution e : Evolution bloc compteurs XMC026
520-0/21	Tous Types	6383 → → 6749	Indicateurs niveau et température huile XMA46
520-0/21a	Tous Types	6749 → → 7084	Evolution a : Suppression du voyant lanternes Evolution boîte fusibles XMS153
520-0/21b	Tous Types	7084 → → 7329	Evolution b : Evolution faisceaux JN, MT et PB XMC007
520-0/21c	Tous Types	7329 → → 7483	Evolution c : Evolution faisceaux PB, MT et JN XMC016
520-0/21d	Tous Types	7483 →	Evolution d : Evolution faisceaux JN et MT XMC027





52

XM  
520-000/1

5

## AFFICHEUR CENTRAL

NUMERO	DIRECTION	VALIDITE	DESIGNATION
521-0/10	Tous Types	6383 → → 6568	<b>VEHICULE SANS AFFICHEUR GAUCHE</b> Schéma de principe XMA43
521-0/10a	Tous Types	6568 → → 6749	Evolution a : Evolution afficheur central XMS122
521-0/10b	Tous Types	6749 → → 7483	Evolution b : Evolution afficheur central XMS154
521-1/11	Gauche	6383 → → 6568	<b>VEHICULE SANS AFFICHEUR GAUCHE</b> Afficheur central XMA49
521-1/11a	Gauche	6568 → → 6749	Evolution a : Evolution afficheur central XMS123
521-1/11b	Gauche	6749 → → 6947	Evolution b : Evolution afficheur central Evolution boîte fusibles XMS155
521-1/11c	Gauche	6947 → → 7084	Evolution c : Suppression du faisceau UD XMC002
521-1/11d	Gauche	7084 → → 7329	Evolution d : Evolution faisceaux JN, MT, AV et PB XMC008
521-1/11e	Gauche	7329 → → 7483	Evolution e : Evolution faisceaux PB, MT et JN XMC017
521-2/11	Droite	6383 → → 6568	<b>VEHICULE SANS AFFICHEUR GAUCHE</b> Afficheur central XMA50
521-2/11a	Droite	6568 → → 6749	Evolution a : Evolution afficheur central XMS124
521-2/11b	Droite	6749 → → 6947	Evolution b : Evolution afficheur central Evolution boîte fusibles XMS156
521-2/11c	Droite	6947 → → 7084	Evolution c : Suppression du faisceau UD XMC003
521-2/11d	Droite	7084 → → 7329	Evolution d : Evolution faisceaux JN, MT, AV et PB XMC009
521-2/11e	Droite	7329 → → 7483	Evolution e : Evolution faisceaux PB, MT et JN XMC018
522-0/10	Tous Types	6383 → → 6568	<b>VEHICULE AVEC AFFICHEUR GAUCHE</b> Schéma de principe XMA44
522-0/10a	Tous Types	6568 → → 6749	Evolution a : Evolution afficheur central XMS125
522-0/10b	Tous Types	6749 →	Evolution b : Evolution afficheur central Evolution boîte fusibles XMS157





## AFFICHEUR CENTRAL (suite)

NUMERO	DIRECTION	VALIDITE	DESIGNATION
522-1/11	Gauche	6383 → → 6568	<b>VEHICULE AVEC AFFICHEUR GAUCHE</b> Afficheur central XMA47
522-1/11a	Gauche	6568 → → 6749	Evolution a : Evolution afficheur central XMS126
522-1/11b	Gauche	6749 → → 6947	Evolution b : Evolution afficheur central Evolution boîte fusibles XMS158
522-1/11c	Gauche	6947 → → 7084	Evolution c : Suppression du faisceau UD XMC004
522-1/11d	Gauche	7084 → → 7329	Evolution d : Evolution faisceaux JN, MT, AV et PB XMC010
522-1/11e	Gauche	7329 → → 7483	Evolution e : Evolution faisceaux PB, MT et JN XMC019
522-1/11f	Gauche	7483 → → 8028	Evolution f : Evolution faisceaux AV, JN et MT XMC028
522-1/11g	Gauche	8028 →	Evolution g : Evolution du faisceau PB XMC033
522-2/11	Droite	6383 → → 6568	<b>VEHICULE AVEC AFFICHEUR GAUCHE</b> Afficheur central XMA48
522-2/11a	Droite	6568 → → 6749	Evolution a : Evolution afficheur central XMS127
522-2/11b	Droite	6749 → → 6947	Evolution b : Evolution afficheur central Evolution boîte fusibles XMS159
522-2/11c	Droite	6947 → → 7084	Evolution c : Suppression du faisceau UD XMC005
522-2/11d	Droite	7084 → → 7329	Evolution d : Evolution faisceaux JN, MT, AV et PB XMC011
522-2/11e	Droite	7329 → → 7483	Evolution e : Evolution faisceaux PB, MT et JN XMC020
522-2/11f	Droite	7483 →	Evolution f : Evolution faisceaux PB, AV, JN et MT XMC029





52



XM  
520-000/1

7

### ORDINATEUR DE BORD MONTRE

NUMERO	DIRECTION	VALIDITE	DESIGNATION
523-1/11	Gauche	6383 → → 6749	<b>Ordinateur de bord</b>  XMA51
523-1/11a	Gauche	6749 → → 7329	Evolution a : Evolution boîte fusibles XMS160
523-1/11b	Gauche	7329 → → 7483	Evolution b : Evolution faisceau PB XMC021
523-1/11c	Gauche	7483 →	Evolution c : Evolution faisceaux PB, AV et MT XMC030
523-1/21	Tous Types	6383 → → 6749	<b>Montre</b>  XMS128
523-1/21a	Tous Types	6749 → → 7329	Evolution a : Evolution boîte fusibles XMS162
523-1/21b	Tous Types	7329 → → 7483	Evolution b : Evolution faisceau PB XMC022
523-2/11	Droite	6383 → → 6749	<b>Ordinateur de bord</b>  XMA52
523-2/11a	Droite	6749 → → 7084	Evolution a : Evolution boîte fusibles XMS161
523-2/11b	Droite	7084 → → 7329	Evolution b : Evolution faisceau AV XMC012
523-2/11c	Droite	7329 → → 7483	Evolution c : Evolution faisceau PB XMC023
523-2/11d	Droite	7483 →	Evolution d : Evolution faisceaux PB, AV et MT XMC031





## VOYANT SURCHAUFFE POT CATALYTIQUE

NUMERO	DIRECTION	VALIDITE	DESIGNATION
524-0/11	Tous Types	6383 → → 6749	<b>Voyant surchauffe pot catalytique</b>  XMA53
524-0/11a	Tous Types	6749 → → 7084	Evolution a : Evolution boîte fusibles  XMS163
524-0/11b	Tous Types	7084 → → 7329	Evolution b : Evolution faisceaux PB et AV  XMC013
524-0/11c	Tous Types	7329 → → 7483	Evolution c : Evolution faisceau PB  XMC024
524-0/11d	Tous Types	7483 →	Evolution d : Suppression du Niveau A  XMC032





52

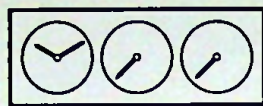

XM  
520-0/10

4

5

XM  
520-0/10

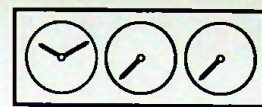

52

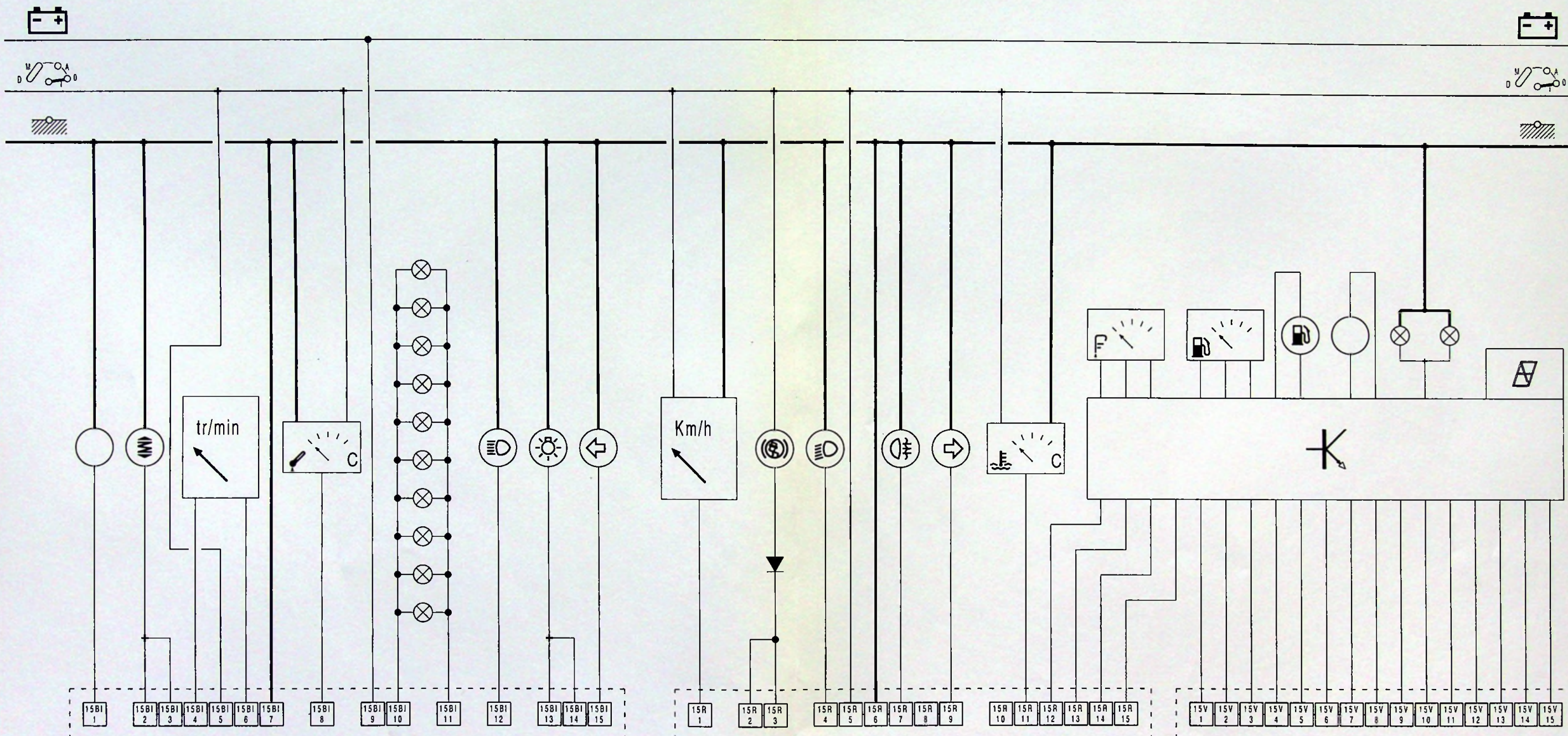

520-0/10

1 2 3 4 5 6 7 8 9 10 11 12 13 14 15 16 17 18 19 20 21 22 23 24 25 26 27 28 29 30 31 32 33 34 35 36 37 38 39 40 41 42 43 44 45 46 47 48 49 50 51 52 53 54 55 56 57 58 59 60 61 62

520-0/10





52

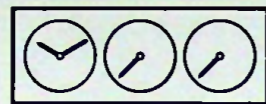

XM  
520-0/10a

5

4

XM  
520-0/10a

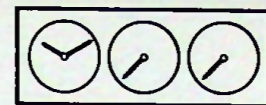

52

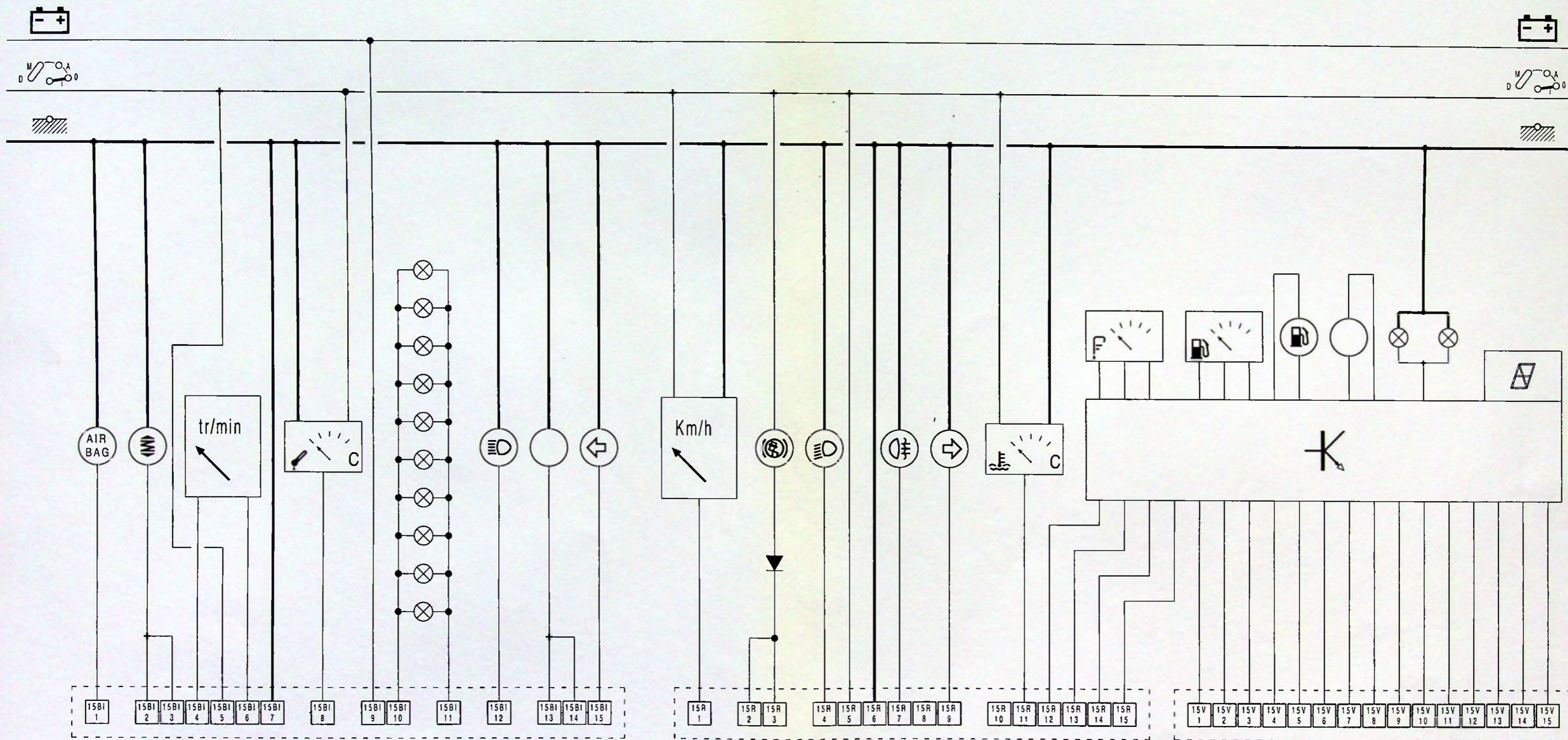

520-0/10a

1 2 3 4 5 6 7 8 9 10 11 12 13 14 15 16 17 18 19 20 21 22 23 24 25 26 27 28 29 30 31 32 33 34 35 36 37 38 39 40 41 42 43 44 45 46 47 48 49 50 51 52 53 54 55 56 57 58 59 60 61 62

520-0/10a





52

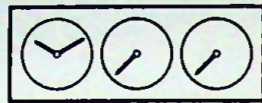

XM  
520-0/10b

4

5

XM  
520-0/10b

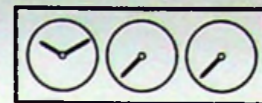

52

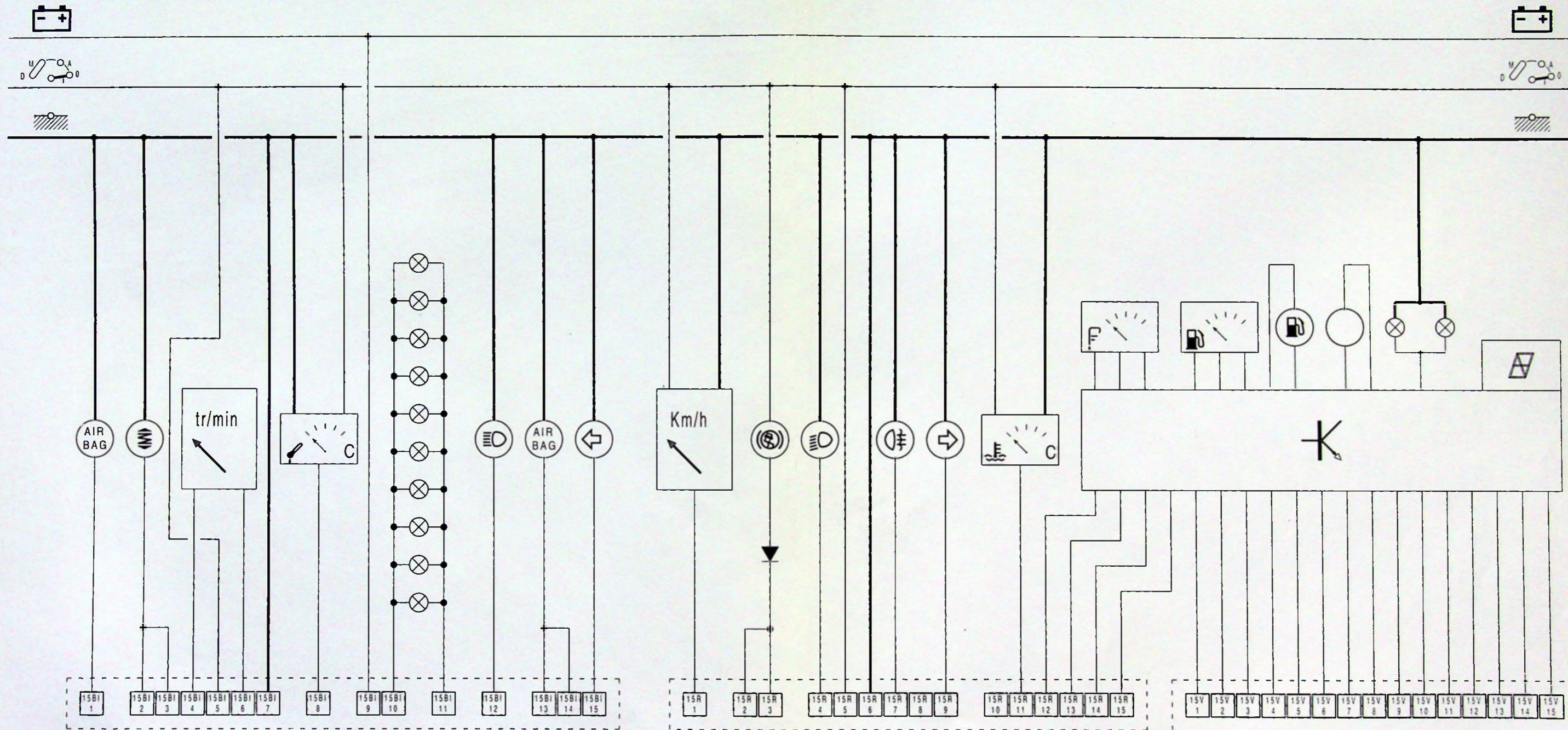

520-0/10b

1 2 3 4 5 6 7 8 9 10 11 12 13 14 15 16 17 18 19 20 21 22 23 24 25 26 27 28 29 30 31 32 33 34 35 36 37 38 39 40 41 42 43 44 45 46 47 48 49 50 51 52 53 54 55 56 57 58 59 60 61 62

520-0/10b





52

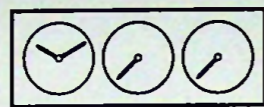

XM  
520-0/10c

4

5

XM  
520-0/10c

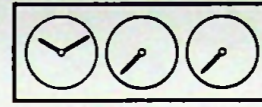

52

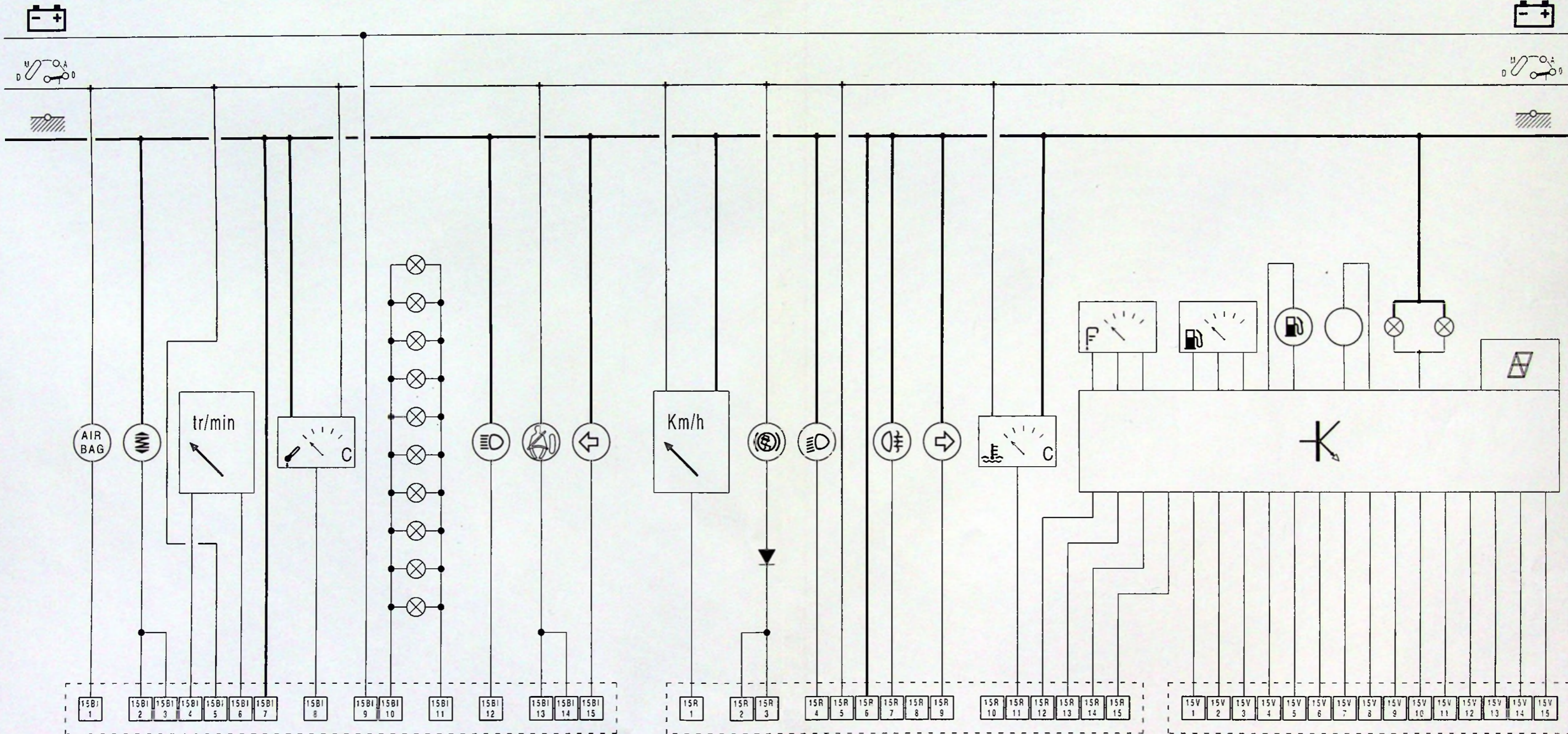





52

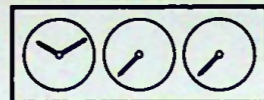

XM  
520-0/20

6

7

XM  
520-0/20

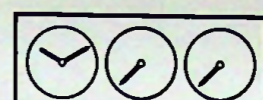

52

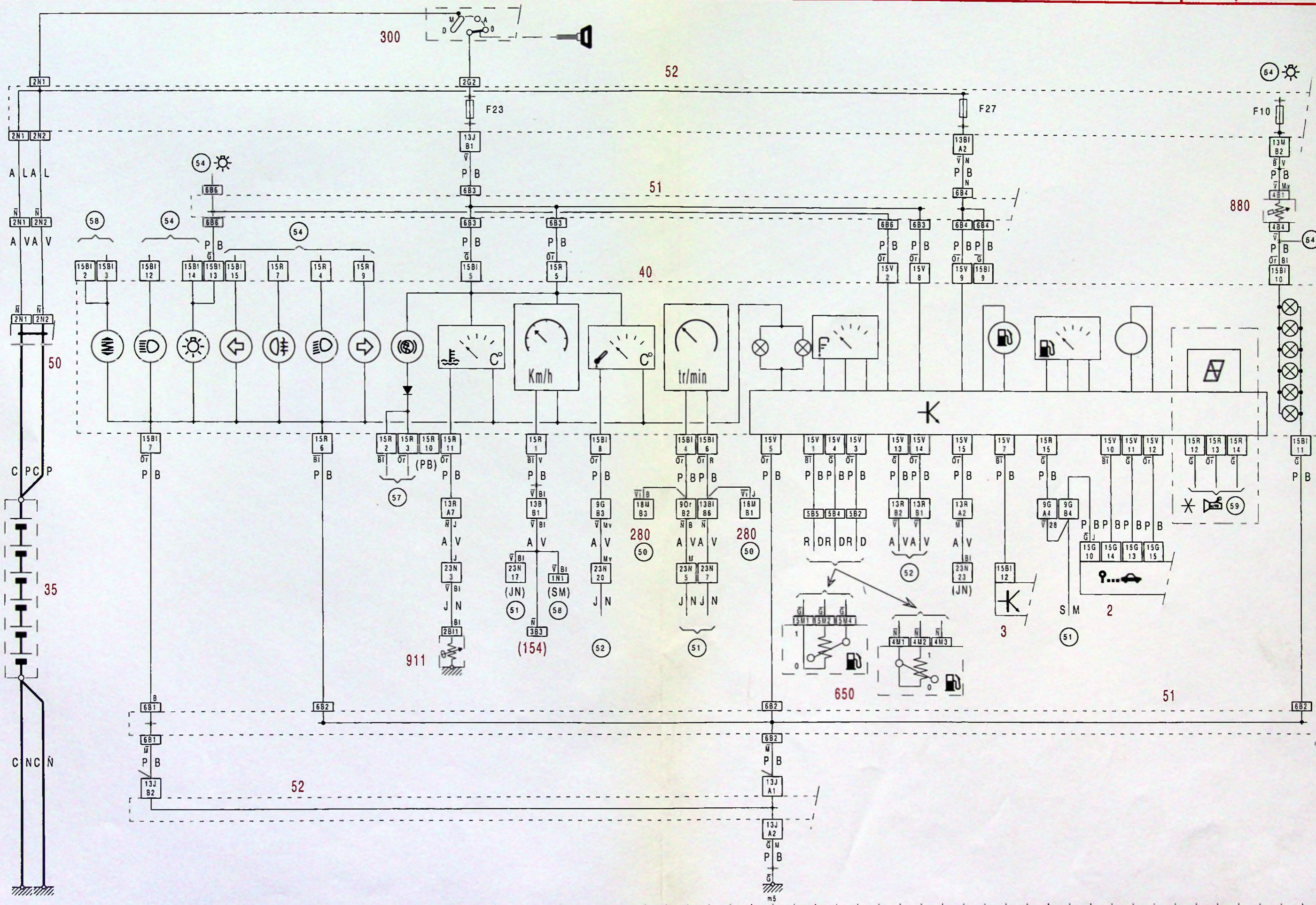





52



XM  
520-0/20a

6

7

XM  
520-0/20a

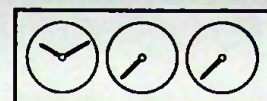

52

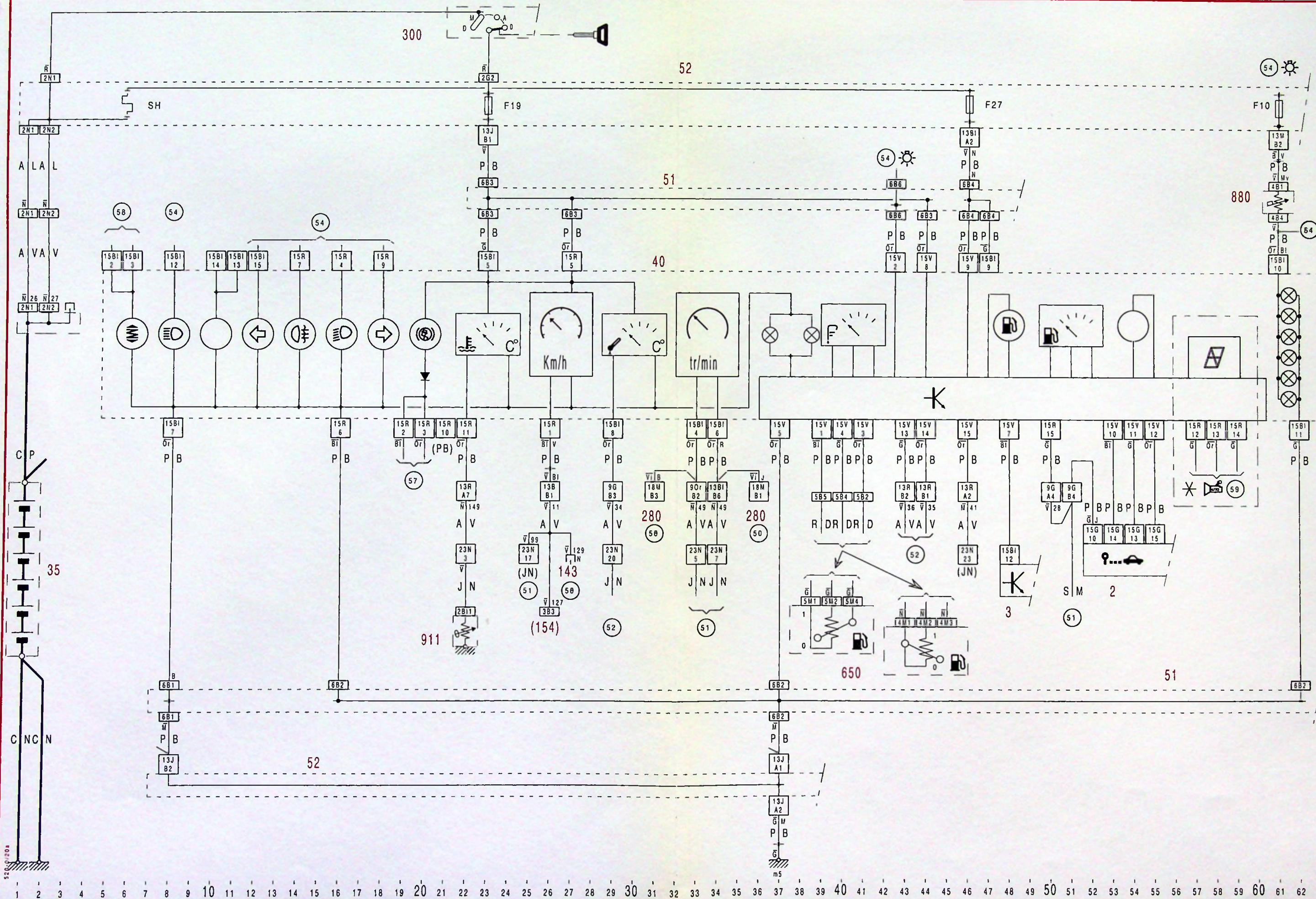

520-0/20a

520-0/20a

1 2 3 4 5 6 7 8 9 10 11 12 13 14 15 16 17 18 19 20 21 22 23 24 25 26 27 28 29 30 31 32 33 34 35 36 37 38 39 40 41 42 43 44 45 46 47 48 49 50 51 52 53 54 55 56 57 58 59 60 61 62





52

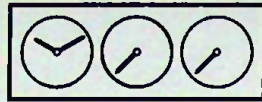

XM  
520-0/20b

6

7

XM  
520-0/20b

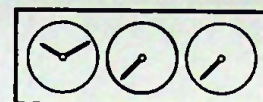

52

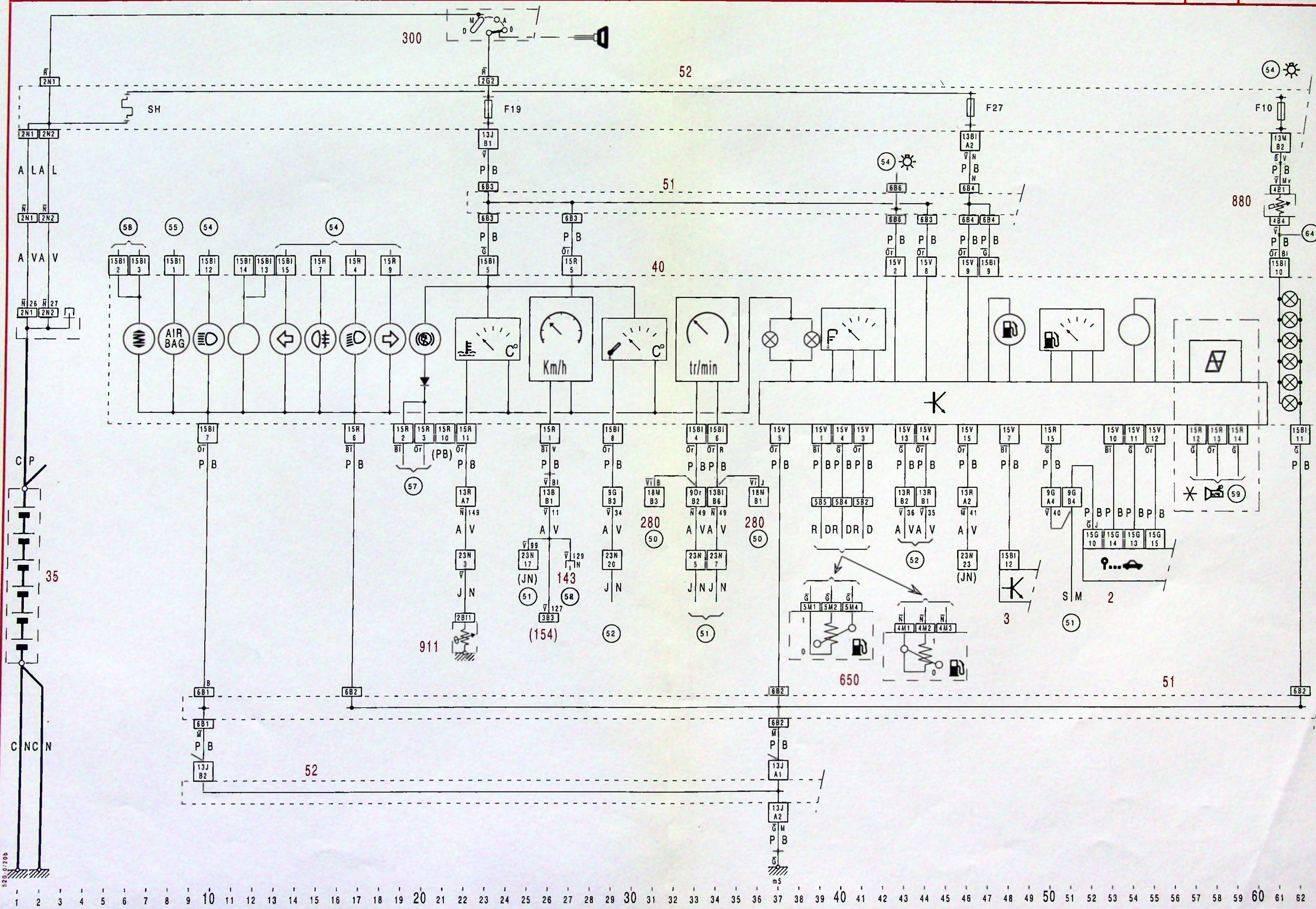

520-0/20b

520-0/20b





52

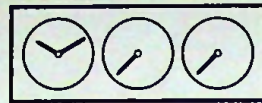

XM  
520-0/20c

6

7

XM  
520-0/20c

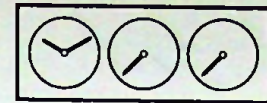

52

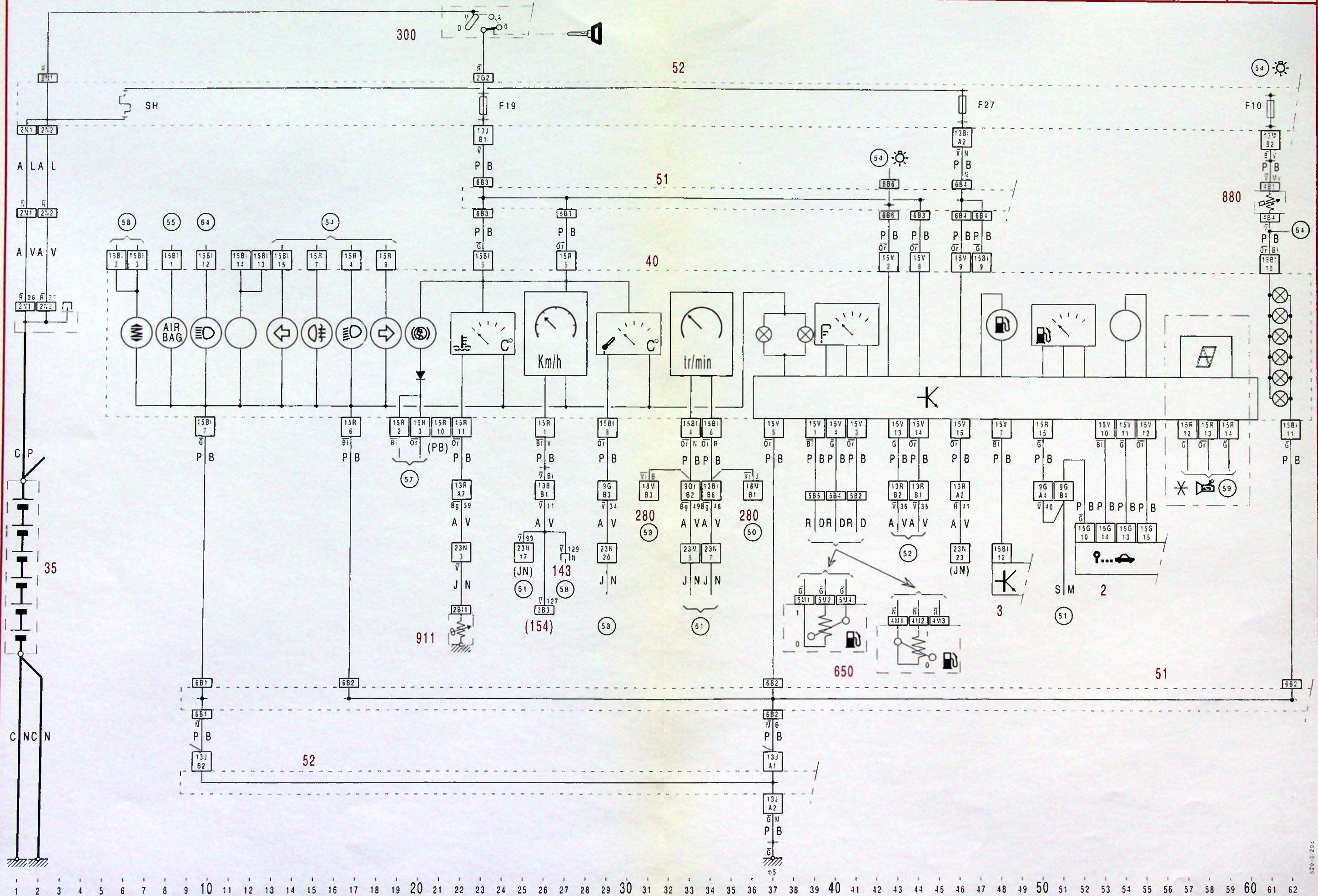

1 2 3 4 5 6 7 8 9 10 11 12 13 14 15 16 17 18 19 20 21 22 23 24 25 26 27 28 29 30 31 32 33 34 35 36 37 38 39 40 41 42 43 44 45 46 47 48 49 50 51 52 53 54 55 56 57 58 59 60 61 62





52



XM  
520-0/20d

6

7

XM  
520-0/20d

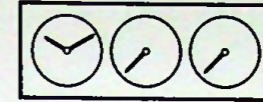

52

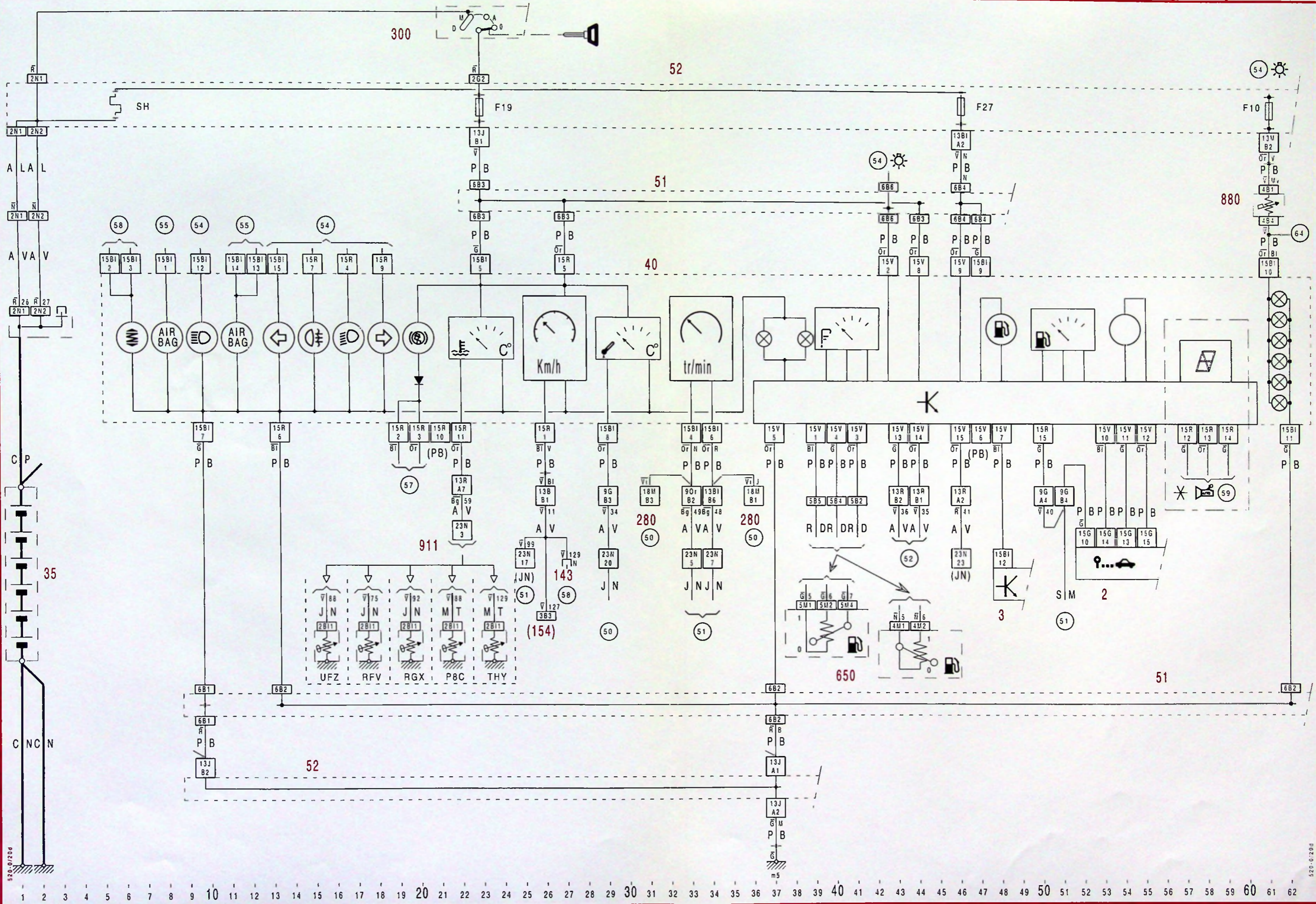





52



XM  
520-0/20e

3

4

XM  
520-0/20e



52

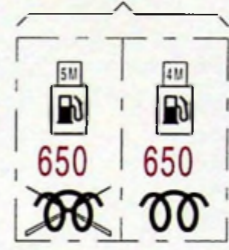
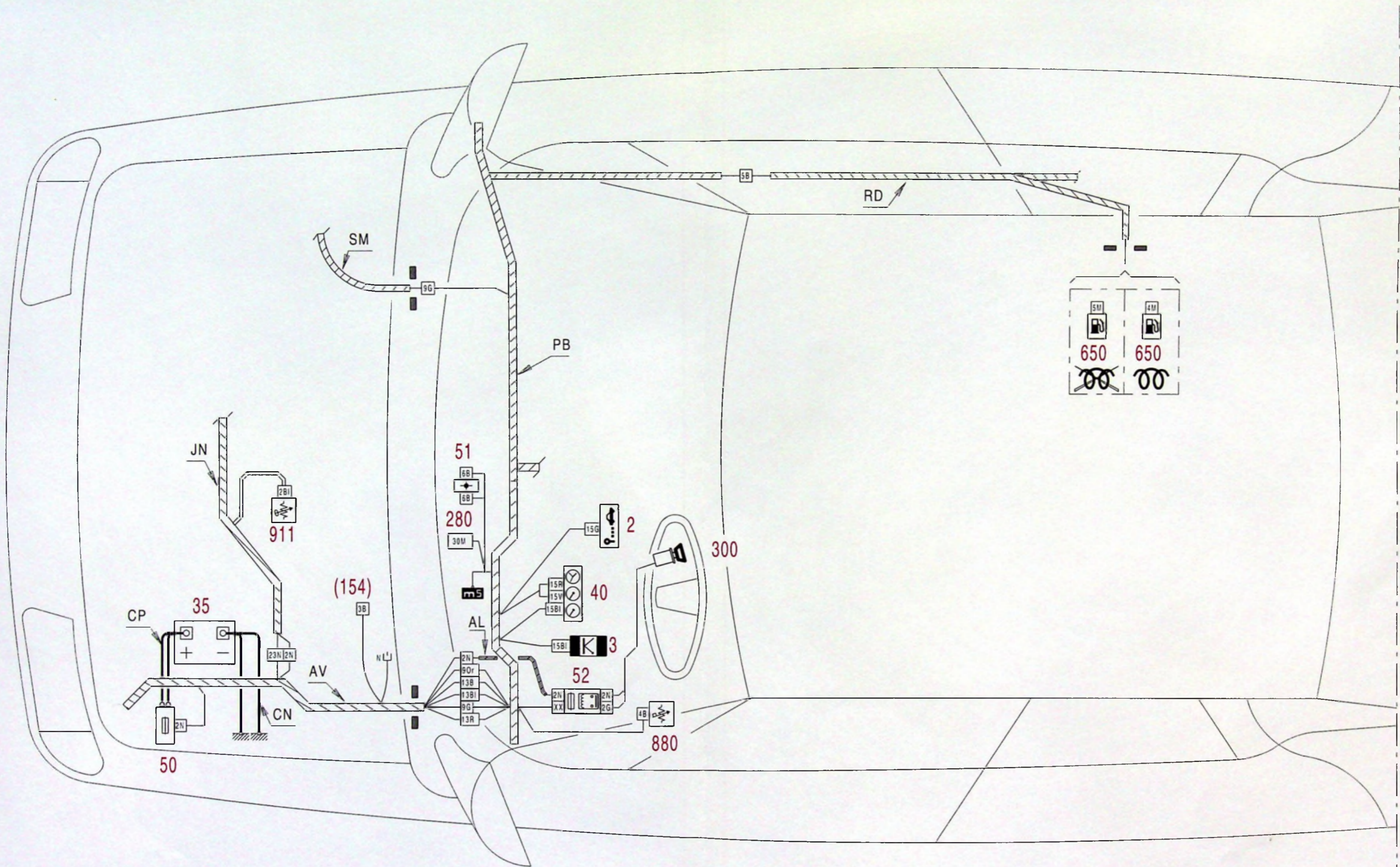

520-0/20e

520-0/20e









52

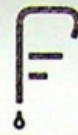

XM  
520-0/21

3

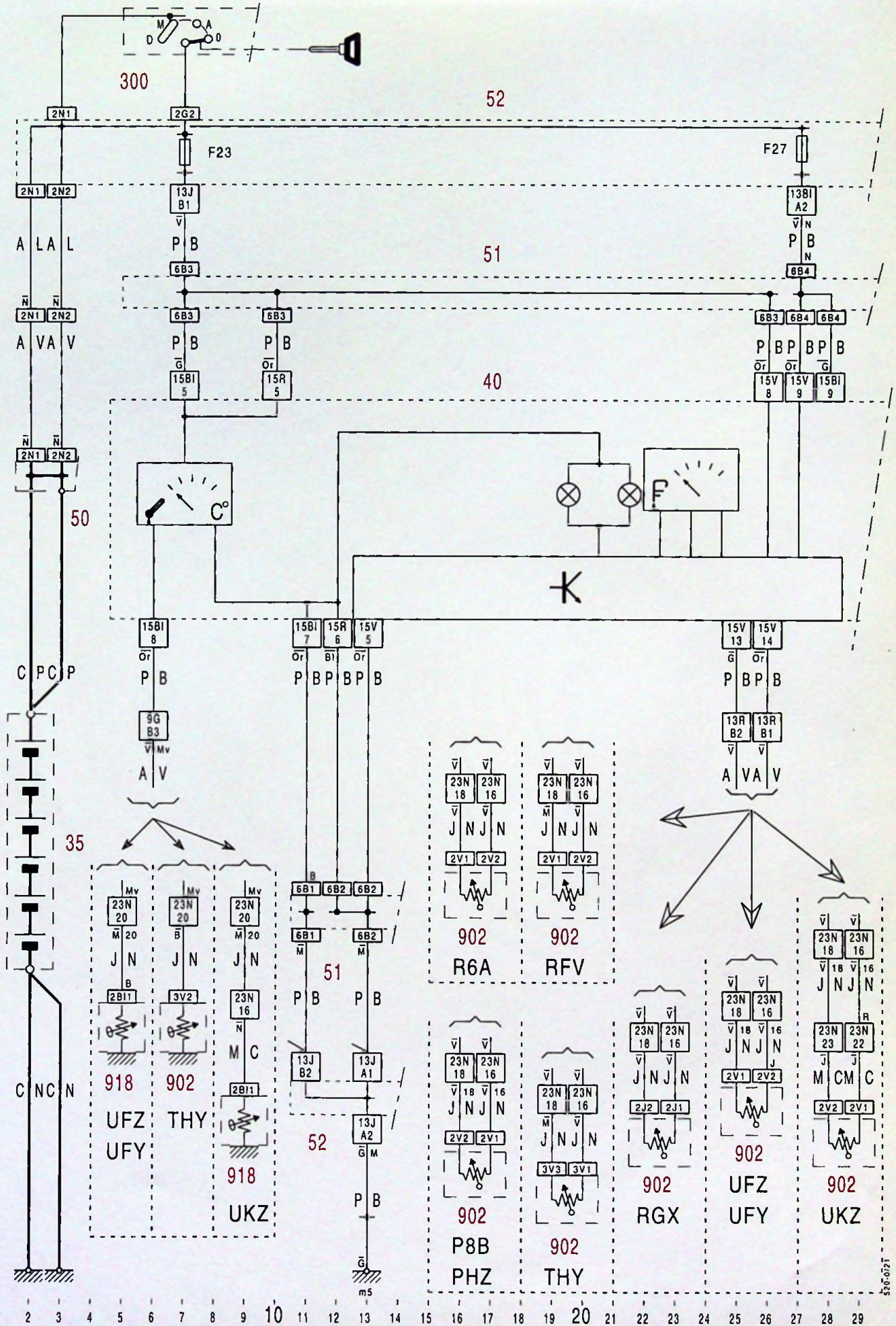

520-0/21

520-0/21













52



XM  
520-0/21c

3

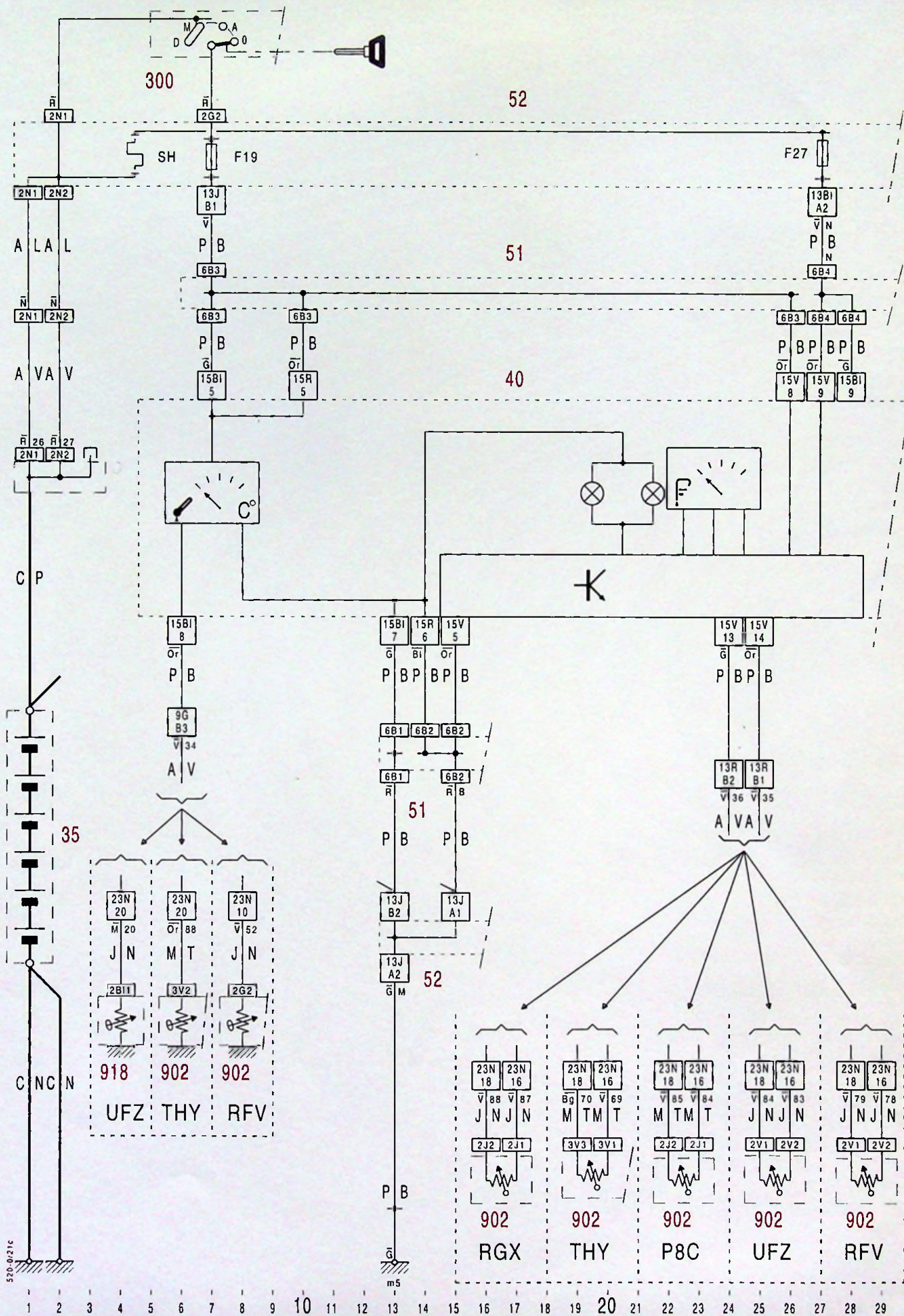



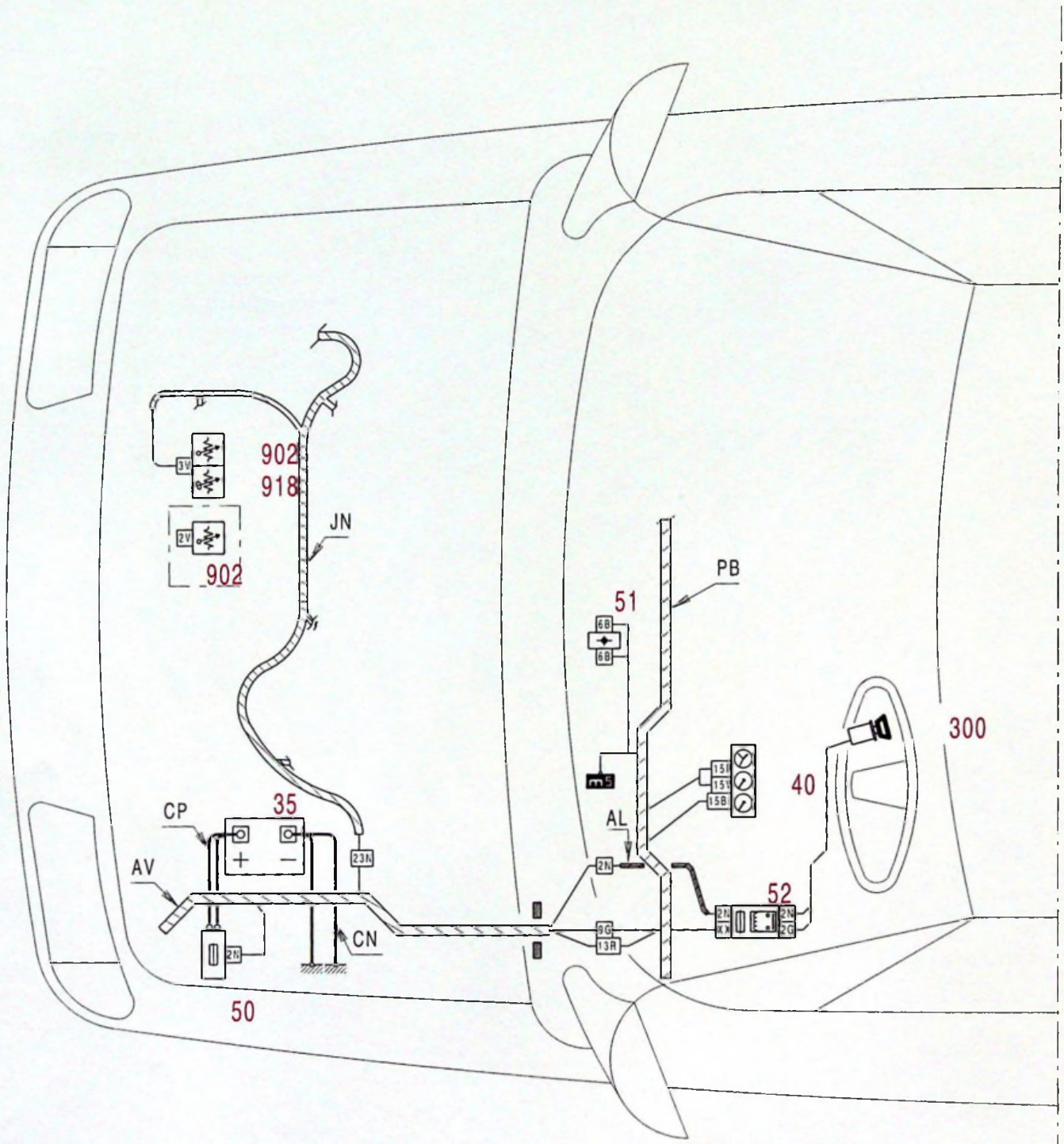
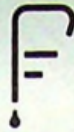





52

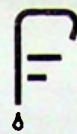

XM  
520-0/21d

3

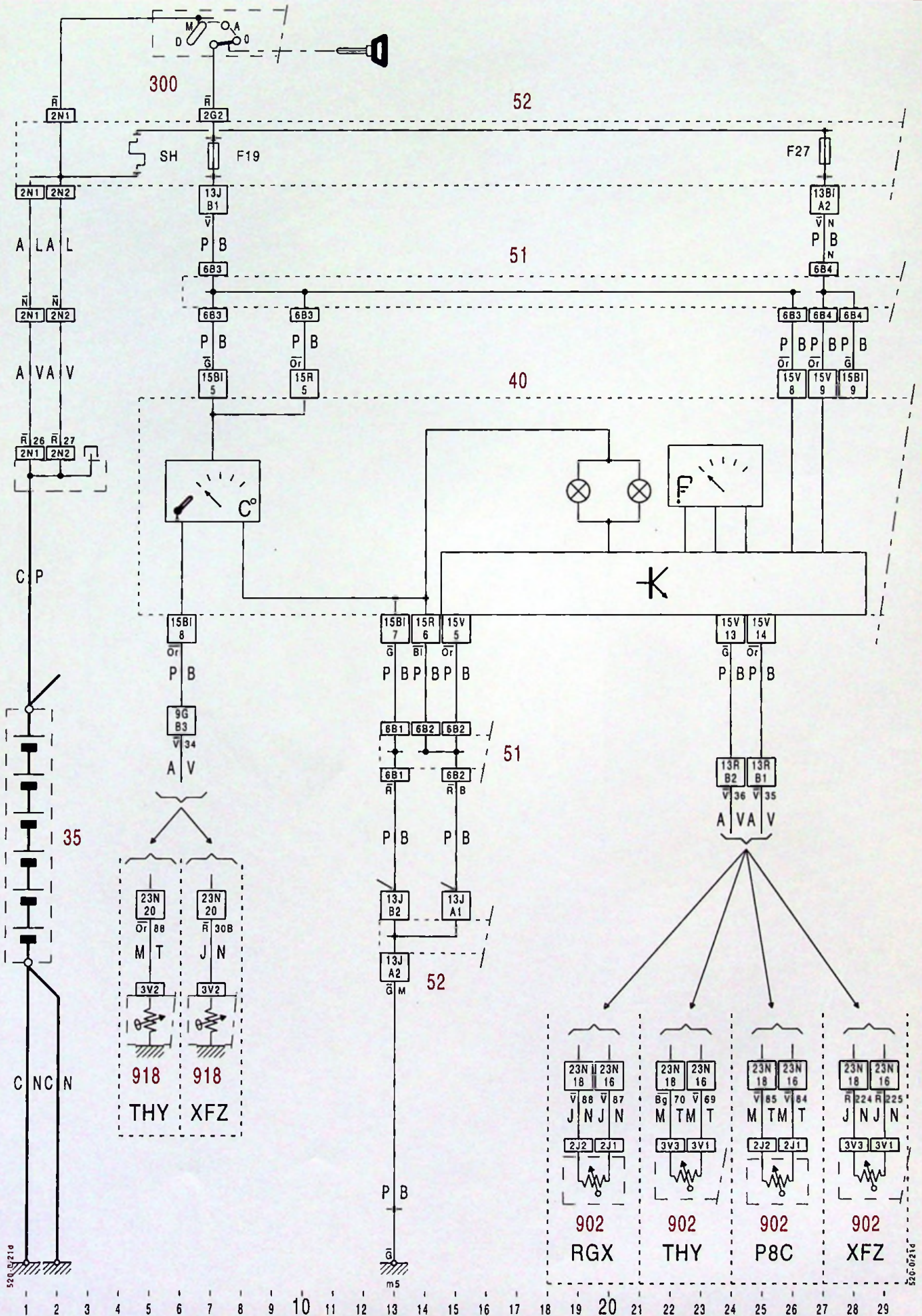





52

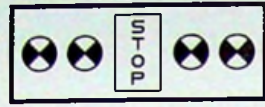

XM  
521-0/10

4

5

XM  
521-0/10

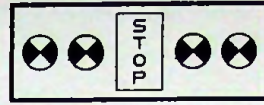

52

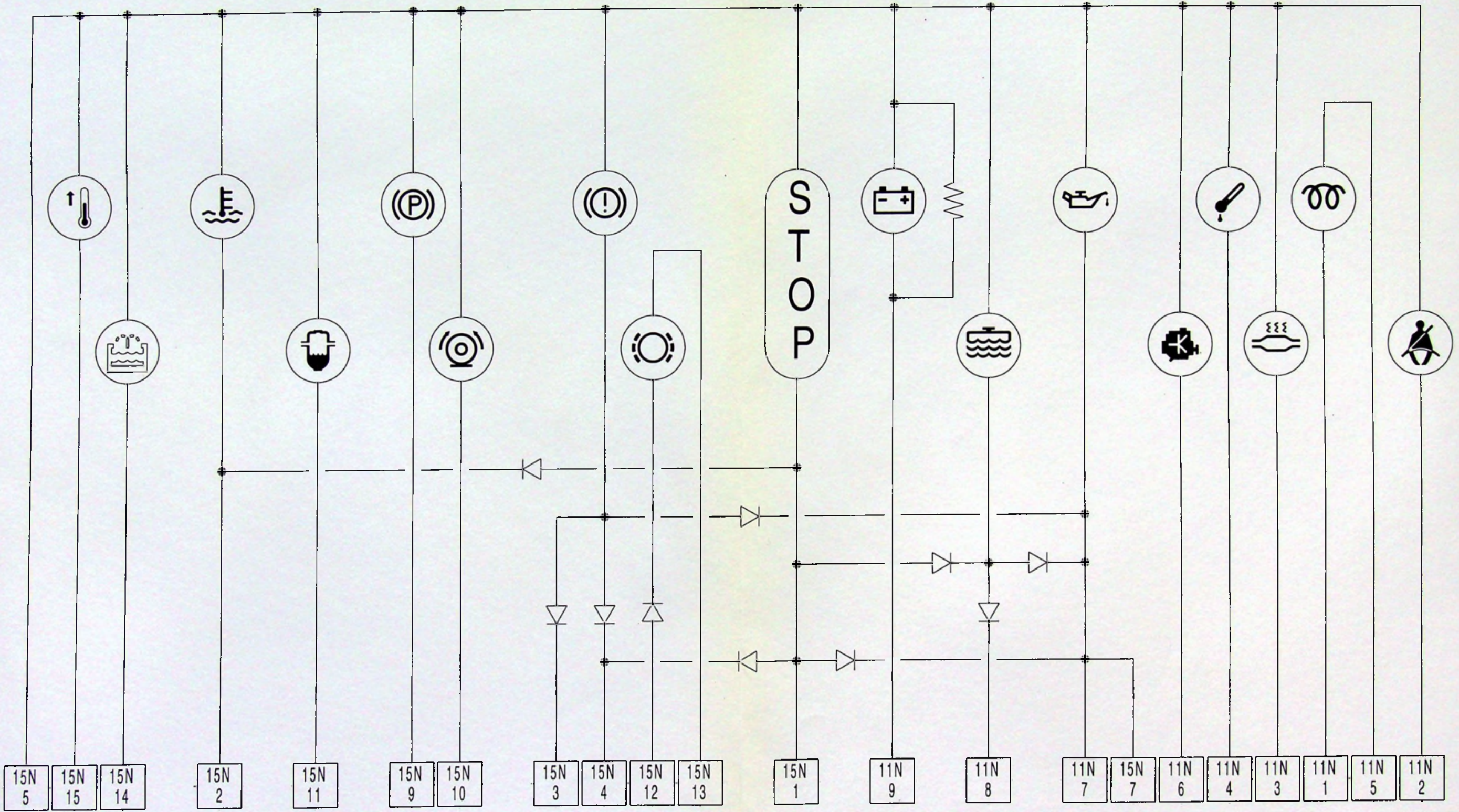





52

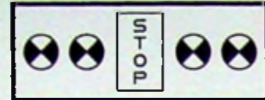

XM  
521-0/10a

4

5

XM  
521-0/10a



52

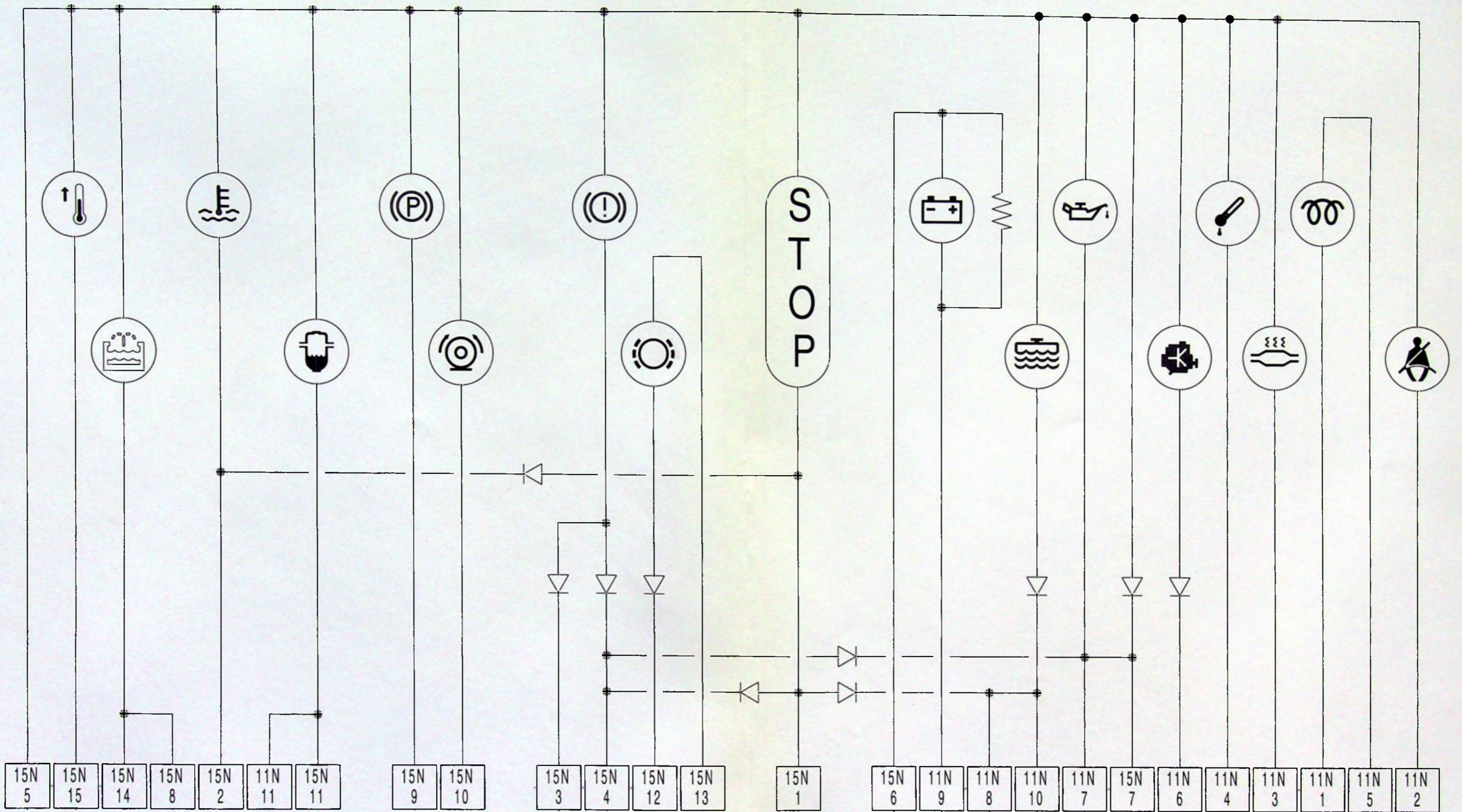





52

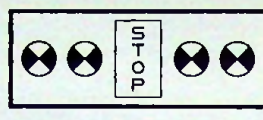

XM  
521-0/10b

4

5

XM  
521-0/10b

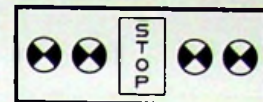

52

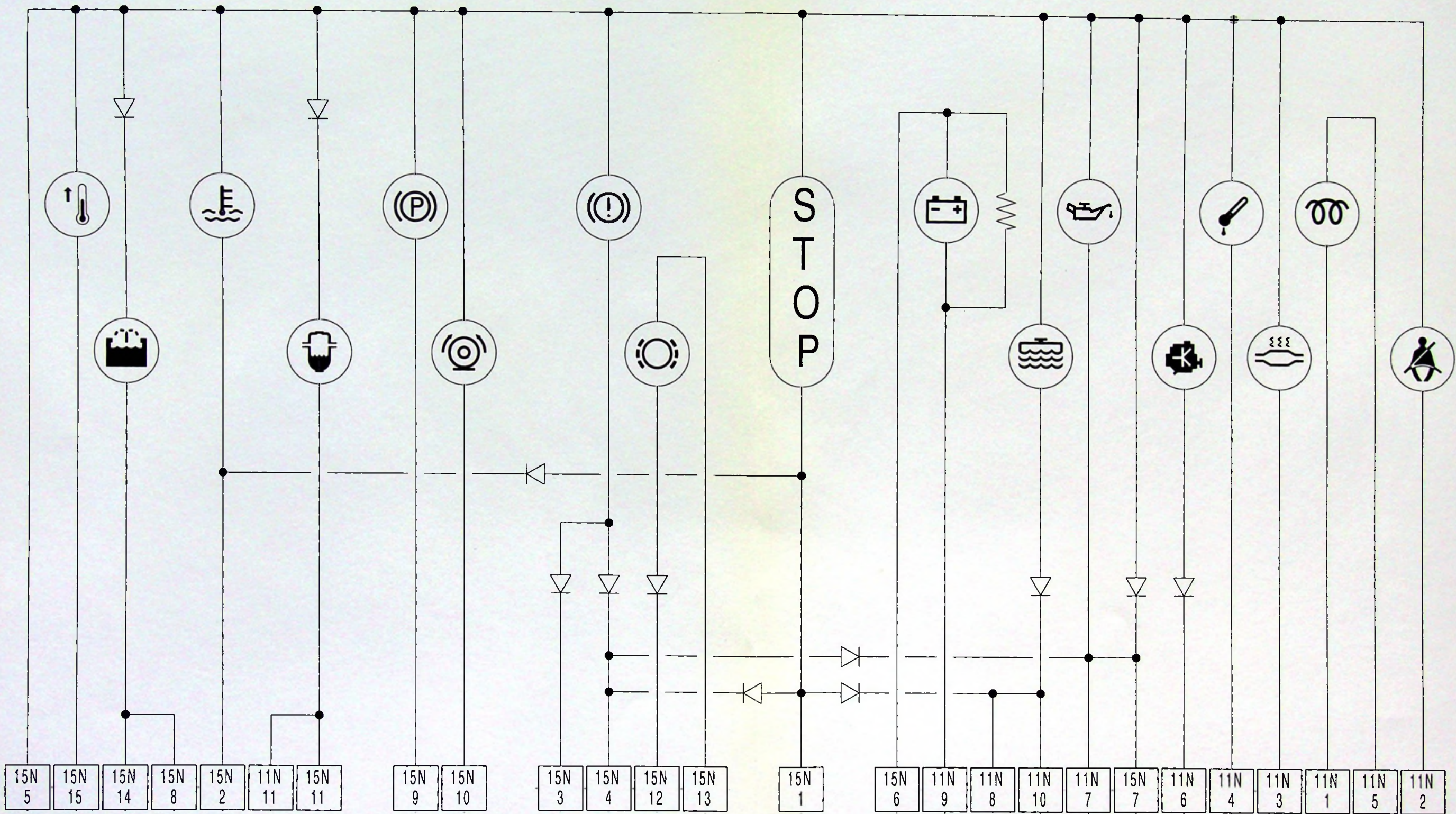





52

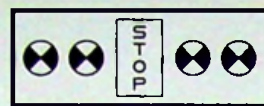

XM  
521-1/11

4

5

XM  
521-1/11

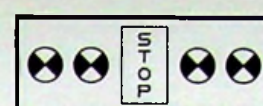

52

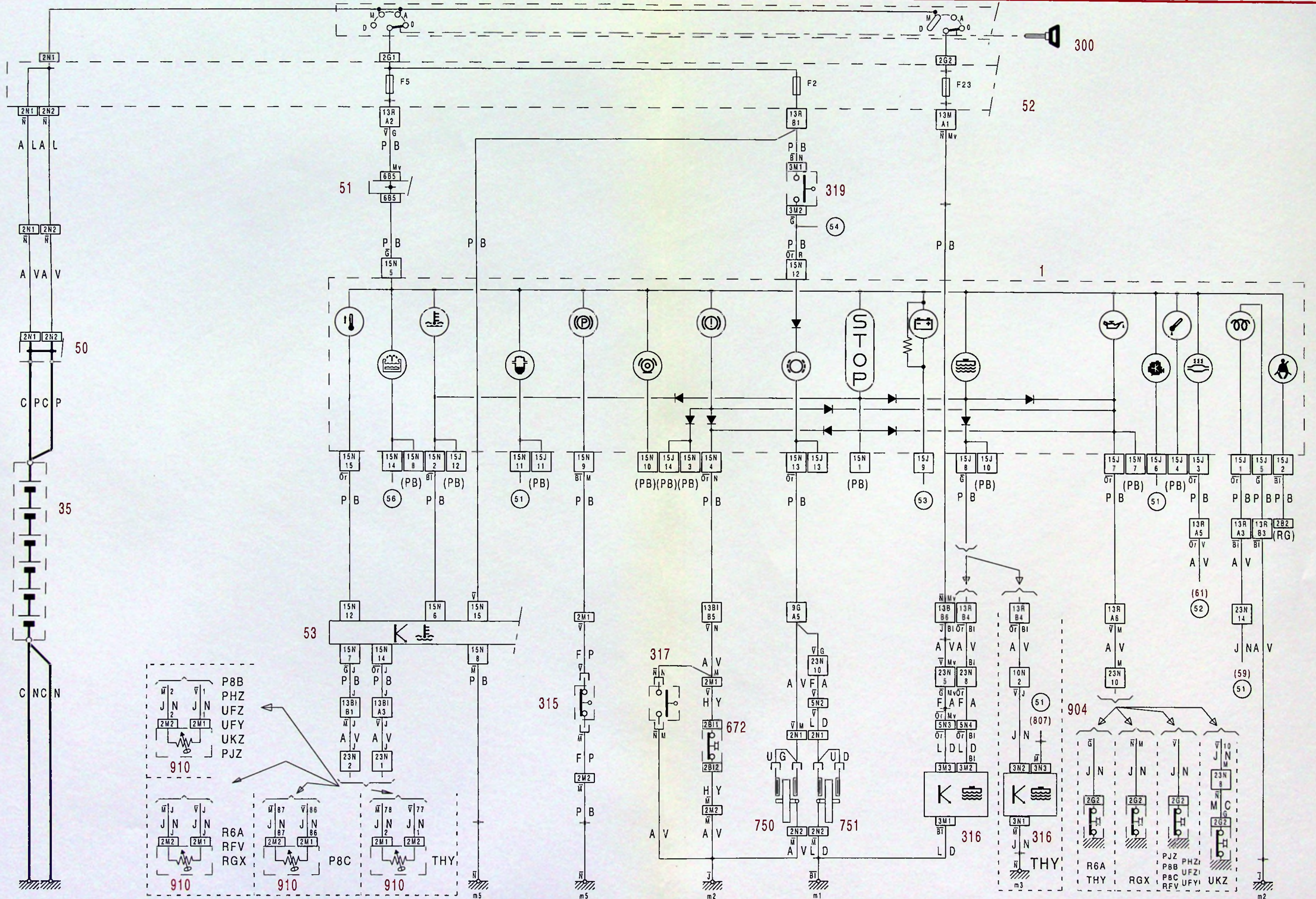

1 2 3 4 5 6 7 8 9 10 11 12 13 14 15 16 17 18 19 20 21 22 23 24 25 26 27 28 29 30 31 32 33 34 35 36 37 38 39 40 41 42 43 44 45 46 47 48 49 50 51 52 53 54 55 56 57 58 59 60 61 62

























52

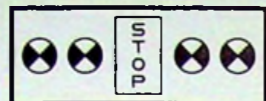

XM  
521-2/11

4

5

XM  
521-2/11

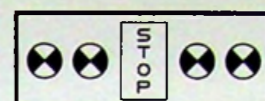

52

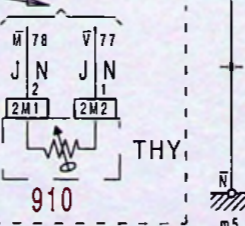
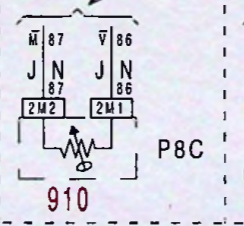
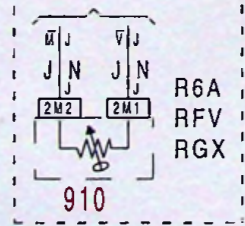
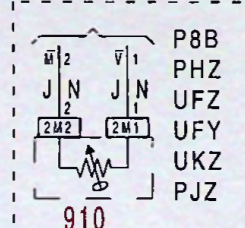
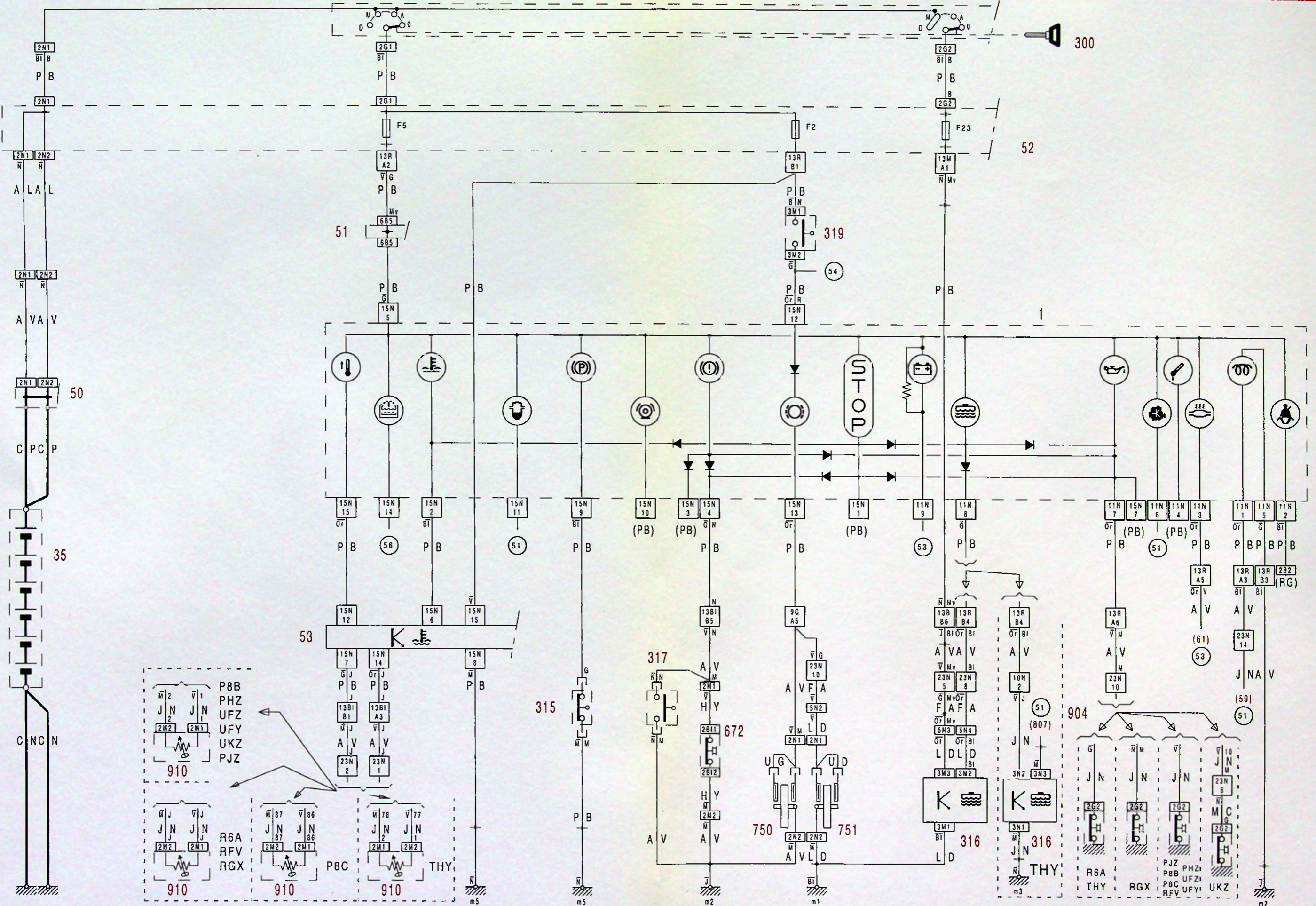

1 2 3 4 5 6 7 8 9 10 11 12 13 14 15 16 17 18 19 20 21 22 23 24 25 26 27 28 29 30 31 32 33 34 35 36 37 38 39 40 41 42 43 44 45 46 47 48 49 50 51 52 53 54 55 56 57 58 59 60 61 62

521-2/11

521-2/11





52

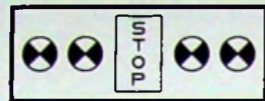

XM  
521-2/11a

4

5

XM  
521-2/11a

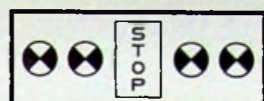

52

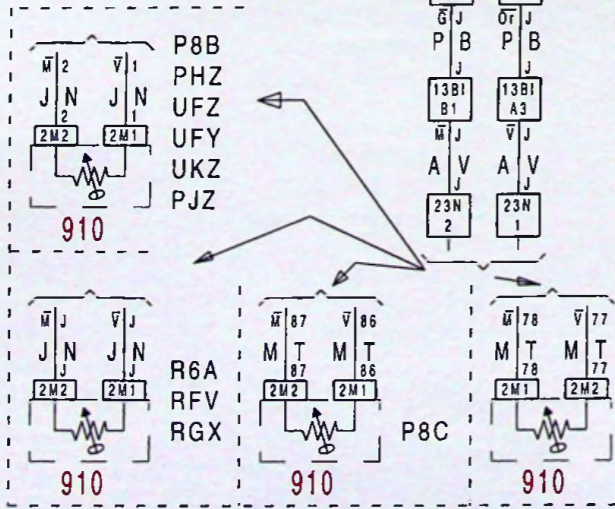
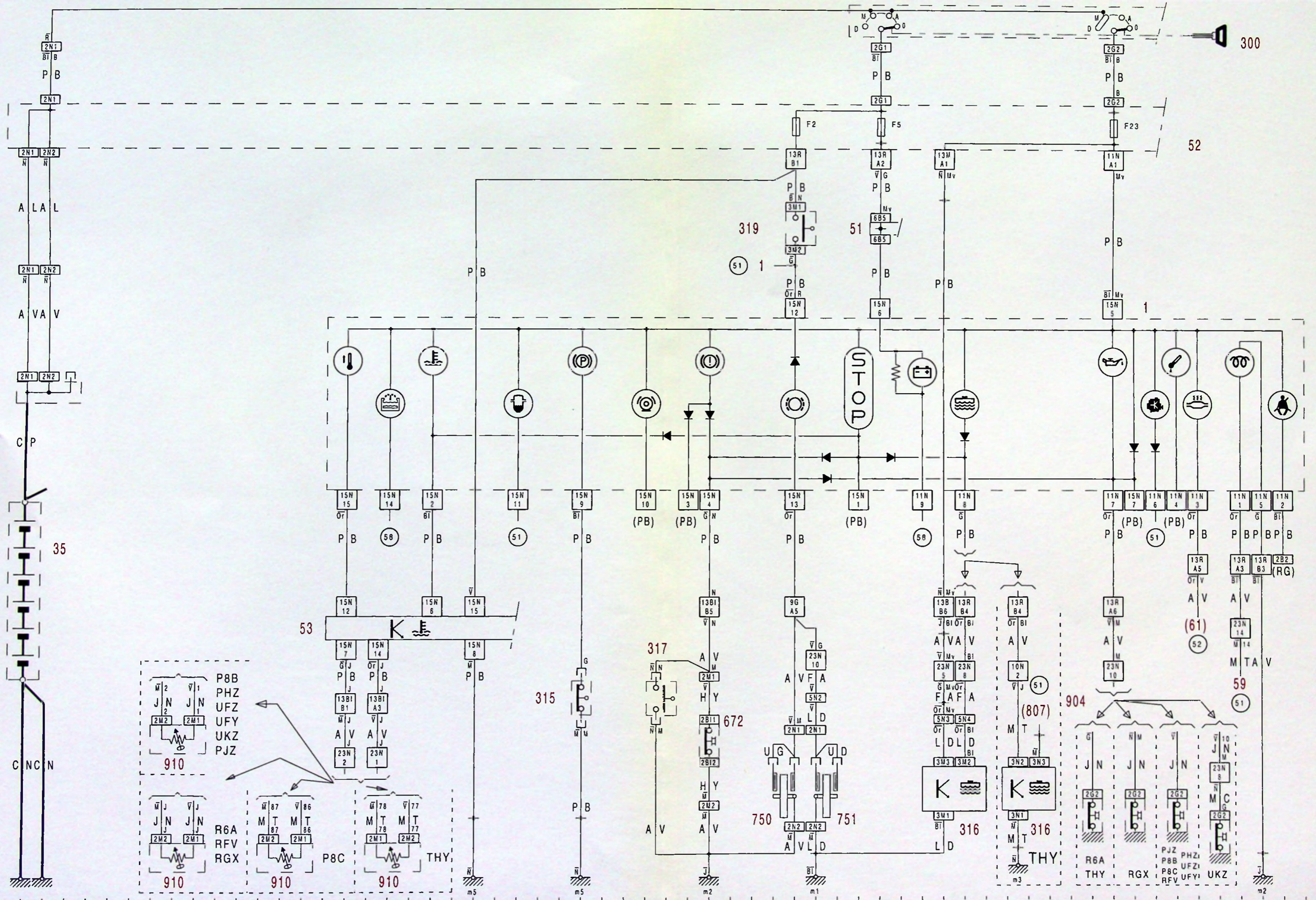

521-2/11a

521-2/11a

1 2 3 4 5 6 7 8 9 10 11 12 13 14 15 16 17 18 19 20 21 22 23 24 25 26 27 28 29 30 31 32 33 34 35 36 37 38 39 40 41 42 43 44 45 46 47 48 49 50 51 52 53 54 55 56 57 58 59 60 61 62





52

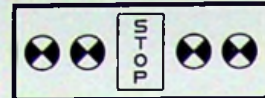

XM  
521-2/11b

4

5

XM  
521-2/11b



52

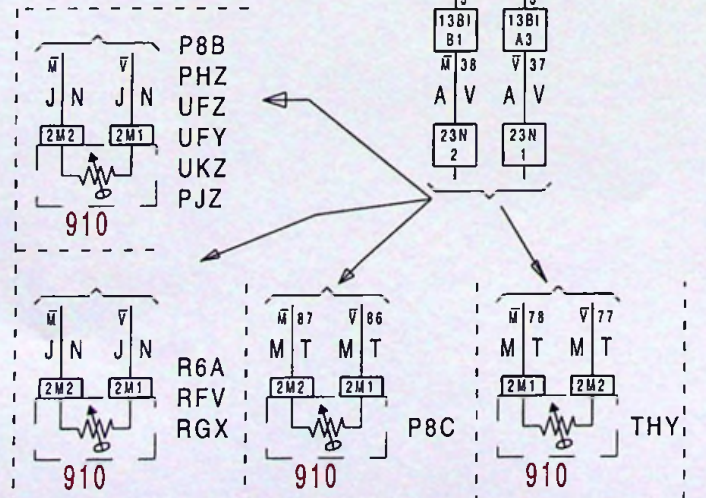
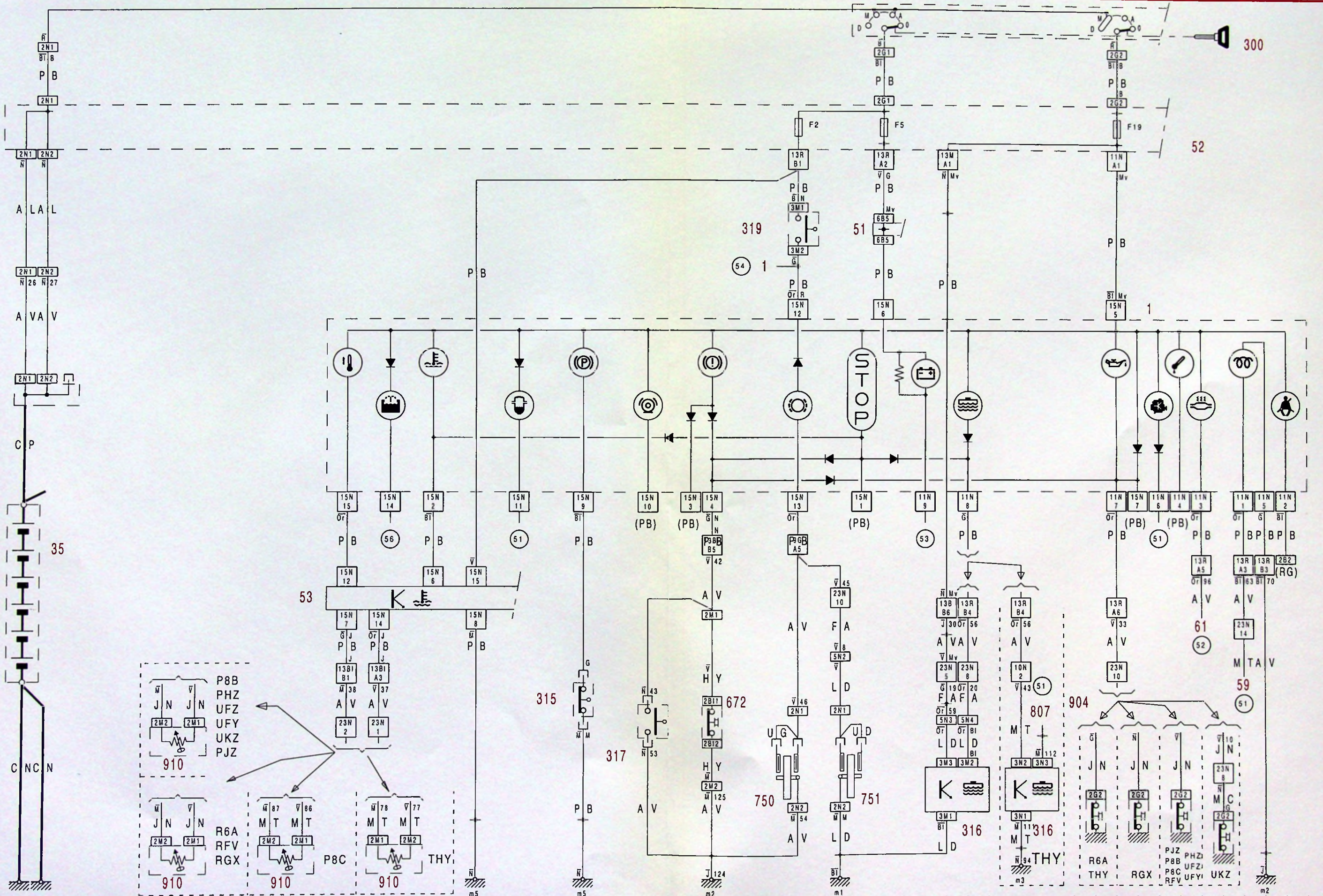

521-2/11b

521-2/11b













52



XM  
521-2/11e

4

5

XM  
521-2/11e



52

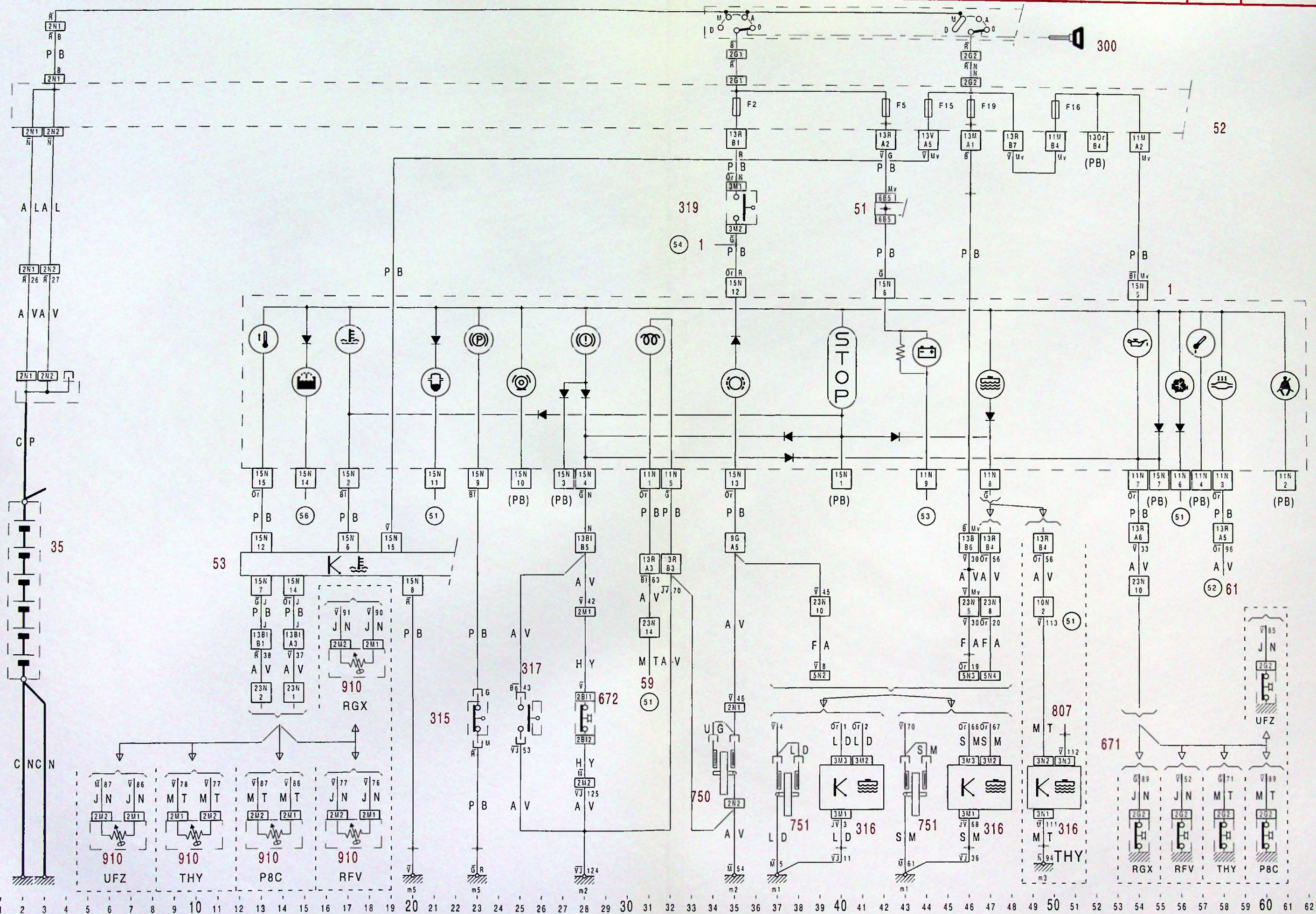

521-2/11e

521-2/11e





52

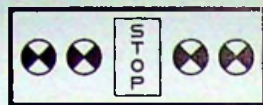

XM  
522-0/10

4

5

XM  
522-0/10

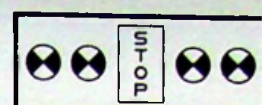

52

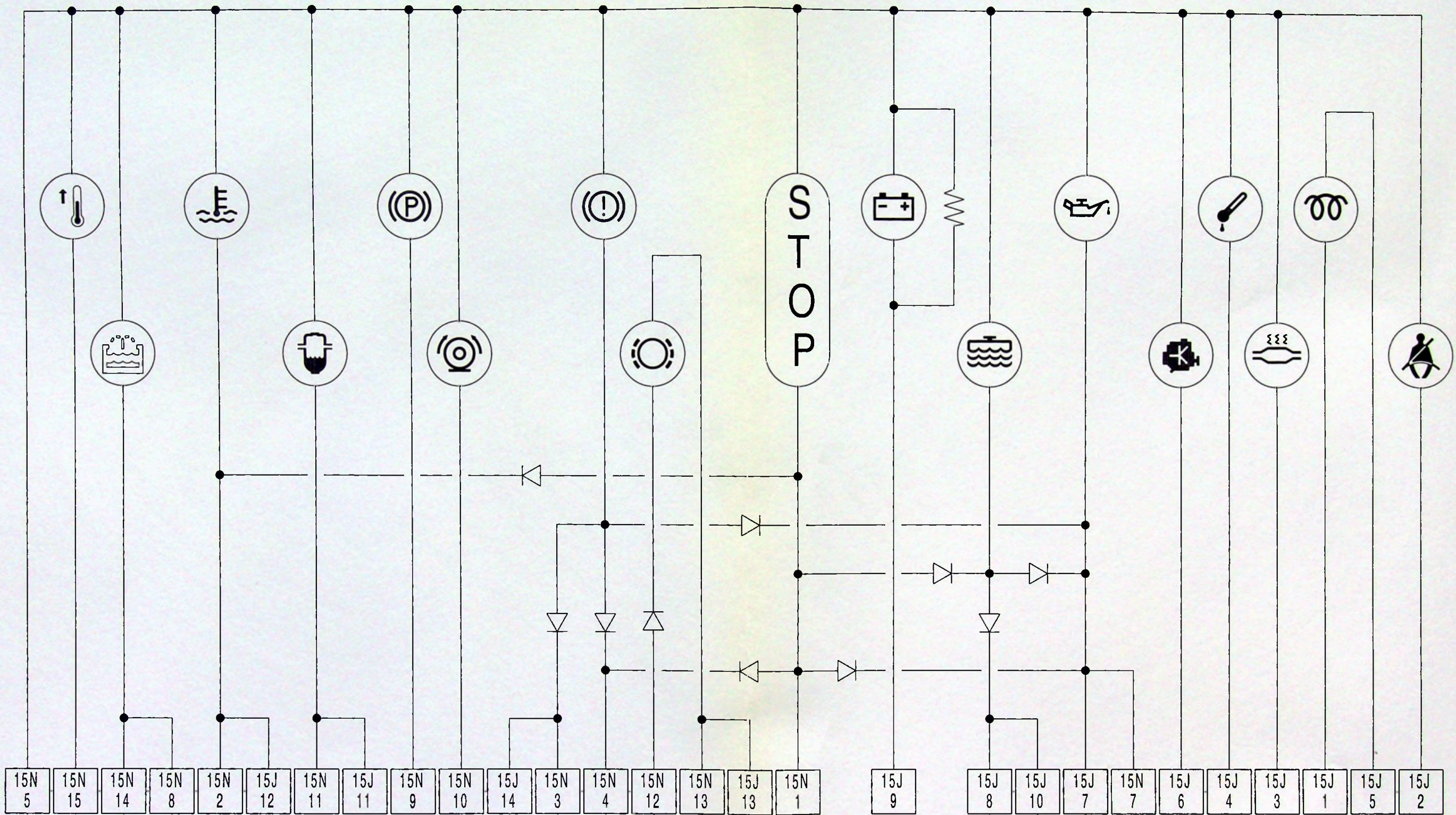









52

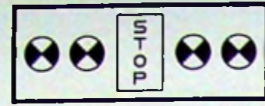

XM  
522-0/10b

4

5

XM  
522-0/10b

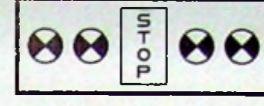

52

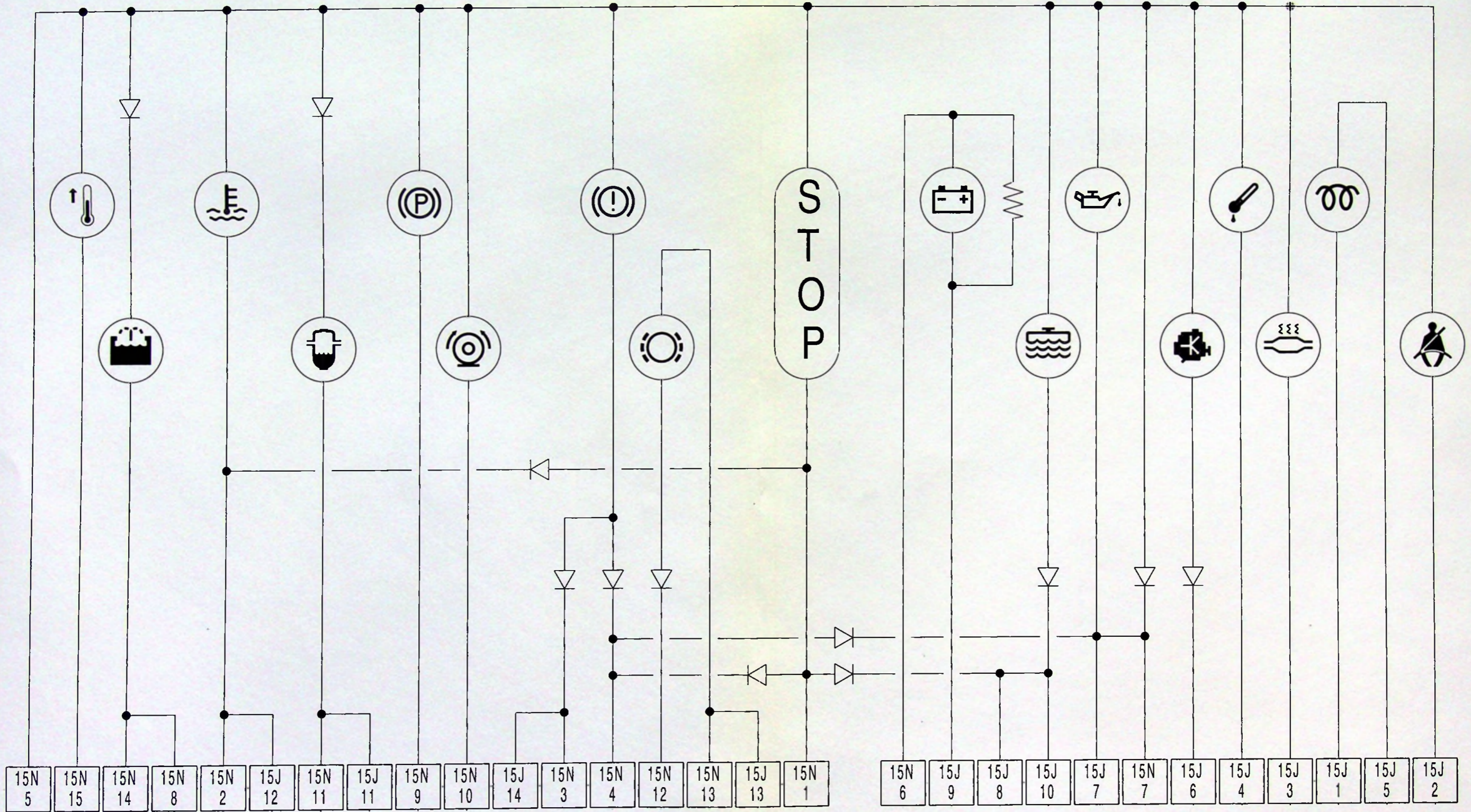













52



XM 522-1/11b

4

5

XM 522-1/11b

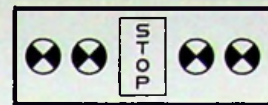

52

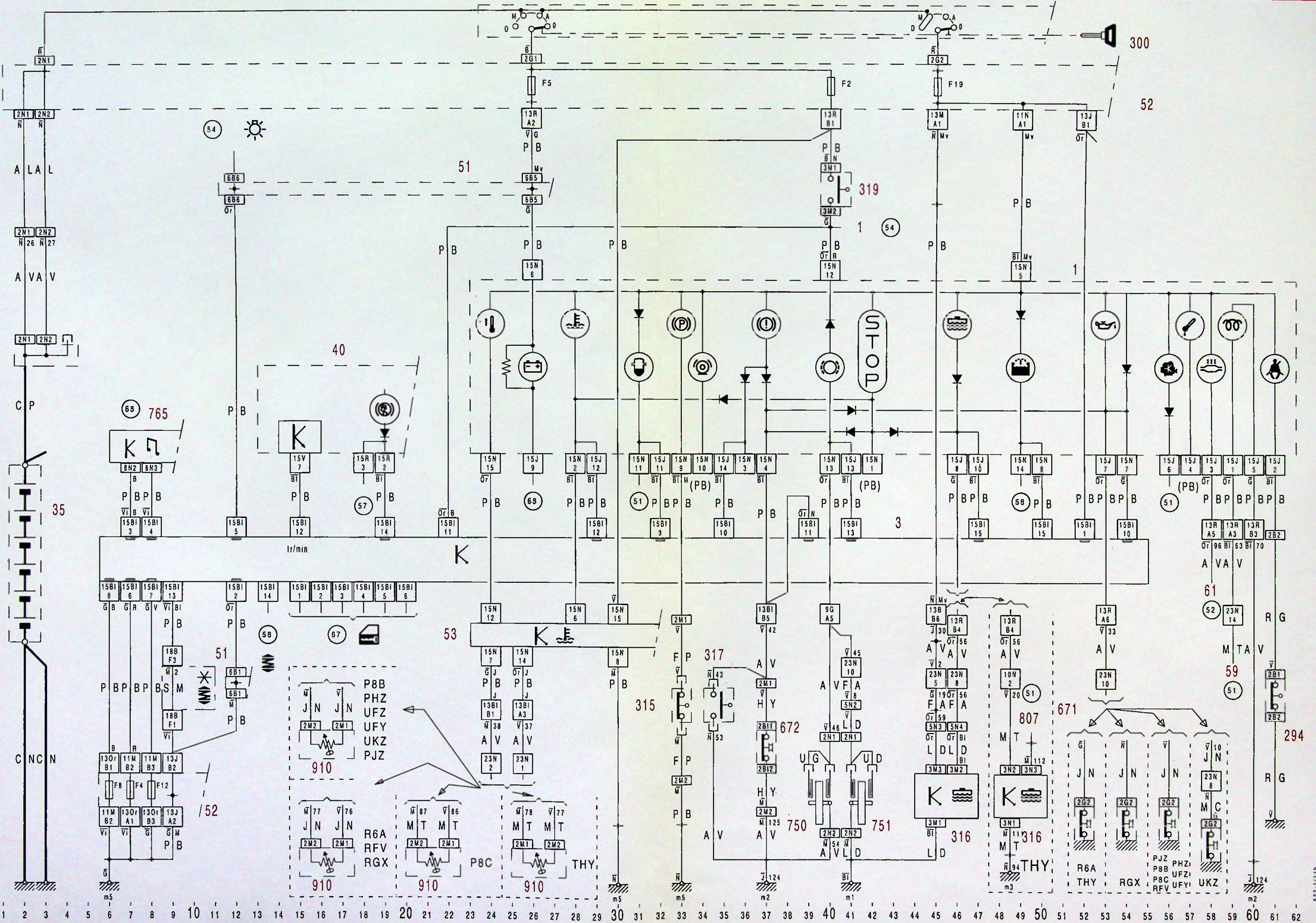

522-1/11b

522-1/11b









52

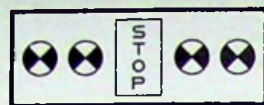

XM  
522-1/11d

4

5

XM  
522-1/11d

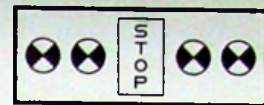

52

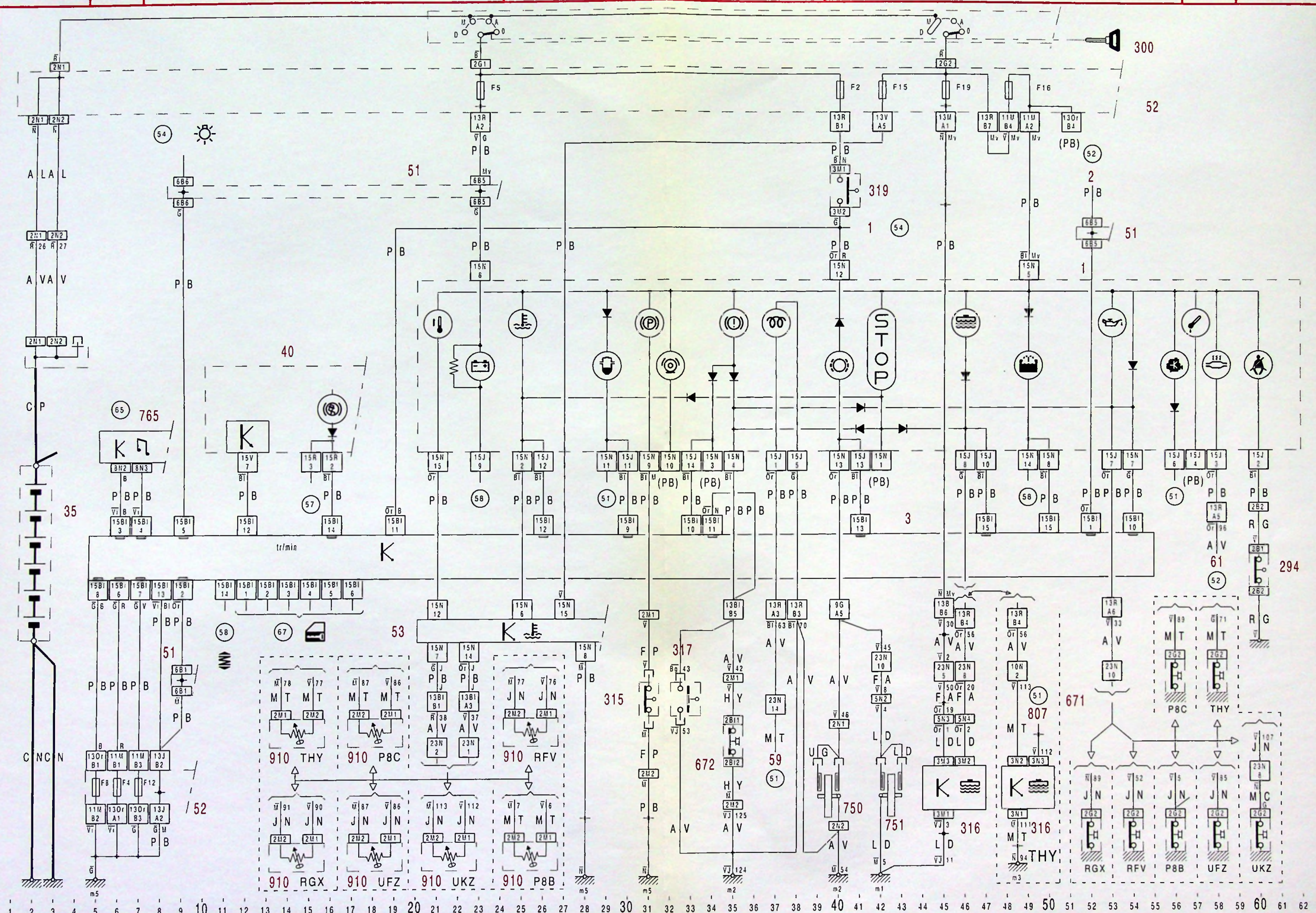

1 2 3 4 5 6 7 8 9 10 11 12 13 14 15 16 17 18 19 20 21 22 23 24 25 26 27 28 29 30 31 32 33 34 35 36 37 38 39 40 41 42 43 44 45 46 47 48 49 50 51 52 53 54 55 56 57 58 59 60 61 62





52



XM  
522-1/11e

4

5

XM  
522-1/11e

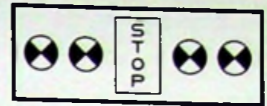

52

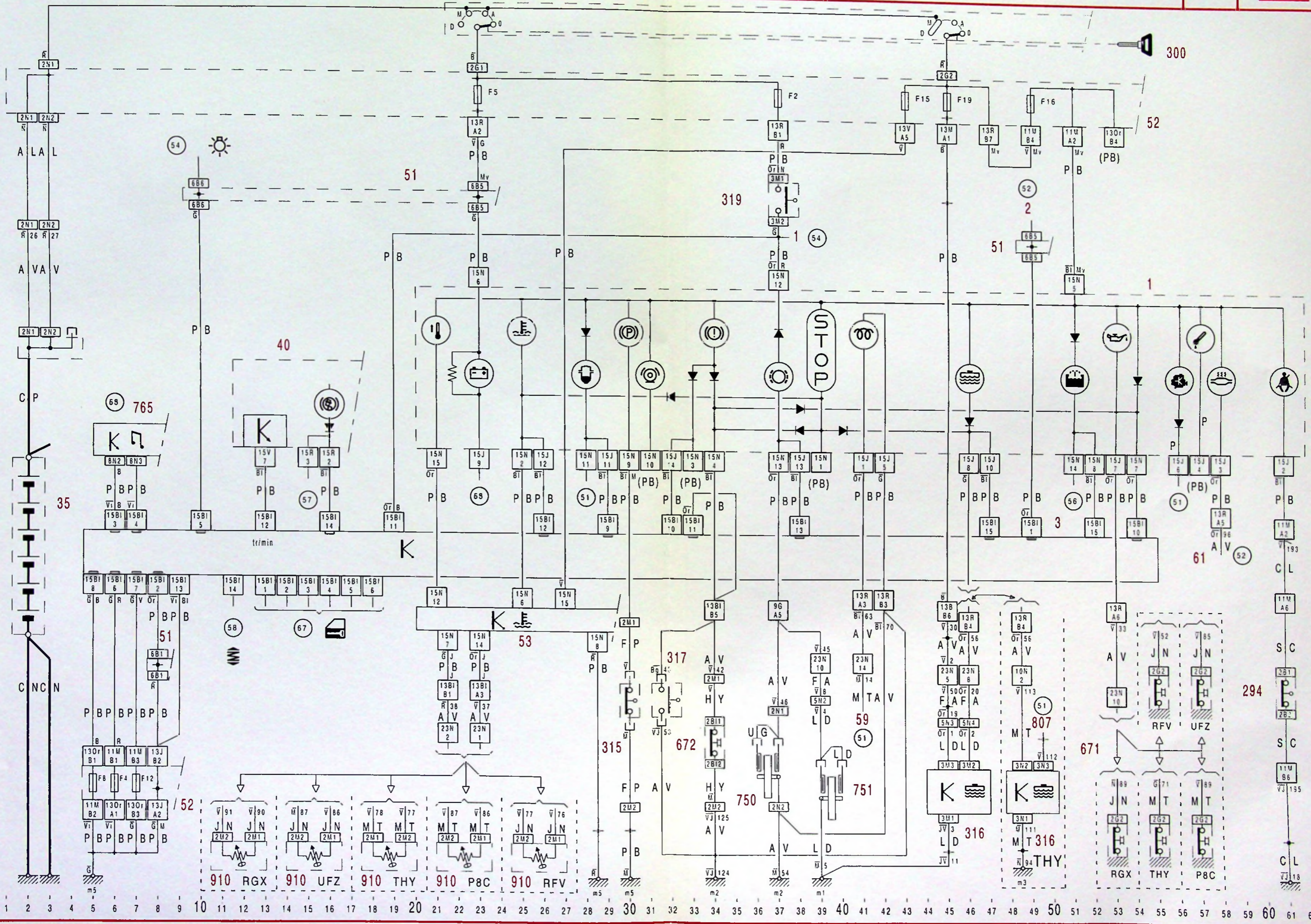

522-1/11e

522-1/11e





52



XM  
522-1/11f

3

4

XM  
522-1/11f

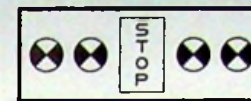

52

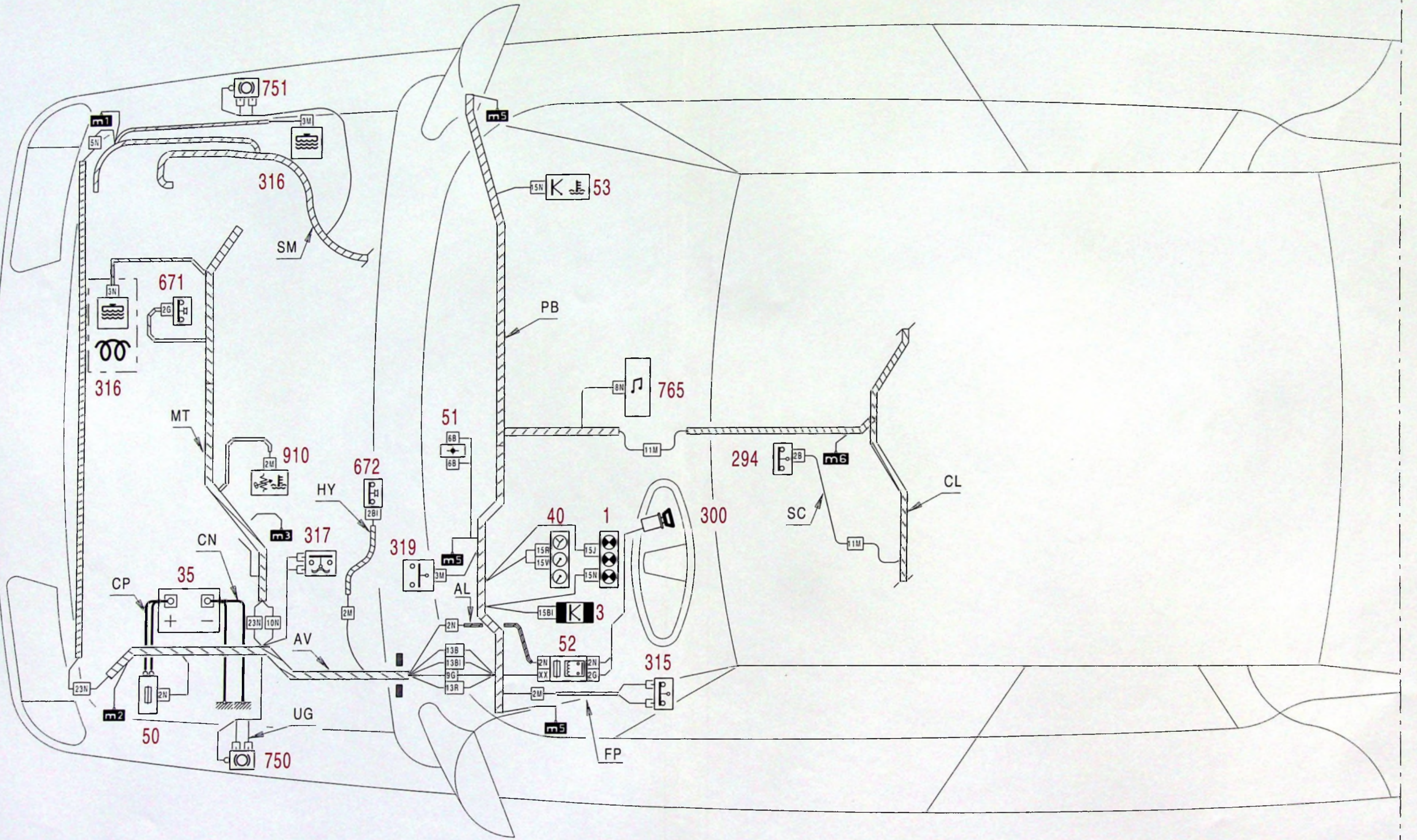









52

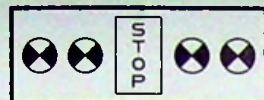

XM 522-1/11g

6

7

XM 522-1/11g



52

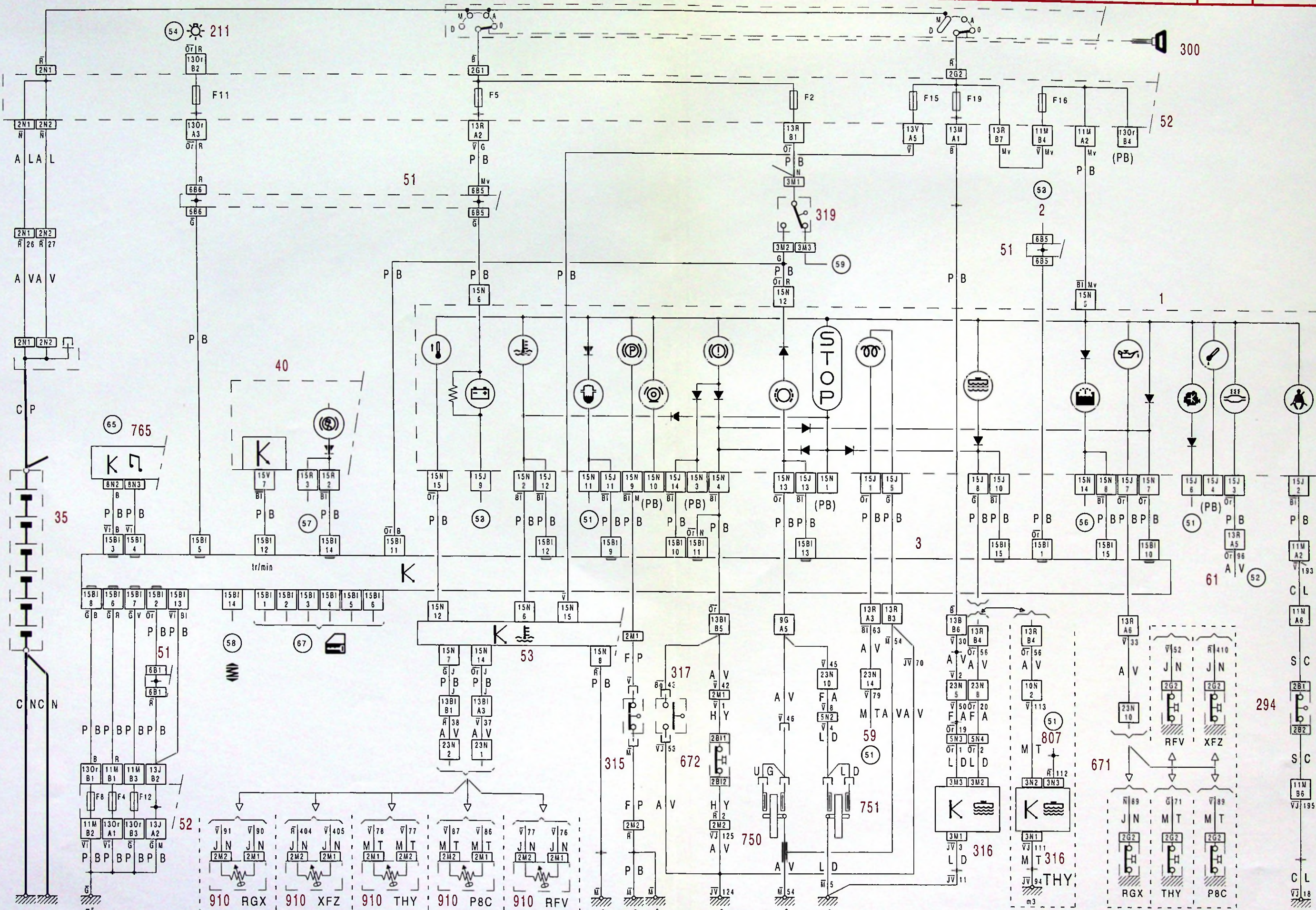

1 2 3 4 5 6 7 8 9 10 11 12 13 14 15 16 17 18 19 20 21 22 23 24 25 26 27 28 29 30 31 32 33 34 35 36 37 38 39 40 41 42 43 44 45 46 47 48 49 50 51 52 53 54 55 56 57 58 59 60 61 62













52

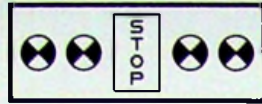

XM 522-2/11b

4

5

XM 522-2/11b

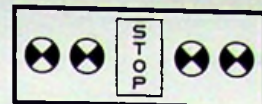

52

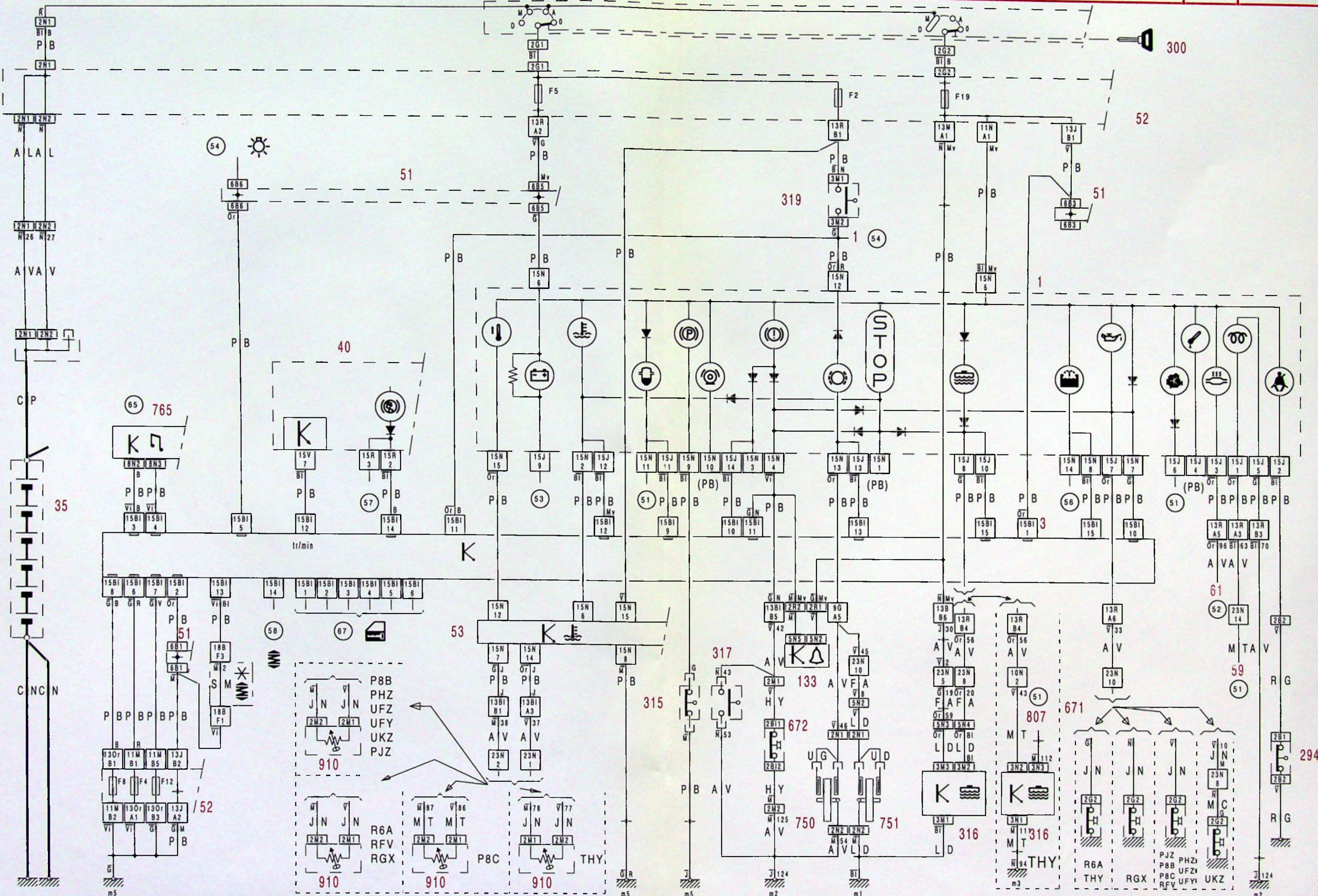

1 2 3 4 5 6 7 8 9 10 11 12 13 14 15 16 17 18 19 20 21 22 23 24 25 26 27 28 29 30 31 32 33 34 35 36 37 38 39 40 41 42 43 44 45 46 47 48 49 50 51 52 53 54 55 56 57 58 59 60 61 62

522-2/11b

522-2/11b













52

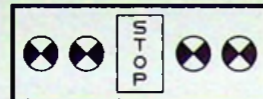

XM  
522-2/11e

4

5

XM  
522-2/11e



52

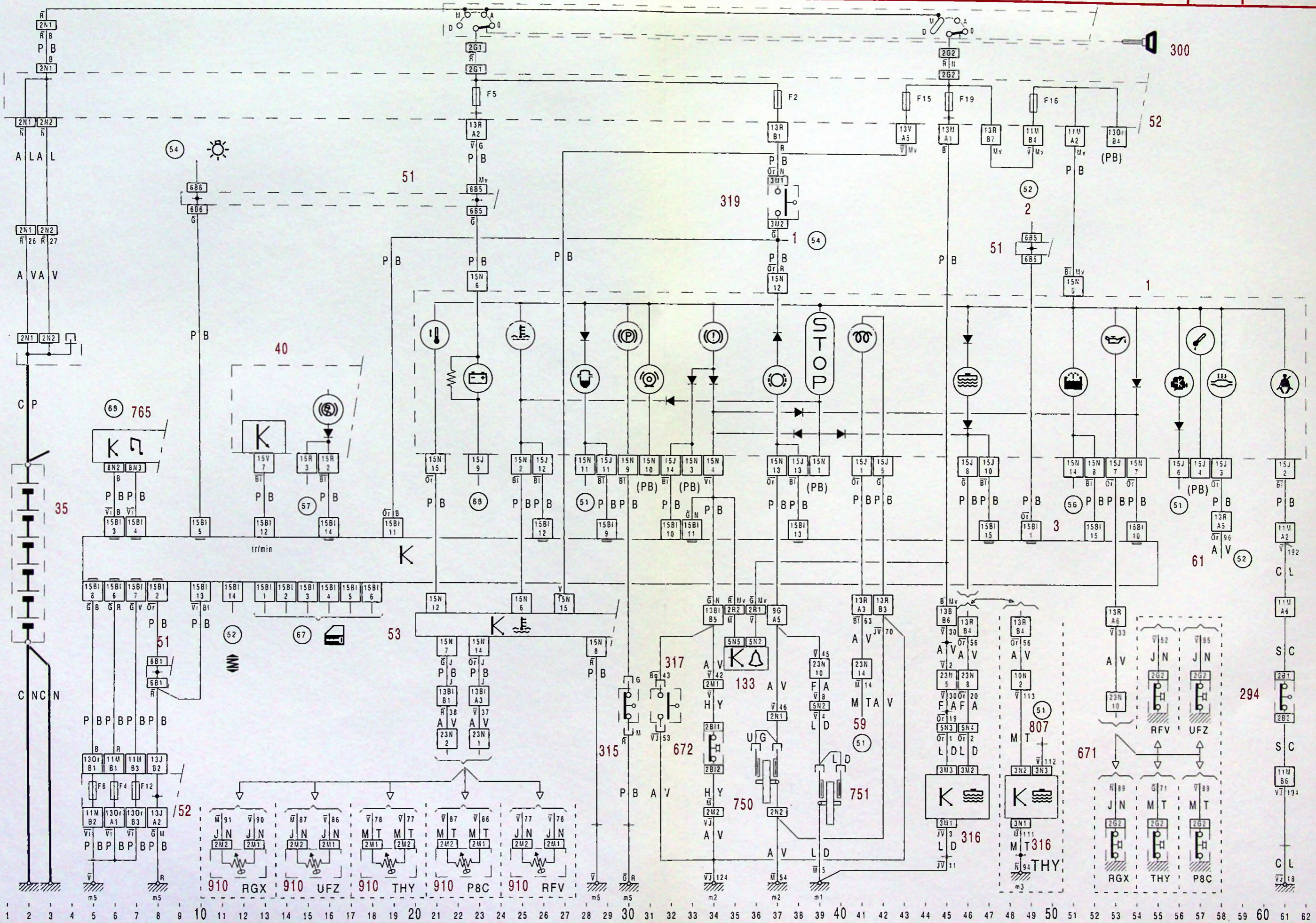

522-2/11e

522-2/11e





52

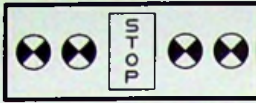

XM  
522-2/11f

4

5

XM  
522-2/11f



52

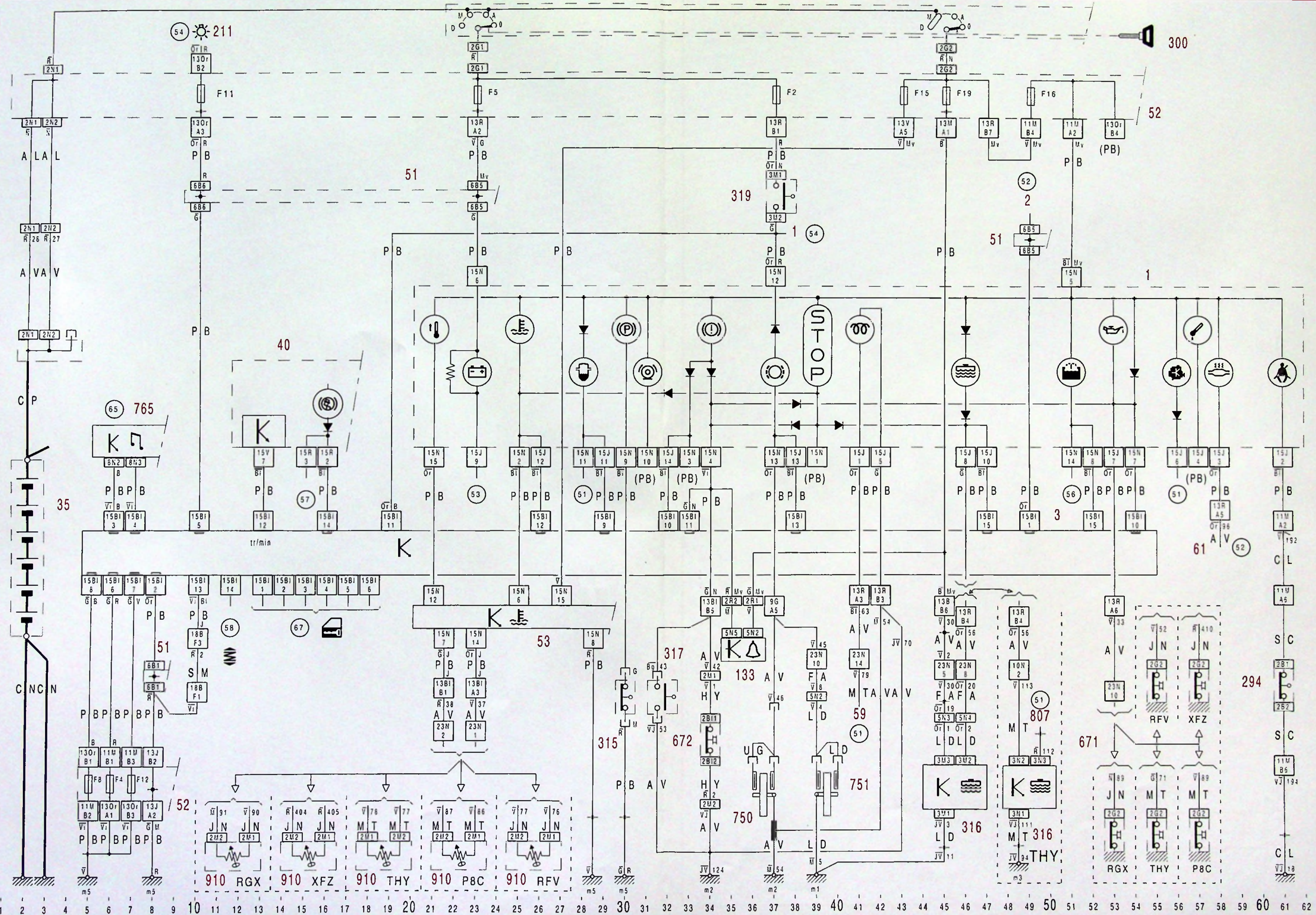

522-2/11f

522-2/11f





52



XM  
523-1/11

3

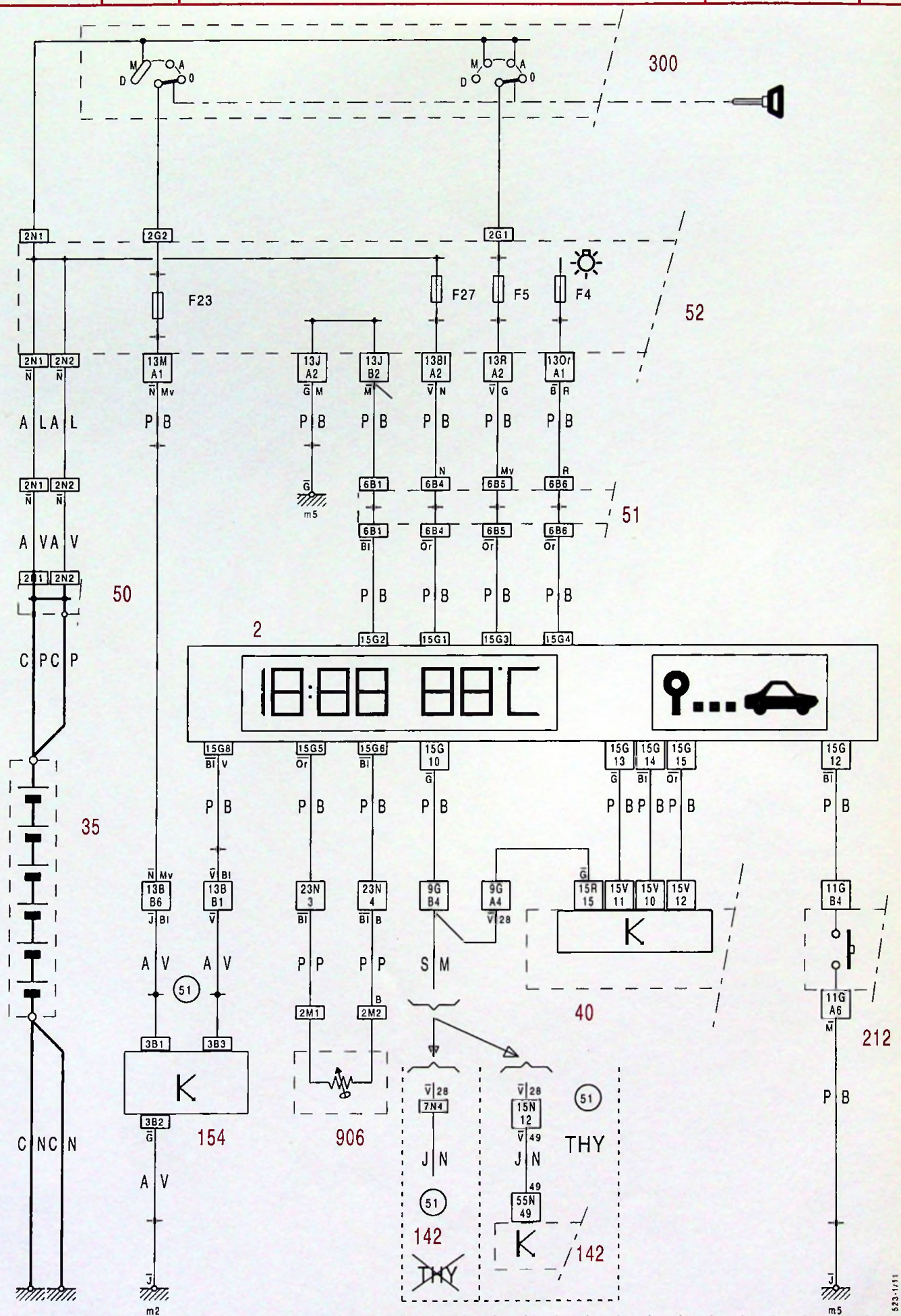

523-1/11

523-1/11





52

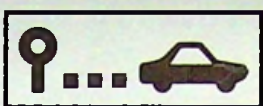

XM  
523-1/11a

3

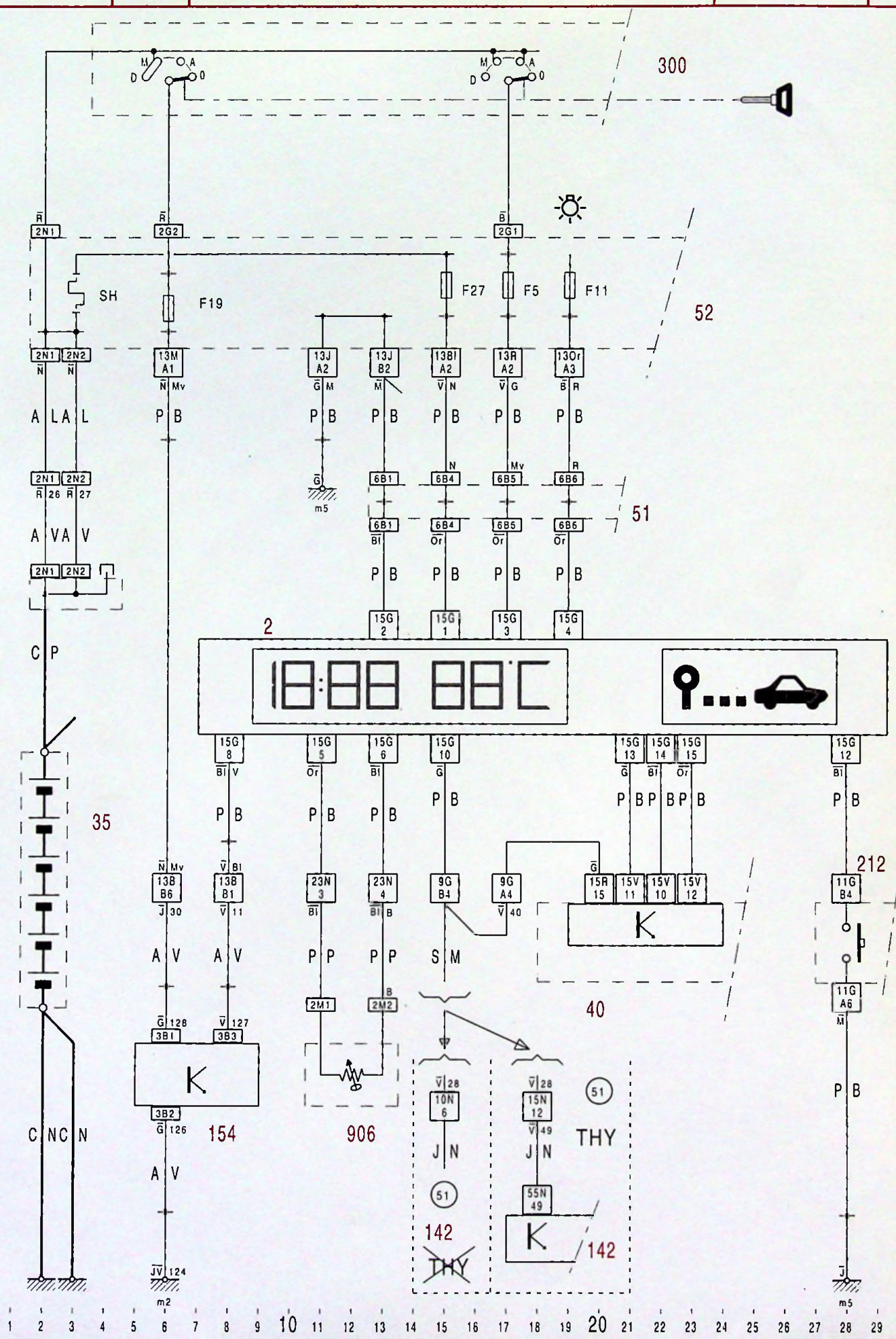



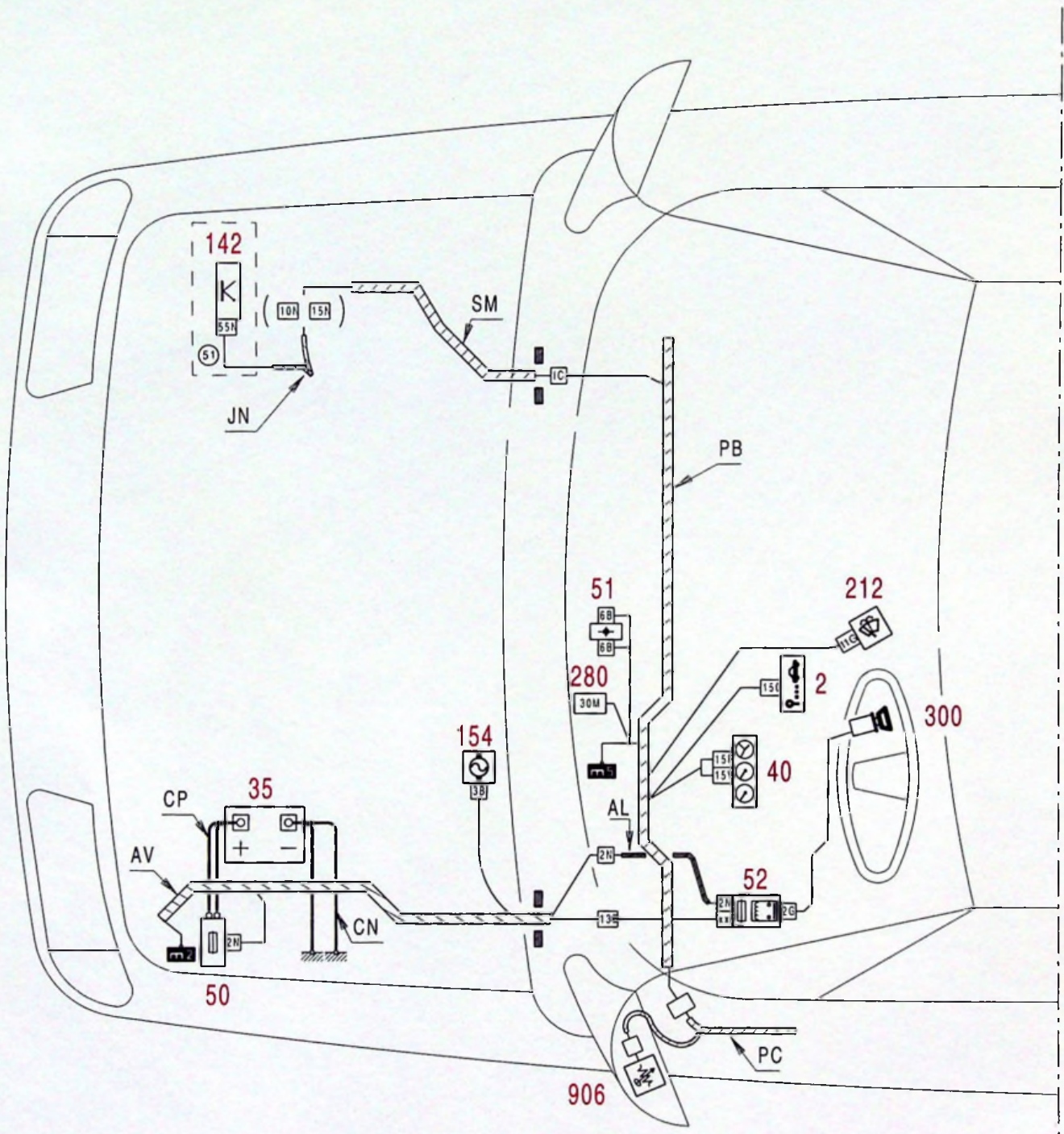





52



XM  
523-1/11b

3

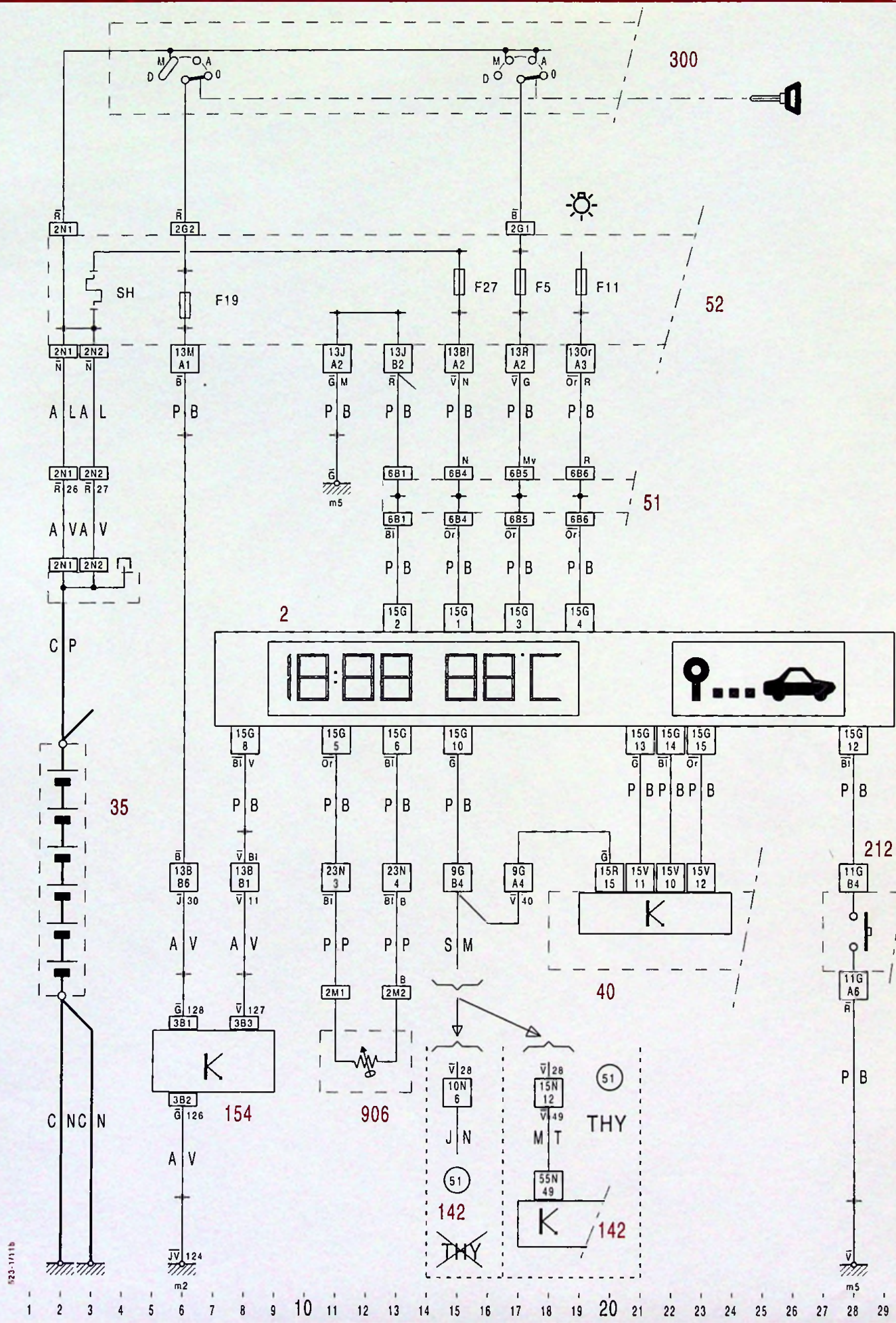

523-1/11b

523-1/11b

1 2 3 4 5 6 7 8 9 10 11 12 13 14 15 16 17 18 19 20 21 22 23 24 25 26 27 28 29



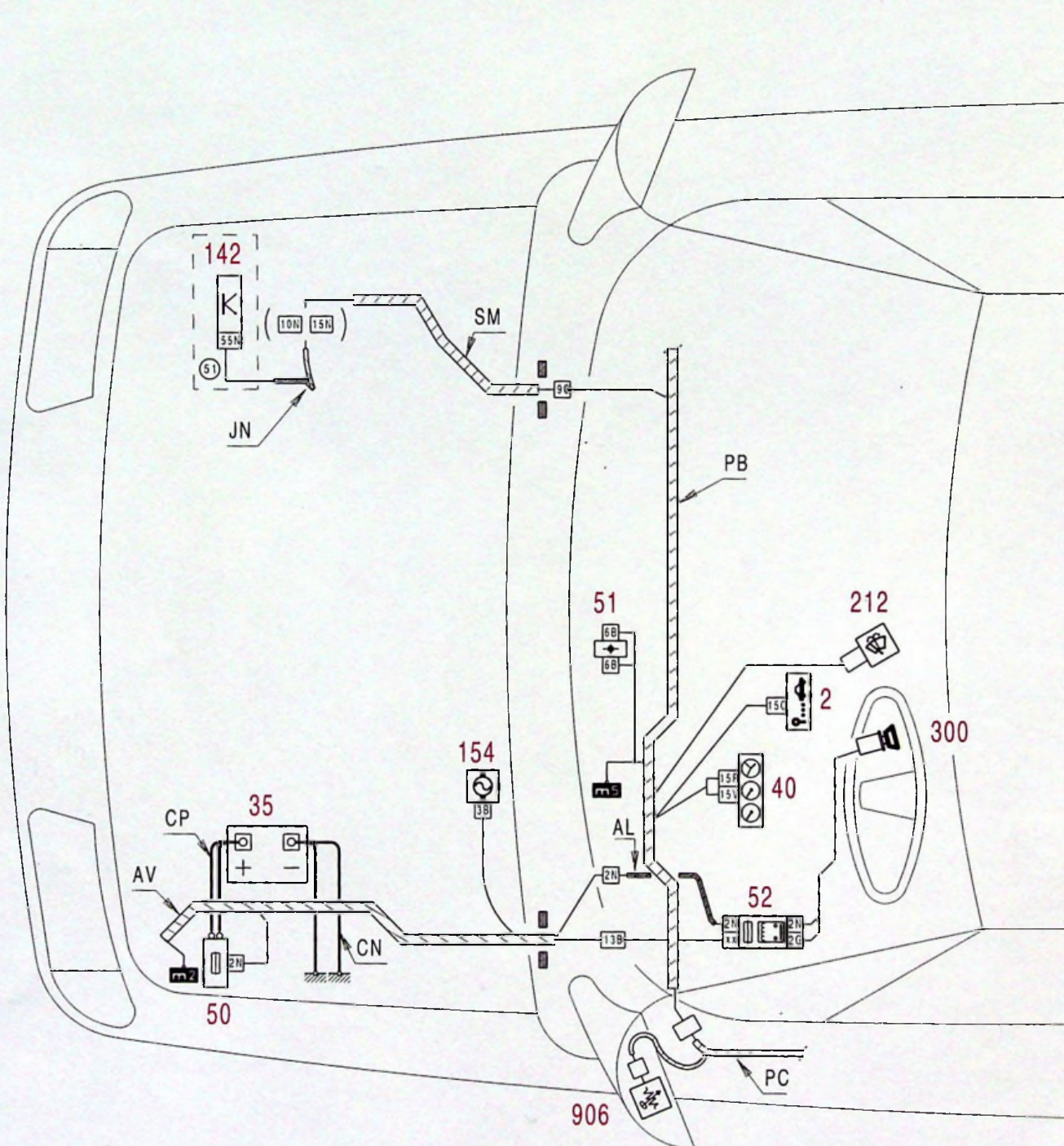
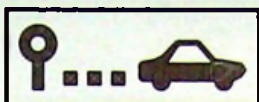





52



XM  
523-1/11c

3

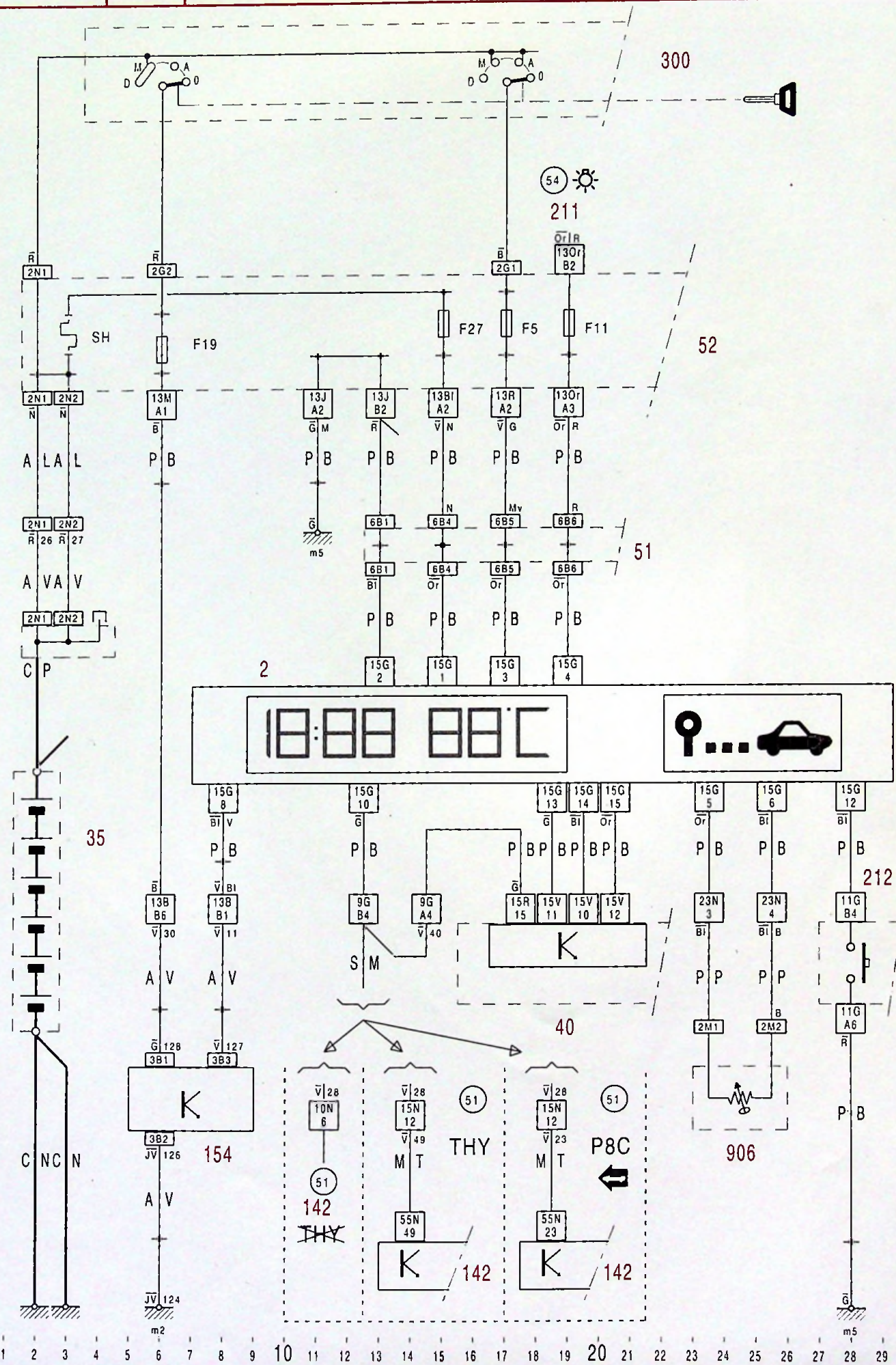





52

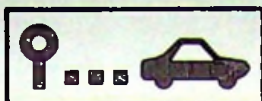

XM  
523-1/11c

3

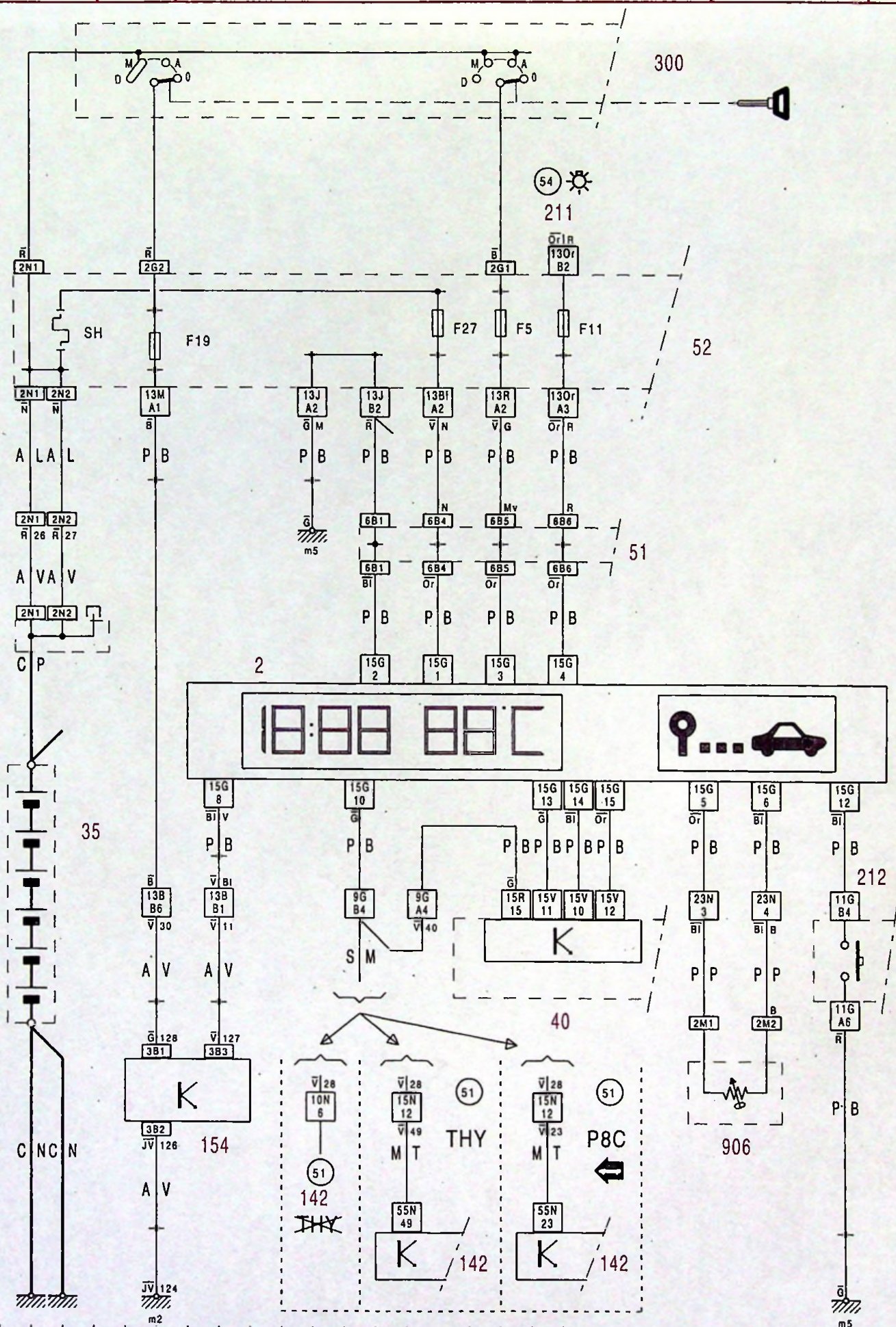

523-1/11c

523-1/11c

1 2 3 4 5 6 7 8 9 10 11 12 13 14 15 16 17 18 19 20 21 22 23 24 25 26 27 28 29





52

18:88 88°C

XM  
523-1/21

3

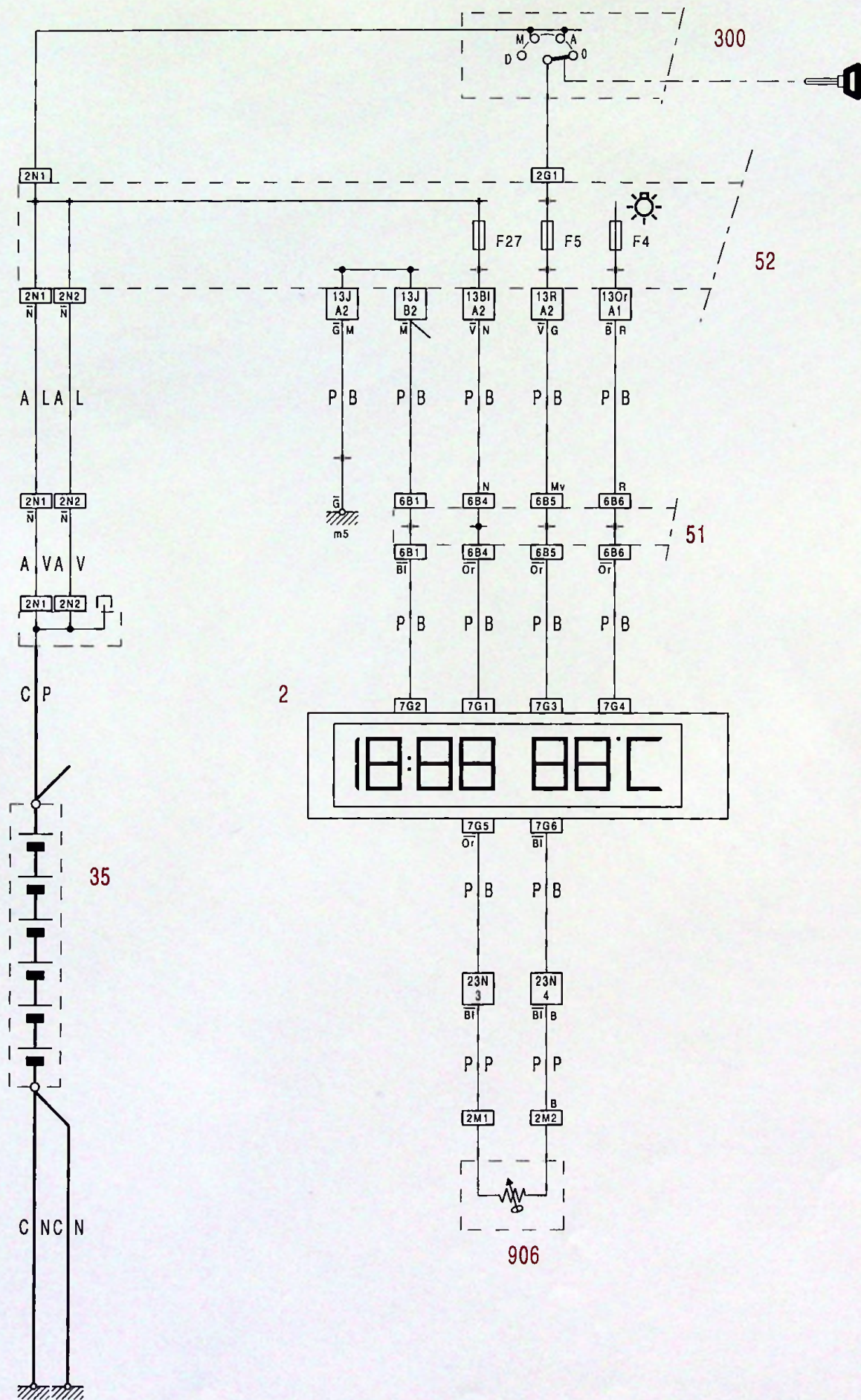

523-1/21

523-1/21

1 2 3 4 5 6 7 8 9 10 11 12 13 14 15 16 17 18 19 20 21 22 23 24 25 26 27 28 29





52

18:00 88°C

XM  
523-1/21a

3

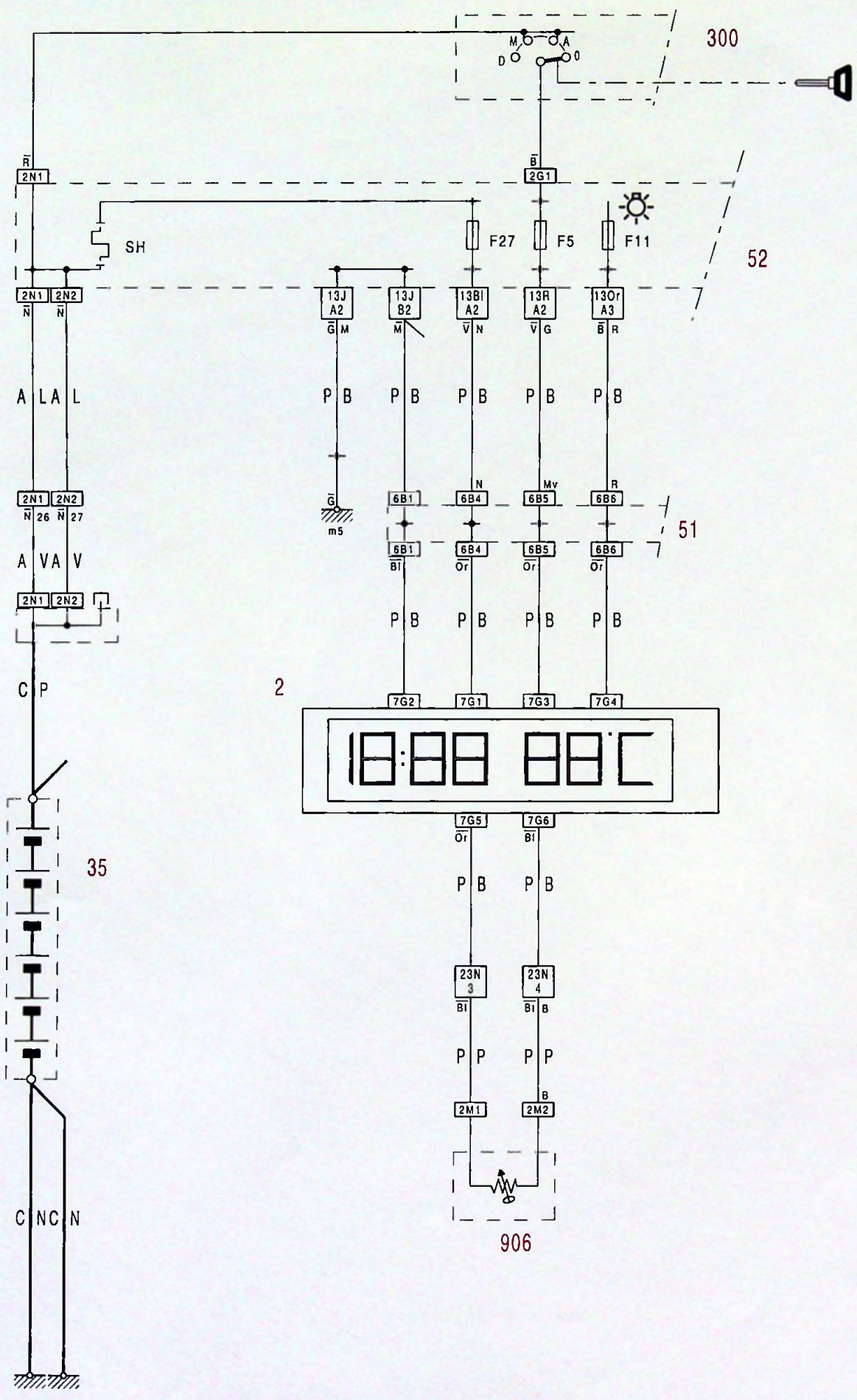

523-1/21a

523-1/21a

1 2 3 4 5 6 7 8 9 10 11 12 13 14 15 16 17 18 19 20 21 22 23 24 25 26 27 28 29





52

18:00 88°C

XM  
523-1/21b

3

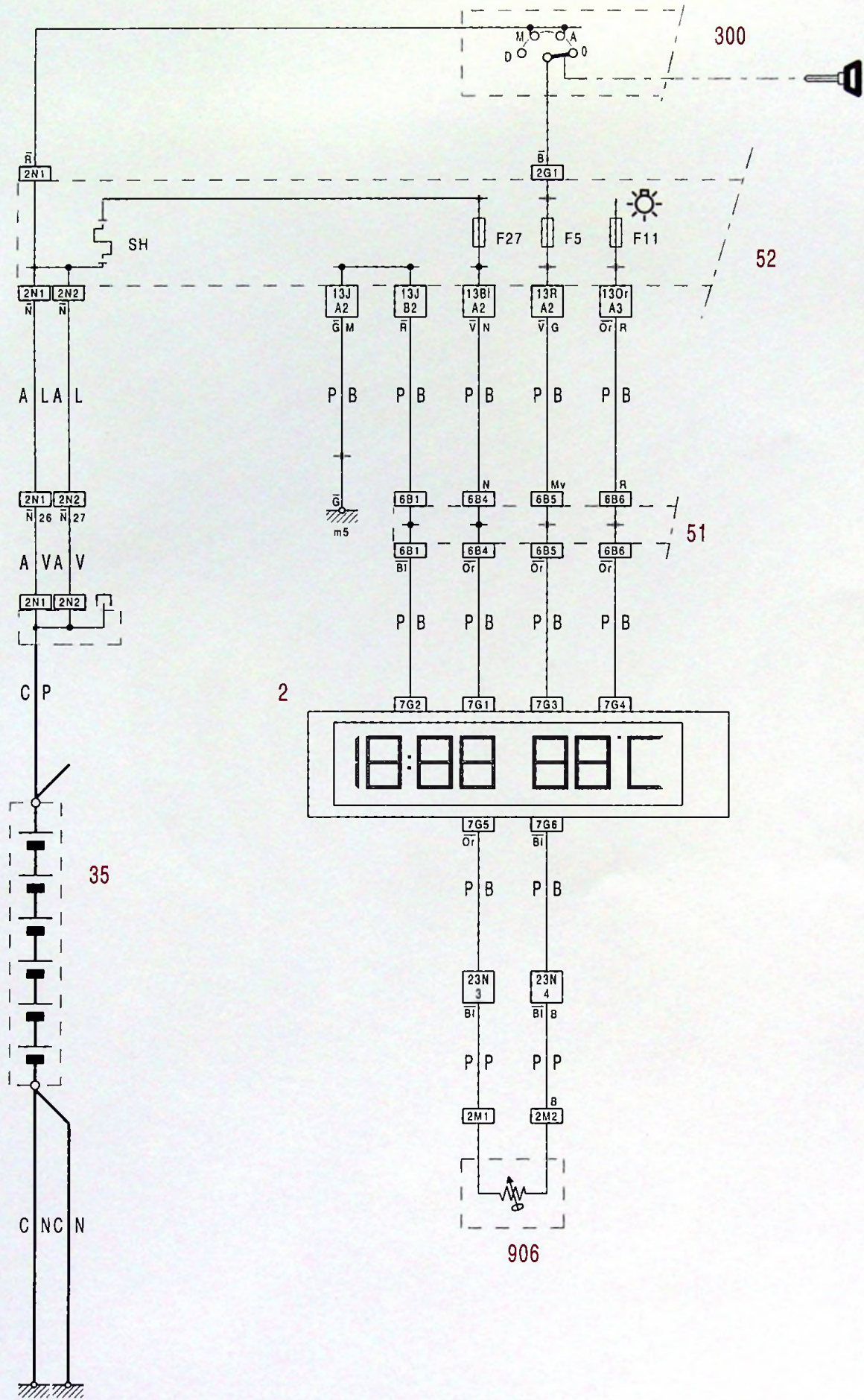

523-1/21b

523-1/21b

1 2 3 4 5 6 7 8 9 10 11 12 13 14 15 16 17 18 19 20 21 22 23 24 25 26 27 28 29





52

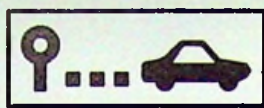

XM  
523-2/11

3

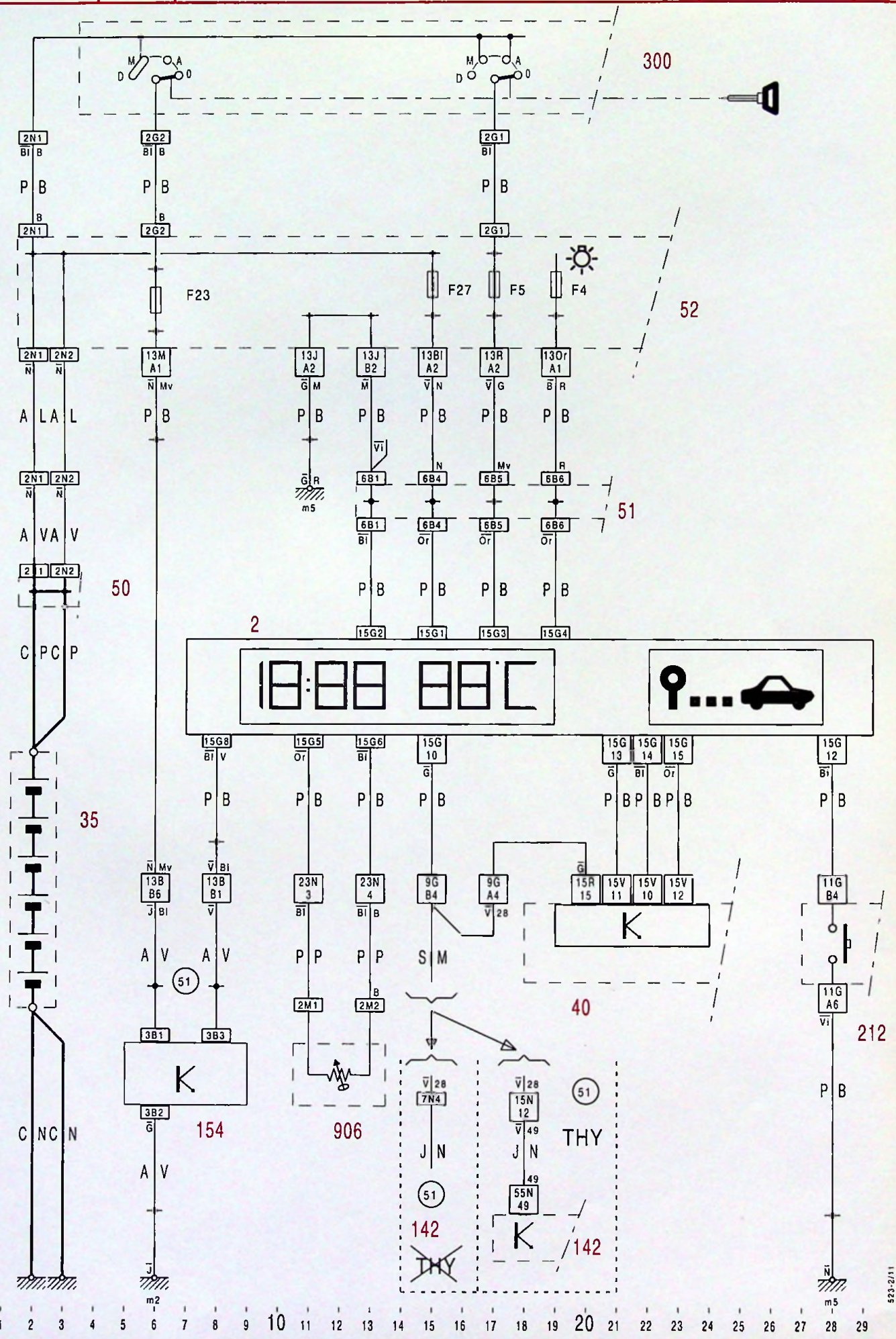

523-2/11

1 2 3 4 5 6 7 8 9 10 11 12 13 14 15 16 17 18 19 20 21 22 23 24 25 26 27 28 29

523-2/11









52



XM  
523-2/11b

3

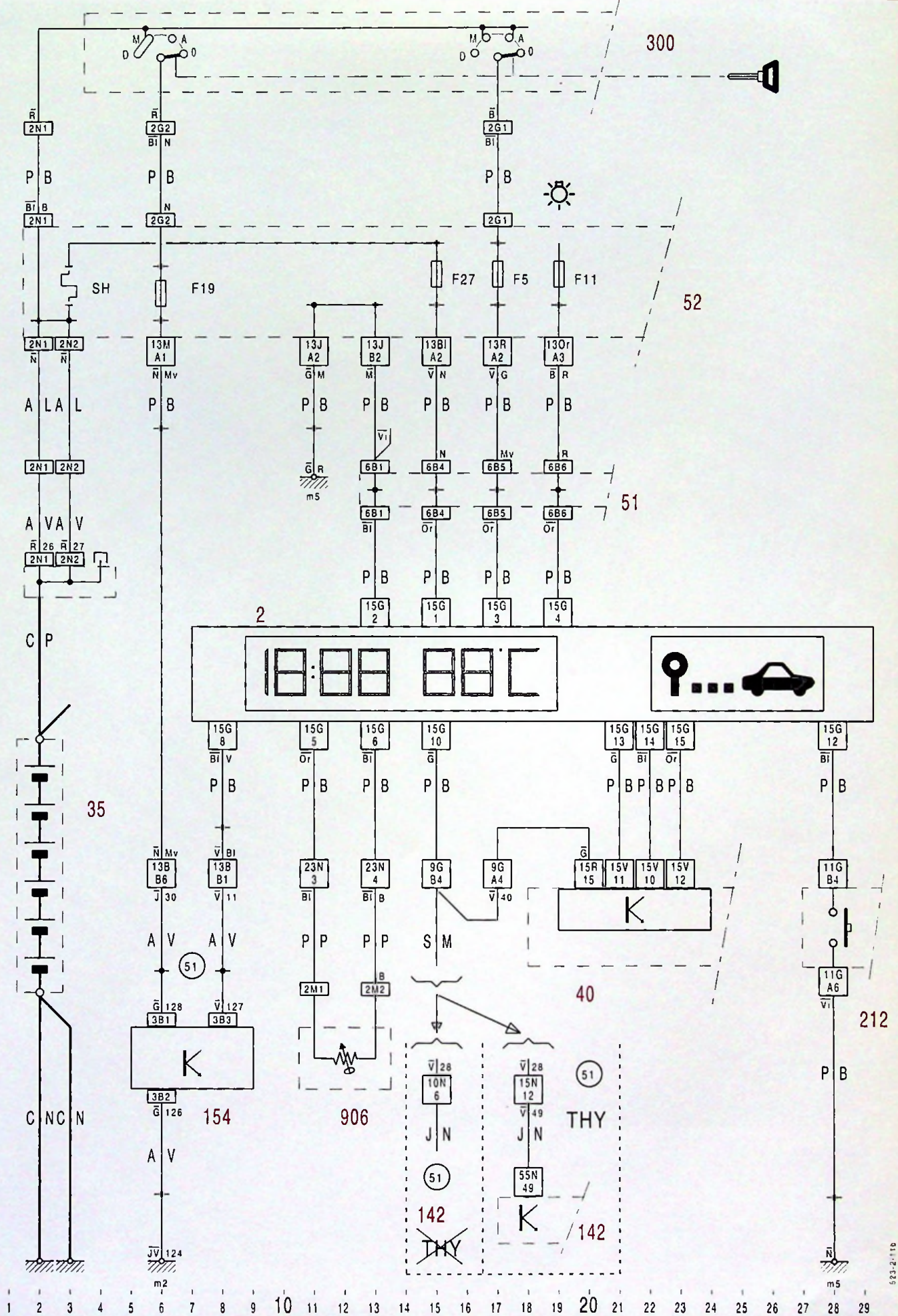





52



XM  
523-2/11c

3

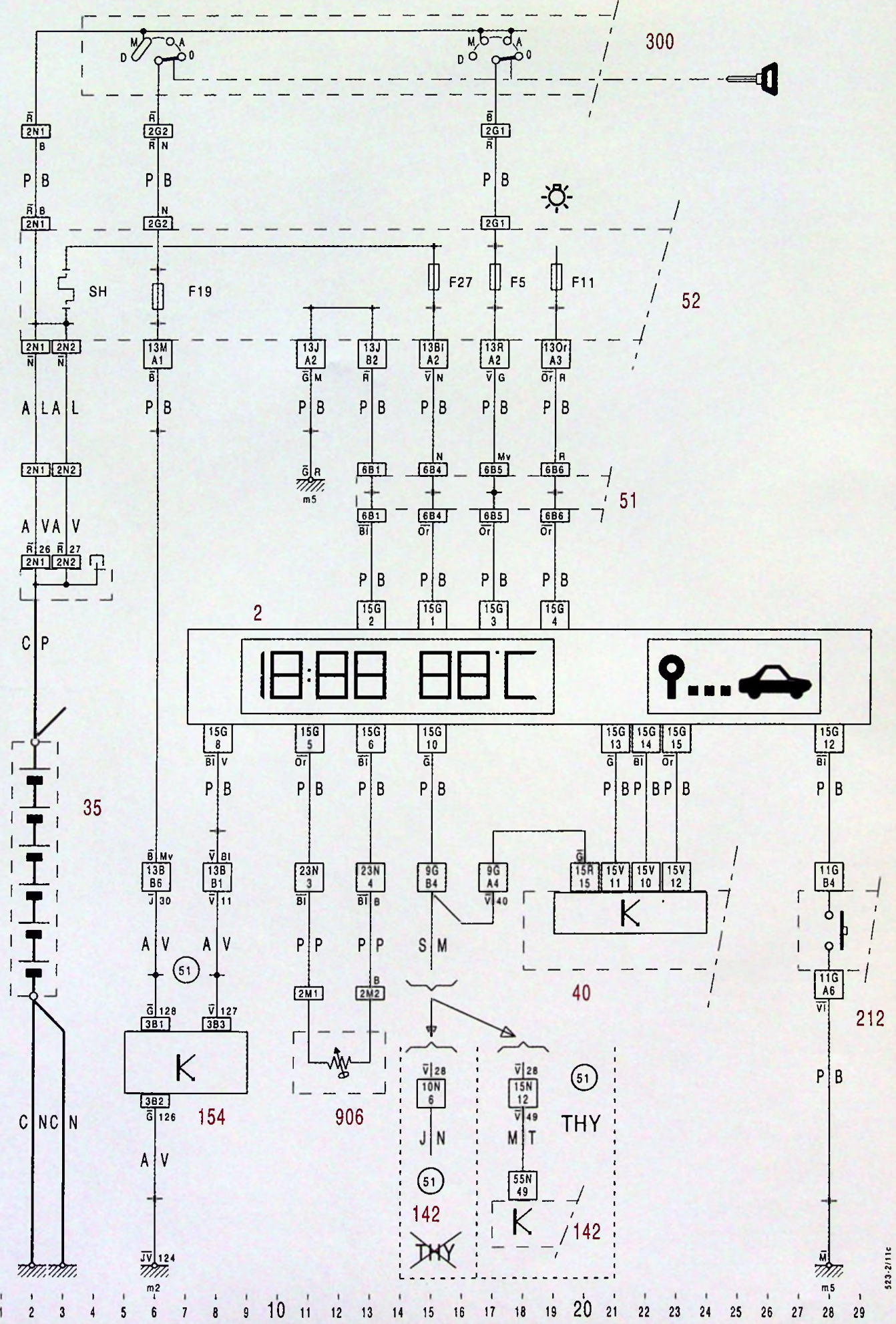





52



XM  
523-2/11d

3

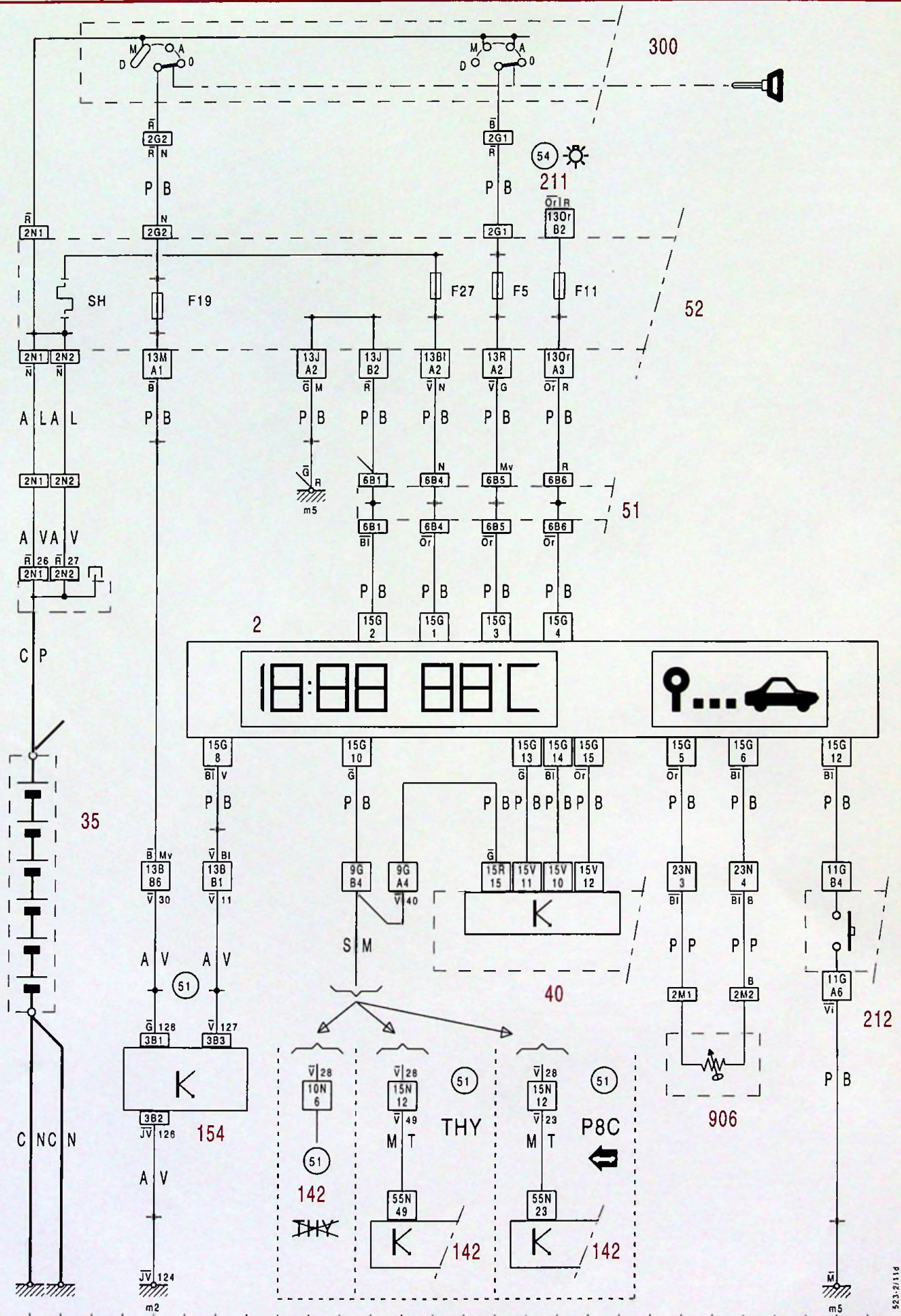

523-2/11d

523-2/11d

1 2 3 4 5 6 7 8 9 10 11 12 13 14 15 16 17 18 19 20 21 22 23 24 25 26 27 28 29





52



XM  
524-0/11

3

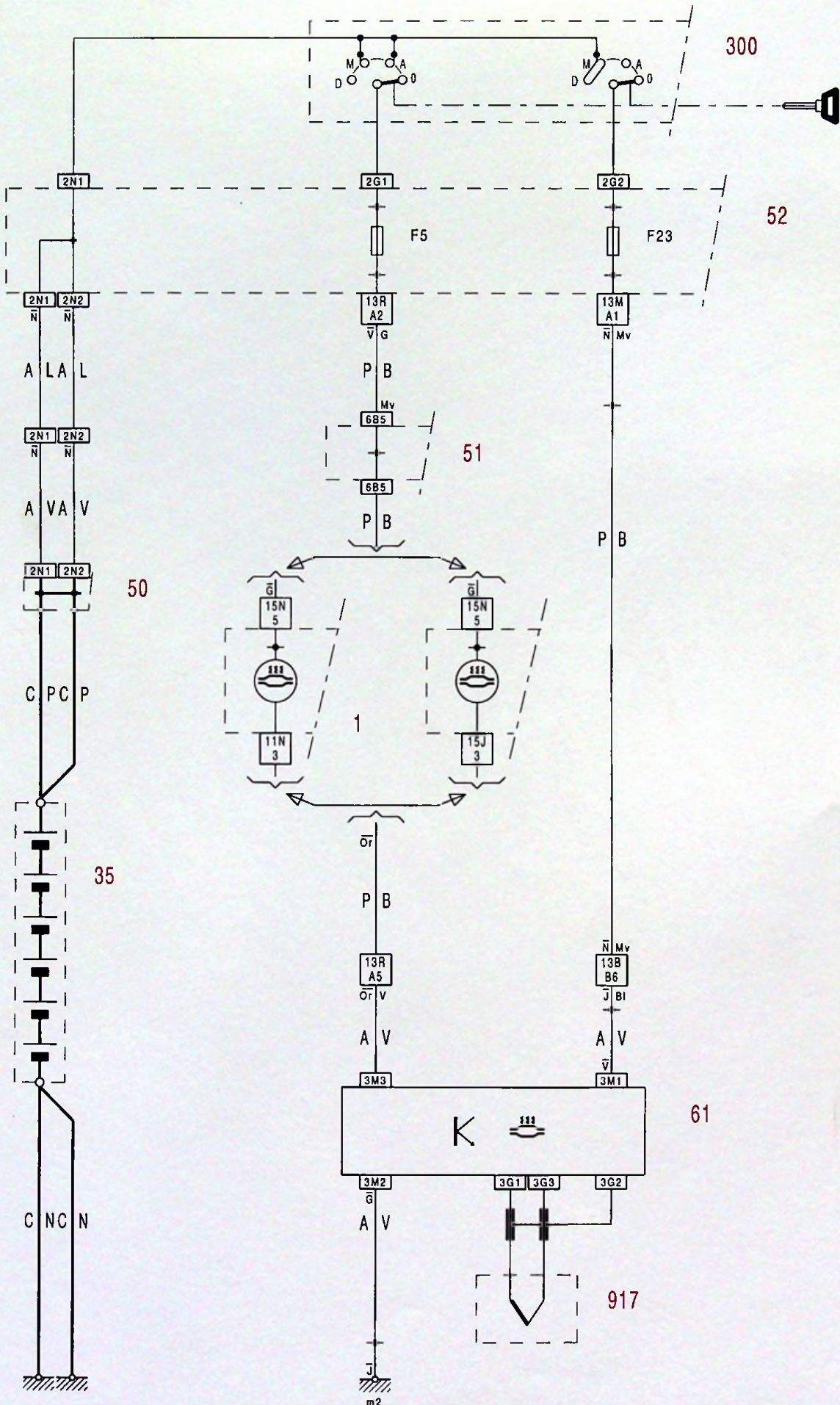

524-0/11

1 2 3 4 5 6 7 8 9 10 11 12 13 14 15 16 17 18 19 20 21 22 23 24 25 26 27 28 29

524-0/11





52



XM  
524-0/11a

3

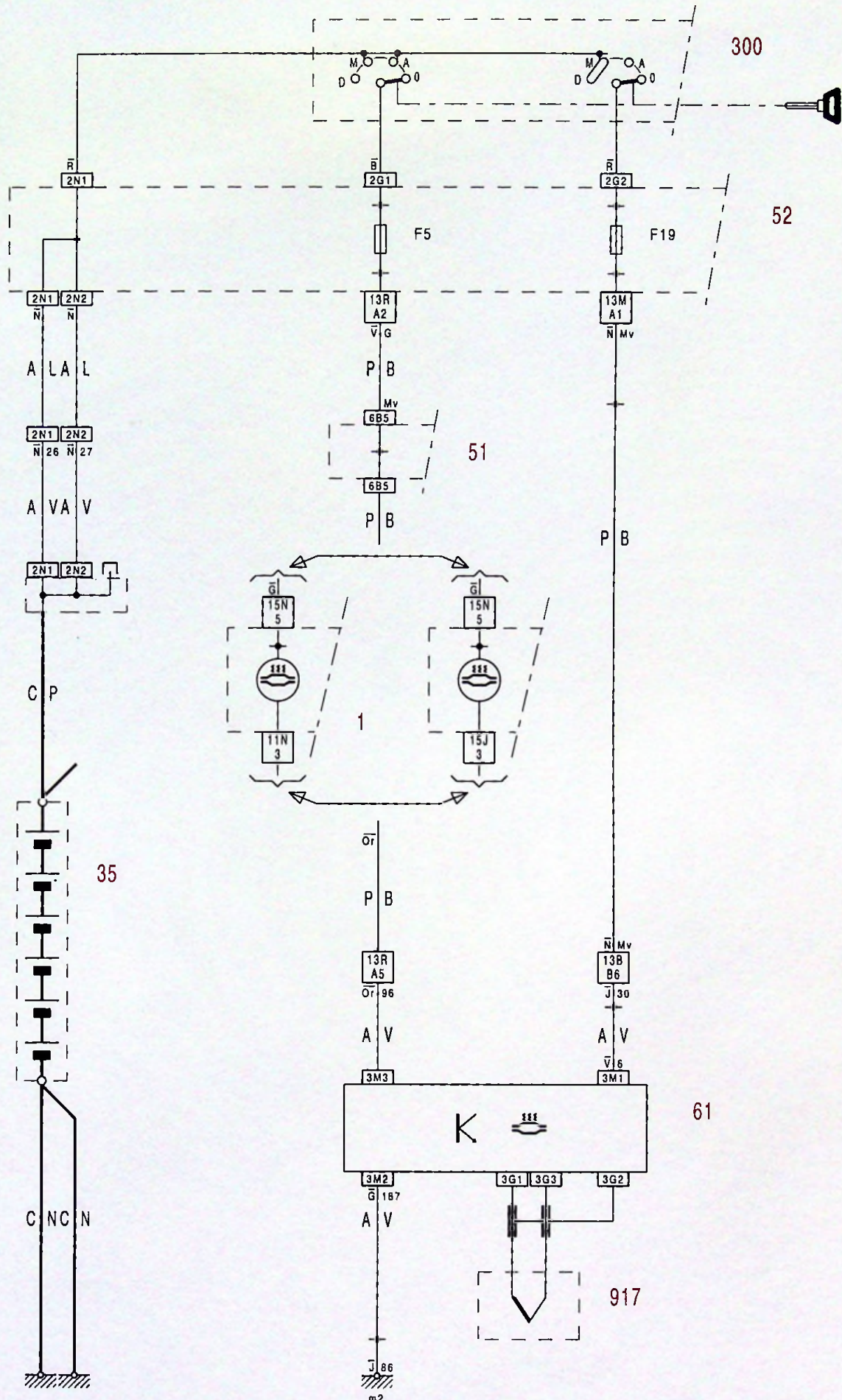

524-0/11a

524-0/11a

1 2 3 4 5 6 7 8 9 10 11 12 13 14 15 16 17 18 19 20 21 22 23 24 25 26 27 28 29





52



XM  
524-0/11b

3

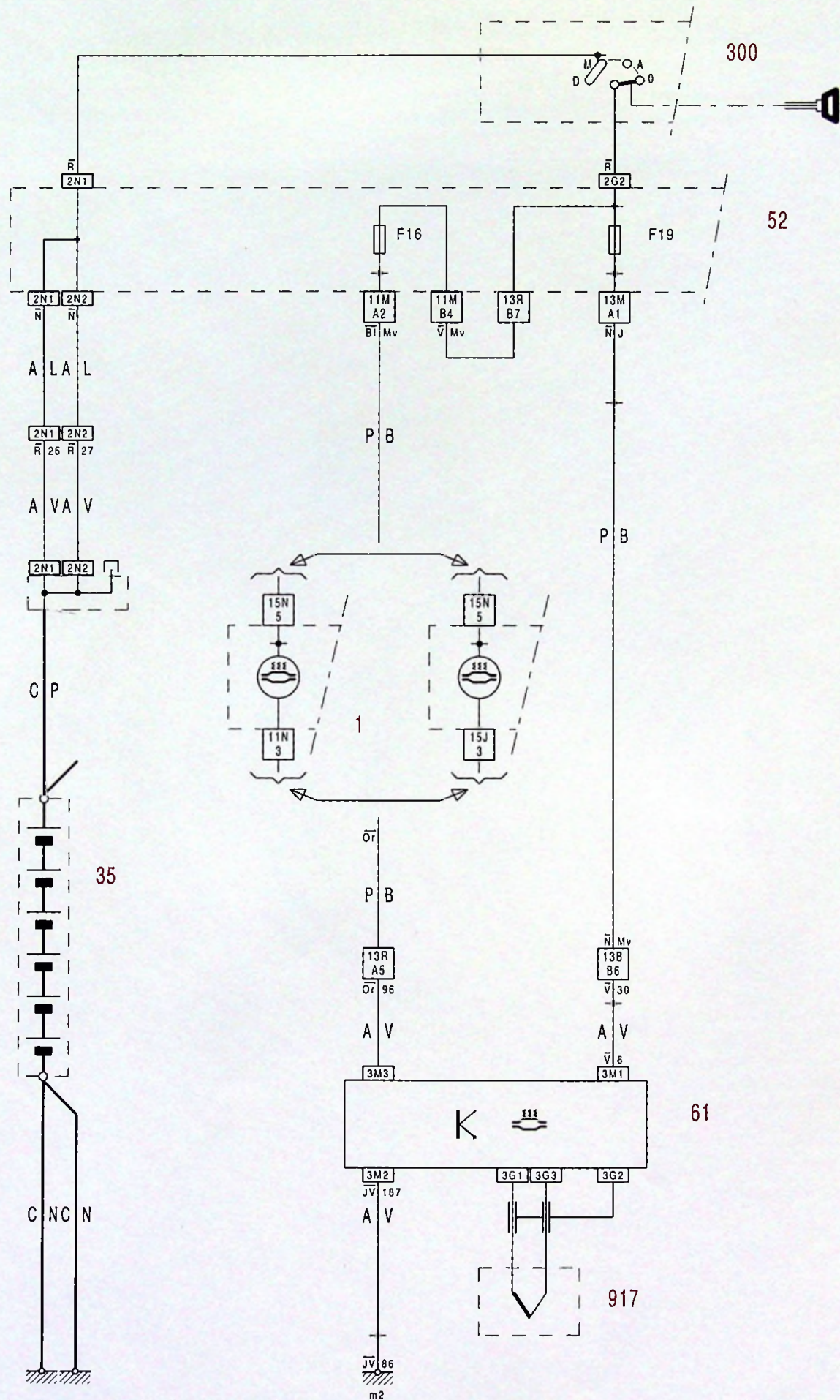

1 2 3 4 5 6 7 8 9 10 11 12 13 14 15 16 17 18 19 20 21 22 23 24 25 26 27 28 29







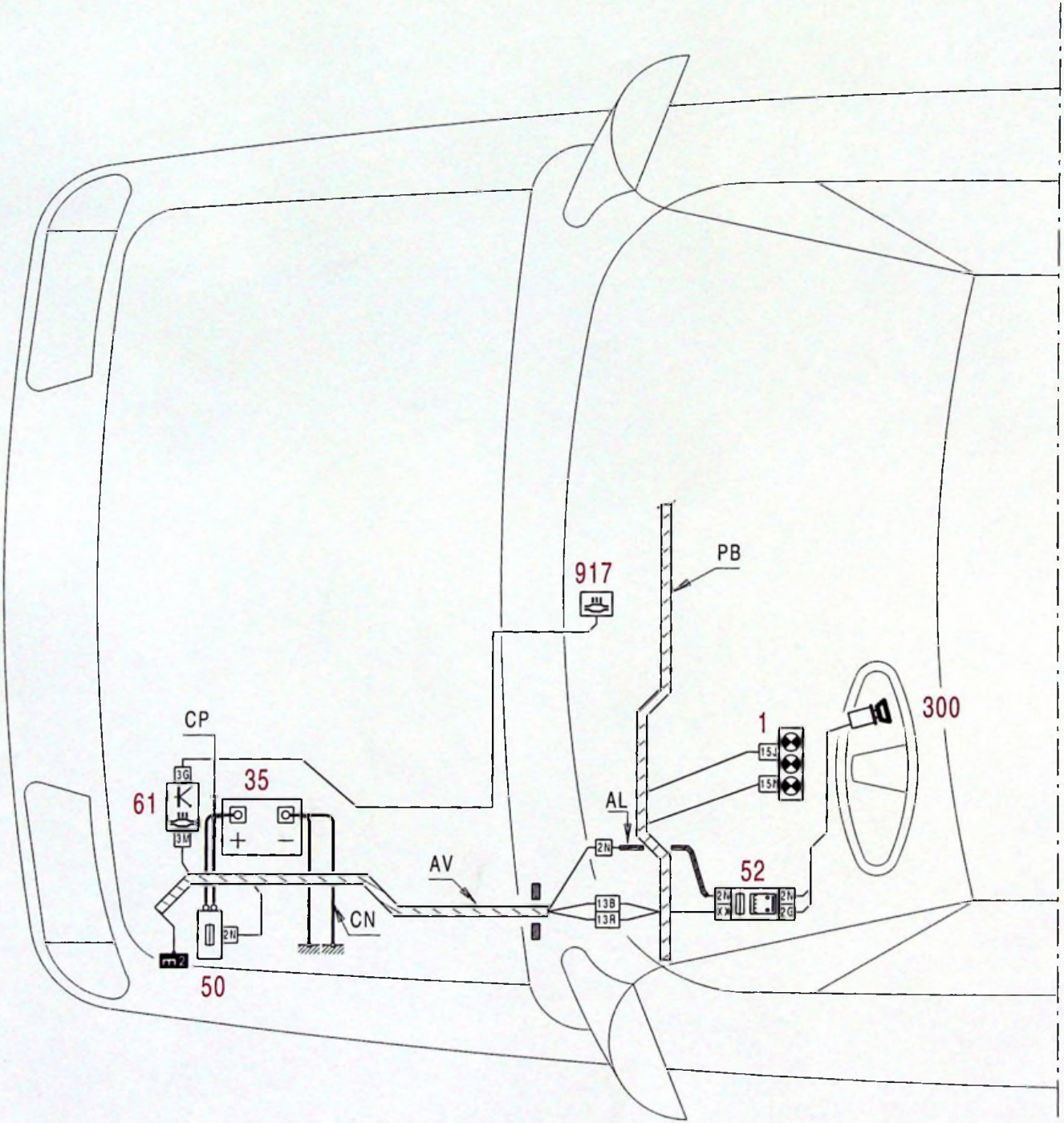





52



XM  
524-0/11d

3

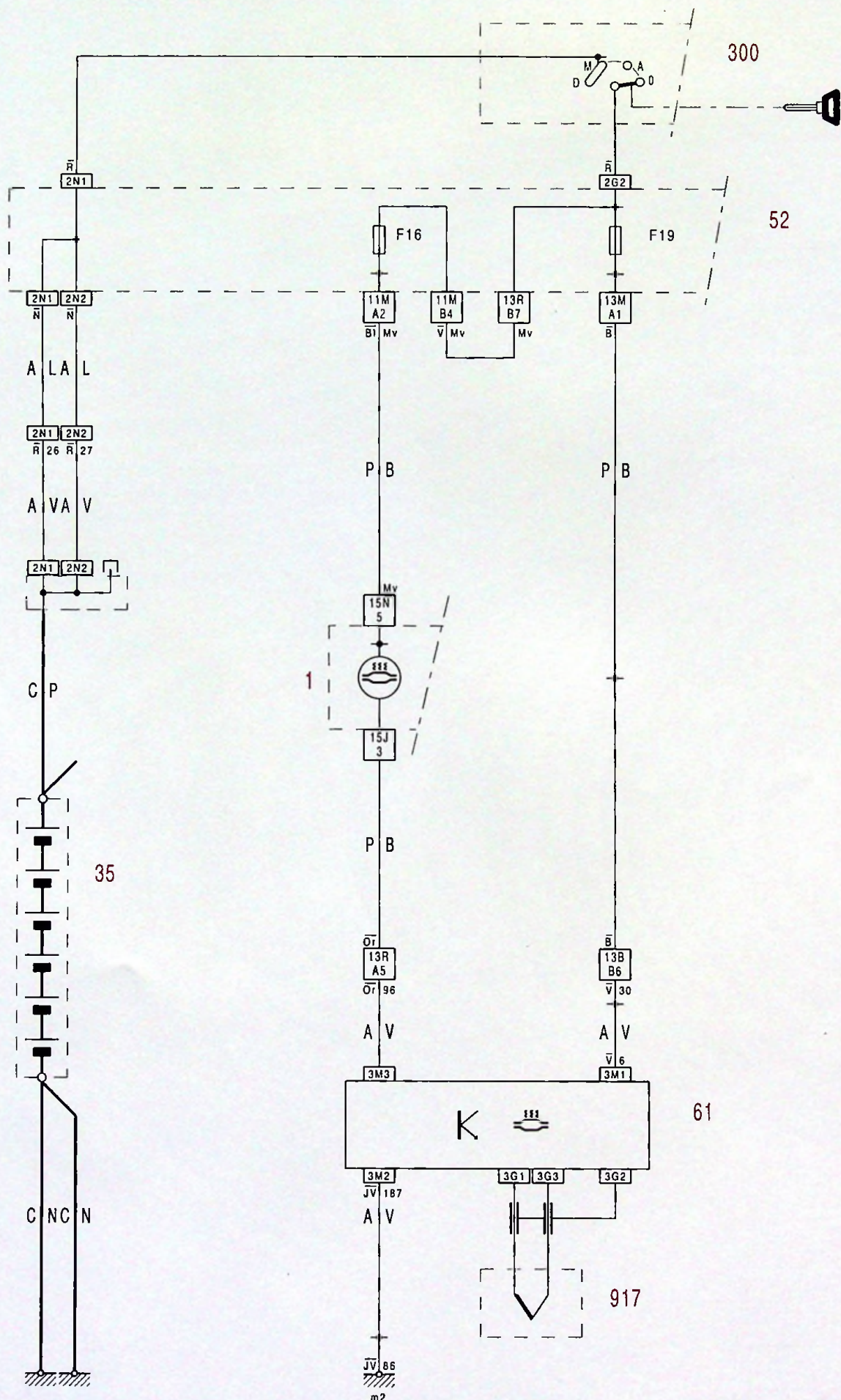

524-0/11d

524-0/11d