

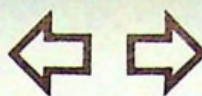

54



XM
540-000/1

1

FONCTION : ECLAIRAGE ET SIGNALISATION

LISTE DES SCHEMAS



ECLAIRAGE EXTERIEUR

NUMERO	DIRECTION	VALIDITE	DESIGNATION
541-00/11	Gauche	03/92 → → 07/93	VEHICULE sans AFFICHEUR GAUCHE Volant bibranche.
541-00/11a	Gauche	07/93 →	Evolution a : Modification interconnexions entre faisceaux PB et AV, évolution faisceaux PB et AV.
541-00/40	Gauche	05/89 → → 03/92	VEHICULE avec MATRICE DE POINTS
541-0/11	Gauche	10/91 → → 07/93	XM BREAK sans MATRICE DE POINTS Véhicule sans option.
541-0/12	Gauche	10/91 → → 07/93	XM BREAK sans MATRICE DE POINTS Véhicule avec option.
541-0/12a	Gauche	07/93 →	Evolution a : Modification interconnexions entre faisceaux PB et AV, évolution faisceaux PB et AV.
541-0/21	Gauche	05/89 → → 03/92	VEHICULE avec SILHOUETTE AUTO
541-0/21a	Gauche	03/92 → → 07/93	Evolution a : Volant bibranche.
541-0/21b	Gauche	07/93 →	Evolution b : Modification interconnexions entre faisceaux PB et AV, évolution faisceaux PB et AV.
541-0/31	Gauche	10/91 → → 07/93	XM BREAK avec MATRICE DE POINTS
541-0/31a	Gauche	07/93 →	Evolution a : Modification interconnexions entre faisceaux PB et AV, évolution faisceaux PB et AV.
541-0/32	Gauche	03/92 → → 07/93	VEHICULE avec MATRICE DE POINTS Moteur 6 cyl. avec régulation de vitesse Volant bibranche.
541-0/32a	Gauche	07/93 →	Evolution a : Modification interconnexions entre faisceaux PB et AV, évolution faisceaux PB et AV.
541-1/21	Gauche	→ 03/92	XM BREAK sans AFFICHEUR GAUCHE (N - S - SF)
541-1/21a	Gauche	03/92 → → 07/93	Evolution a : Volant bibranche.
541-1/21b	Gauche	07/93 →	Evolution b : Modification interconnexions entre faisceaux PB et AV, évolution faisceaux PB et AV.



54



XM
540-000/1

3

ECLAIRAGE EXTERIEUR

NUMERO	DIRECTION	VALIDITE	DESIGNATION
541-1/30	Gauche	→ 03/92	VEHICULE avec SILHOUETTE AUTO (N - S - SF)
541-1/30a	Gauche	03/92 → → 07/93	Evolution a : Volant bibranche.
541-1/30b	Gauche	07/93 →	Evolution b : Modification interconnexions entre faisceaux PB et AV, évolution faisceaux PB et AV.
541-1/31	Gauche	→ 03/92	XM BREAK avec MATRICE DE POINTS (N - S - SF)
541-1/31a	Gauche	03/92 → → 07/93	Evolution a : Volant bibranche.
541-1/31b	Gauche	07/93 →	Evolution b : Modification interconnexions entre faisceaux PB et AV, évolution faisceaux PB et AV.
541-1/40	Gauche	05/89 → → 03/92	VEHICULE avec MATRICE DE POINTS (N - S - SF)
541-1/40a	Gauche	03/92 → → 07/93	Evolution a : Volant bibranche.
541-1/40b	Gauche	07/93 →	Evolution b : Modification interconnexions entre faisceaux PB et AV, évolution faisceaux PB et AV.
541-2/20	Droite	→ 03/92	VEHICULE avec SILHOUETTE AUTO (GB)
541-2/20a	Droite	03/92 → → 07/93	Evolution a : Volant bibranche.
541-2/20b	Droite	07/93 →	Evolution b : Modification interconnexions entre faisceaux PB et AV, évolution faisceaux PB et AV.
541-2/21	Droite	→ 03/92	XM BREAK sans AFFICHEUR GAUCHE (GB)
541-2/21a	Droite	03/92 → → 07/93	Evolution a : Volant bibranche
541-2/21b	Droite	07/93 →	Evolution b : Modification interconnexions entre faisceaux PB et AV, évolution faisceaux PB et AV.



NUMERO	DIRECTION	VALIDITE	DESIGNATION
541-2/30	Droite	01/90 → → 03/92	VEHICULE avec MATRICE DE POINTS (GB) Evolution a : Volant bibranche. Evolution b : Modifications interconnexions entre faisceaux PB et AV, évolution faisceaux PB et AV, suppression du Dim-Dip.
541-2/30a	Droite	03/92 → → 07/93	
541-2/30b	Droite	07/93 →	
541-2/31	Droite	→ 03/92	XM BREAK avec MATRICE DE POINTS (GB) Evolution a : Volant bibranche Evolution b : Modifications interconnexions entre faisceaux PB et AV, évolution faisceaux PB et AV, suppression du Dim-Dip.
541-2/31a	Droite	03/92 → → 07/93	
541-2/31b	Droite	07/93 →	
541-3/20	Droite	01/90 → → 07/93	VEHICULE avec SILHOUETTE AUTO (Sauf GB) Evolution a : Voir 541-2/20b
541-3/20a	Droite	07/93 →	
541-3/30	Droite	01/90 → → 07/93	VEHICULE avec MATRICE DE POINTS (Sauf GB) Evolution a : Voir 541-2/30b
541-3/30a	Droite	07/93 →	

SIGNALISATION EXTERIEURE

(Indicateurs de direction - Avertisseurs - Feux de recul)

NUMERO	DIRECTION	VALIDITE	DESIGNATION
542-00/10	Gauche	05/89 → → 07/93	XM TT Evolution a : Modif. masses des faisceaux PJ et AV.
542-00/10a	Gauche	07/93 →	
542-0/11	Gauche	10/91 →	XM BREAK BVM
542-0/31	Gauche	10/91 →	XM BREAK BVA



54

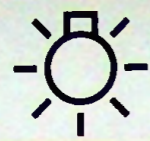

XM
541-00/11

6

7

XM
541-00/11

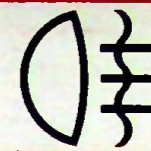

54

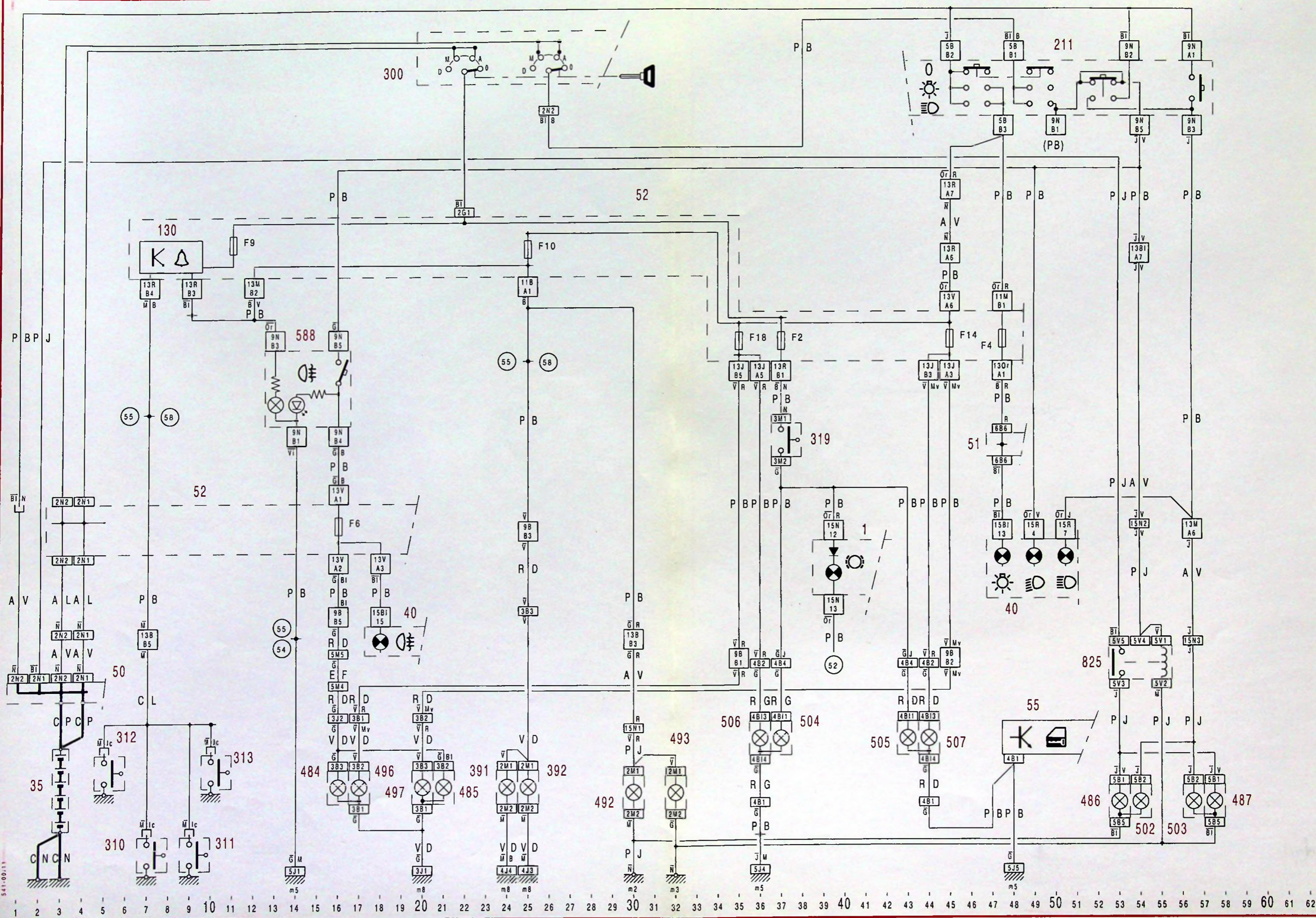



54

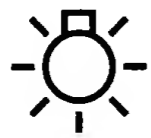

XM
541-00/11a

6

7

XM
541-00/11a



54

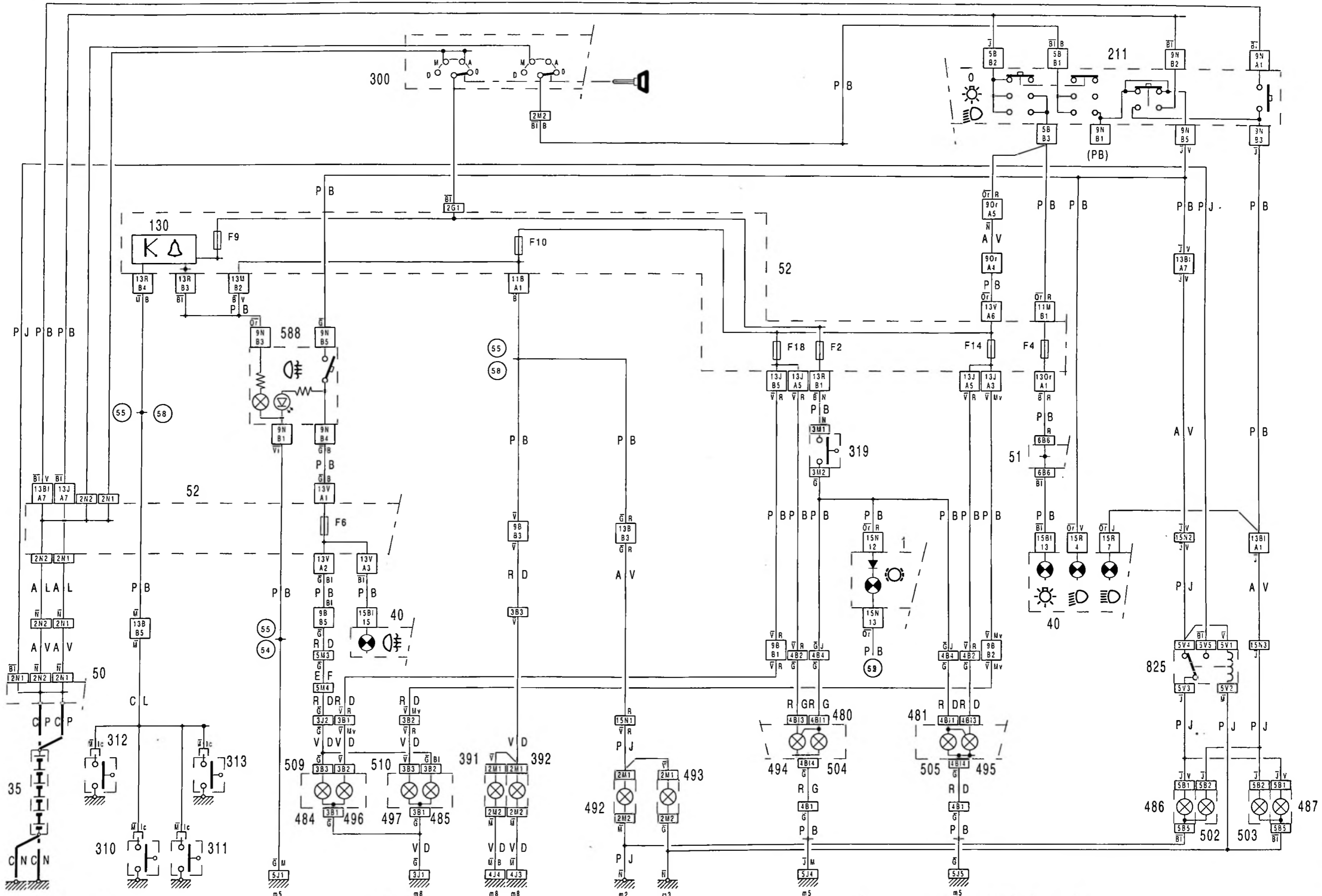

541-00/11a

541-00/11a

1 2 3 4 5 6 7 8 9 10 11 12 13 14 15 16 17 18 19 20 21 22 23 24 25 26 27 28 29 30 31 32 33 34 35 36 37 38 39 40 41 42 43 44 45 46 47 48 49 50 51 52 53 54 55 56 57 58 59 60 61 62



54

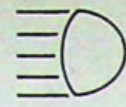

XM
541-00/40

3

4

XM
541-00/40

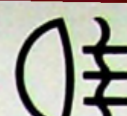
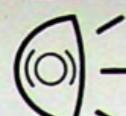

54

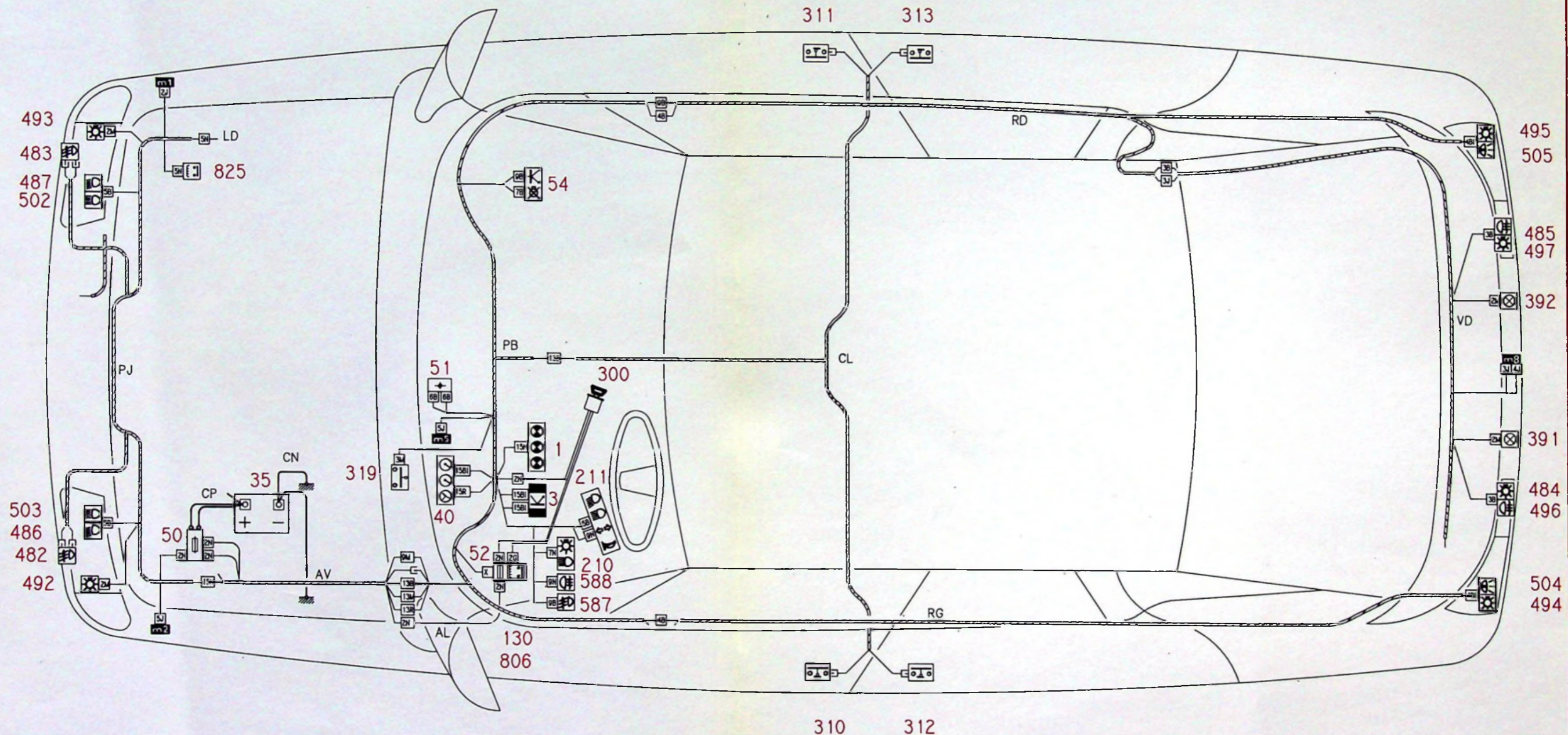



54

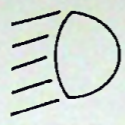
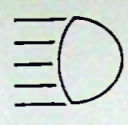

XM
541-00/40

6

7

XM
541-00/40

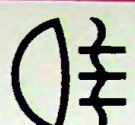

54

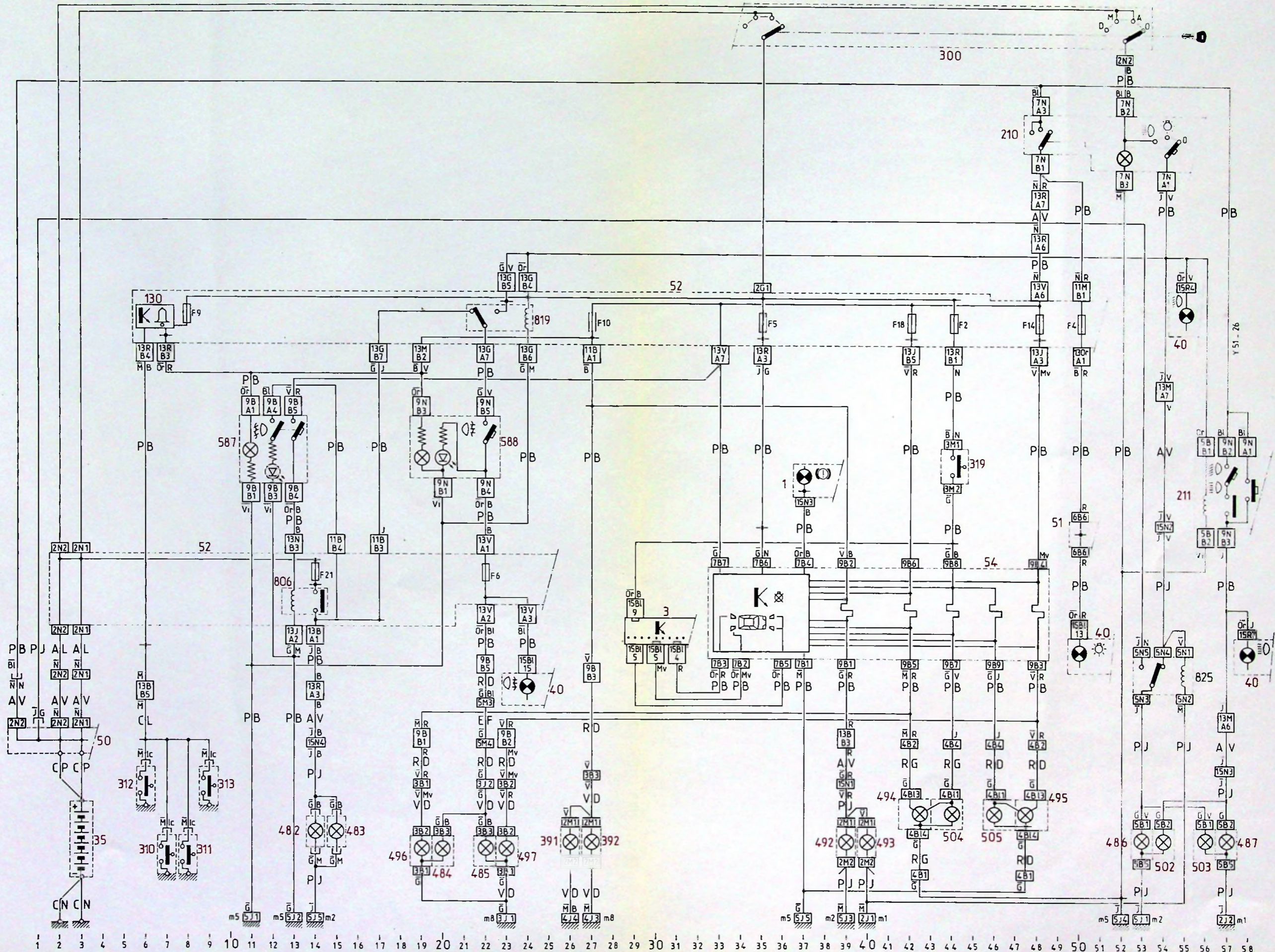



54



XM
541-0/11

3

4

XM
541-0/11



54

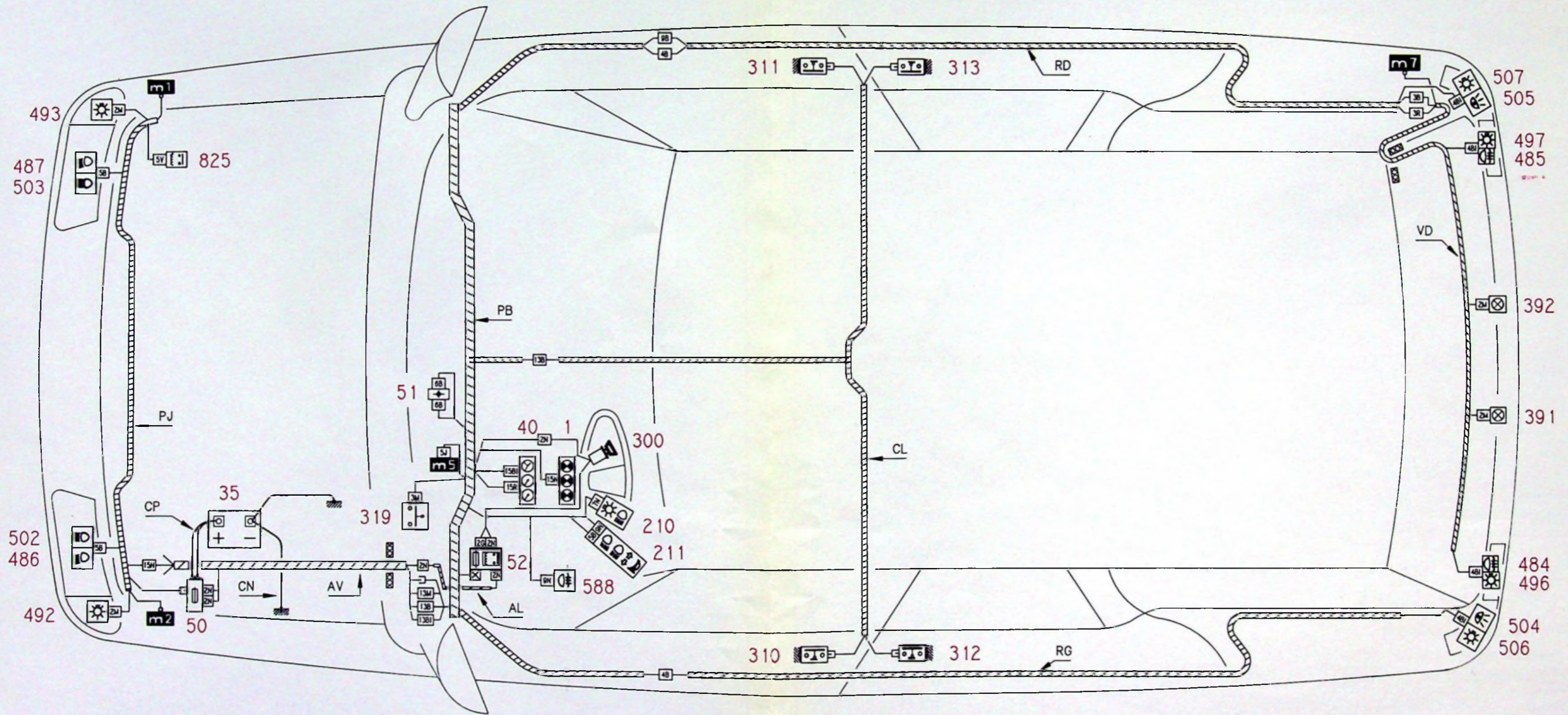



54



XM
541-0/11

6

7

XM
541-0/11

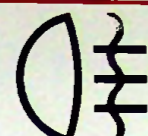
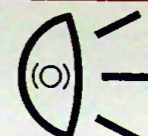

54

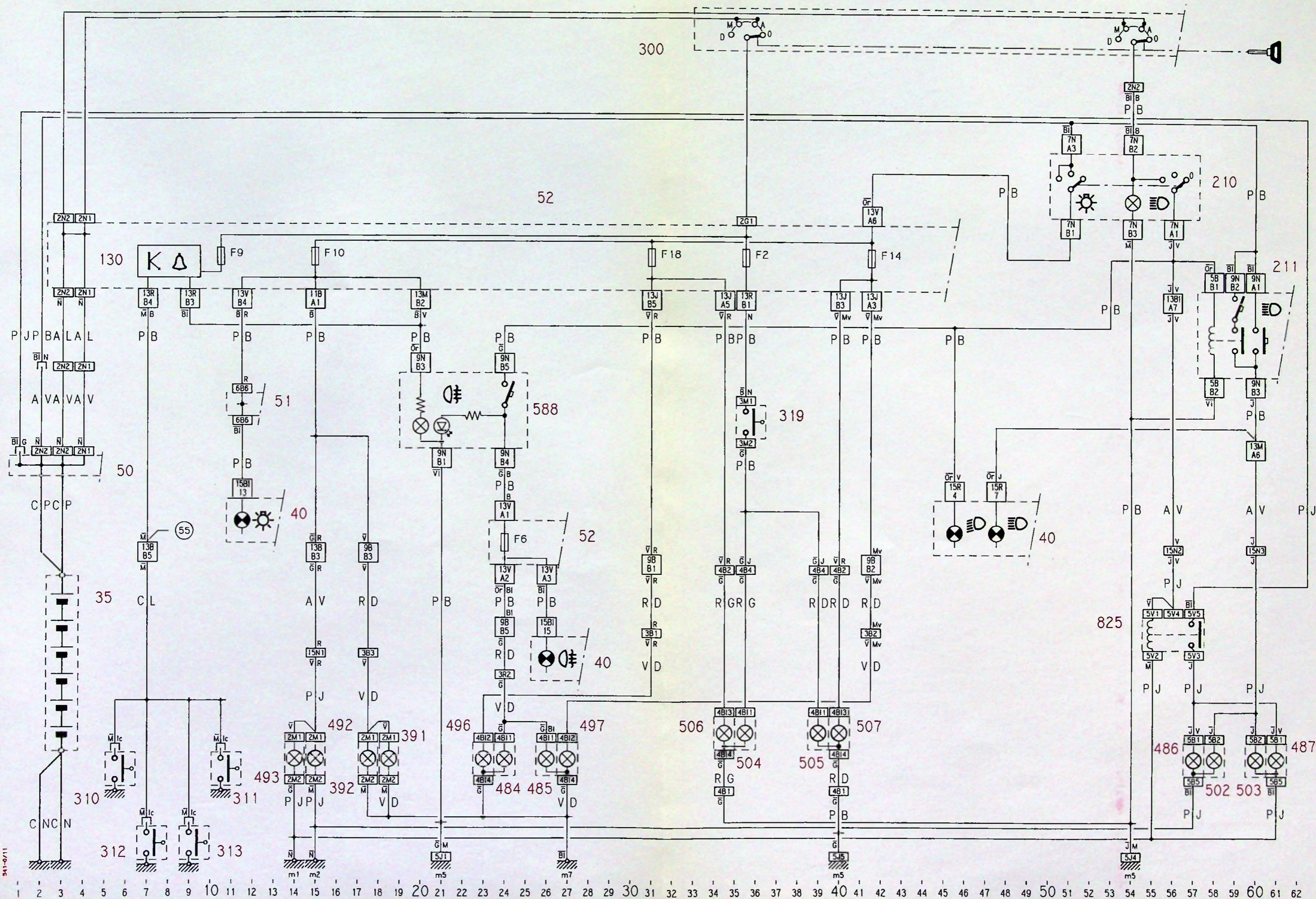



54



XM
541-0/12

6

7

XM
541-0/12

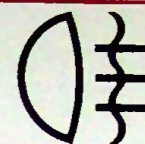
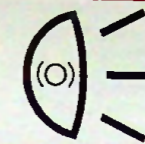

54

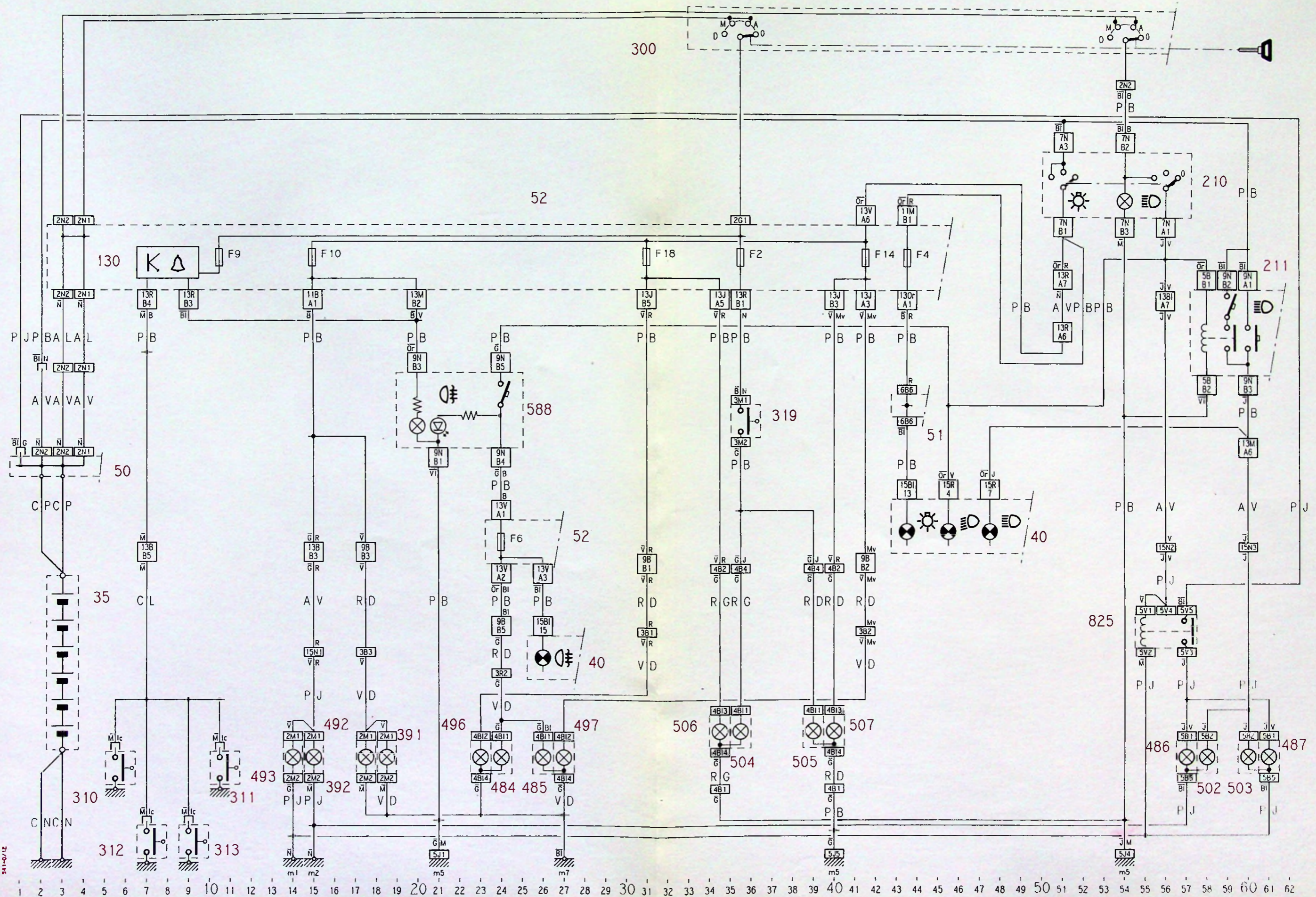



54



XM
541-0/12a

6

7

XM
541-0/12a

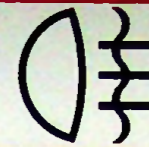
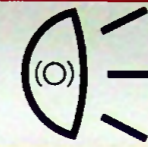

54

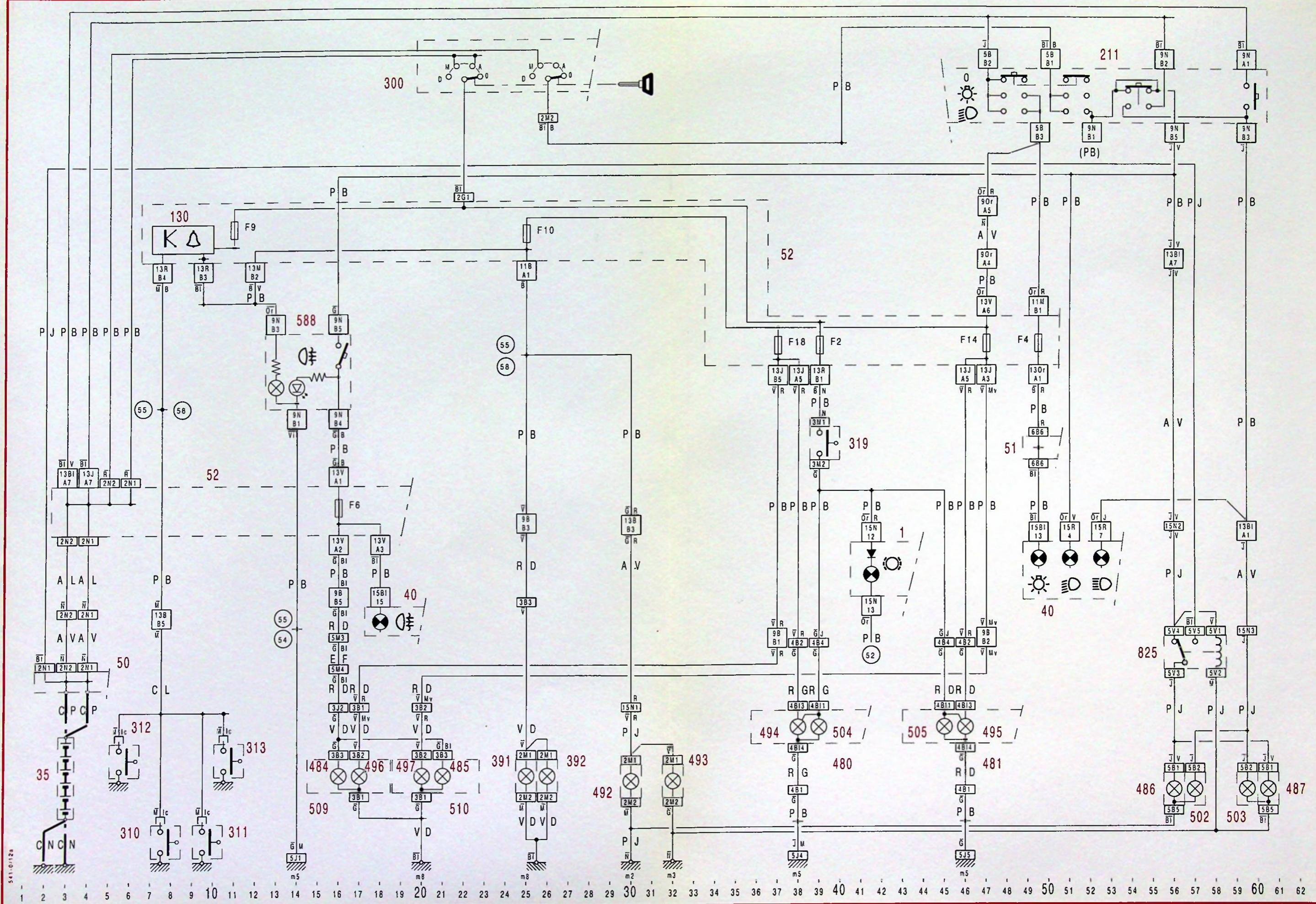

541-0/12a

541-0/12a



54

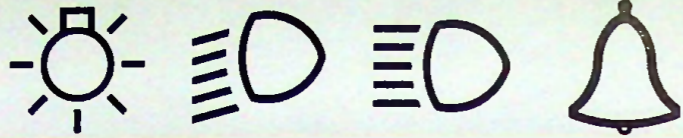

XM
541-0/21a

6

7

XM
541-0/21a

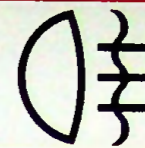
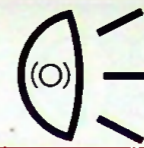

54

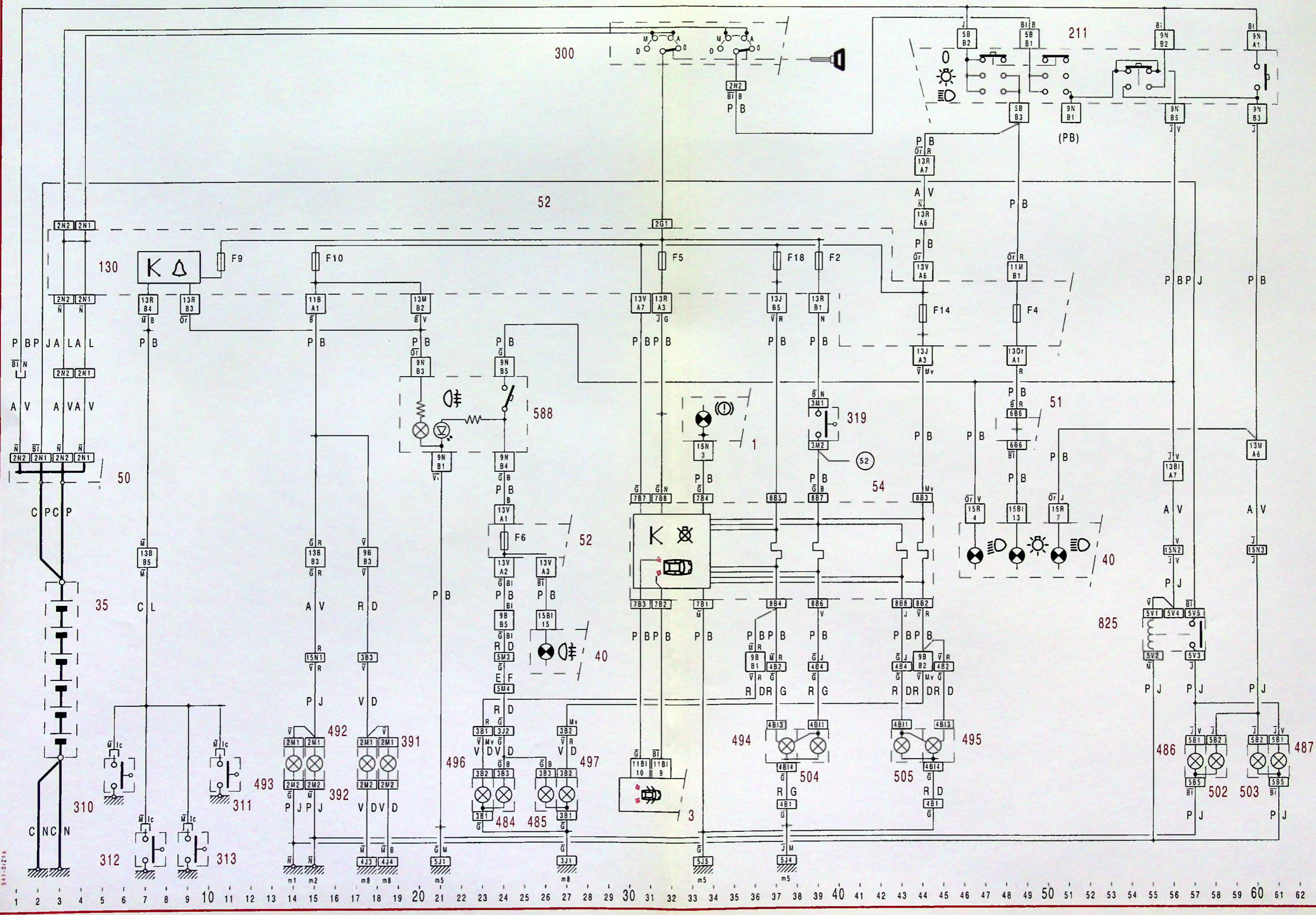



54



XM
541-0/21b

6

7

XM
541-0/21b

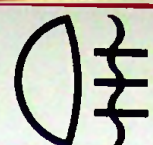
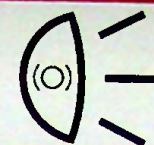

54

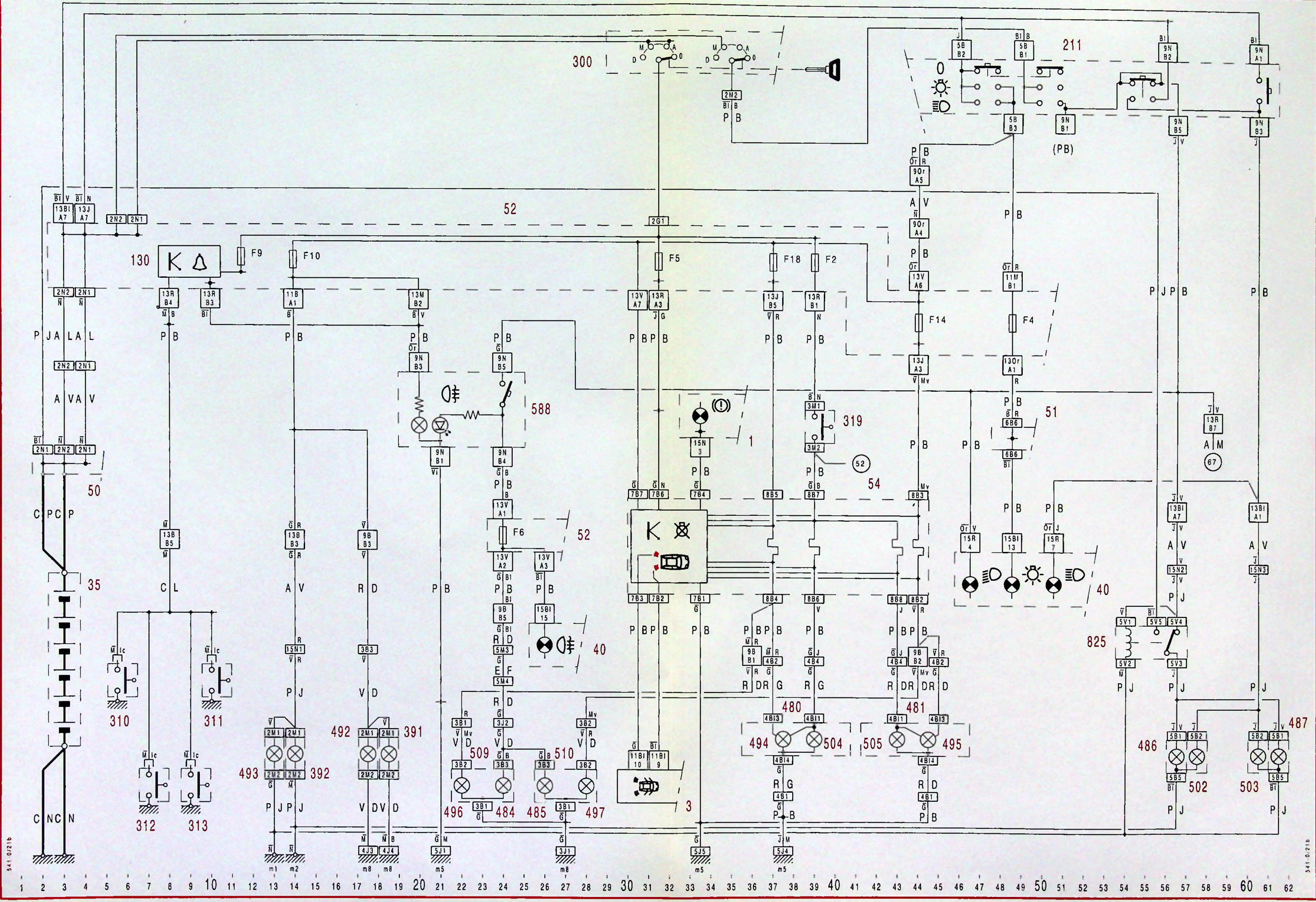

541-0/21b

541-0/21b



54

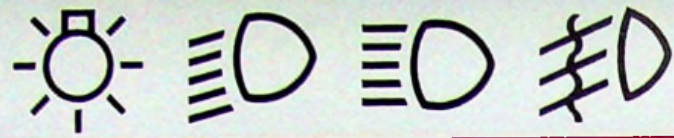

XM
541-0/31

3

4

XM
541-0/31



54

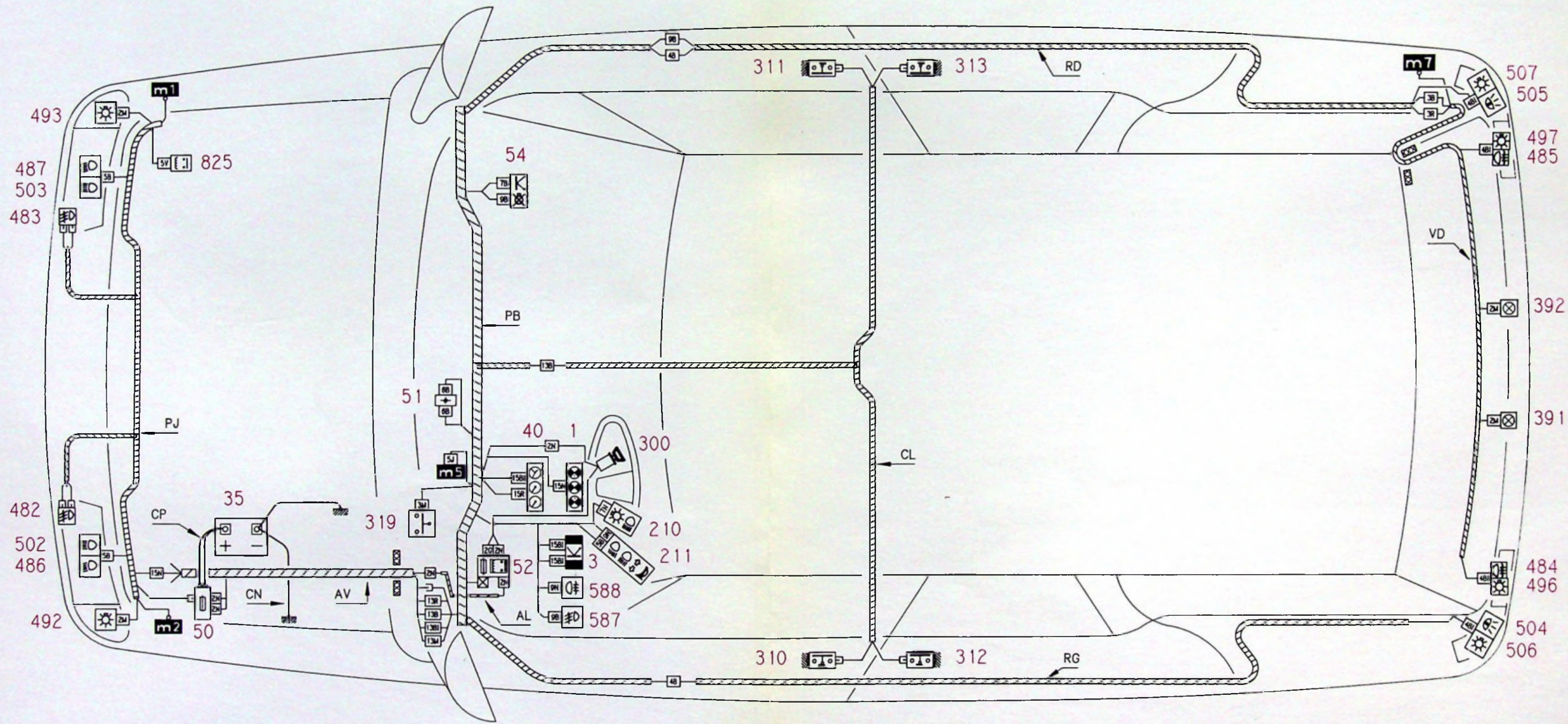



54

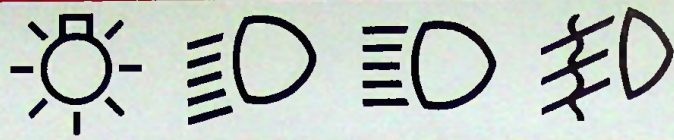

XM
541-0/31

6

7

XM
541-0/31

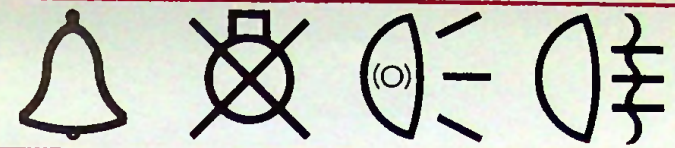

54

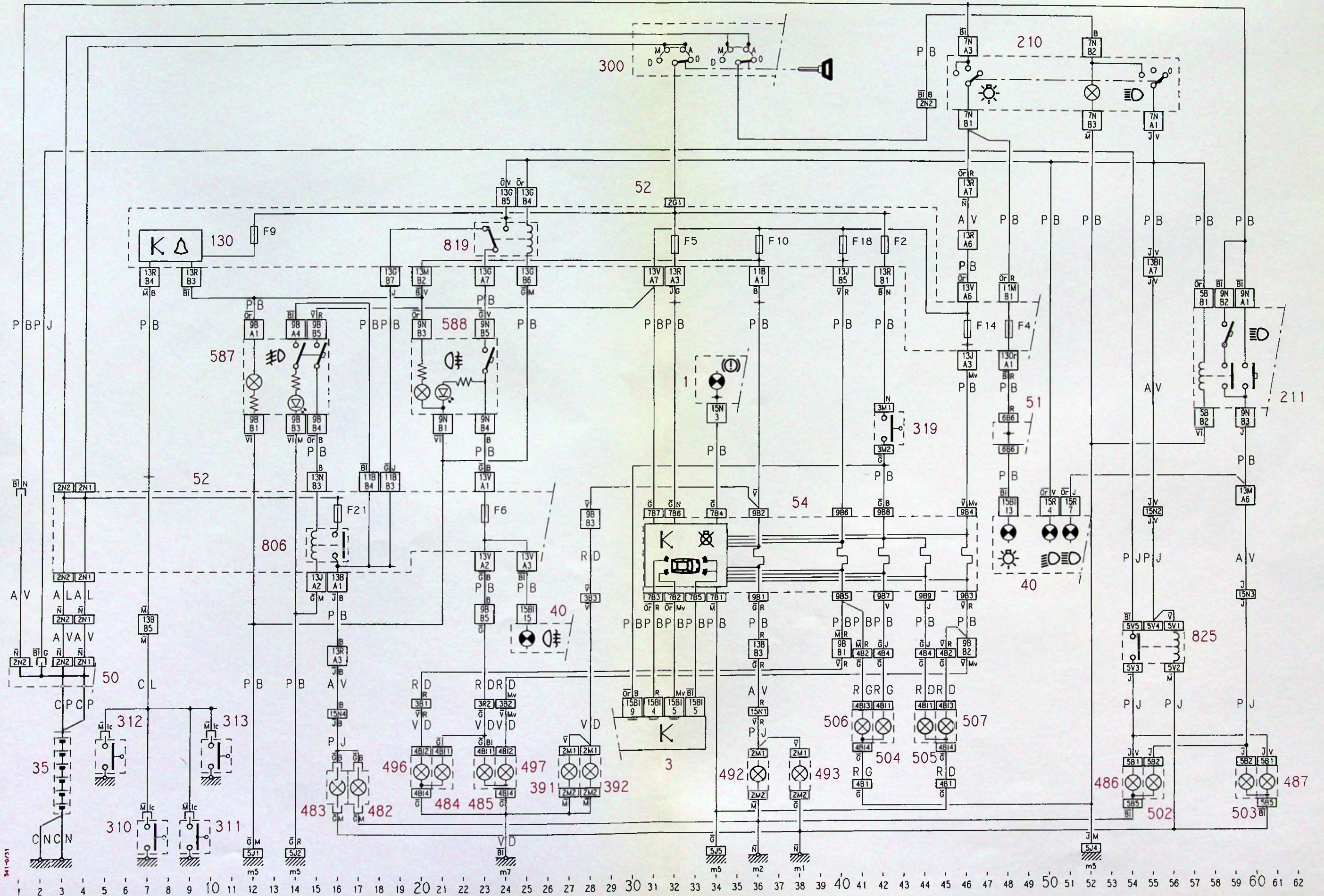



54

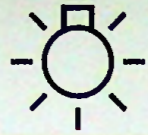

XM
541-0/31a

6

7

XM
541-0/31a

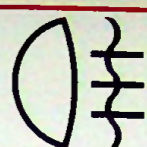
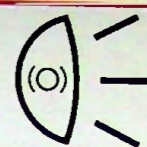

54

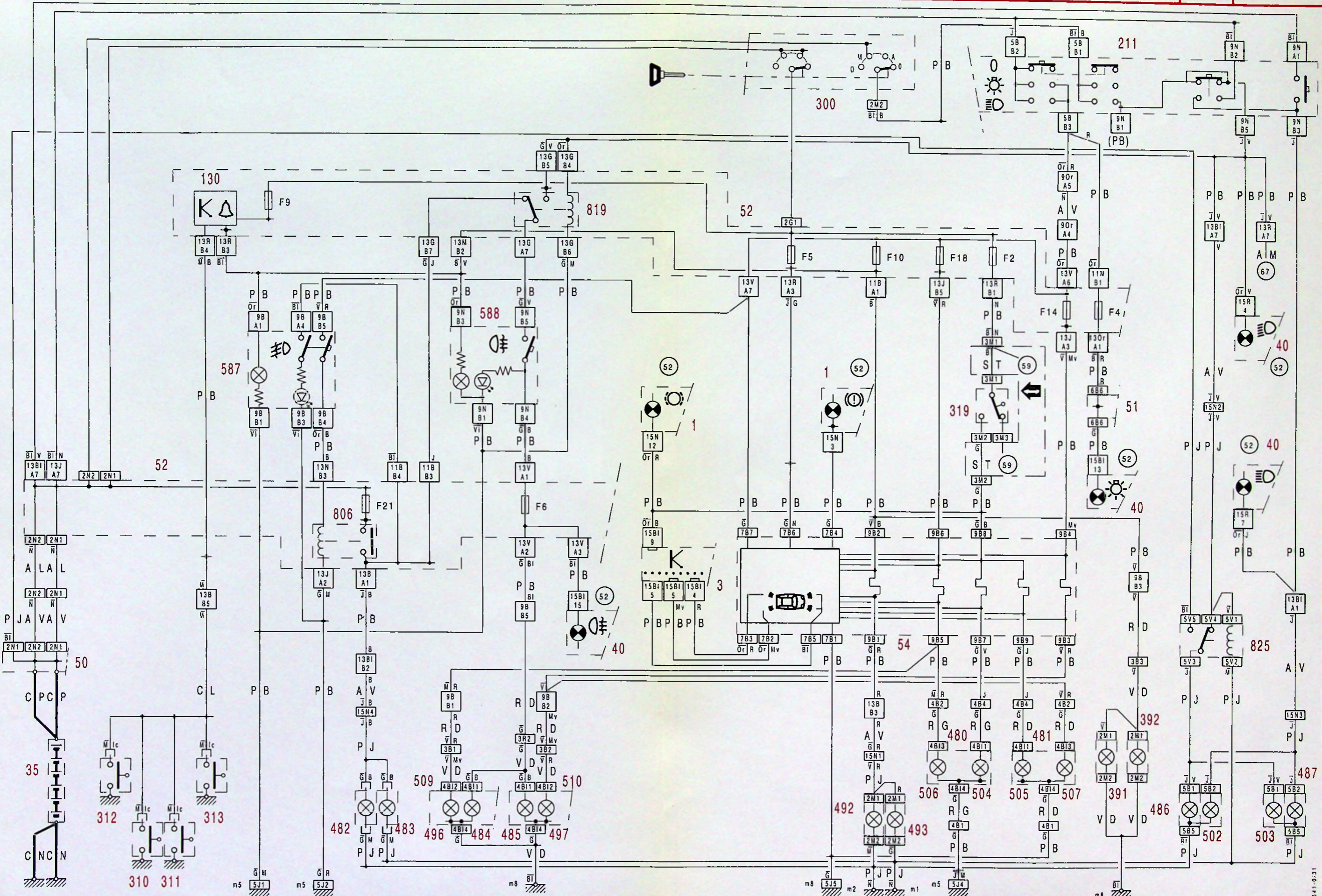

541-0/31

1 2 3 4 5 6 7 8 9 10 11 12 13 14 15 16 17 18 19 20 21 22 23 24 25 26 27 28 29 30 31 32 33 34 35 36 37 38 39 40 41 42 43 44 45 46 47 48 49 50 51 52 53 54 55 56 57 58 59 60 61 62

541-0/31



54

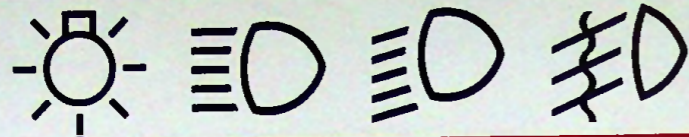

XM
541-0/32

6

7

XM
541-0/32



54

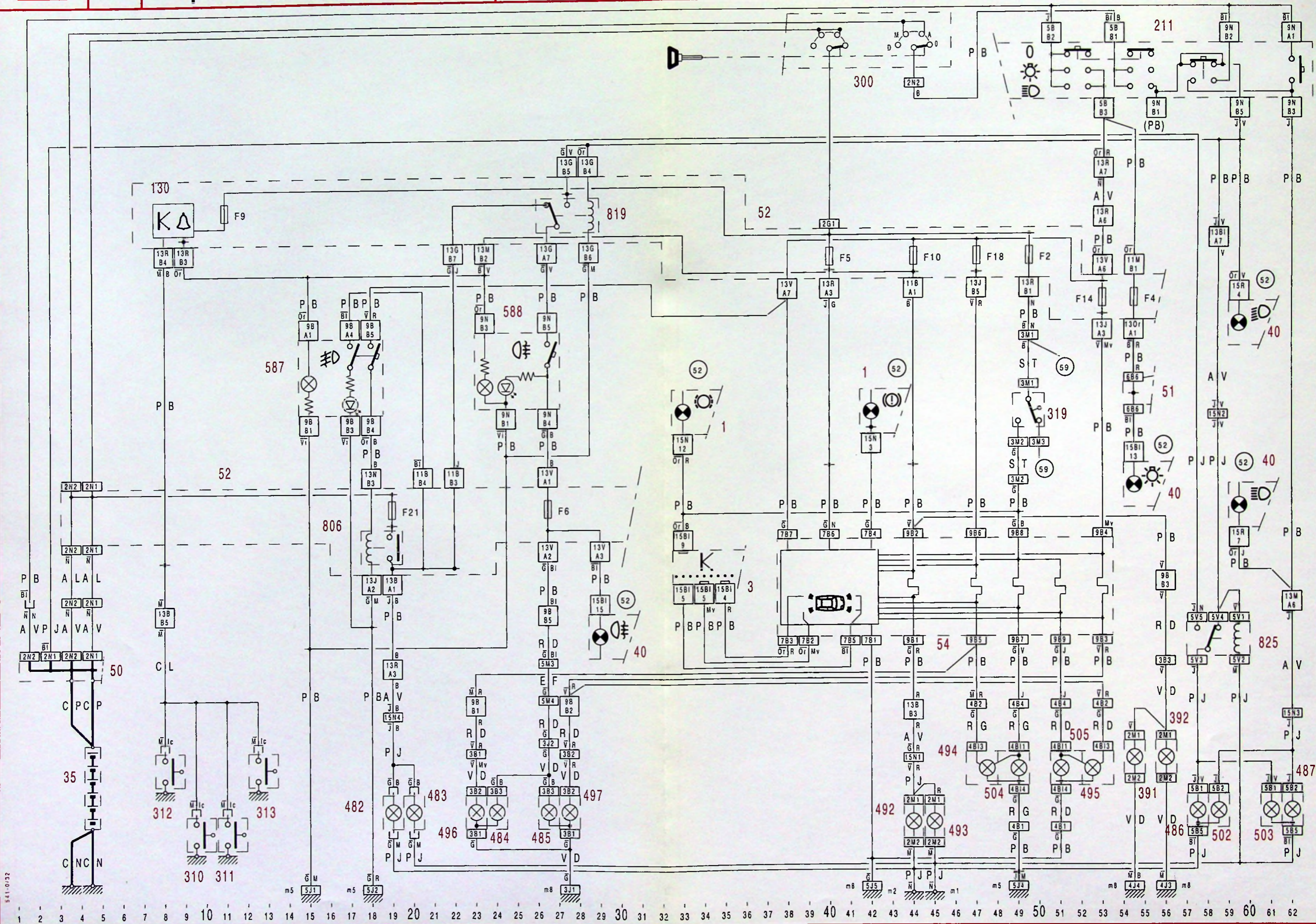

541-0/32

1 2 3 4 5 6 7 8 9 10 11 12 13 14 15 16 17 18 19 20 21 22 23 24 25 26 27 28 29 30 31 32 33 34 35 36 37 38 39 40 41 42 43 44 45 46 47 48 49 50 51 52 53 54 55 56 57 58 59 60 61 62



54

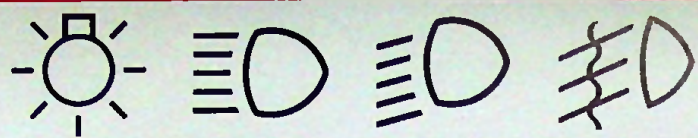

XM
541-0/32a

6

7

XM
541-0/32a

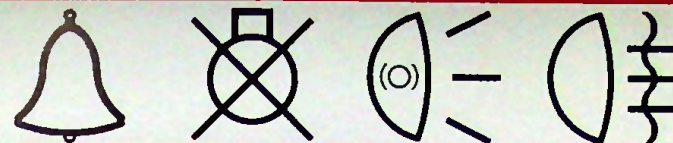

54

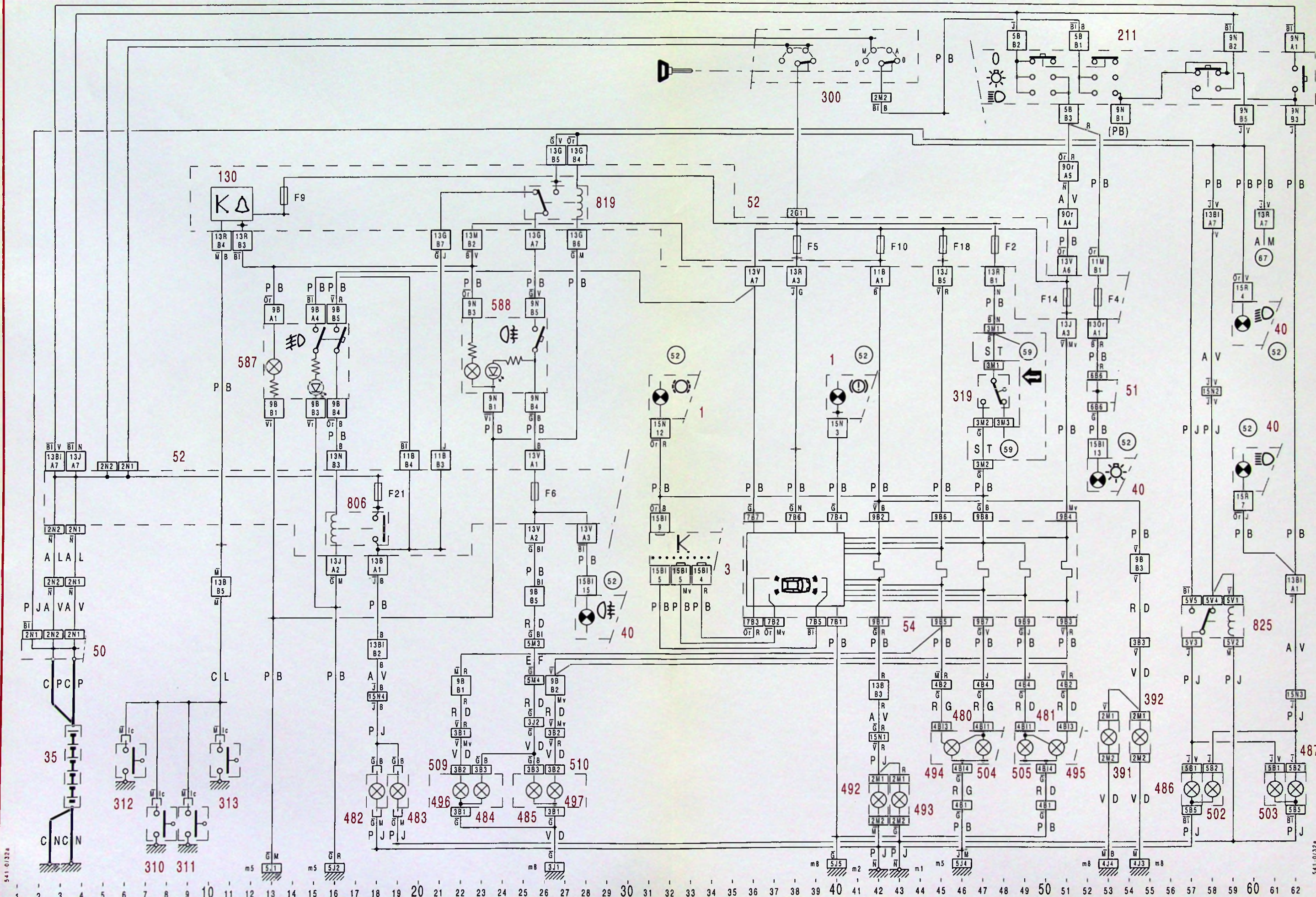

541-0/32a

541-0/32a



54



XM
541-1/21

6

7

XM
541-1/21

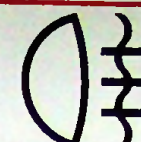
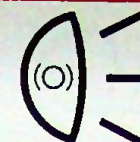
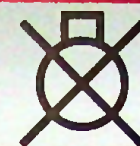

54

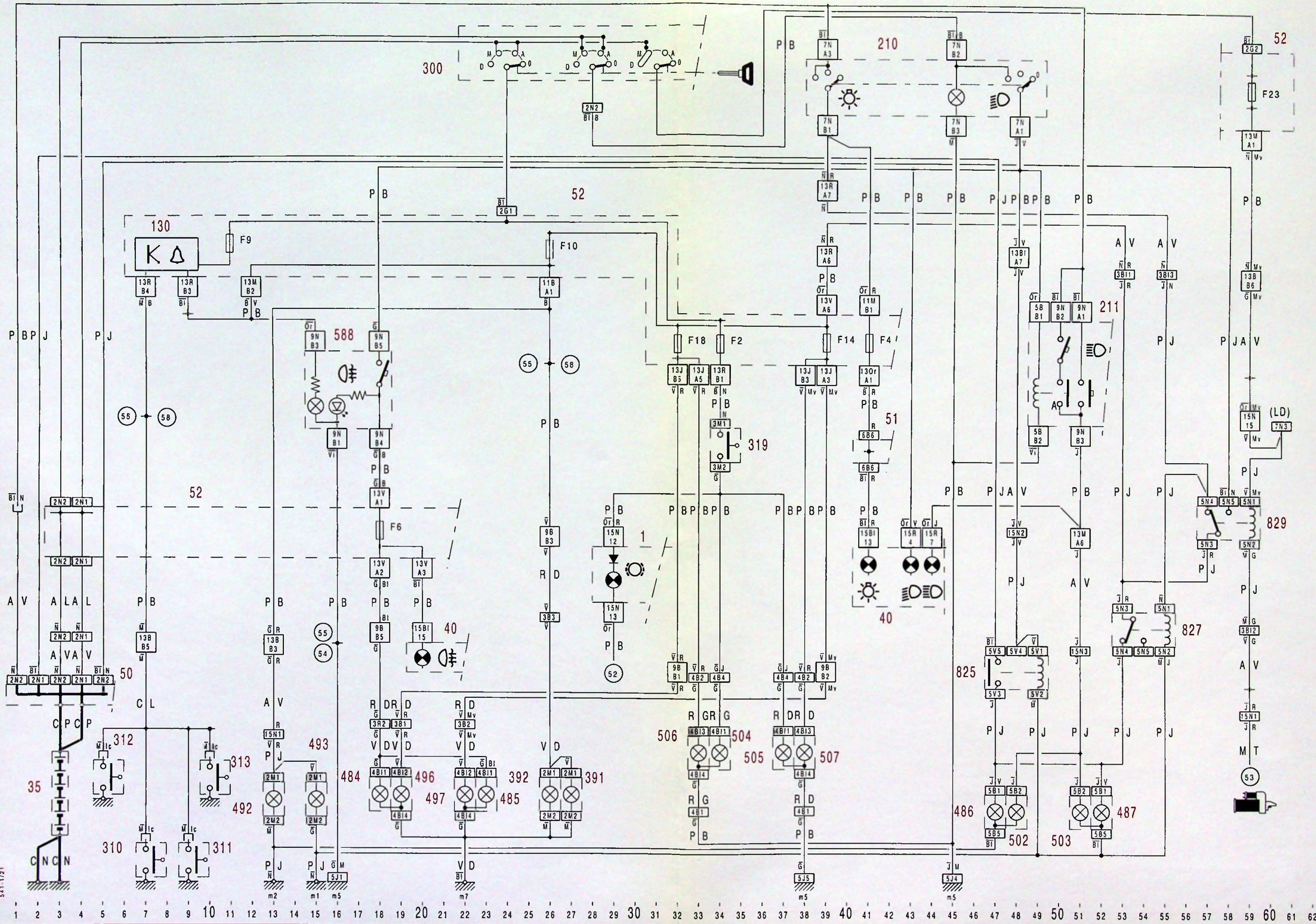

541-1/21

1 2 3 4 5 6 7 8 9 10 11 12 13 14 15 16 17 18 19 20 21 22 23 24 25 26 27 28 29 30 31 32 33 34 35 36 37 38 39 40 41 42 43 44 45 46 47 48 49 50 51 52 53 54 55 56 57 58 59 60 61 62



54



XM
541-1/21a

6

7

XM
541-1/21a

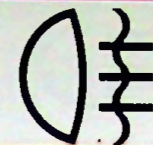
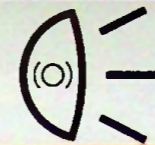

54

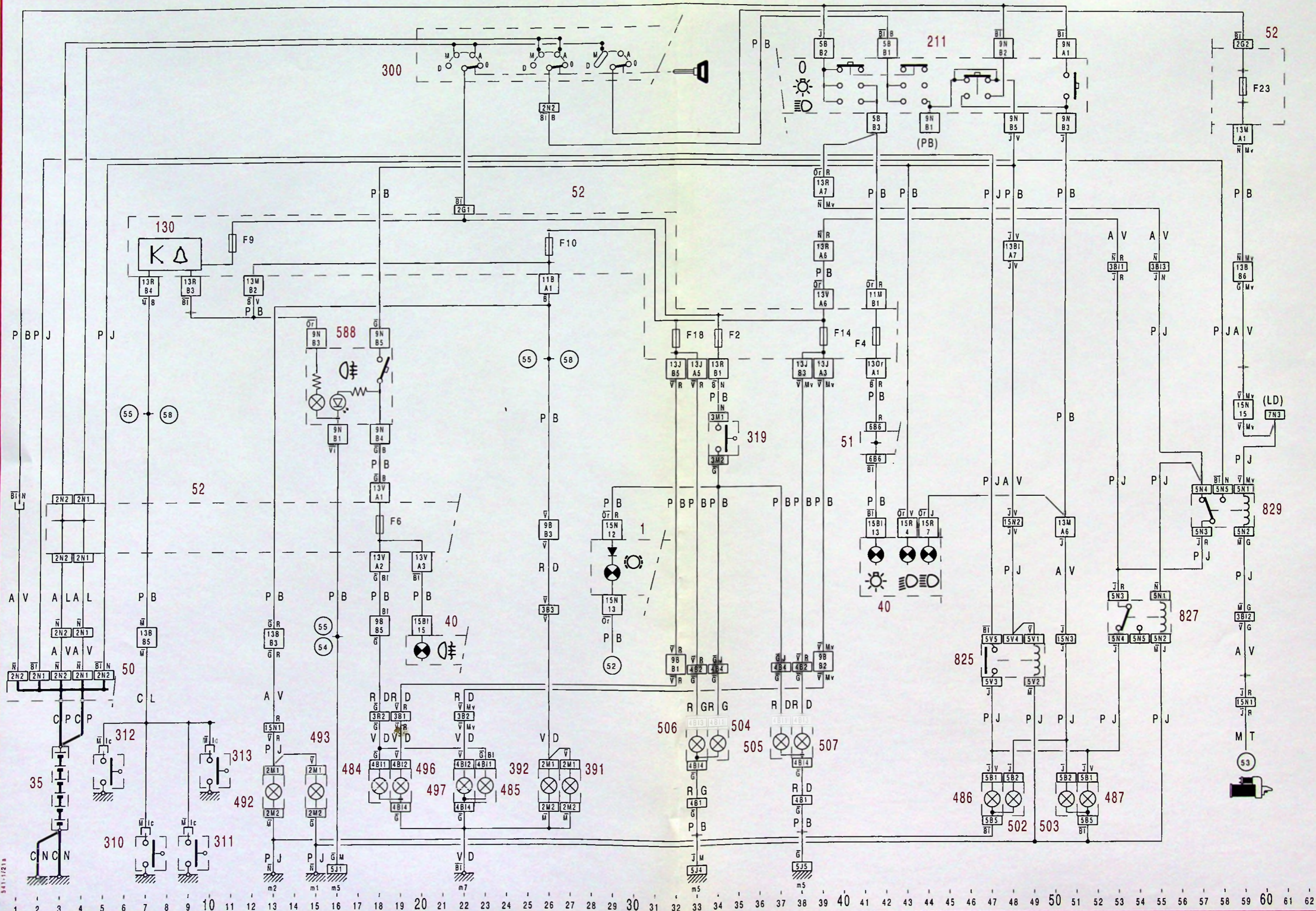

541-1/21a



54

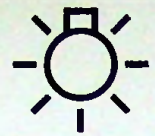

XM
541-1/21b

6

7

XM
541-1/21b

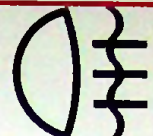
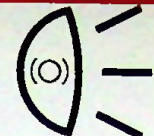

54

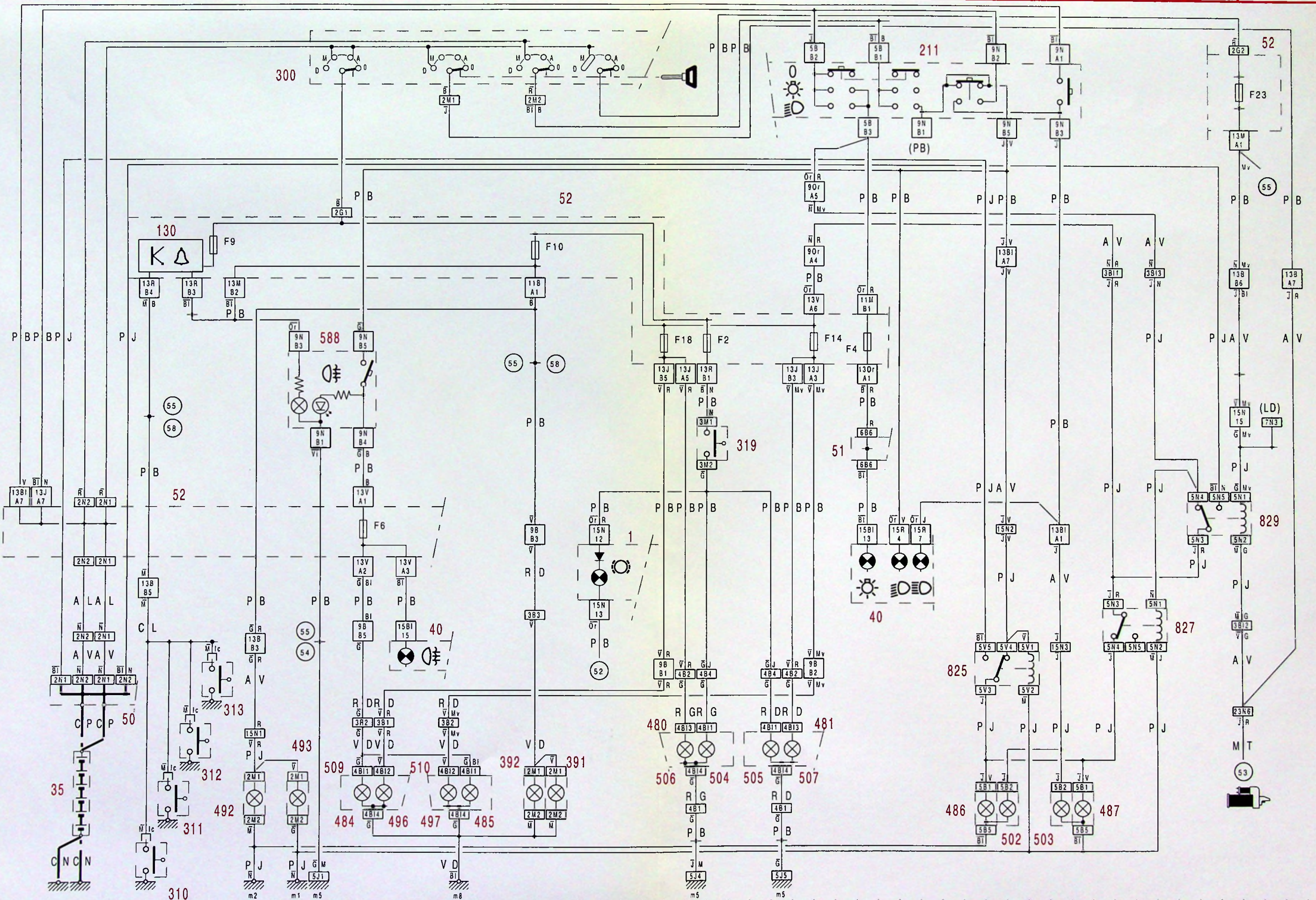

541-1/21b

541-1/21b



54

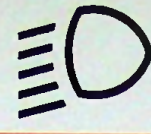

XM
541-1/30

6

7

XM
541-1/30

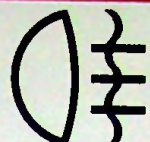

54

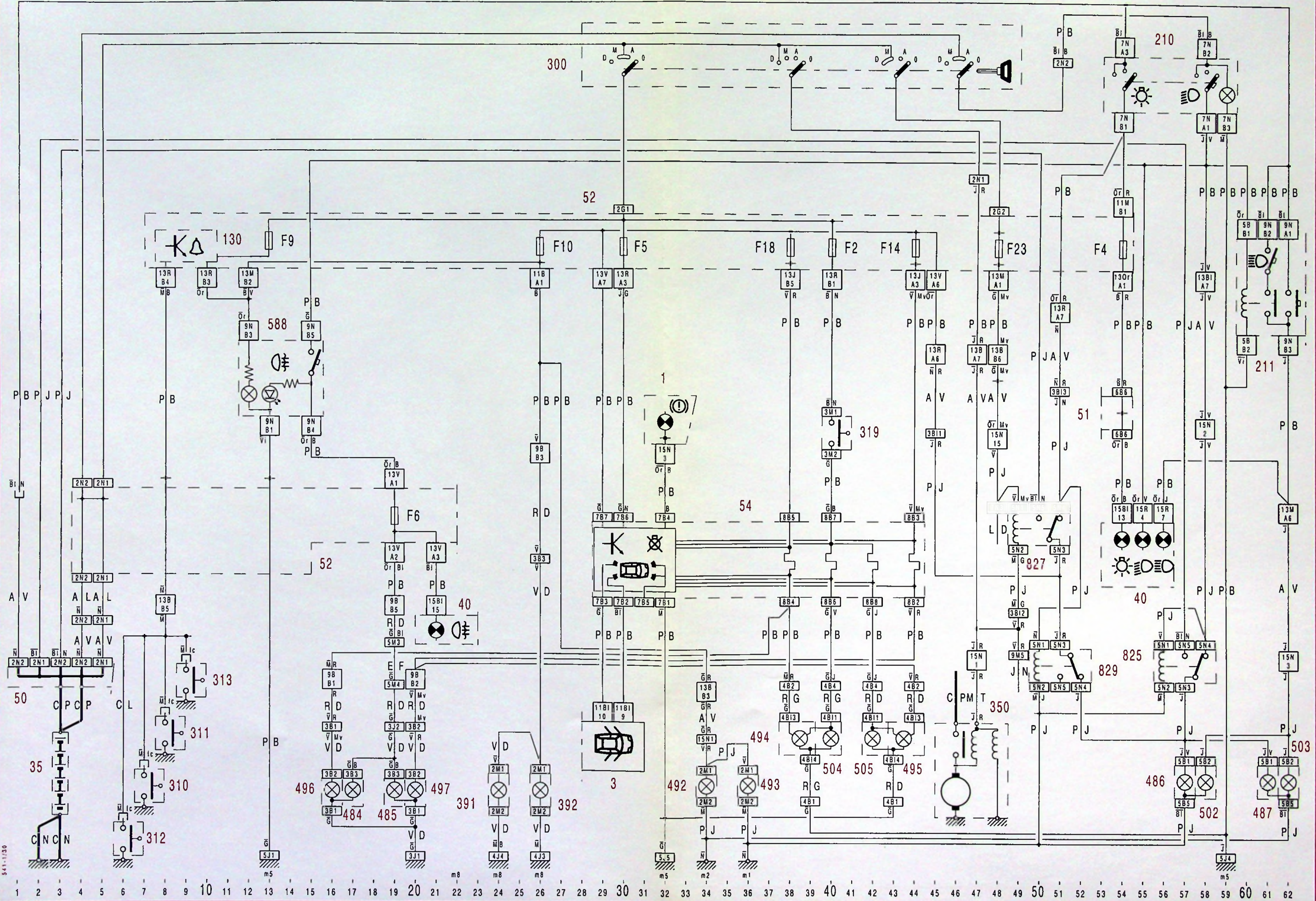

541-1/30

1 2 3 4 5 6 7 8 9 10 11 12 13 14 15 16 17 18 19 20 21 22 23 24 25 26 27 28 29 30 31 32 33 34 35 36 37 38 39 40 41 42 43 44 45 46 47 48 49 50 51 52 53 54 55 56 57 58 59 60 61 62



54

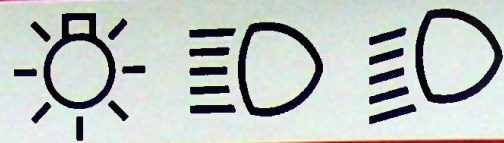

XM 541-1/30a

6

7

XM 541-1/30a

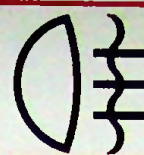
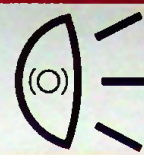
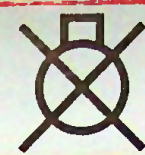

54

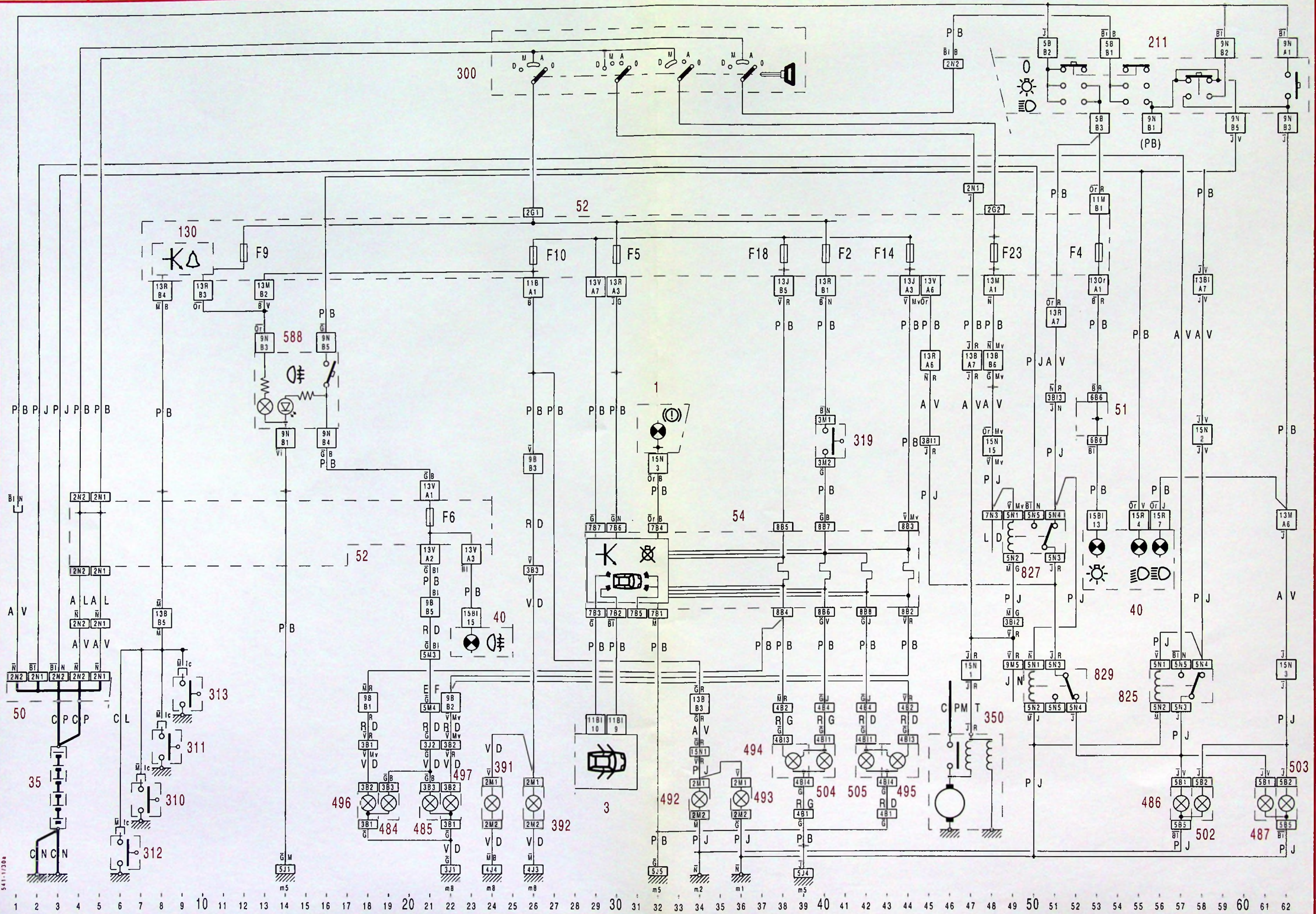

541-1/30a



54

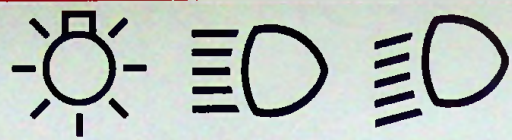

XM
541-1/30b

6

7

XM
541-1/30b

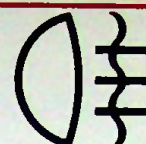
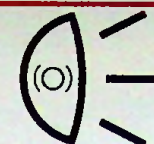

54

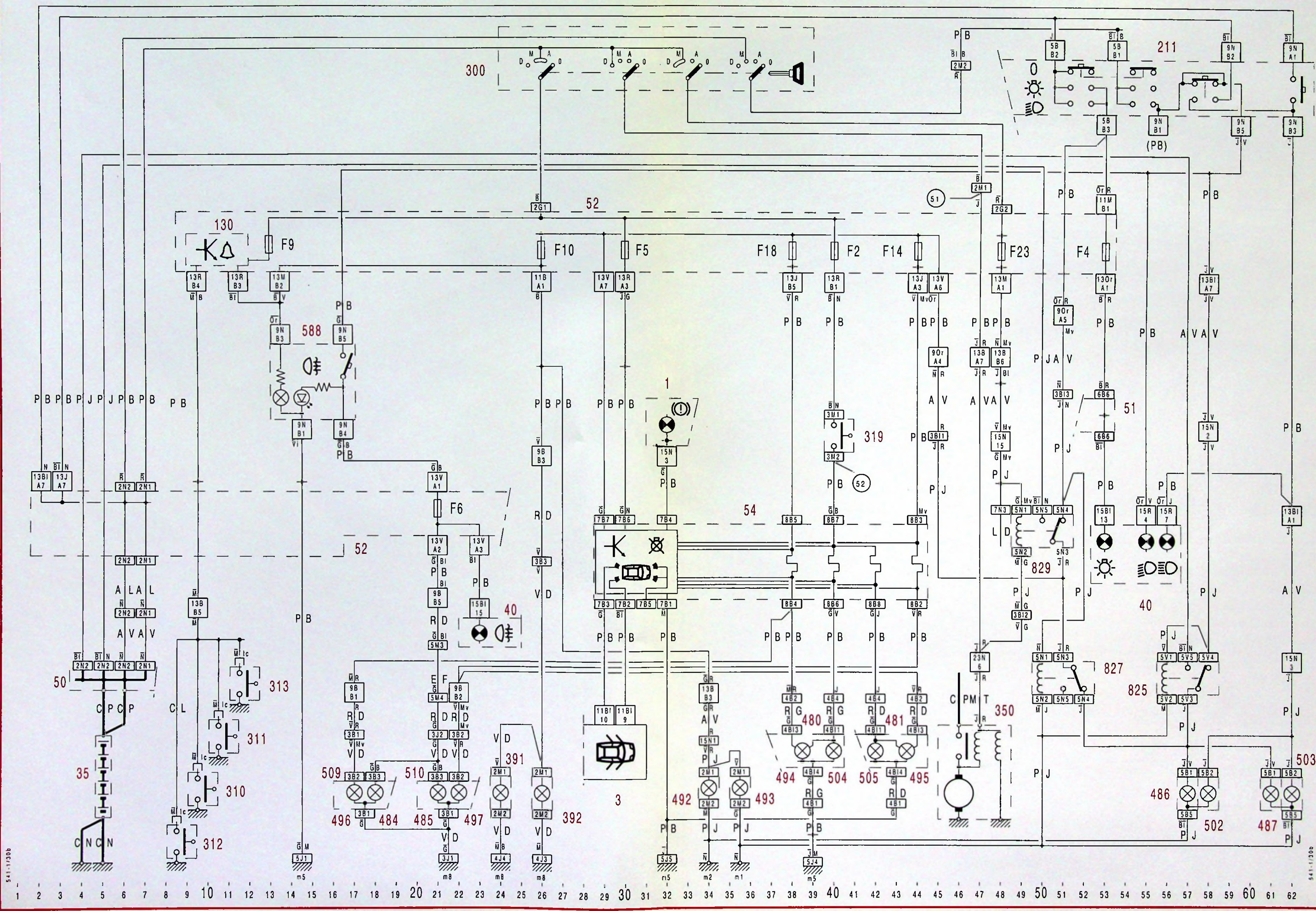

541-1/30b

541-1/30b



54

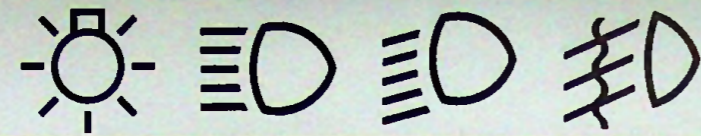

XM
541-1/31

6

7

XM
541-1/31

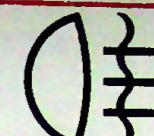
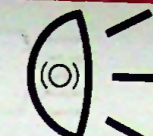

54

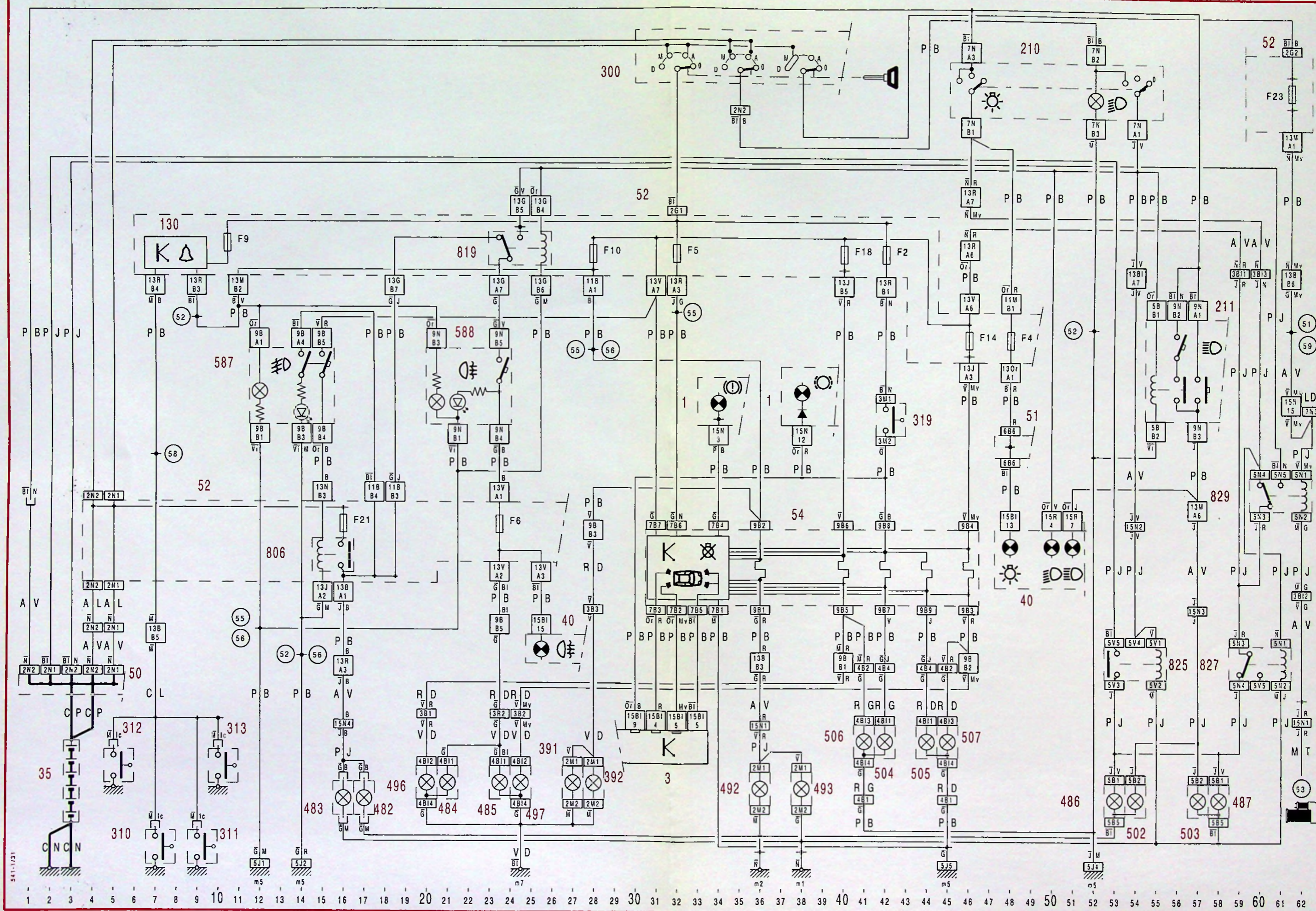

541-1/31

1 2 3 4 5 6 7 8 9 10 11 12 13 14 15 16 17 18 19 20 21 22 23 24 25 26 27 28 29 30 31 32 33 34 35 36 37 38 39 40 41 42 43 44 45 46 47 48 49 50 51 52 53 54 55 56 57 58 59 60 61 62



54



XM
541-1/31a

6

7

XM
541-1/31a



54

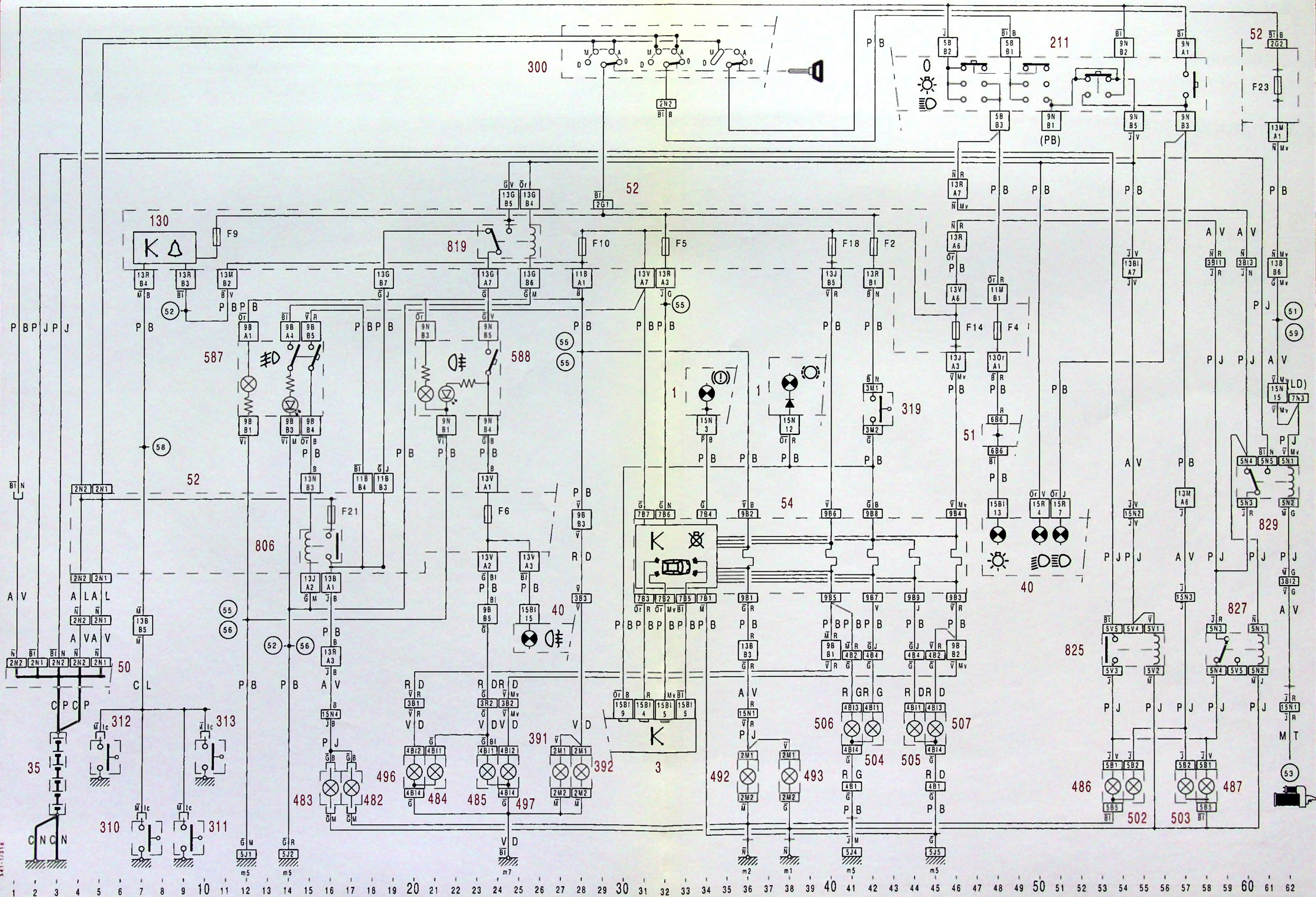



54



XM
541-1/31b

6

7

XM
541-1/31b

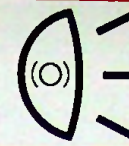

54

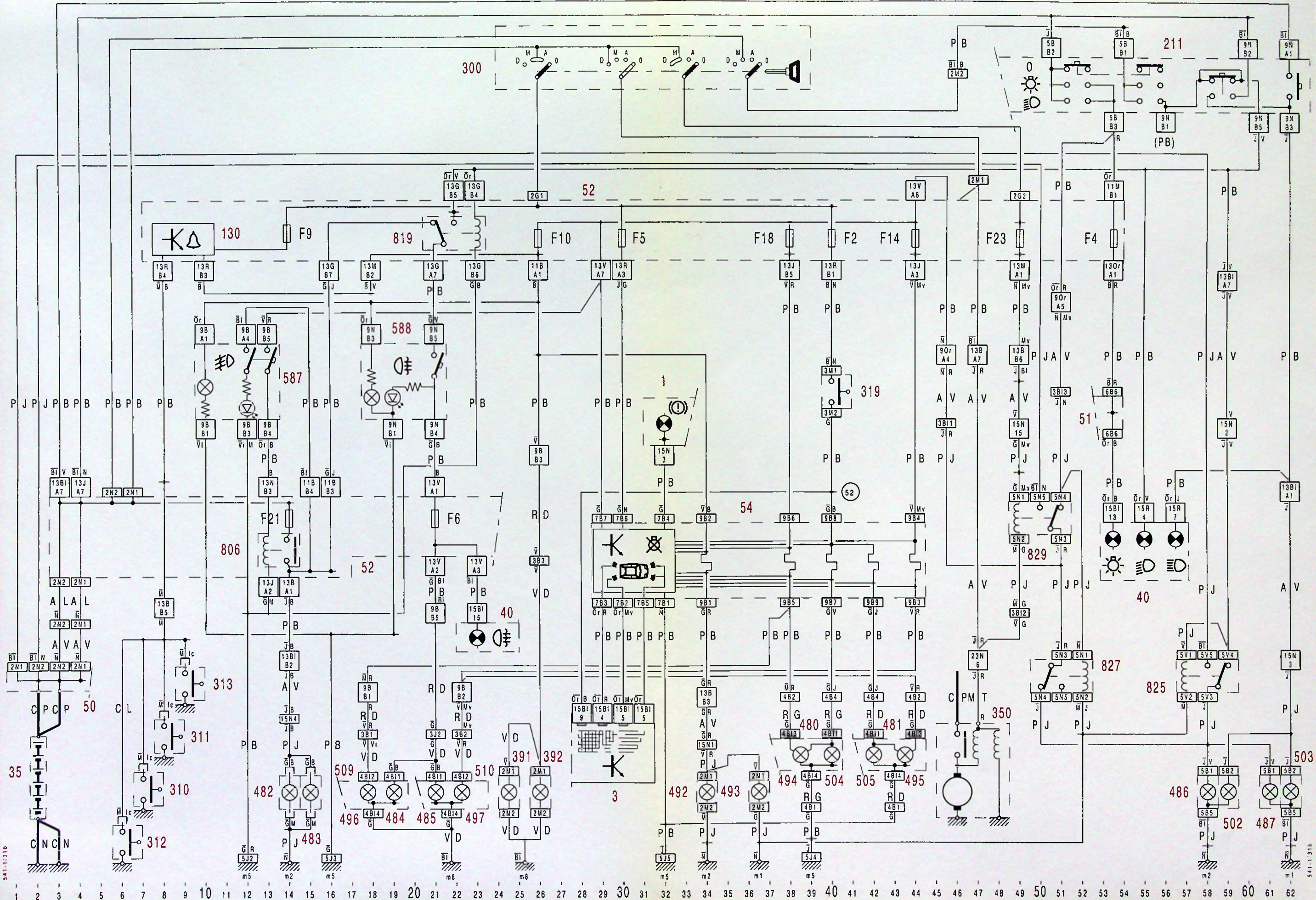

541-1/31b

541-1/31b



54

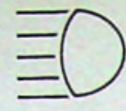

XM
541-1/40

3

4

XM
541-1/40



54

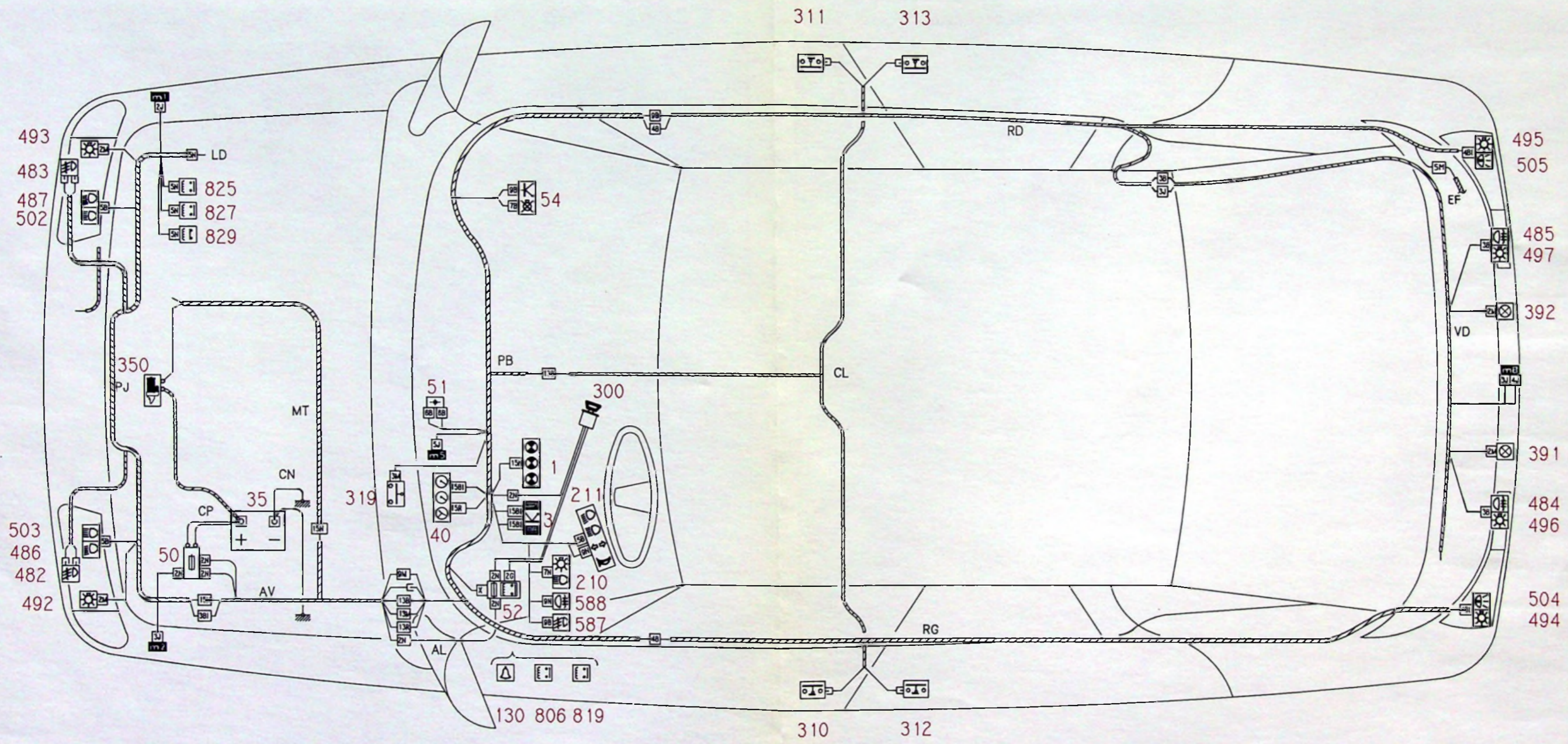



54

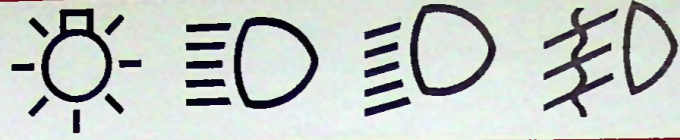

XM
541-1/40

6

7

XM
541-1/40

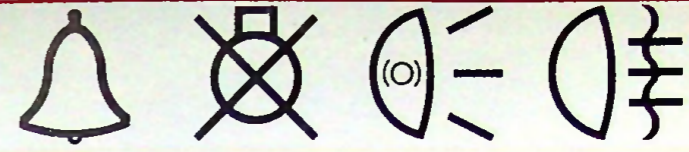

54

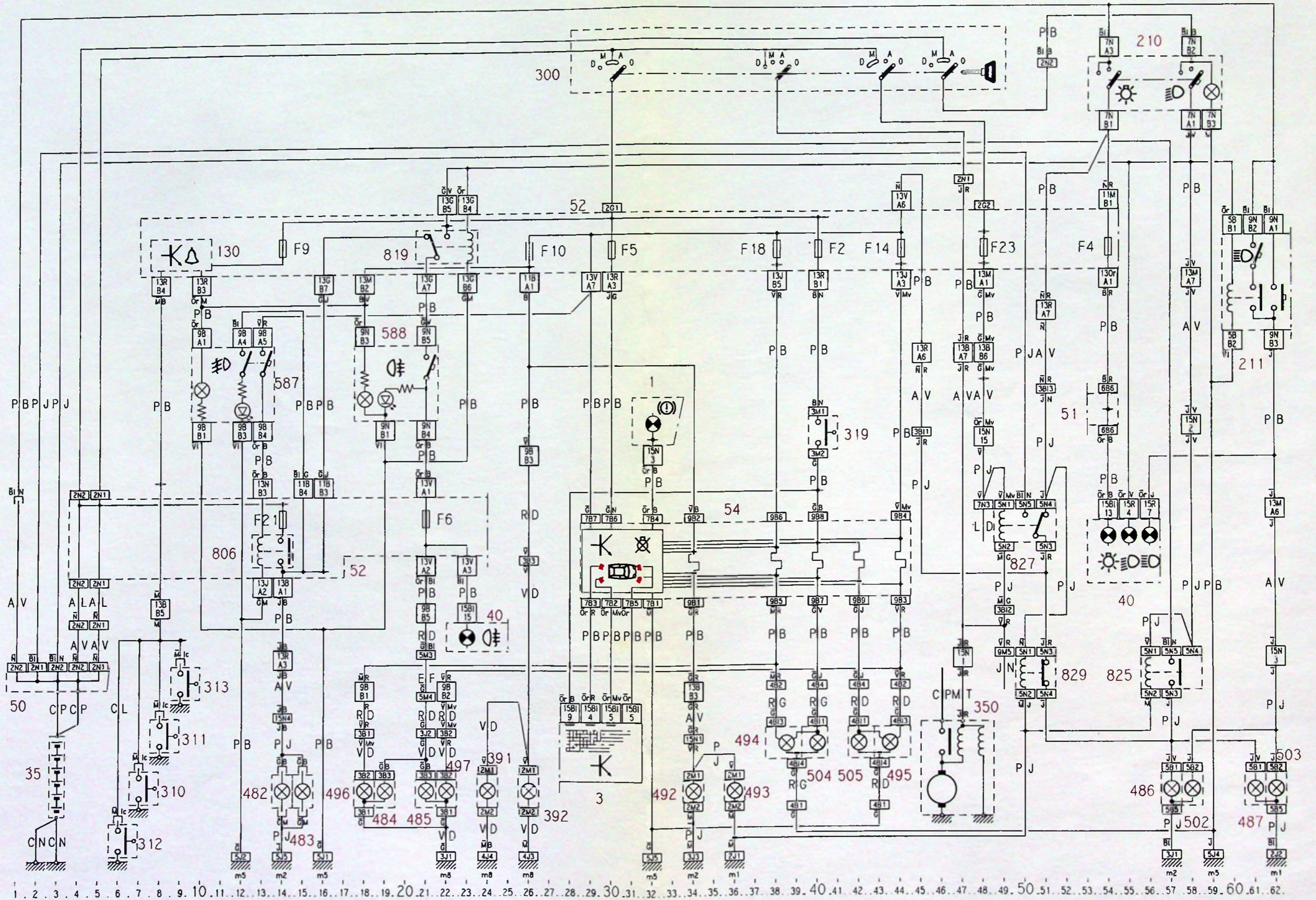



54

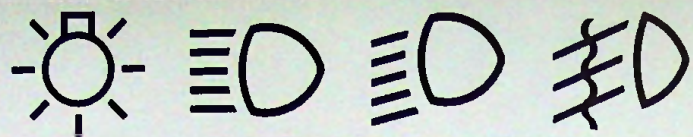

XM
541-1/40a

6

7

XM
541-1/40a

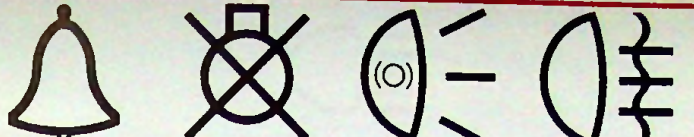

54

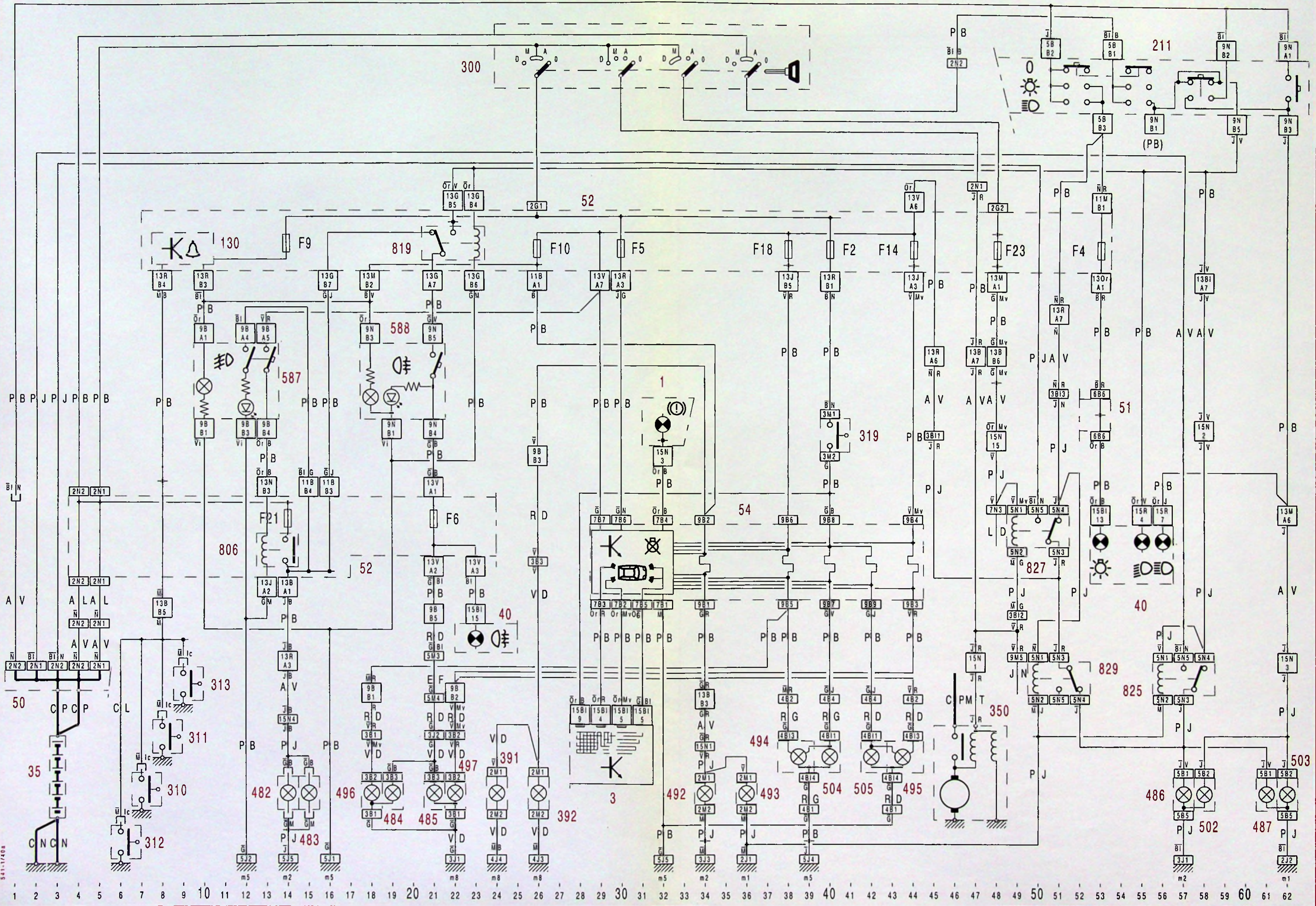



54

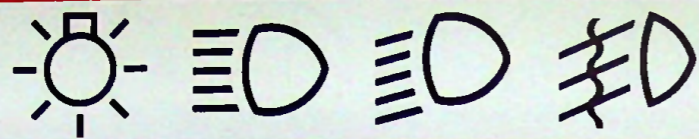

XM
541-1/40b

6

7

XM
541-1/40b

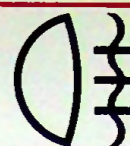
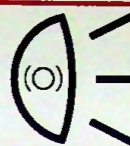

54

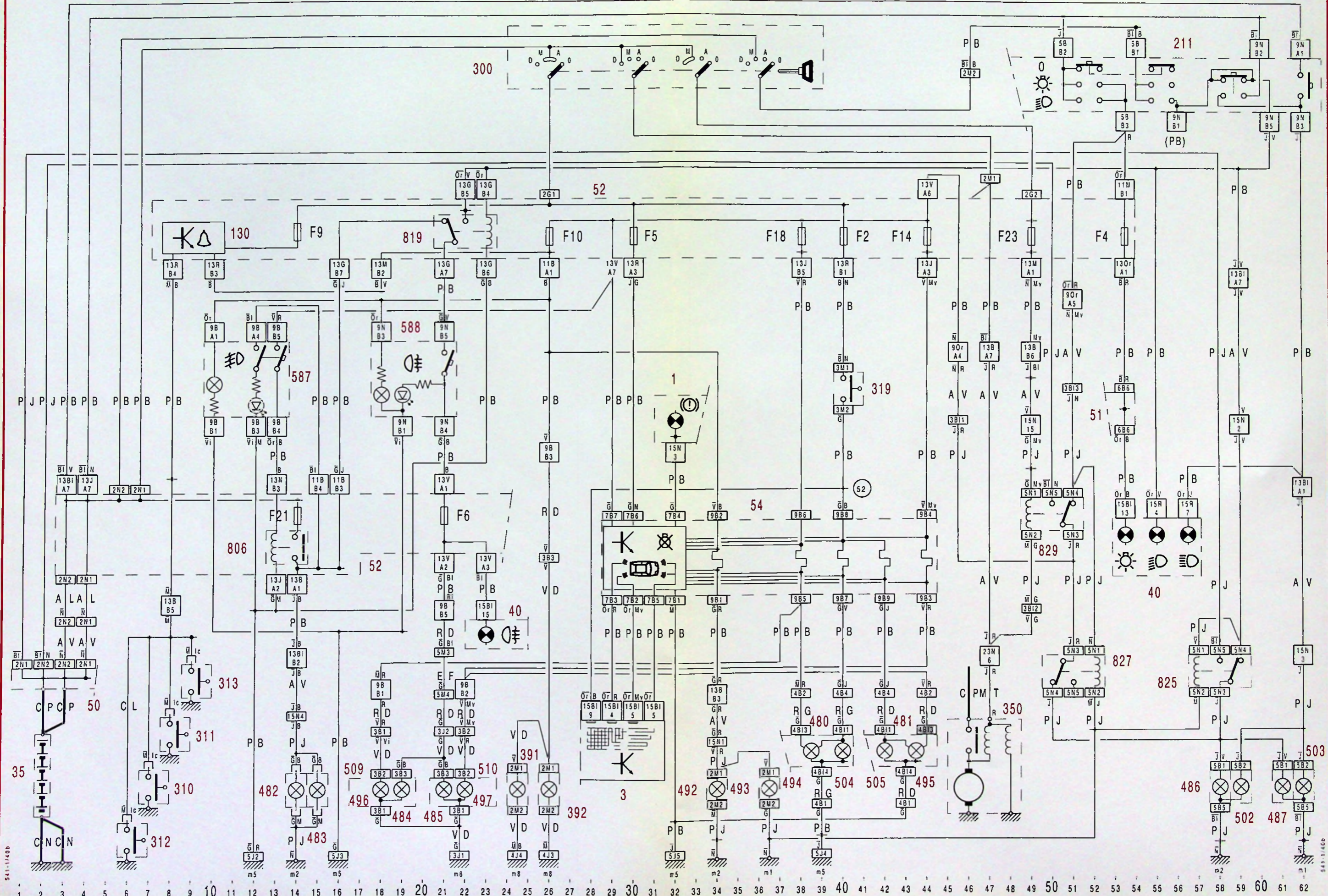

541-1/40b

541-1/40b



54

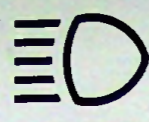
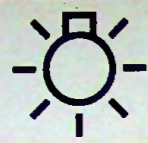

XM
541-2/20

6

7

XM
541-2/20

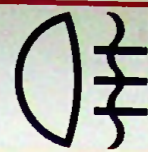
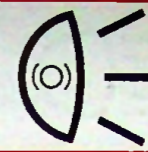

54

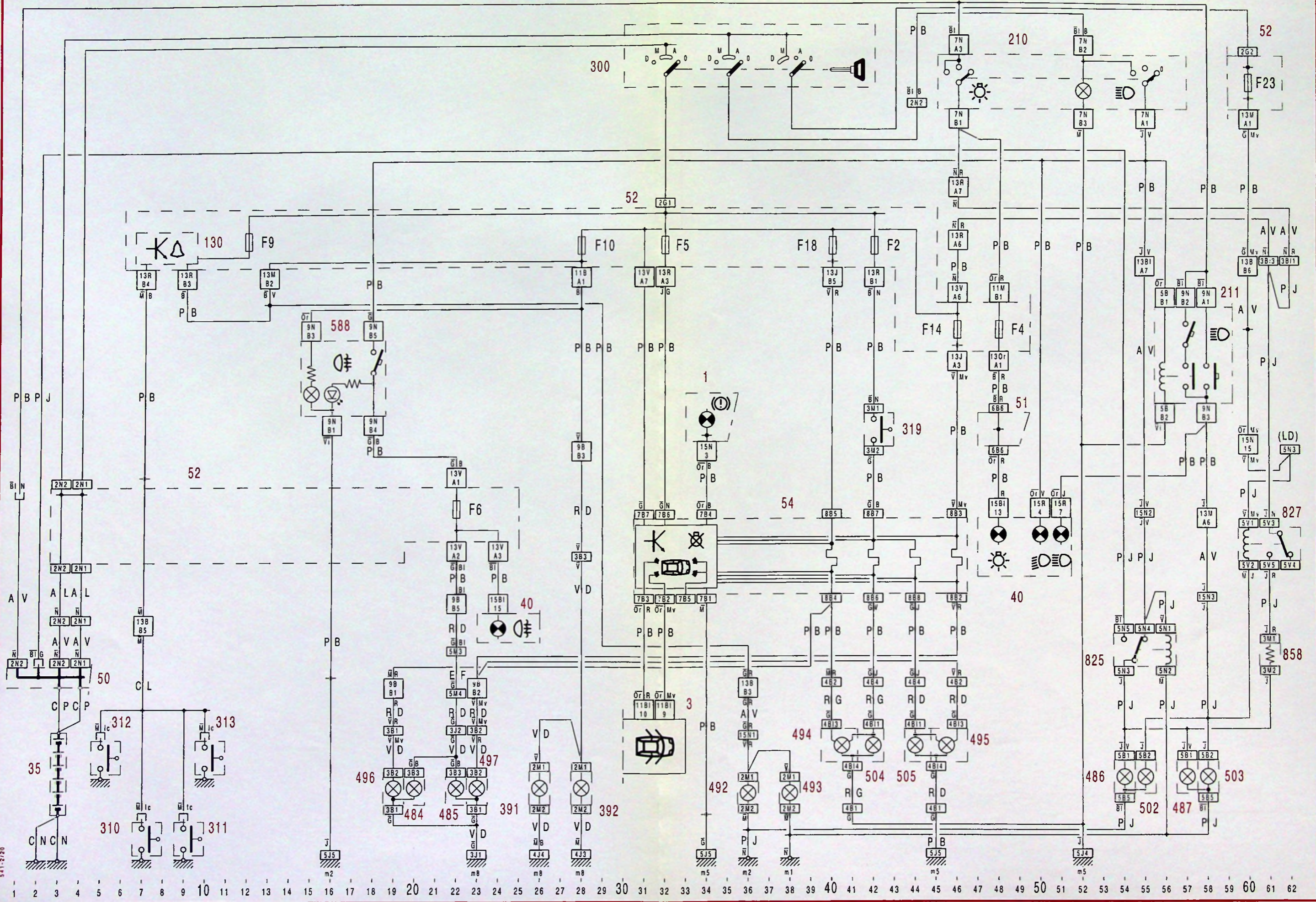

541-2/20



54

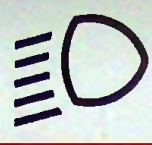
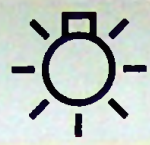

XM
541-2/20a

6

7

XM
541-2/20a

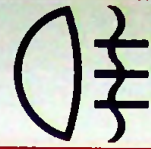
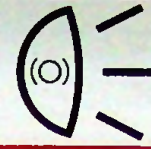

54

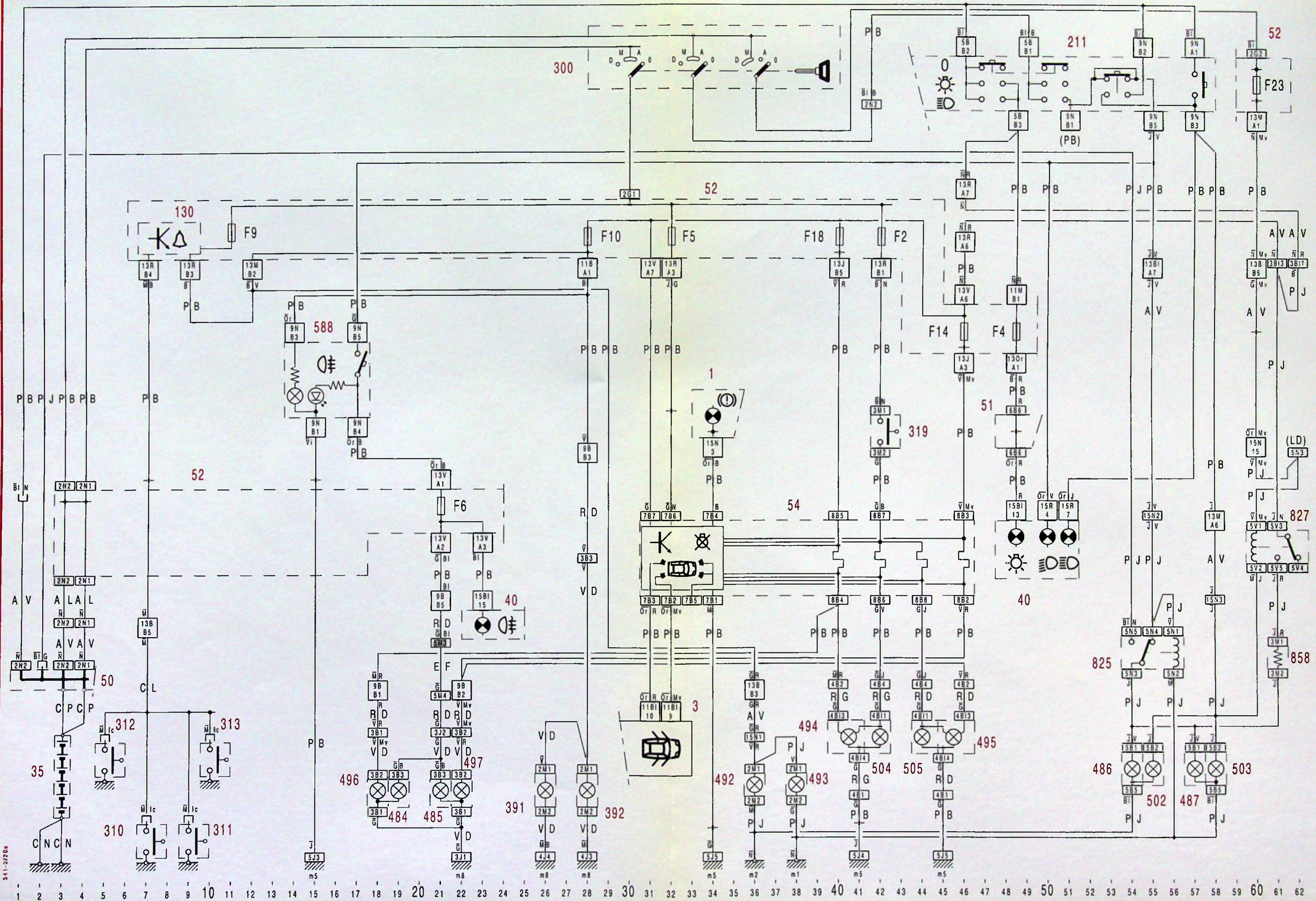

541-2/20a

1 2 3 4 5 6 7 8 9 10 11 12 13 14 15 16 17 18 19 20 21 22 23 24 25 26 27 28 29 30 31 32 33 34 35 36 37 38 39 40 41 42 43 44 45 46 47 48 49 50 51 52 53 54 55 56 57 58 59 60 61 62



54



XM
541-2/20b

6

7

XM
541-2/20b

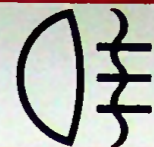
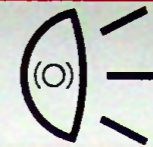

54

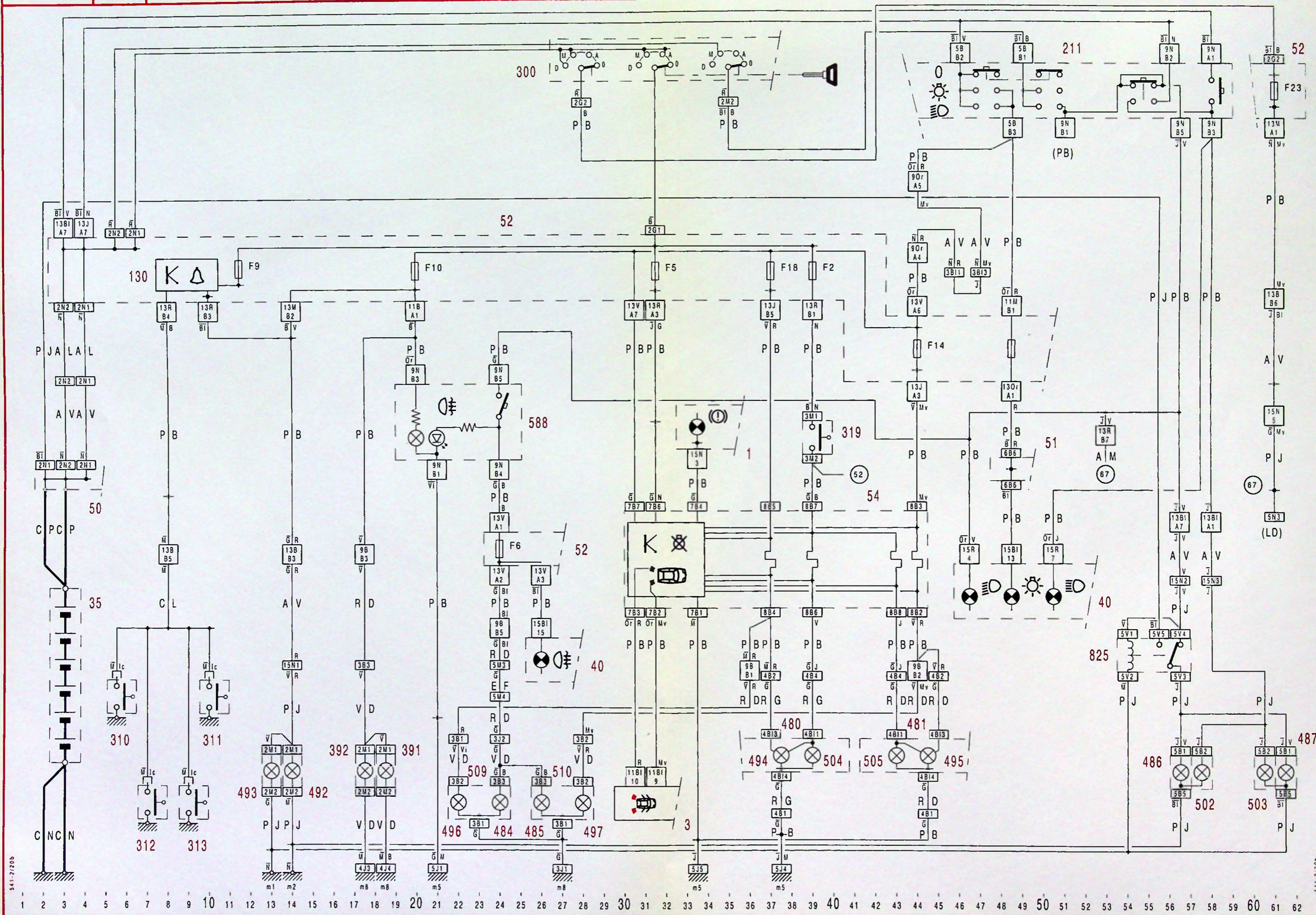

541-2/20b

541-2/20b



54



XM
541-2/21

6

7

XM
541-2/21

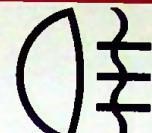
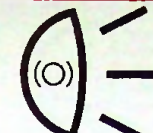

54

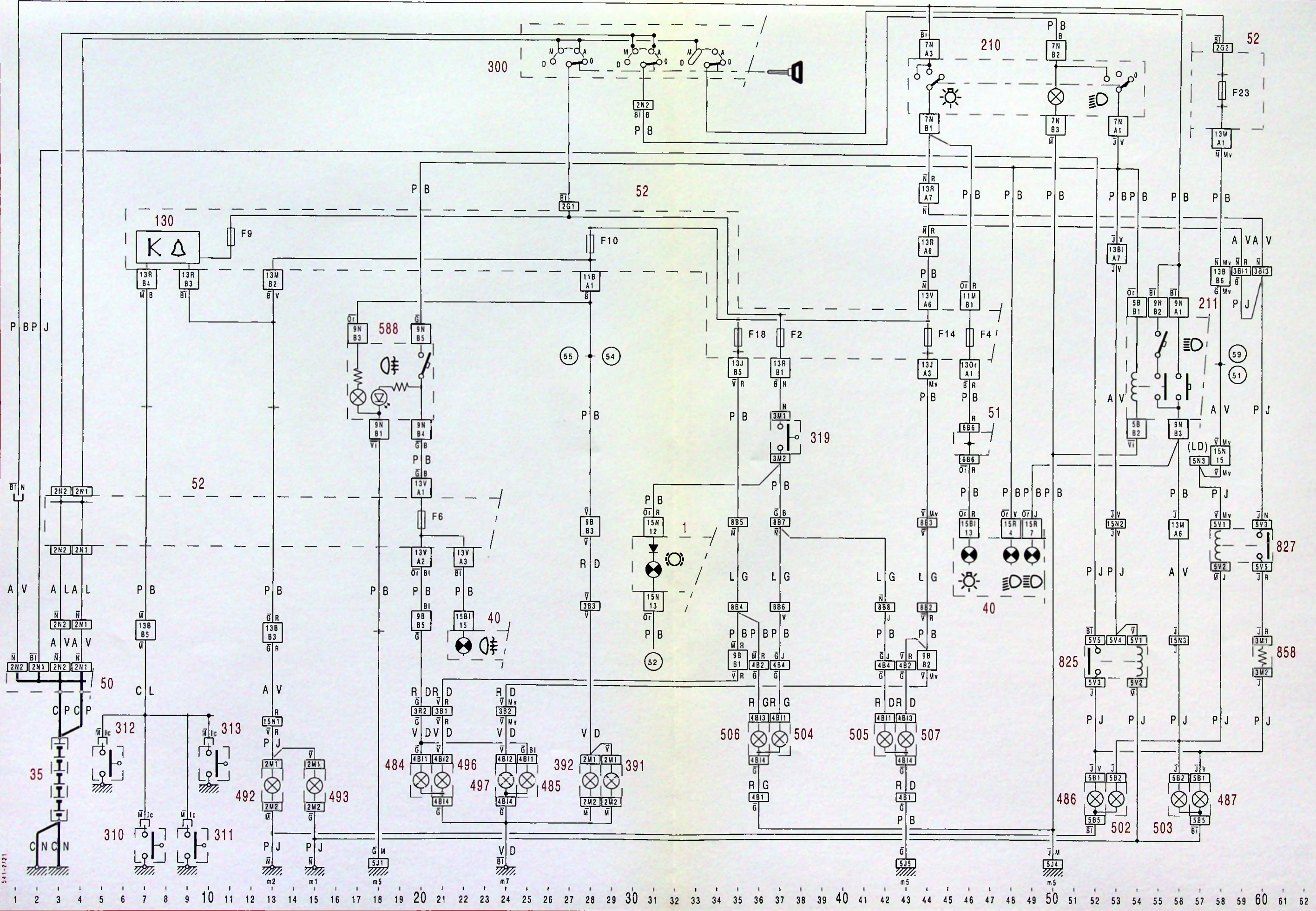

541-2/21

1 2 3 4 5 6 7 8 9 10 11 12 13 14 15 16 17 18 19 20 21 22 23 24 25 26 27 28 29 30 31 32 33 34 35 36 37 38 39 40 41 42 43 44 45 46 47 48 49 50 51 52 53 54 55 56 57 58 59 60 61 62



54



XM
541-2/21a

6

7

XM
541-2/21a

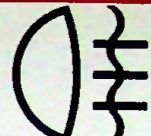
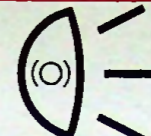

54

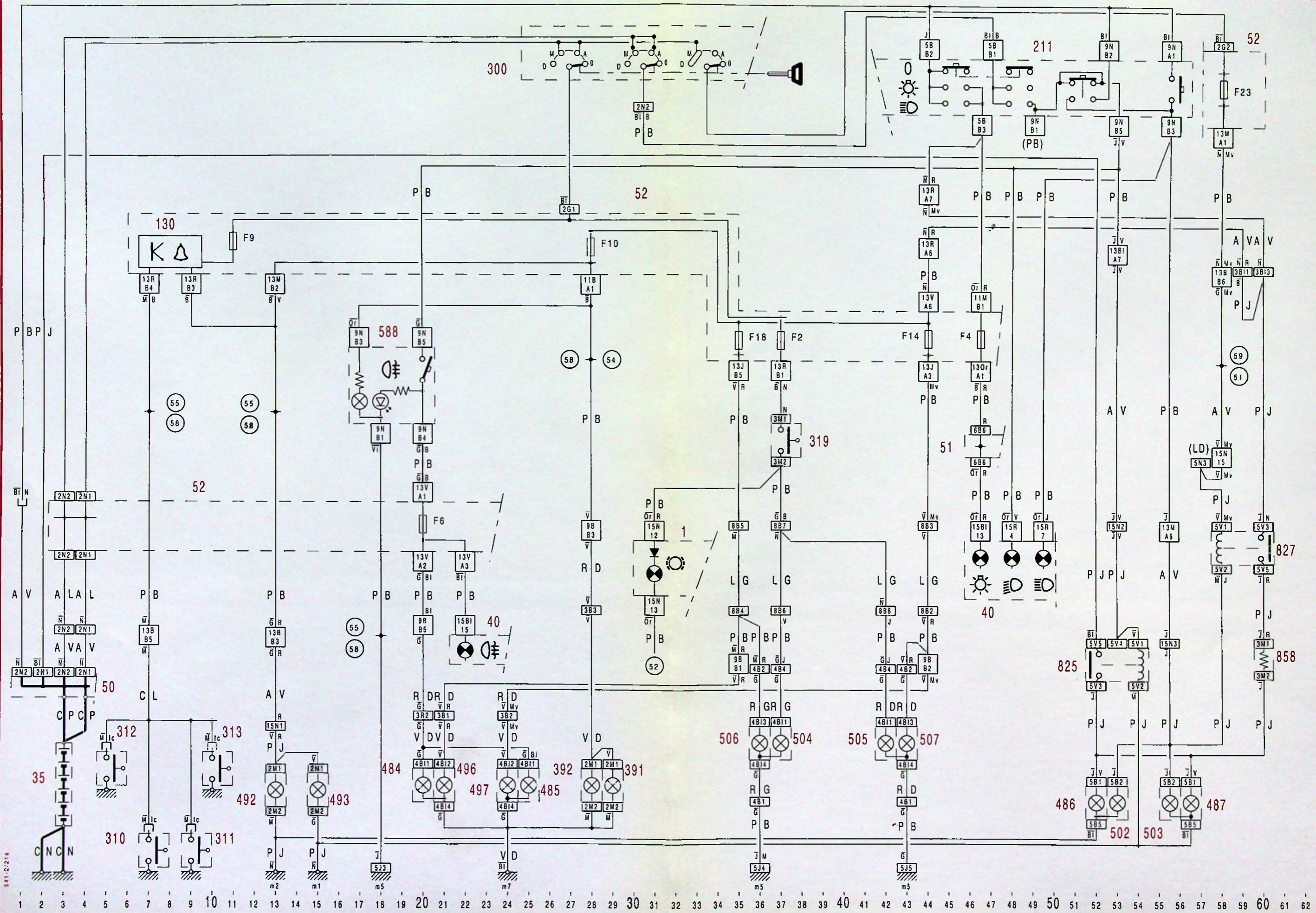

541-2/21a



54



XM
541-2/21b

6

7

XM
541-2/21b

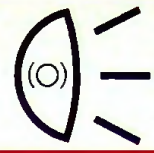

54

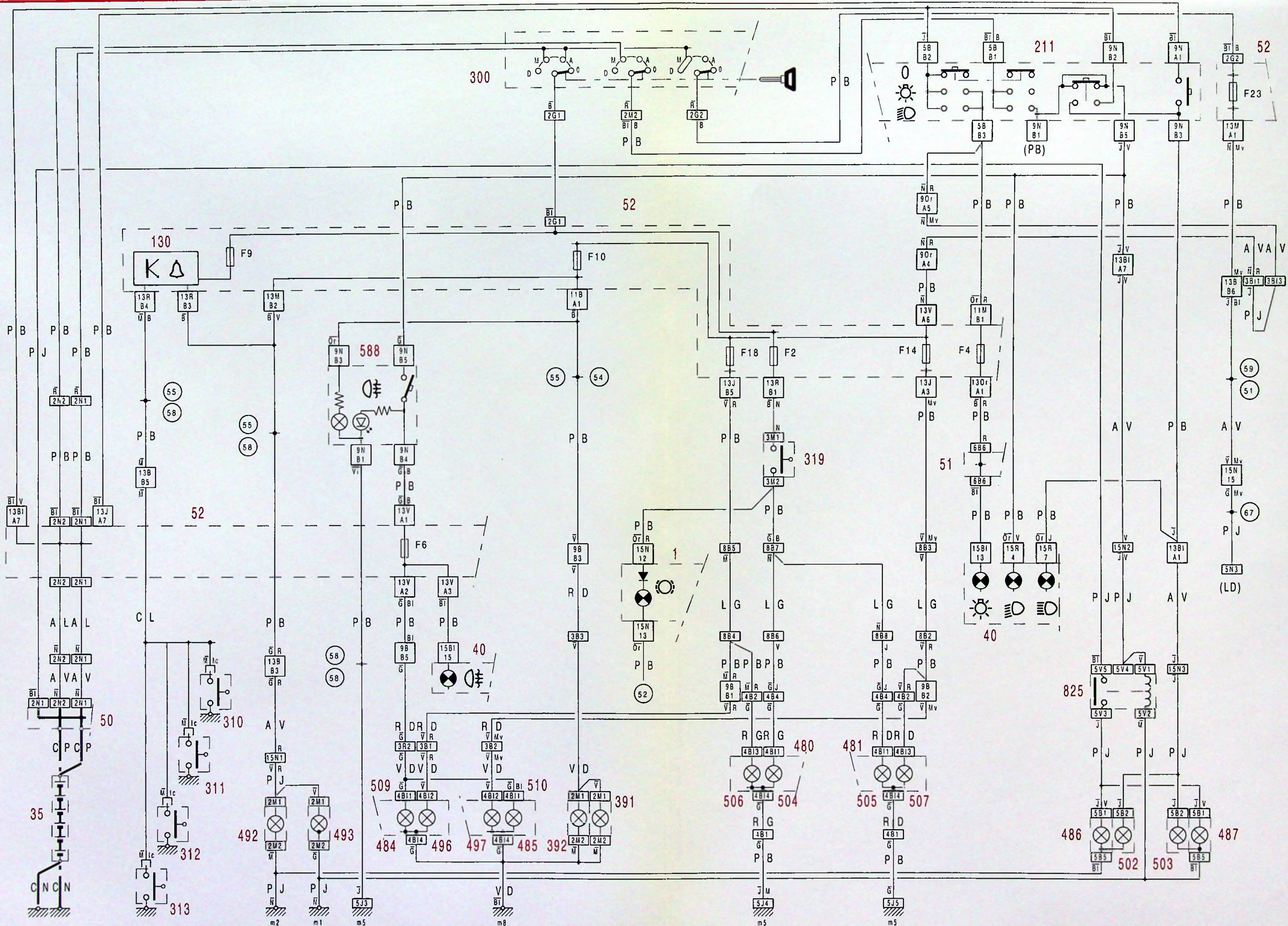

541-2/21b

541-2/21b

1 2 3 4 5 6 7 8 9 10 11 12 13 14 15 16 17 18 19 20 21 22 23 24 25 26 27 28 29 30 31 32 33 34 35 36 37 38 39 40 41 42 43 44 45 46 47 48 49 50 51 52 53 54 55 56 57 58 59 60 61 62



54

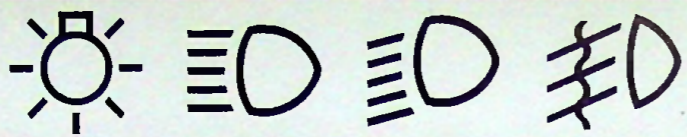

XM
541-2/30

6

7

XM
541-2/30

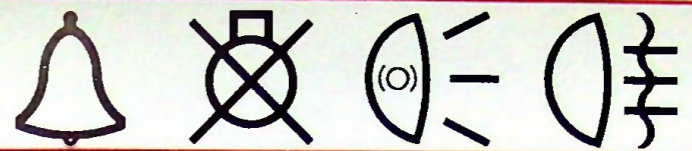

54

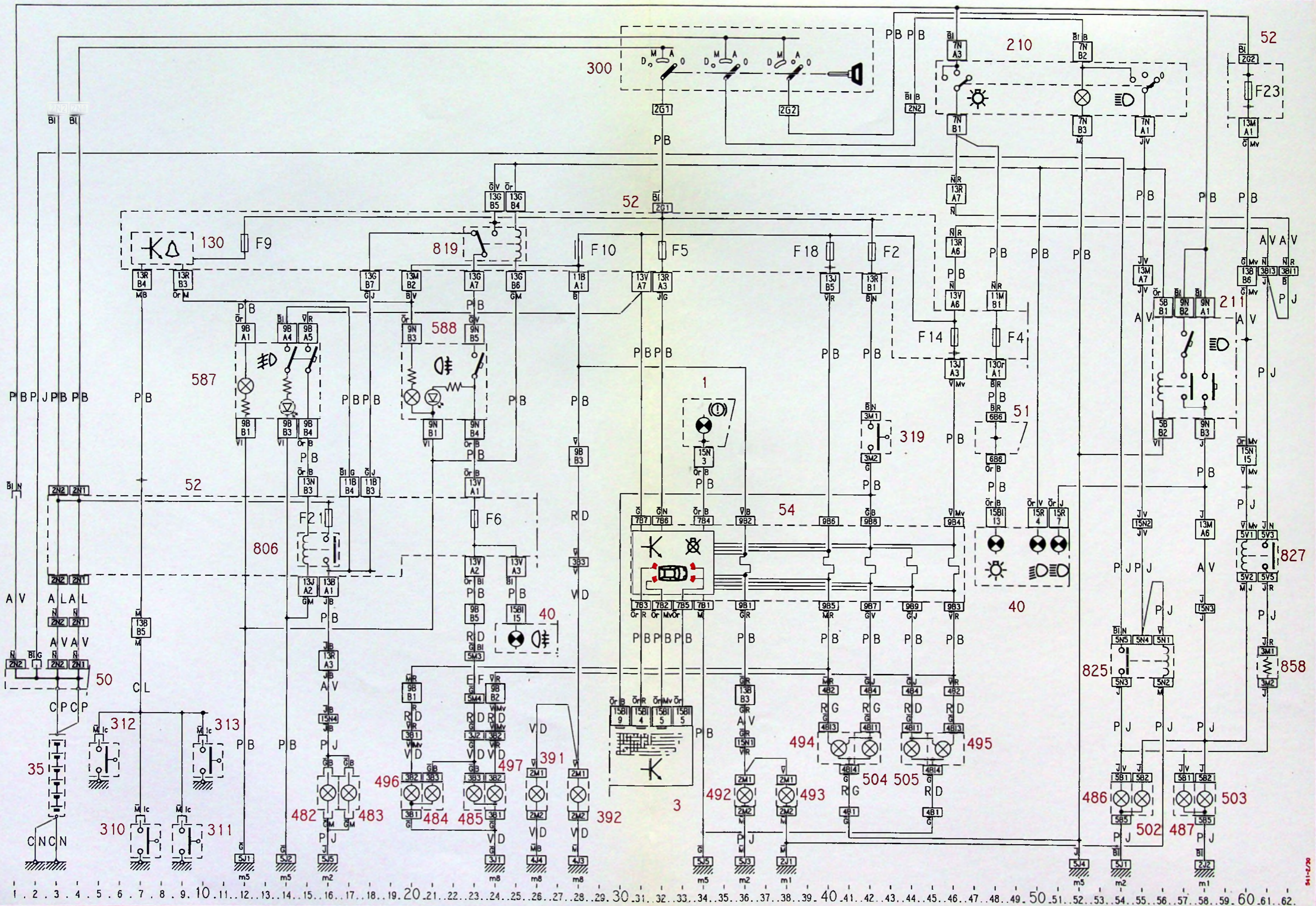

541-2/30



54

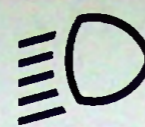
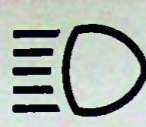

XM
541-2/30a

6

7

XM
541-2/30a

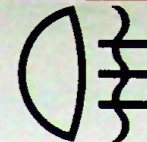
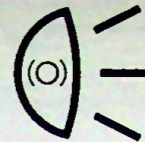

54

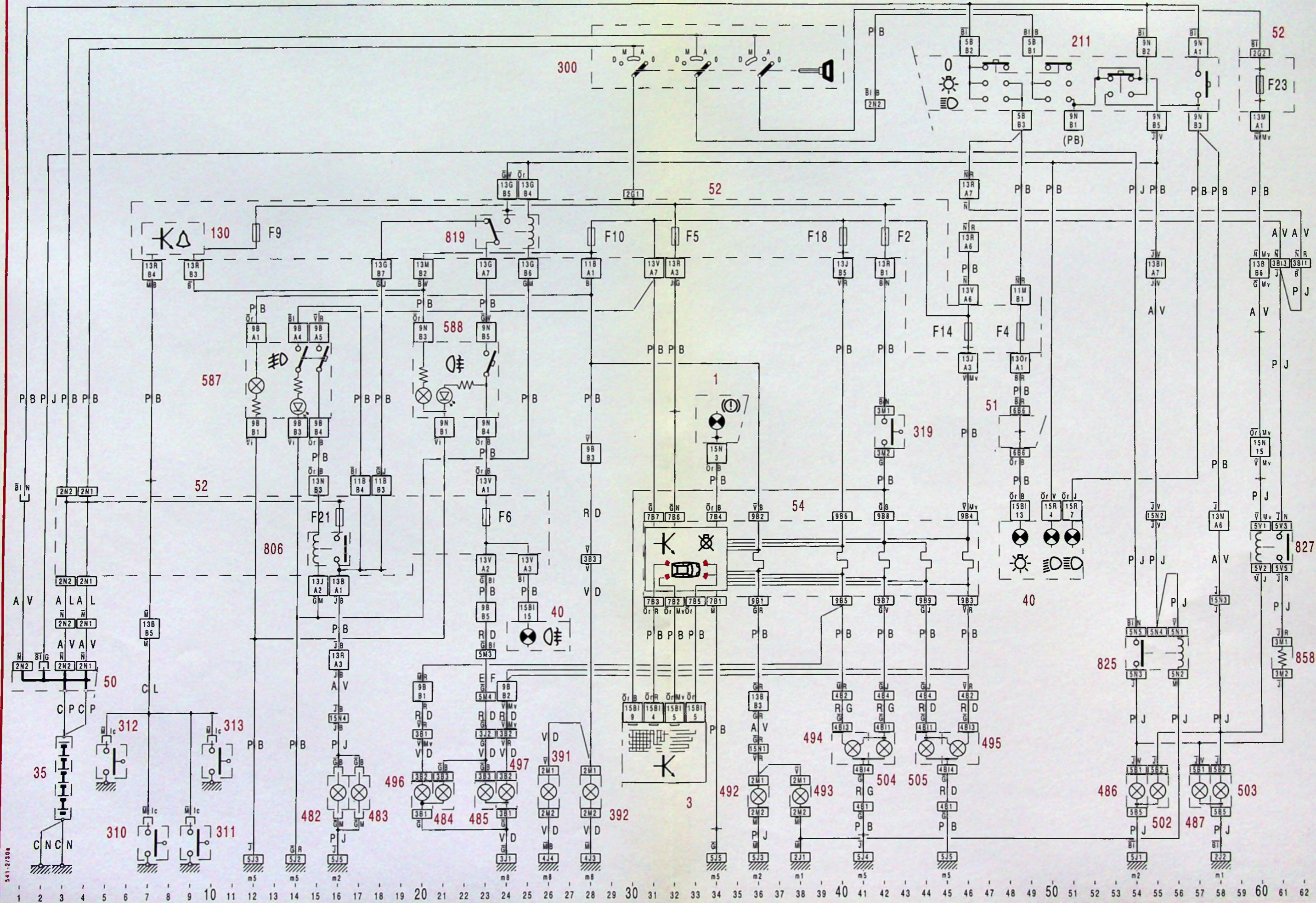



54

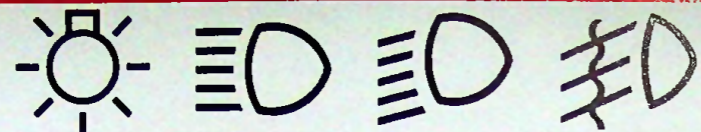

XM
541-2/30b

6

7

XM
541-2/30b

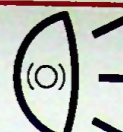

54

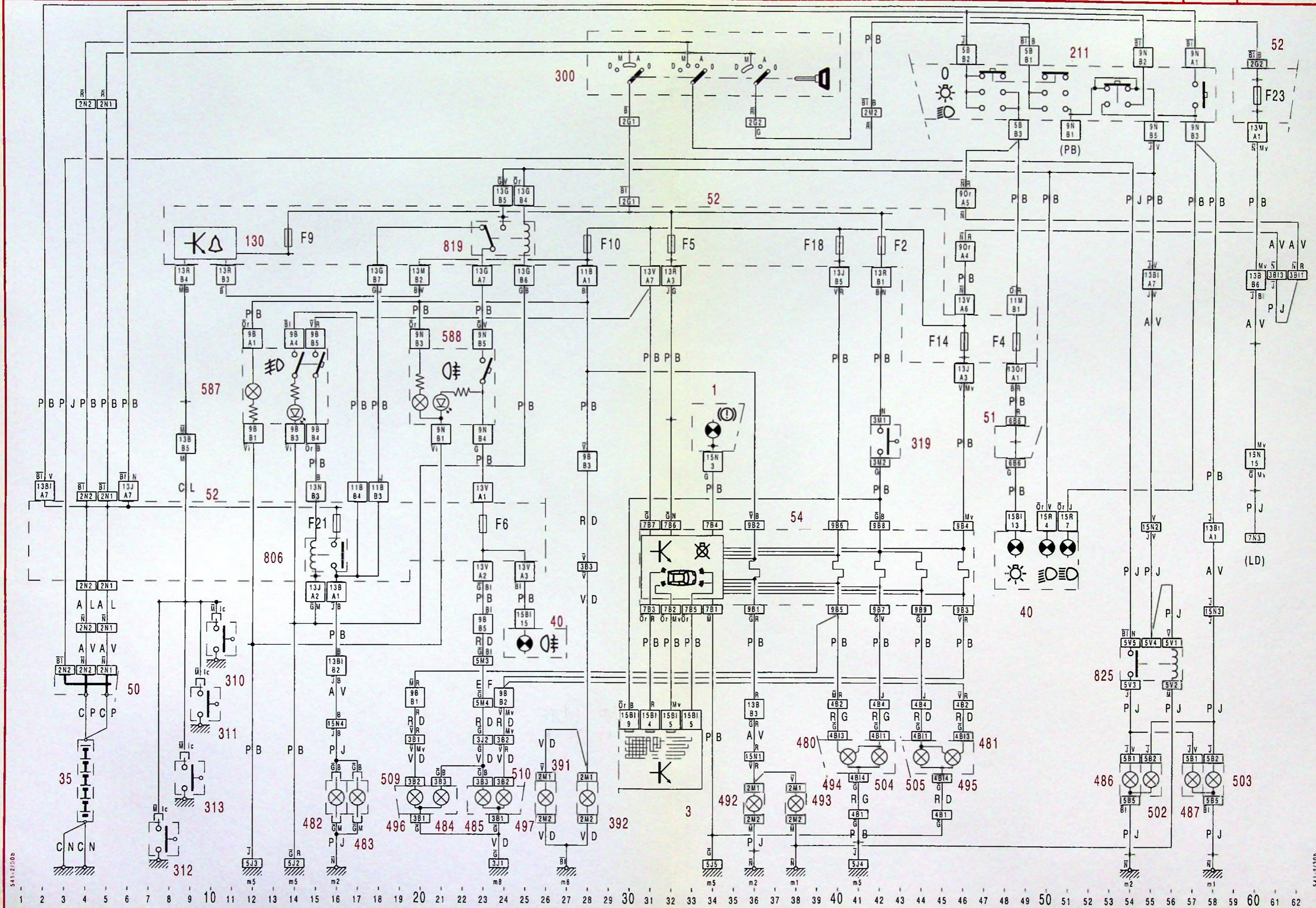

541-2/30b

541-2/30b



54

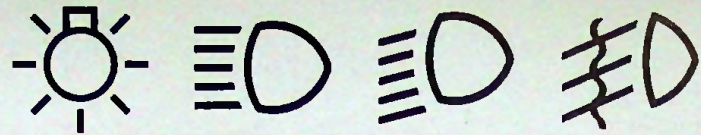

XM
541-2/31

6

7

XM
541-2/31

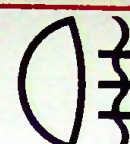
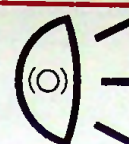

54

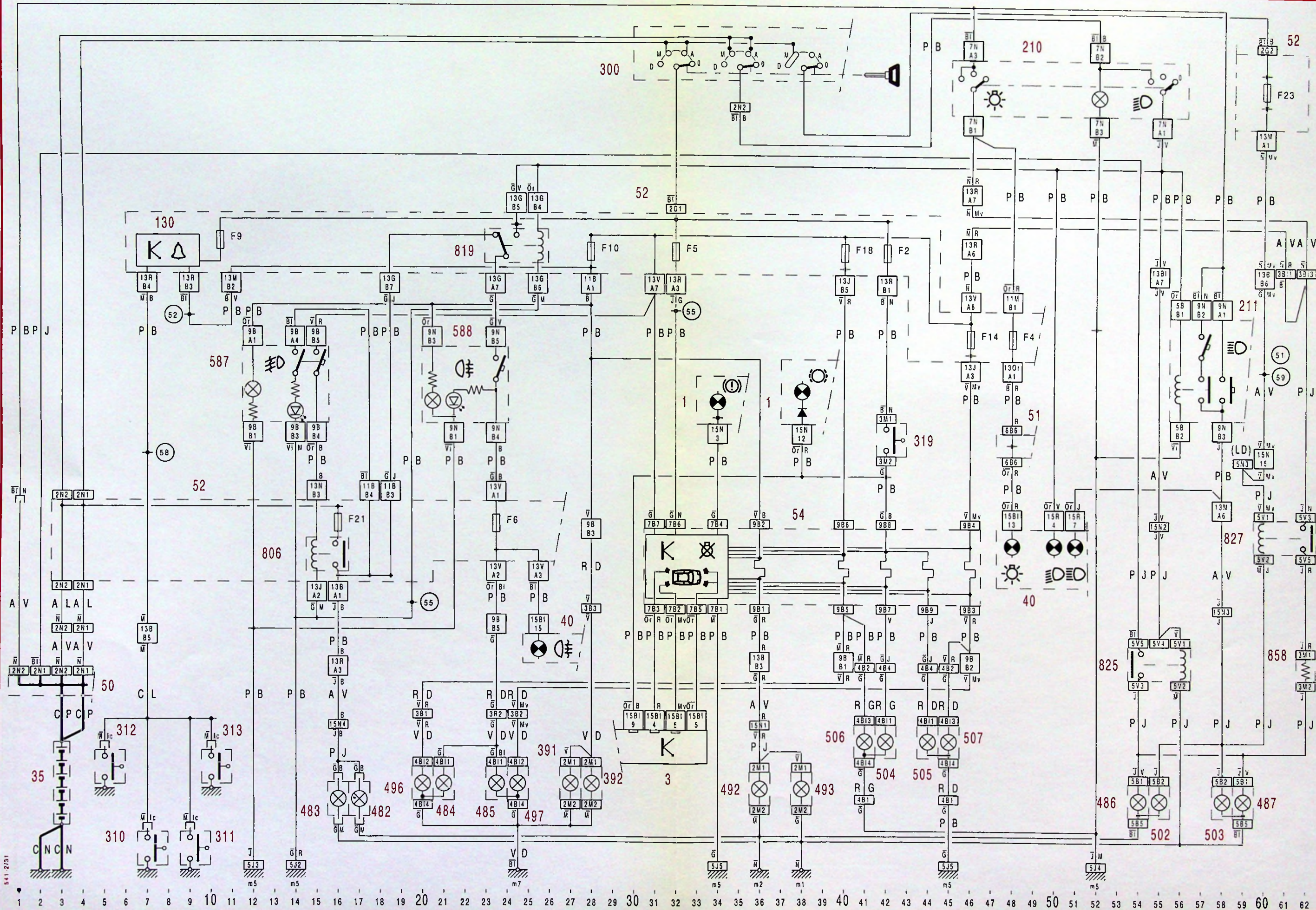

541-2/31

1 2 3 4 5 6 7 8 9 10 11 12 13 14 15 16 17 18 19 20 21 22 23 24 25 26 27 28 29 30 31 32 33 34 35 36 37 38 39 40 41 42 43 44 45 46 47 48 49 50 51 52 53 54 55 56 57 58 59 60 61 62



54

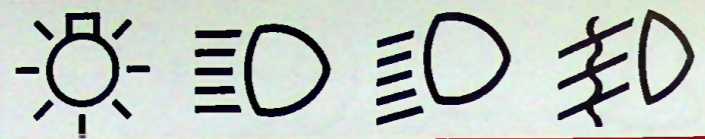

XM
541-2/31a

6

7

XM
541-2/31a

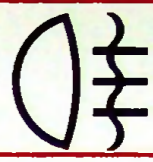
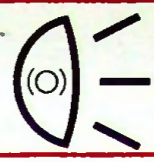

54

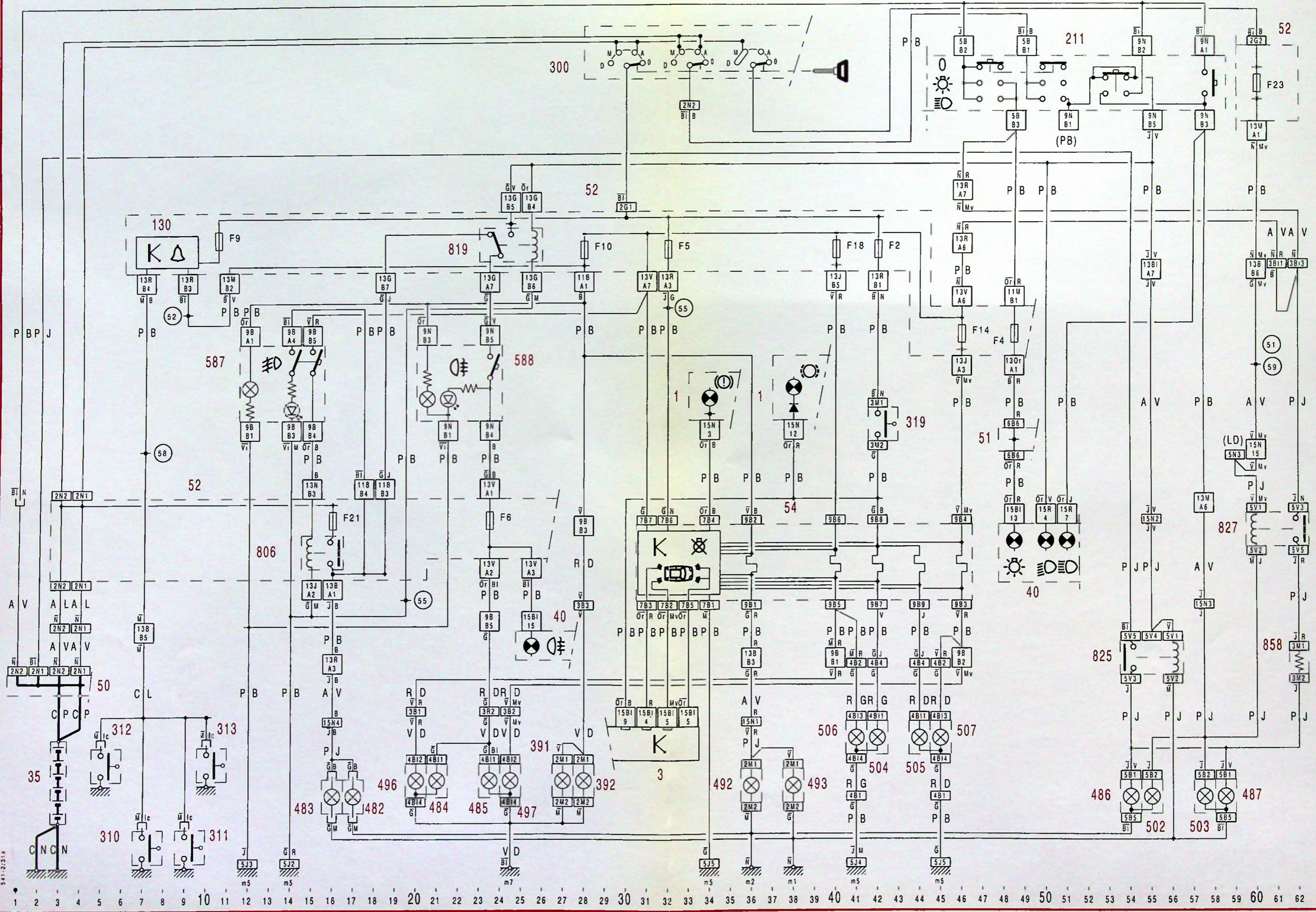

541-2/31a



54

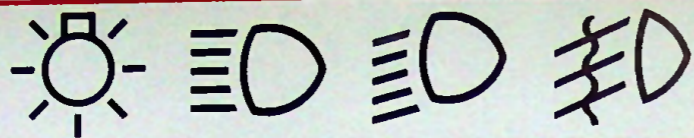

XM
541-2/31b

6

7

XM
541-2/31b

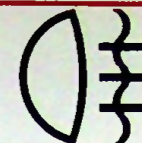
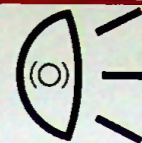

54

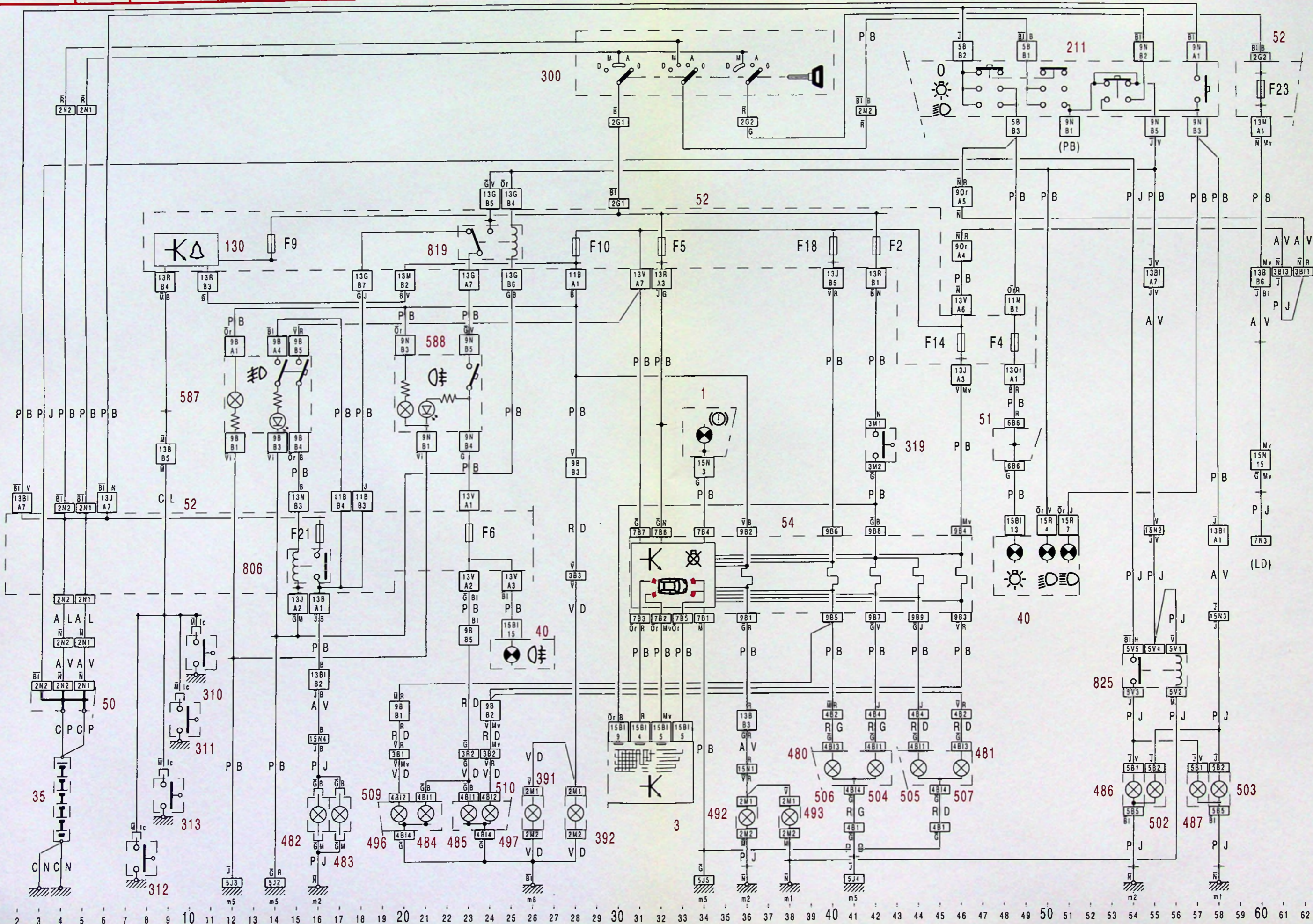

541-2/31b

541-2/31b



54

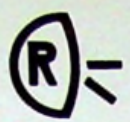
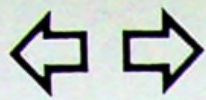

XM
542-00/10

3

4

XM
542-00/10

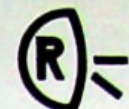
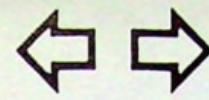

54

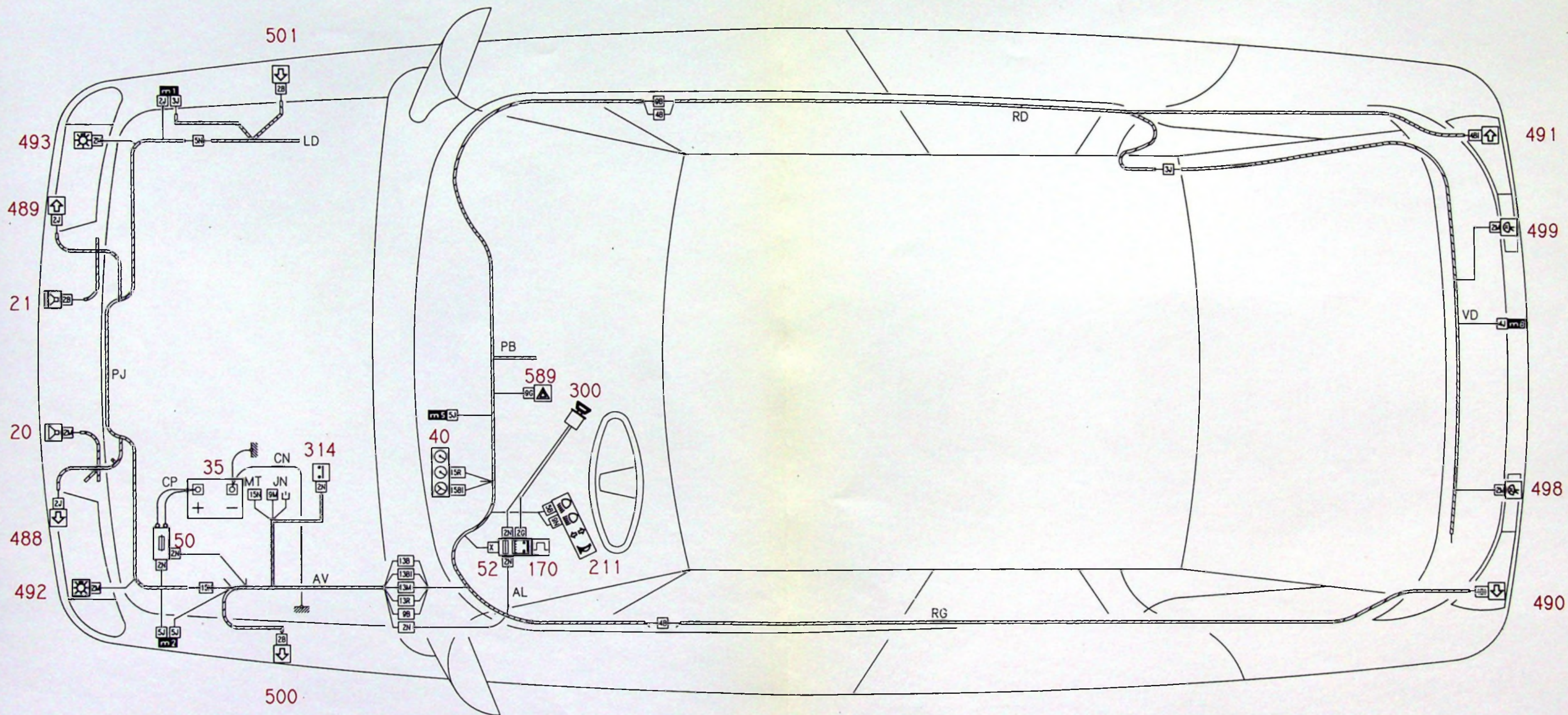



54

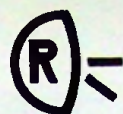
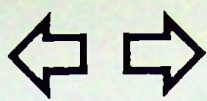

XM
542-00/10

3

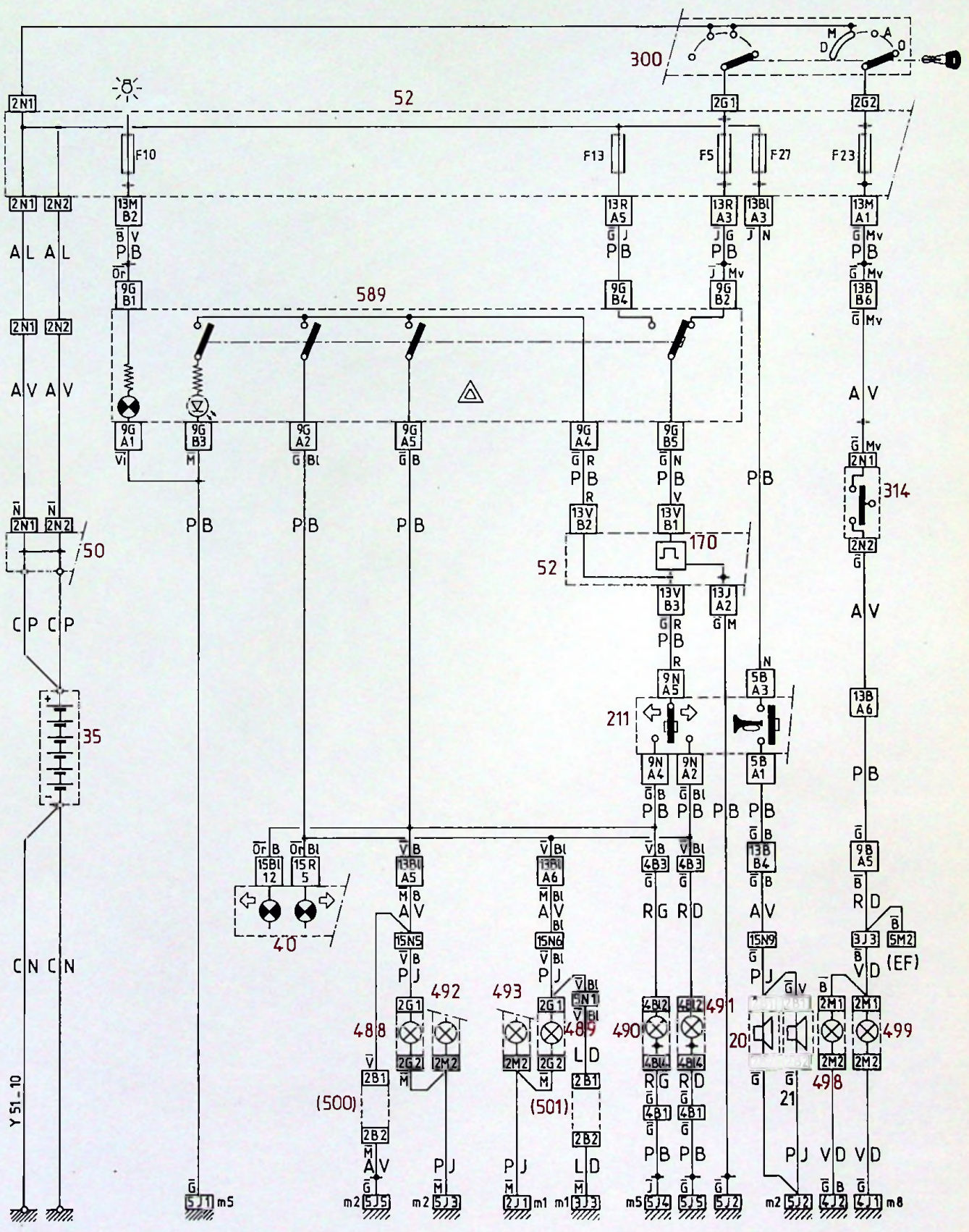

1 2 3 4 5 6 7 8 9 10 11 12 13 14 15 16 17 18 19 20 21 22 23 24 25 26



54

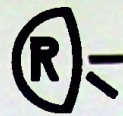
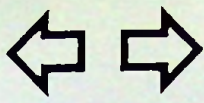

XM
542-00/10

5

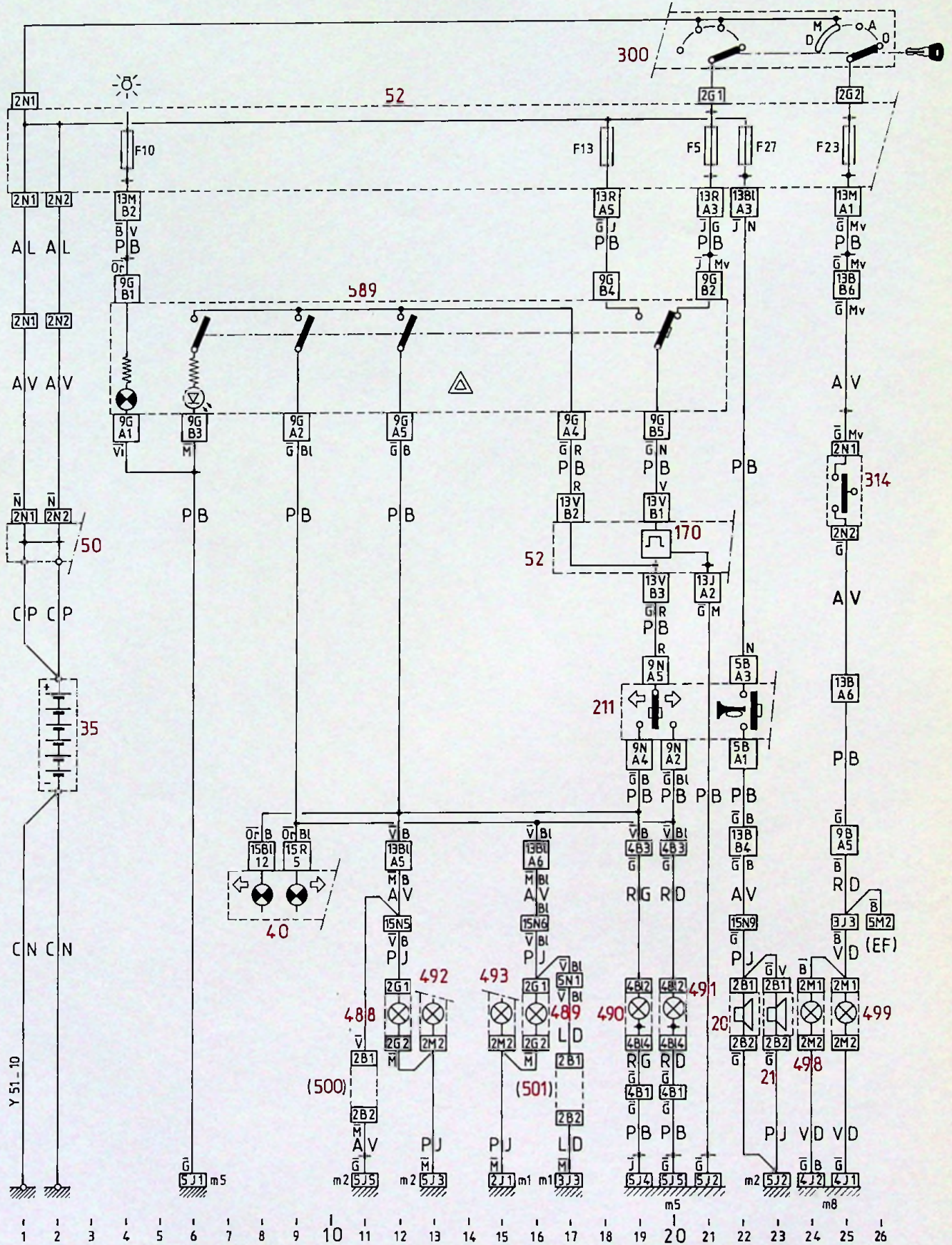



54

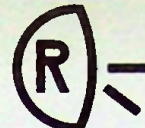
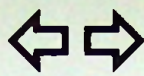

XM
542-00/10a

5

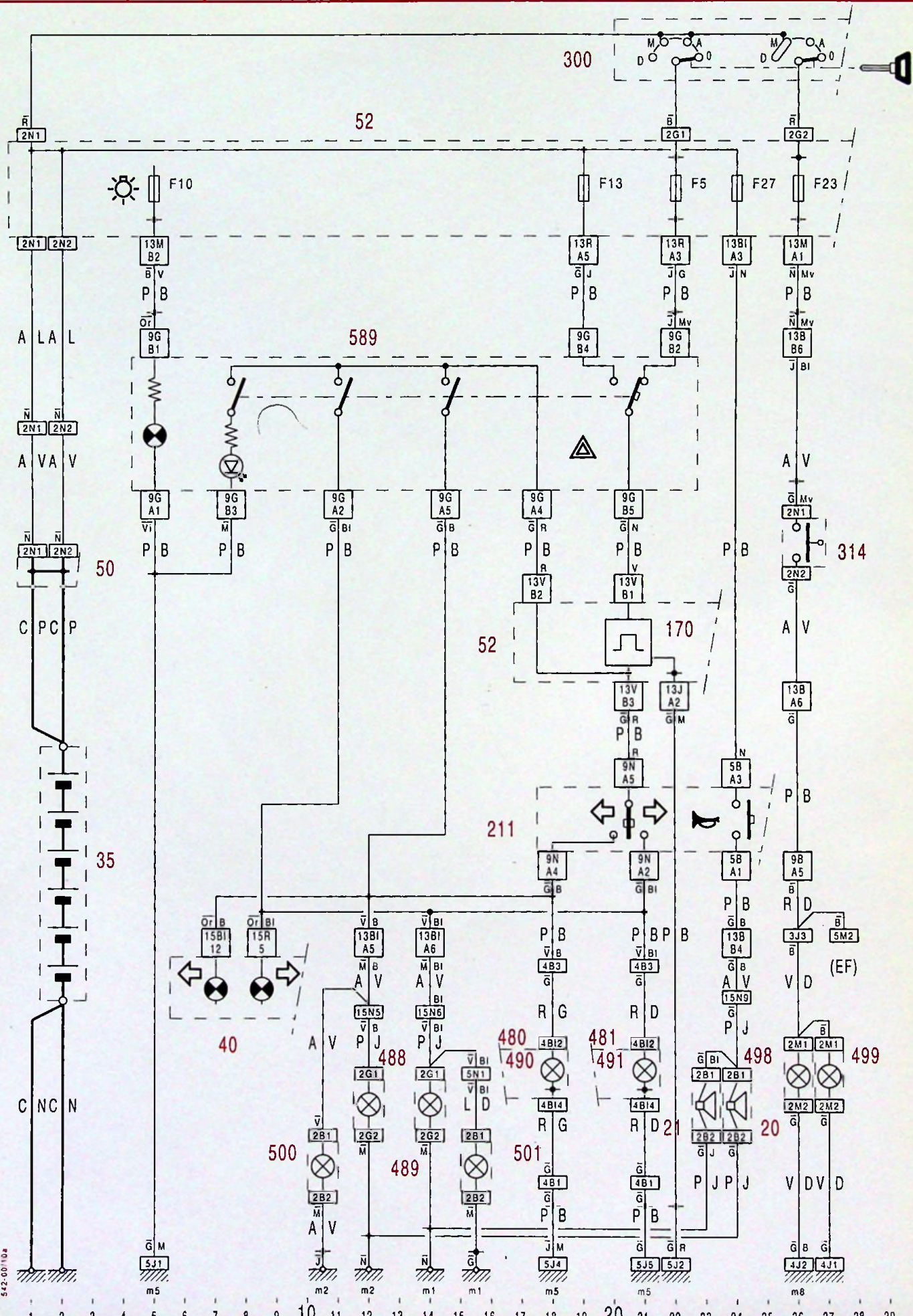



54

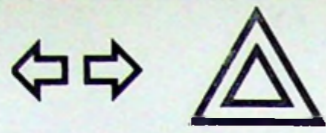

XM
542-0/11

3

4

XM
542-0/11

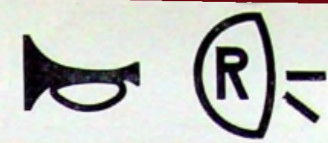

54

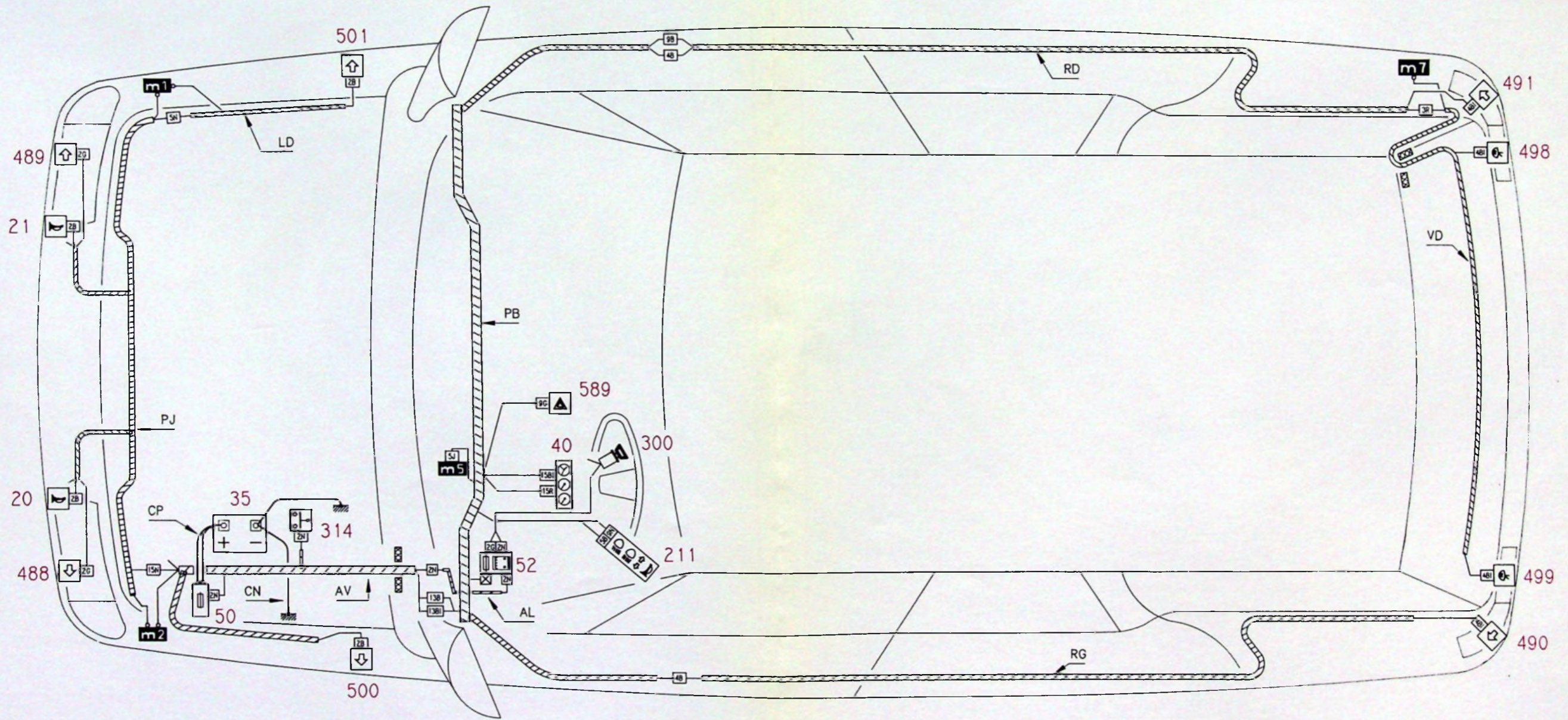



54

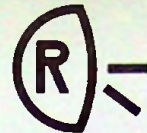

XM
542-0/11

5

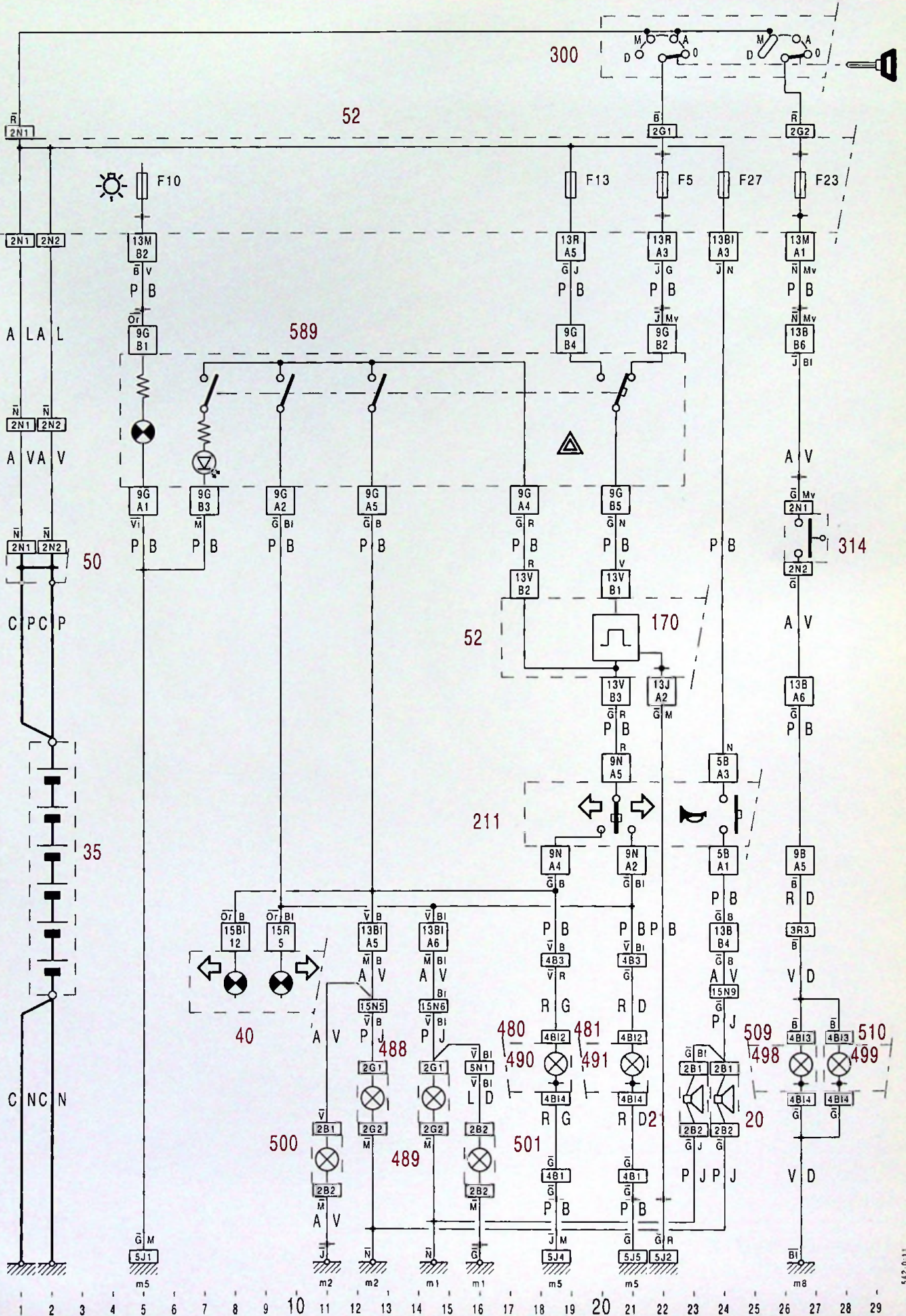



54

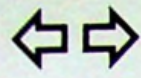

XM
542-0/31

3

4

XM
542-0/31

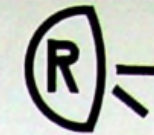

54

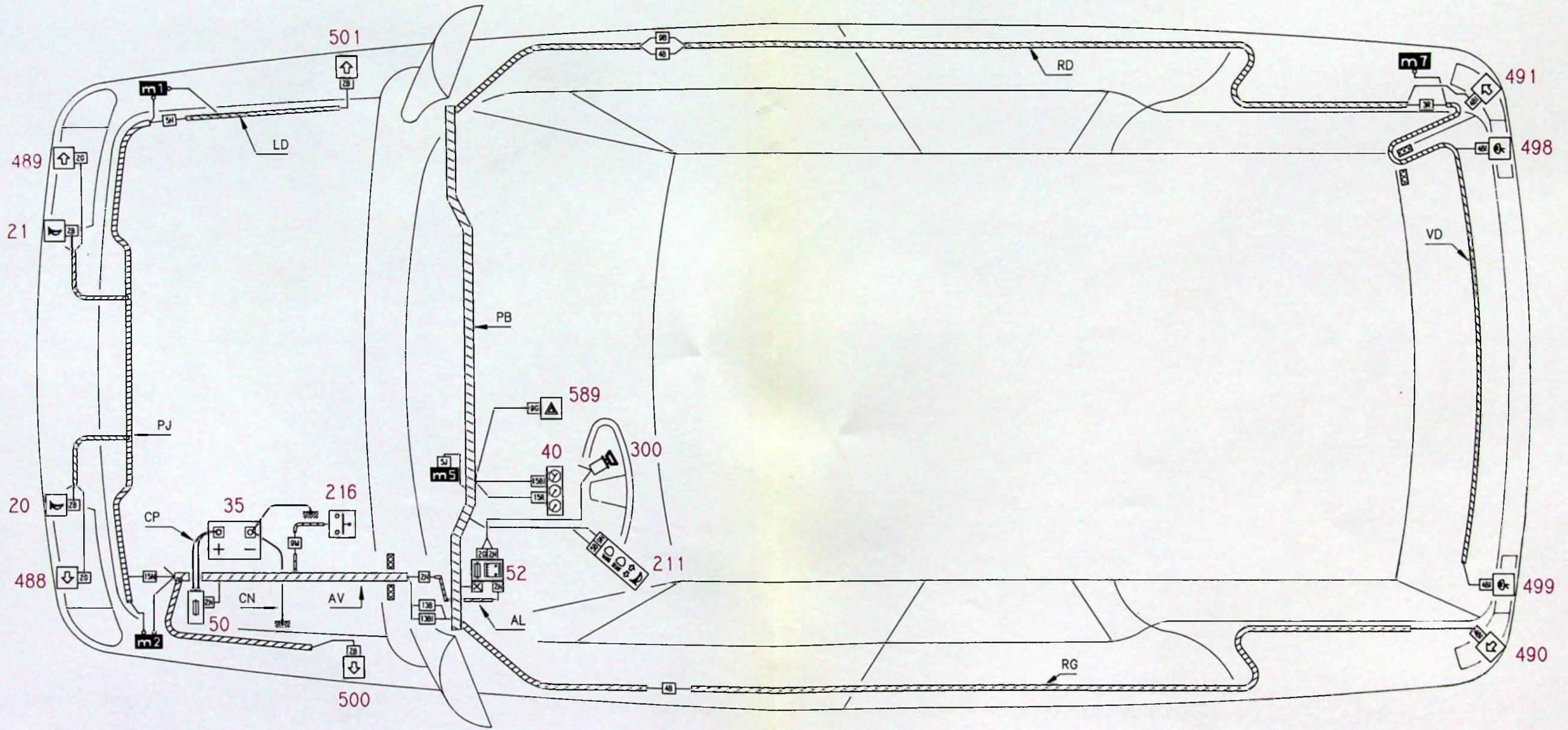



54



XM
542-0/31

5

