

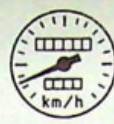

52



XM
520-000/1

1

FONCTION : TABLEAU DE BORD

LISTE DES SCHEMAS



BLOC COMPTEUR

NUMERO	DIRECTION	VALIDITE	DESIGNATION
521-0/10	Gauche	05/89 →	BLOC COMPTEUR - VEHICULE TOUS TYPES
521-1/10	Gauche	05/89 →	INDICATEUR et TEMOIN TEMPERATURE D'EAU VEHICULE NON REFRI
521-1/20	Gauche	05/89 →	INDICATEUR et TEMOIN TEMPERATURE D'EAU VEHICULE REFRI
521-1/30	Gauche	10/92 →	INDICATEUR et TEMOINS DE TEMPERATURE et DE NIVEAU D'HUILE
521-1/30a	Gauche	→ 10/92 07/93 →	Evolution a : modification des interconnexions entre faisceaux PB et AV.

PUPITRE DE CONTROLE ET AFFICHEUR GAUCHE

NUMERO	DIRECTION	VALIDITE	DESIGNATION
522-0/10	Gauche	→ 10/92	AFFICHEUR CENTRAL, MONTRE DIGITALE, SILHOUETTE AUTO
522-0/10a	Gauche	10/92 →	Evolution a : modification des interconnexions entre faisceaux PB et AV.
522-1/10	Gauche	→ 10/92	AFFICHEUR CENTRAL et MATRICE DE POINTS
522-1/10a	Gauche	10/92 →	Evolution a : modification des interconnexions entre faisceaux PB et AV.



52



XM
520-000/1

3

ORDINATEUR DE BORD

NUMERO	DIRECTION	VALIDITE	DESIGNATION
523-0/10	Gauche	05/89 →	XM TT

VOYANT SURCHAUFFE POT CATALYTIQUE

NUMERO	DIRECTION	VALIDITE	DESIGNATION
524-0/10	Gauche	05/89 →	JAPON



52

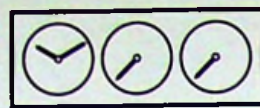

XM
521-0/10

3

4

XM
521-0/10

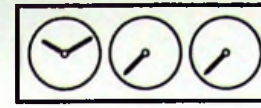

52

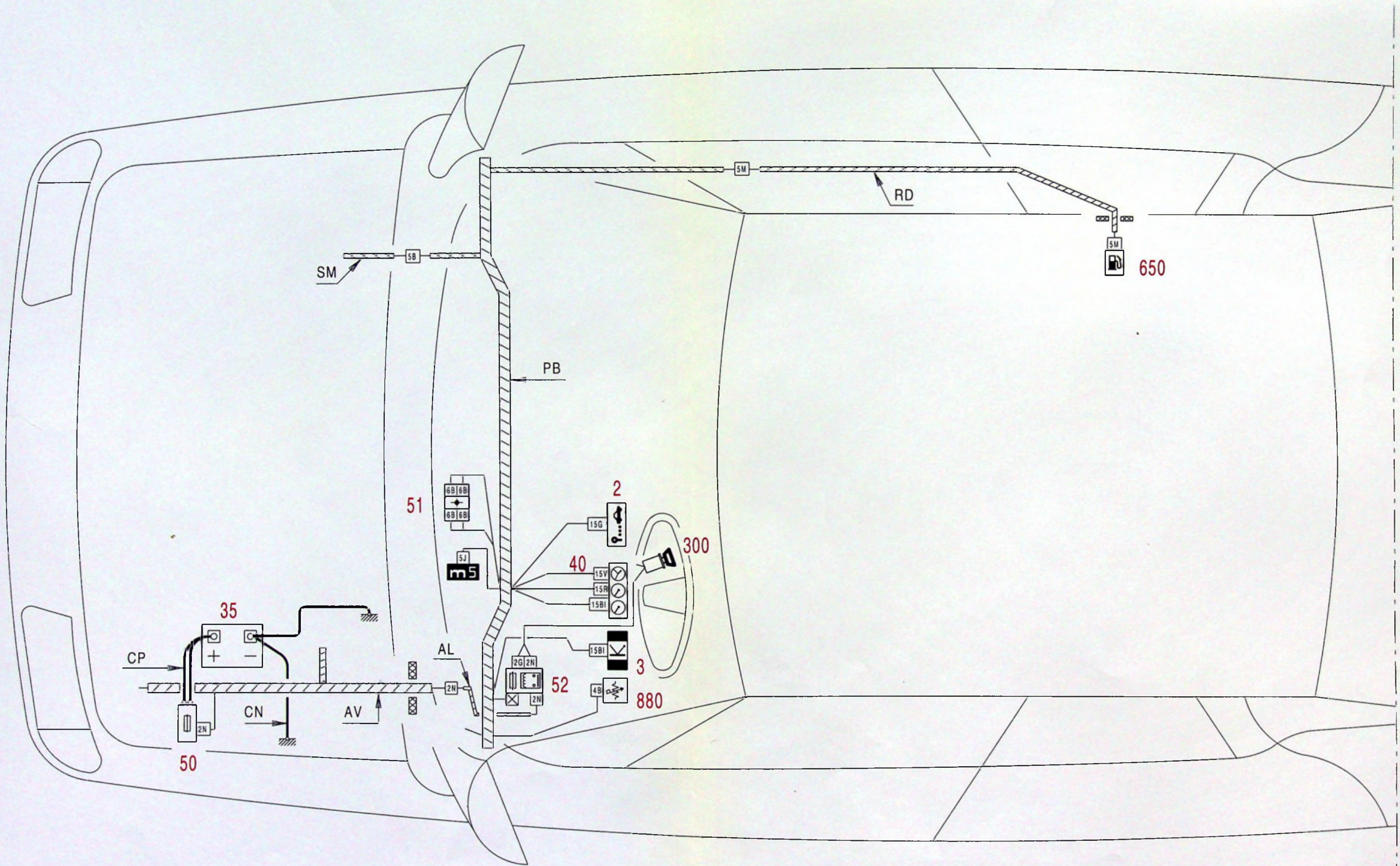



52

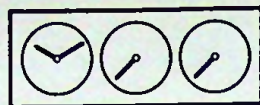

XM
521-0/10

6

7

XM
521-0/10



52

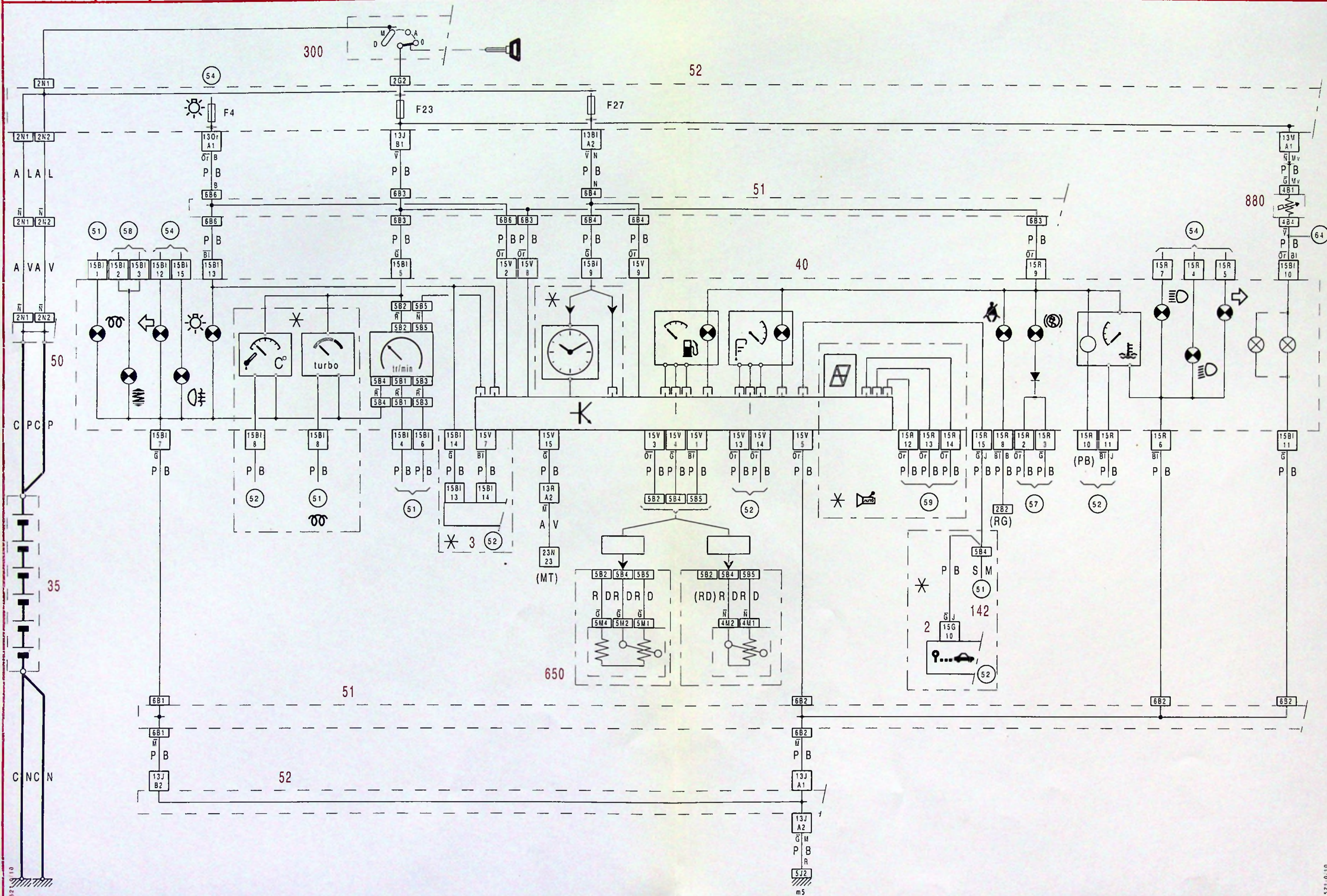

1 2 3 4 5 6 7 8 9 10 11 12 13 14 15 16 17 18 19 20 21 22 23 24 25 26 27 28 29 30 31 32 33 34 35 36 37 38 39 40 41 42 43 44 45 46 47 48 49 50 51 52 53 54 55 56 57 58 59 60 61 62

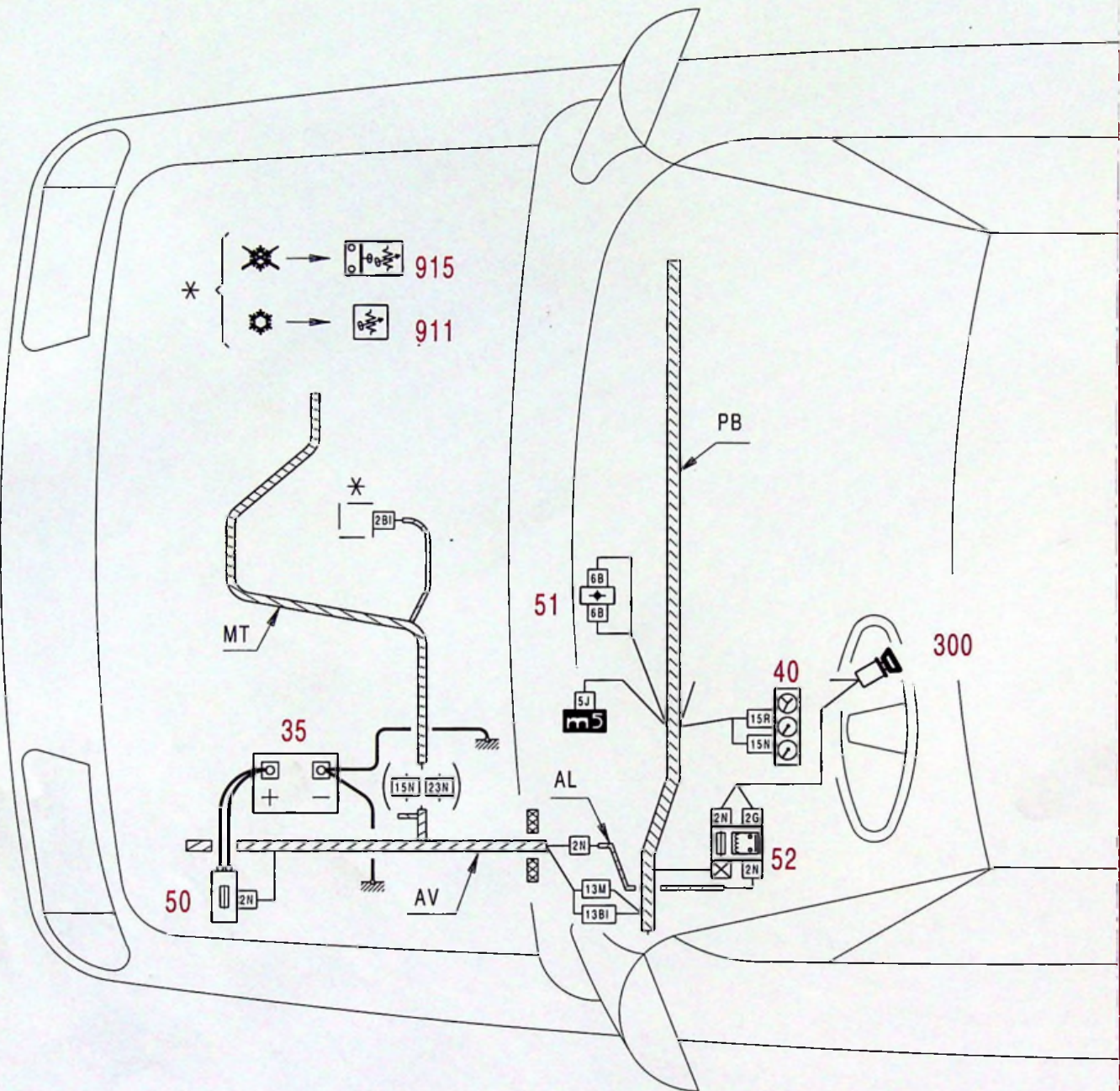



52



XM
521-1/20

3

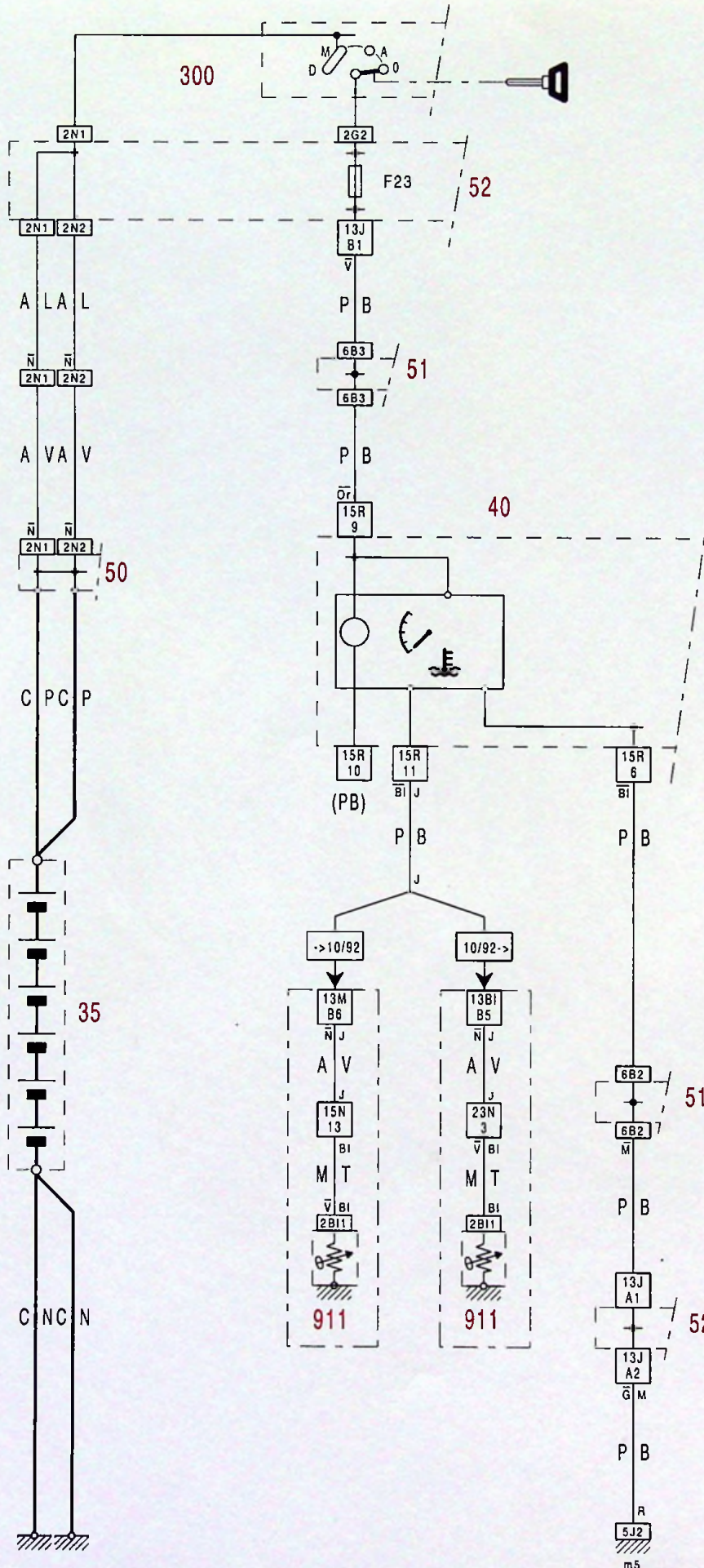

521-1/20

1 2 3 4 5 6 7 8 9 10 11 12 13 14 15 16 17 18 19 20 21 22 23 24 25 26 27 28 29

521-1/20

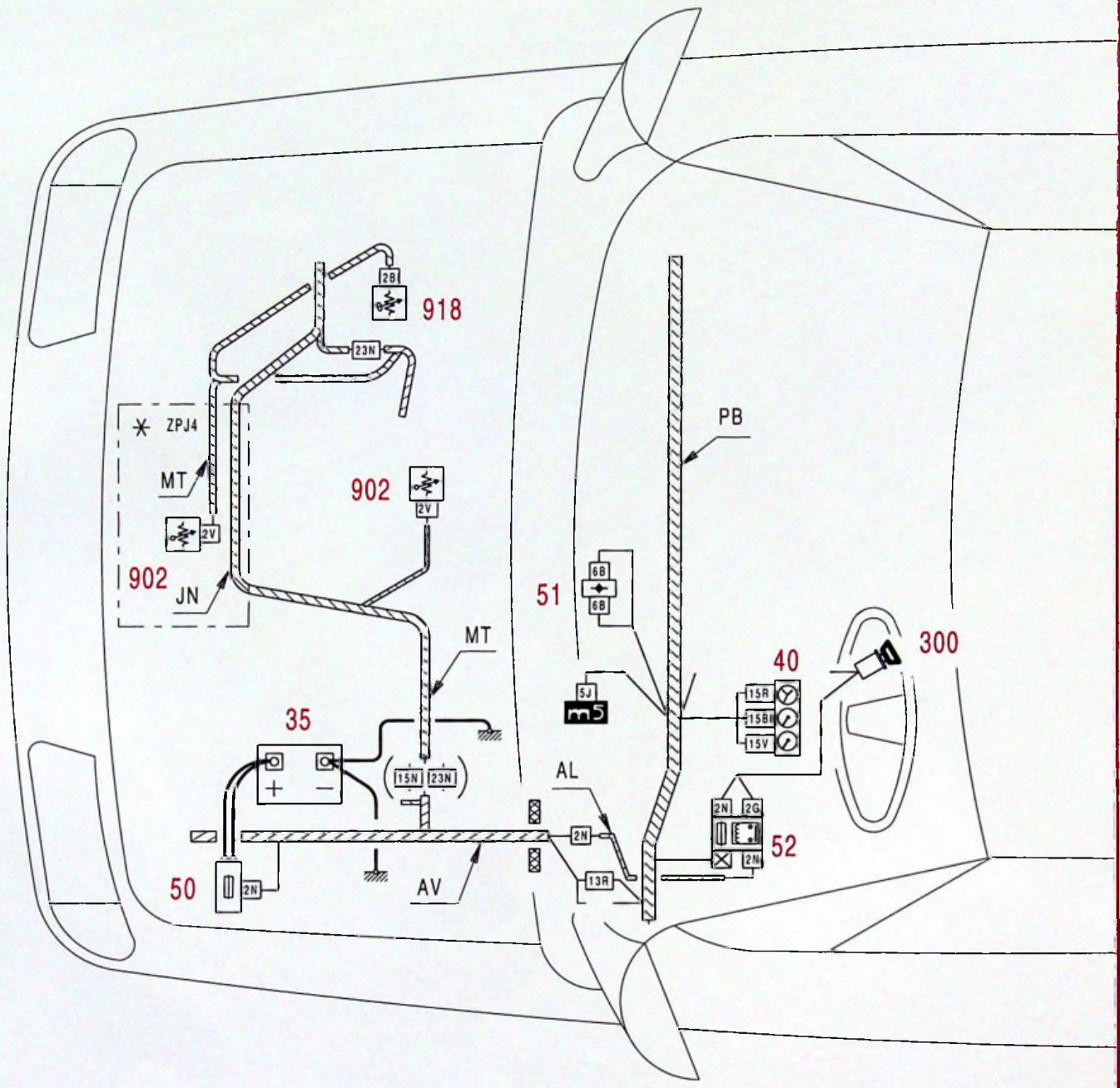



52



XM
521-1/30

3

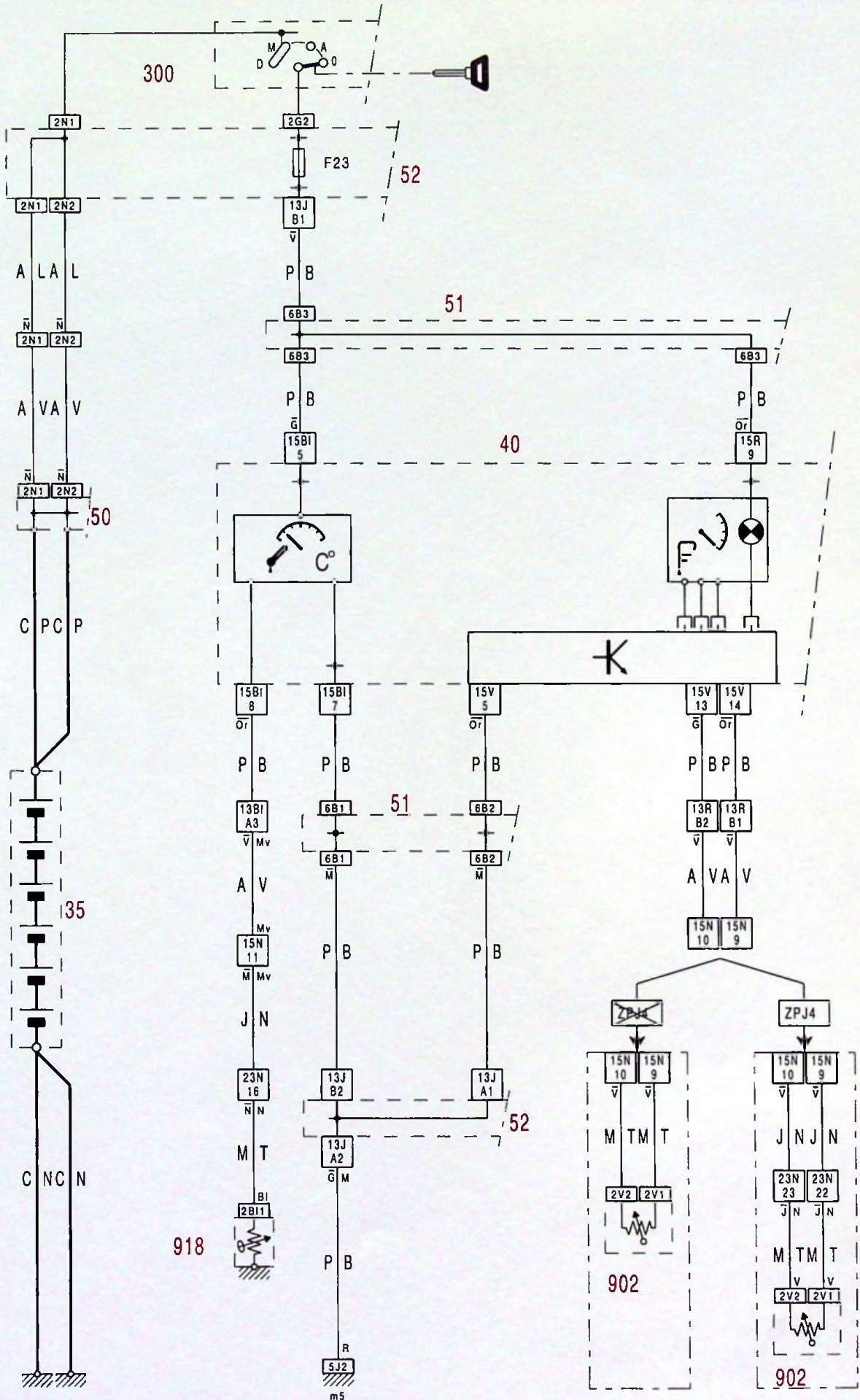

521-1/30

521-1/30

1 2 3 4 5 6 7 8 9 10 11 12 13 14 15 16 17 18 19 20 21 22 23 24 25 26 27 28 29

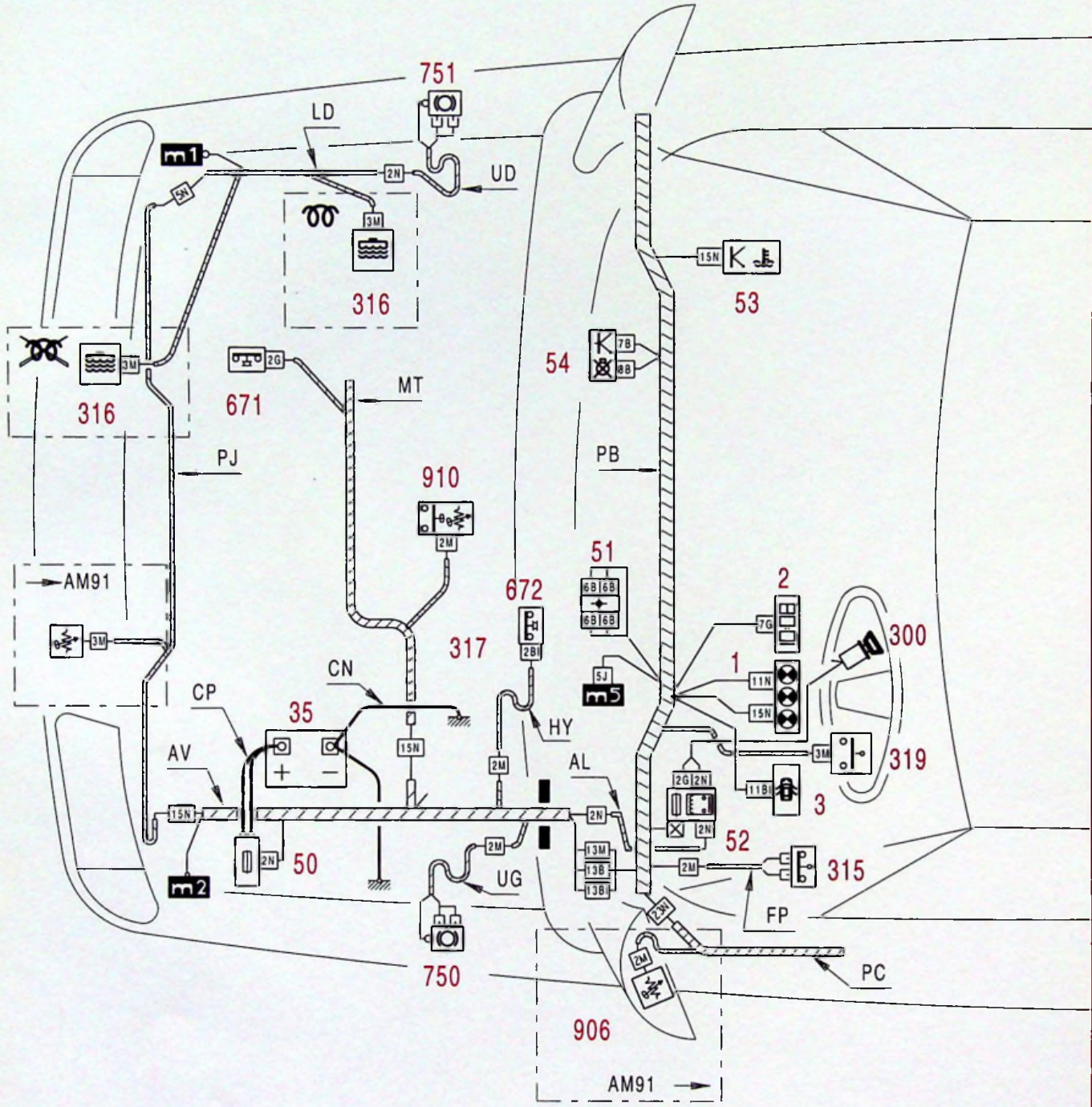
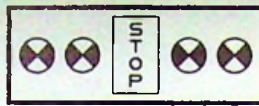



52



XM
522-0/10

4

5

XM
522-0/10

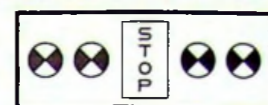

52

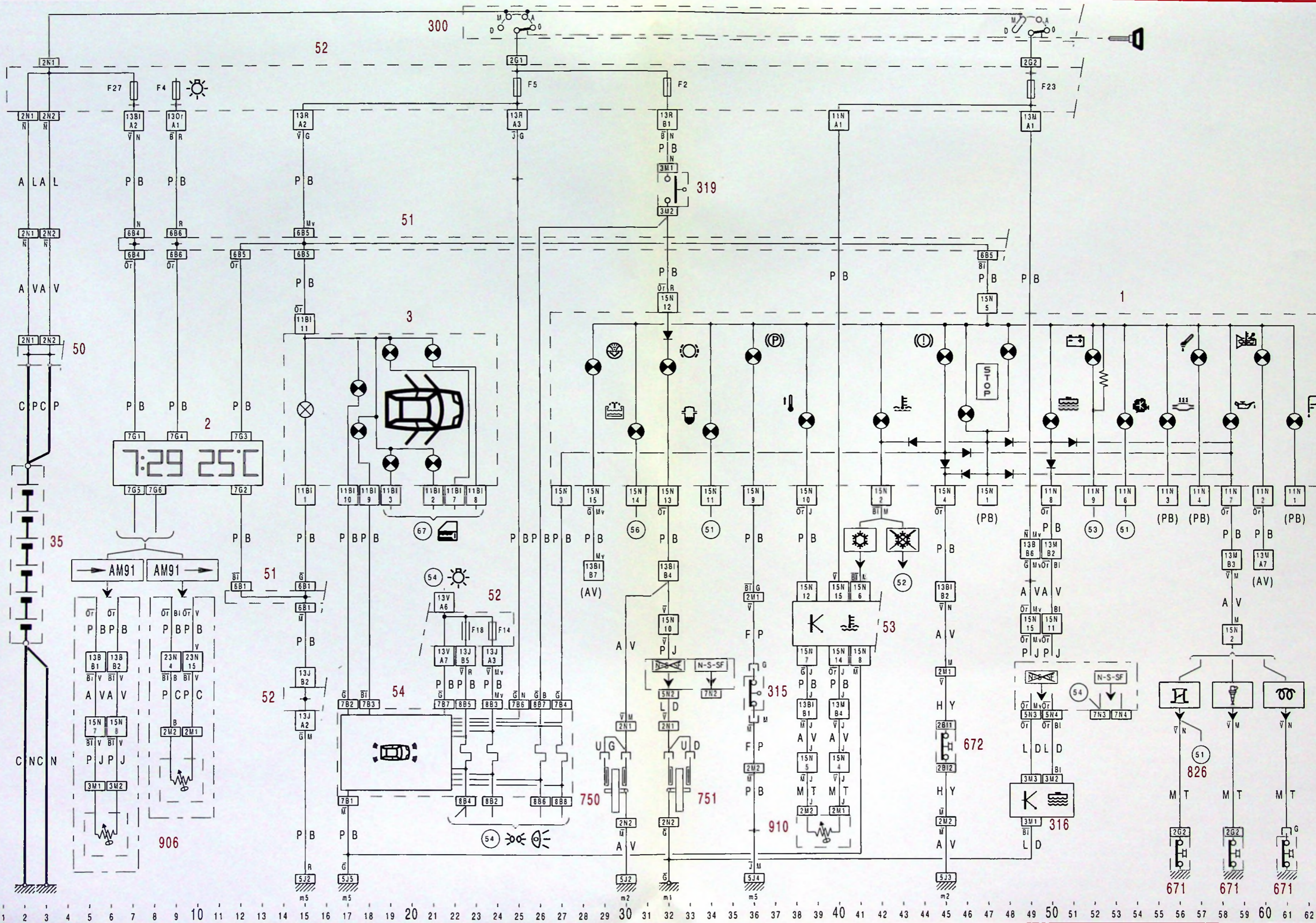

522-0/10

522-0/10



52

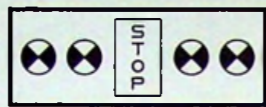

XM
522-1/10

4

5

XM
522-1/10

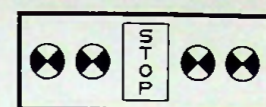

52

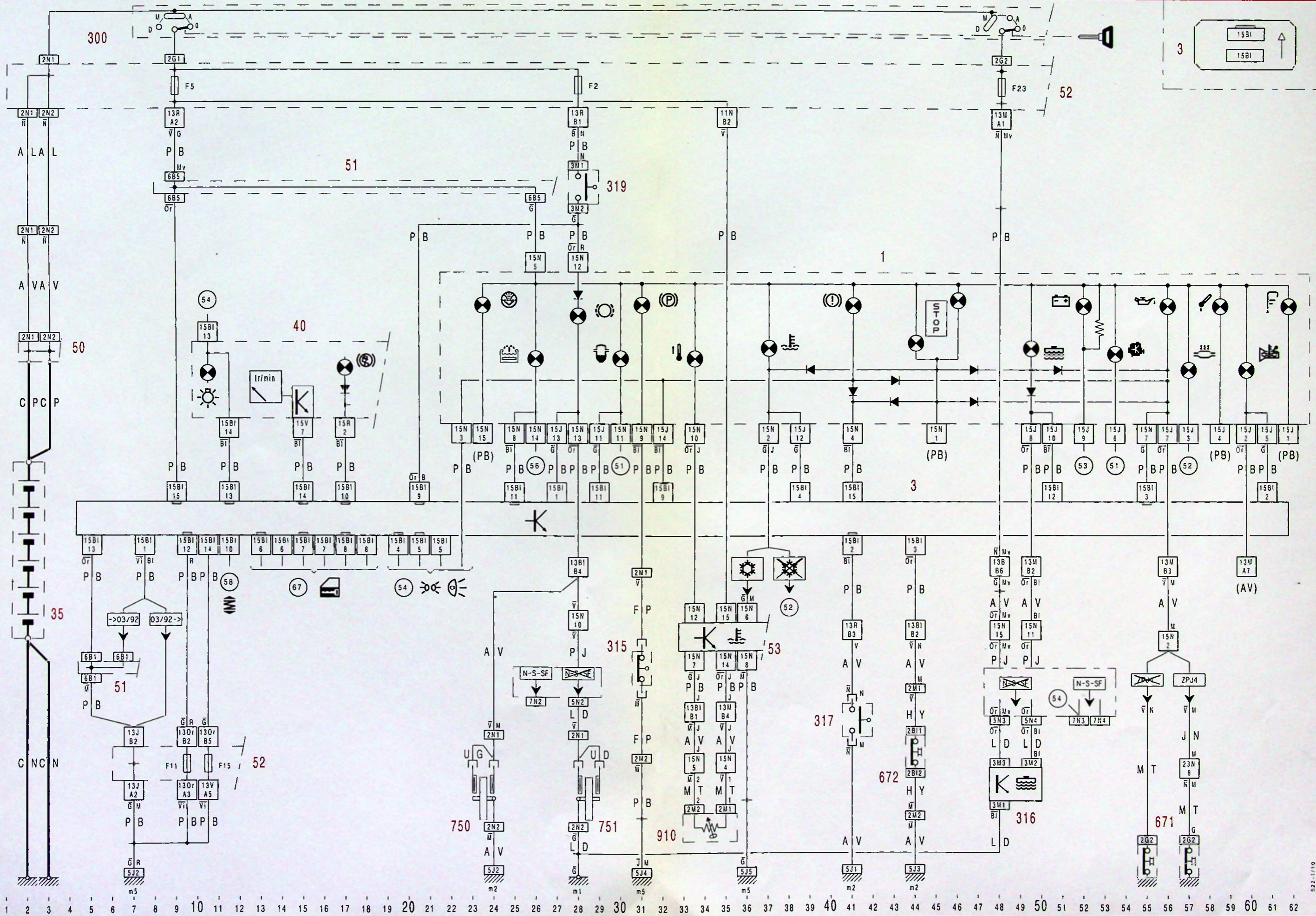

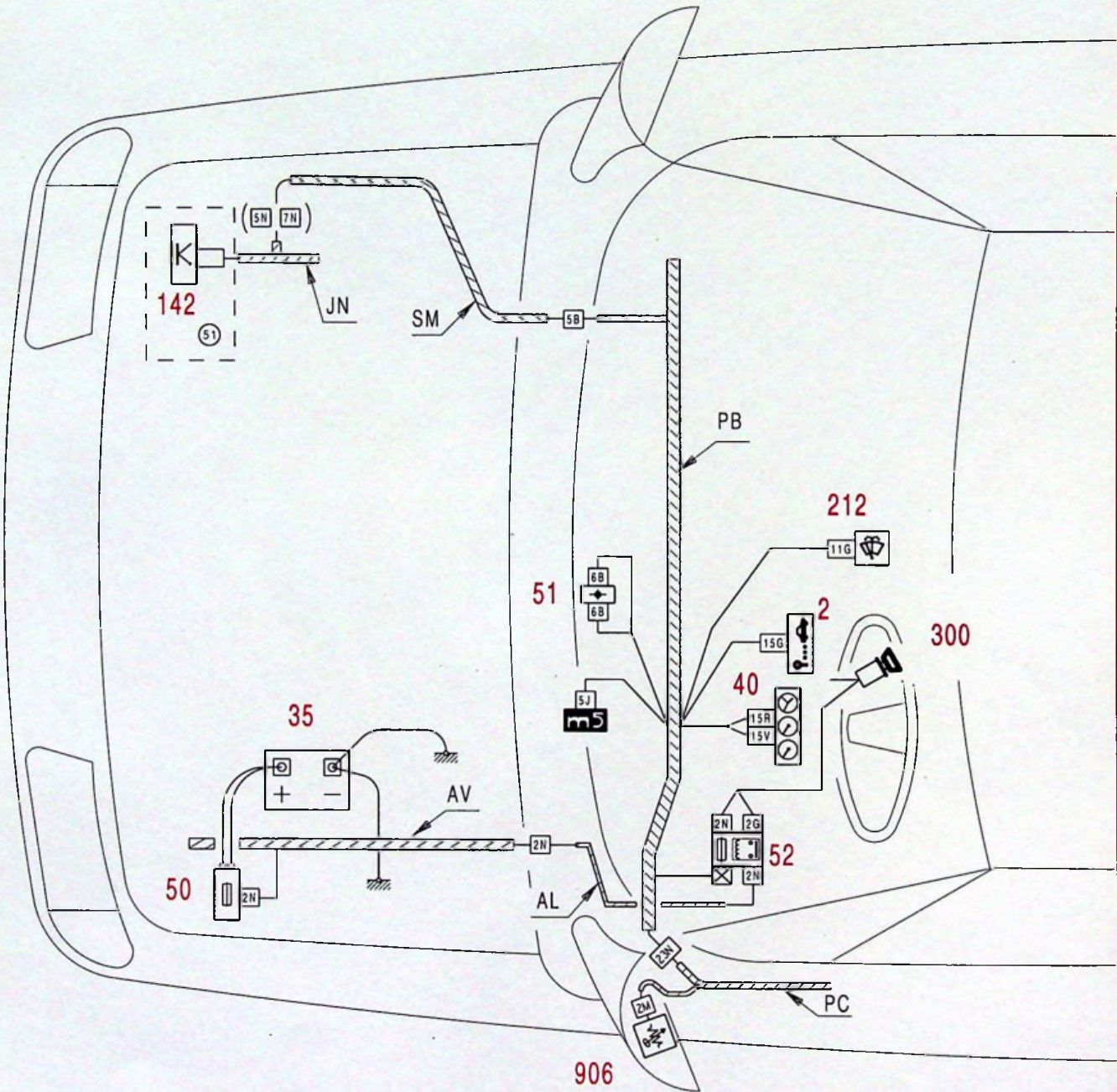



52

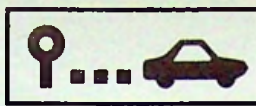

XM
523-0/10

3

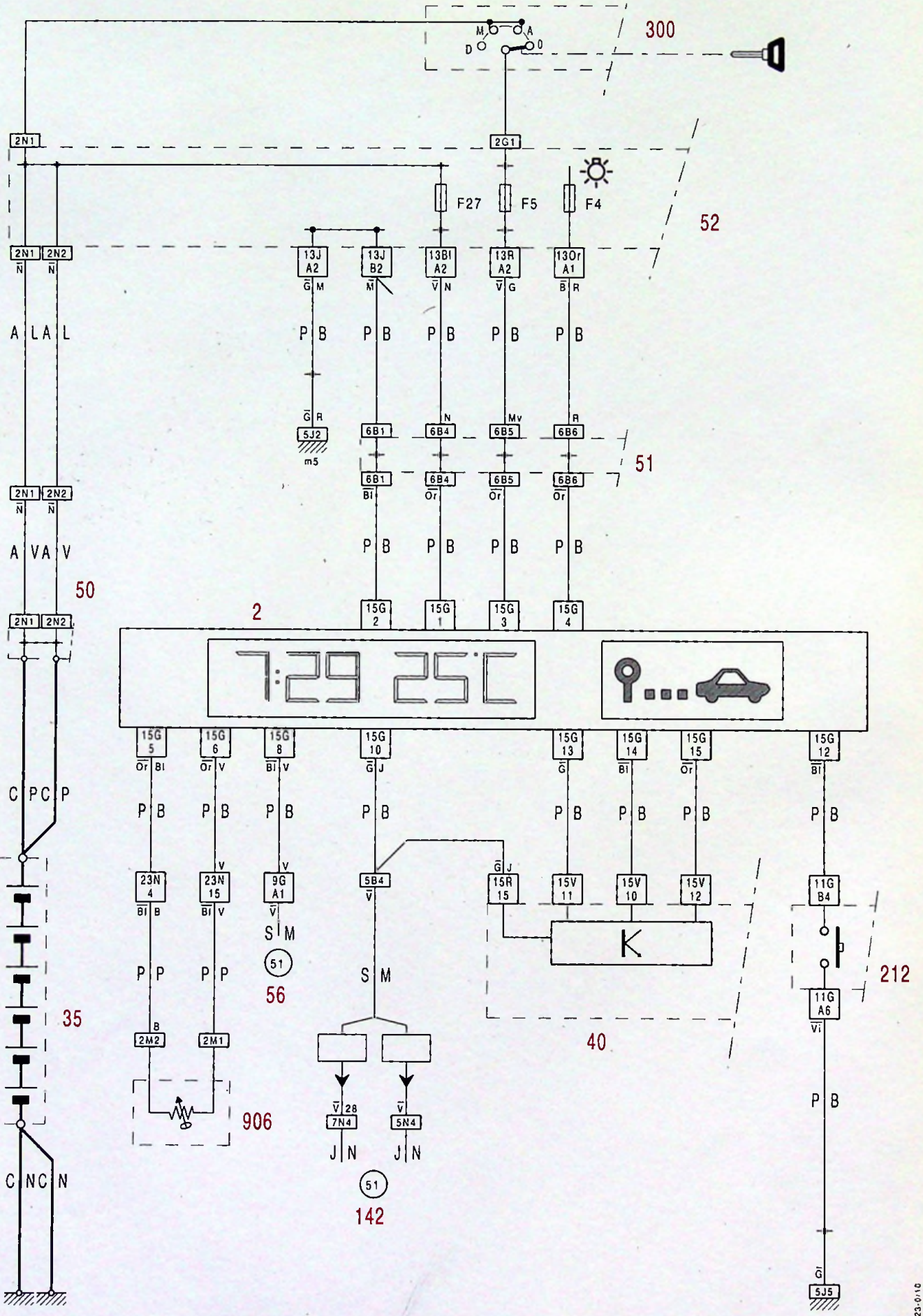

523-0/10

523-0/10

1 2 3 4 5 6 7 8 9 10 11 12 13 14 15 16 17 18 19 20 21 22 23 24 25 26 27 28 29



52



XM
524-0/10

3

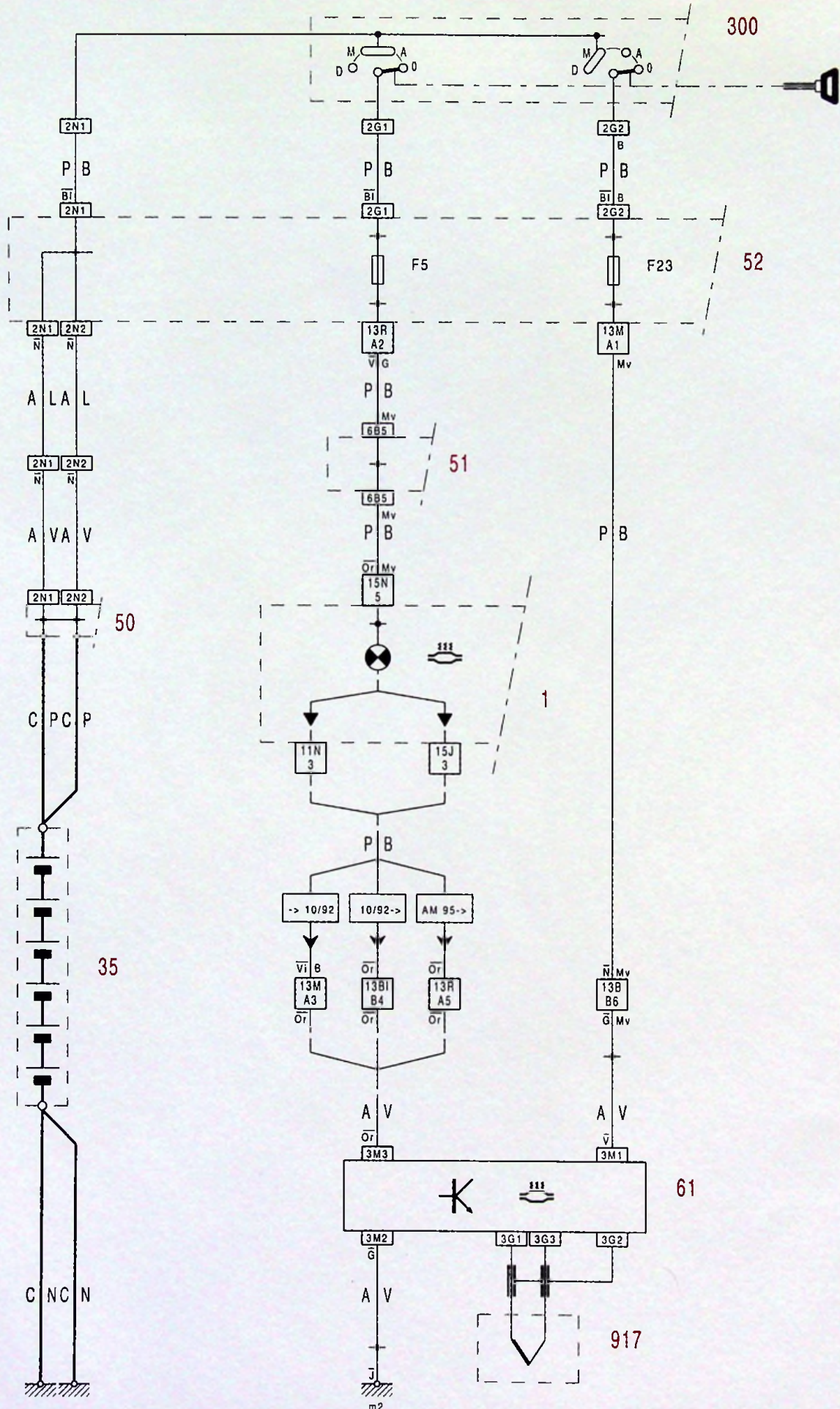

524-0/10

524-0/10

1 2 3 4 5 6 7 8 9 10 11 12 13 14 15 16 17 18 19 20 21 22 23 24 25 26 27 28 29



52



XM
520-000/1

1

Anciens Schémas

conservés pour information

(la décomposition des schémas a permis de simplifier et de diminuer leur nombre)

FONCTION TABLEAU DE BORD

LISTE DES SCHEMAS



BLOC COMPTEUR

NUMÉRO	DIRECTION	VALIDITÉ	DÉSIGNATION
521-0/10	Gauche	09/89 -- > -- > 07/91	VÉHICULE SANS AFFICHEUR GAUCHE
521-0/10a	Gauche	-- > 07/91	Évolution a : Présence d'un compte-tours.
521-0/20	Gauche	09/89 -- >	XM Diesel atmosphérique avec afficheur gauche
521-0/21	Gauche	05/89 -- >	XM 4 Cyl Inj avec afficheur gauche
521-0/22	Gauche	11/89 -- > -- > 06/91	XM Diesel Turbo avec afficheur gauche
521-0/22a	Gauche	06/91 -- >	Évolution masse faisceau AV Option BVA
521-0/30	Gauche	11/89 -- >	XM 6 Cyl Sauf 24 S
521-0/40	Gauche	07/90 -- >	XM 6 Cyl 24 S

AFFICHEUR CENTRAL

NUMÉRO	DIRECTION	VALIDITÉ	DÉSIGNATION
522-0/10	Gauche	05/89 -- > -- > 07/91	VÉHICULE SANS AFFICHEUR GAUCHE Sans REFRI
522-0/10a	Gauche	-- > 07/91	Évolution a : Présence d'un compte-tours
522-0/11	Gauche	05/90 -- > -- > 07/91	VÉHICULE SANS AFFICHEUR GAUCHE Avec REFRI
522-0/11a	Gauche	07/91 -- >	Évolution a : Présence d'un compte-tours



52

XM
520-000/1

3

522-0/20	Gauche	05/89 -- > -- > 07/91	VÉHICULE AVEC SILHOUETTE AUTO Sans REFRI
	Gauche	7/91 -- >	Évolution a : Modif. masse m2 faisceau AV
522-0/21	Gauche	05/89 -- >	VÉHICULE AVEC SILHOUETTE AUTO Avec REFRI
522-0/30	Gauche	05/89 -- > -- > 03/92	VÉHICULE AVEC MATRICE DE POINTS Sans REFRI
522-0/30a	Gauche	03/92 -- >	Évolution a : Modif. masse matrice de points
522-0/31	Gauche	05/89 -- > -- > 03/92	VÉHICULE AVEC MATRICE DE POINTS Avec REFRI
522-0/31a	Gauche	03/92 -- >	Évolution a : Modif. masse matrice de points
522-1/10	Gauche	07/89 -- > -- > 07/91	VÉHICULE AVEC MATRICE DE POINTS Sans REFRI (N-S-SF)
522-1/10a	Gauche	07/91 -- >	Évolution a : Modif. masse m2 faisceau AV
522-1/11	Gauche	07/89 -- > -- > 07/91	VÉHICULE SANS AFFICHEUR GAUCHE Avec REFRI (N - S - SF)
522-1/11a	Gauche	07/91 -- >	Évolution a : Modif. masse m2 faisceau AV
522-1/20	Gauche	07/89 -- >	VÉHICULE AVEC SILHOUETTE AUTO Sans REFRI (N - S - SF)
522-1/21	Gauche	07/89 -- > -- > 07/91	VÉHICULE AVEC SILHOUETTE AUTO Avec REFRI (N - S - SF)
522-1/21a	Gauche	07/91 -- >	Évolution a : Modif. masse m2 faisceau AV
522-1/30	Gauche	07/89 -- > -- > 03/92	VÉHICULE AVEC MATRICE DE POINTS Sans REFRI (N - S - SF)
522-1/30a	Gauche	03/92 -- >	Évolution a : Modif. masse matrice de points



AFFICHEUR CENTRAL

NUMÉRO	DIRECTION	VALIDITÉ	DÉSIGNATION
522-1/31	Gauche	07/89-- > -- > 03/92	VÉHICULE AVEC MATRICE DE POINTS Avec REFRI (N - S - SF) Évolution a : Modif. masse matrice de points
522-1/31a	Gauche	03/92 -- >	

VOYANT SURCHAUFFE POT CATALYTIQUE

523-1/20	Gauche		XM TT
523-2/20	Droite		XM TT

ORDINATEUR DE BORD

NUMÉRO	DIRECTION	VALIDITÉ	DÉSIGNATION
524-0/30	Gauche		VÉHICULE AVEC MATRICE DE POINTS



52

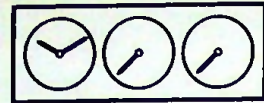

XM
521-0/10a

6

7

XM
521-0/10a

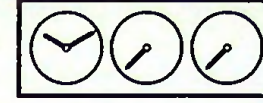

52

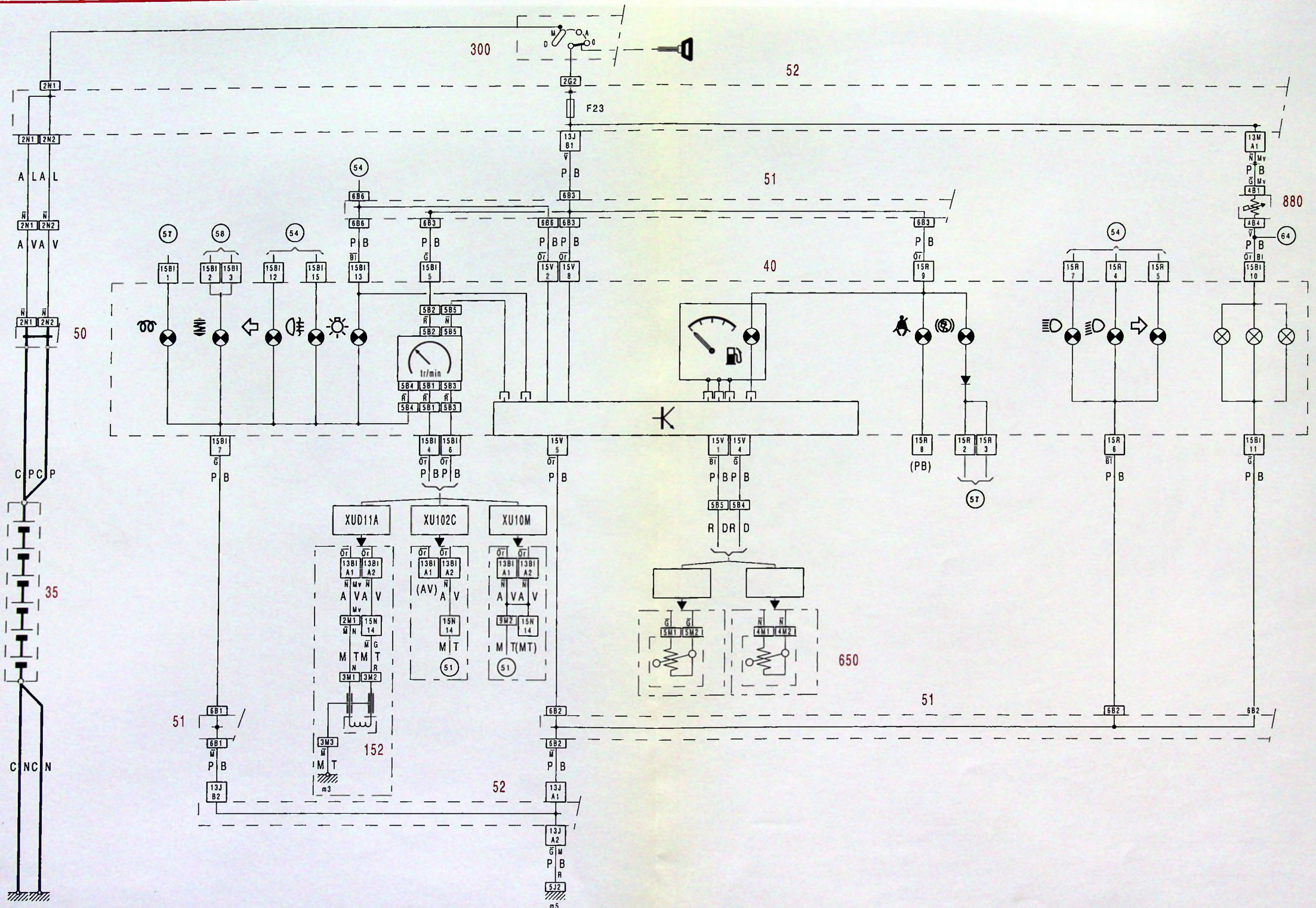

521-0/10a

1 2 3 4 5 6 7 8 9 10 11 12 13 14 15 16 17 18 19 20 21 22 23 24 25 26 27 28 29 30 31 32 33 34 35 36 37 38 39 40 41 42 43 44 45 46 47 48 49 50 51 52 53 54 55 56 57 58 59 60 61 62



52



XM
521-0/22a

6

7

XM
521-0/22a

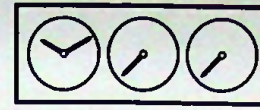

52

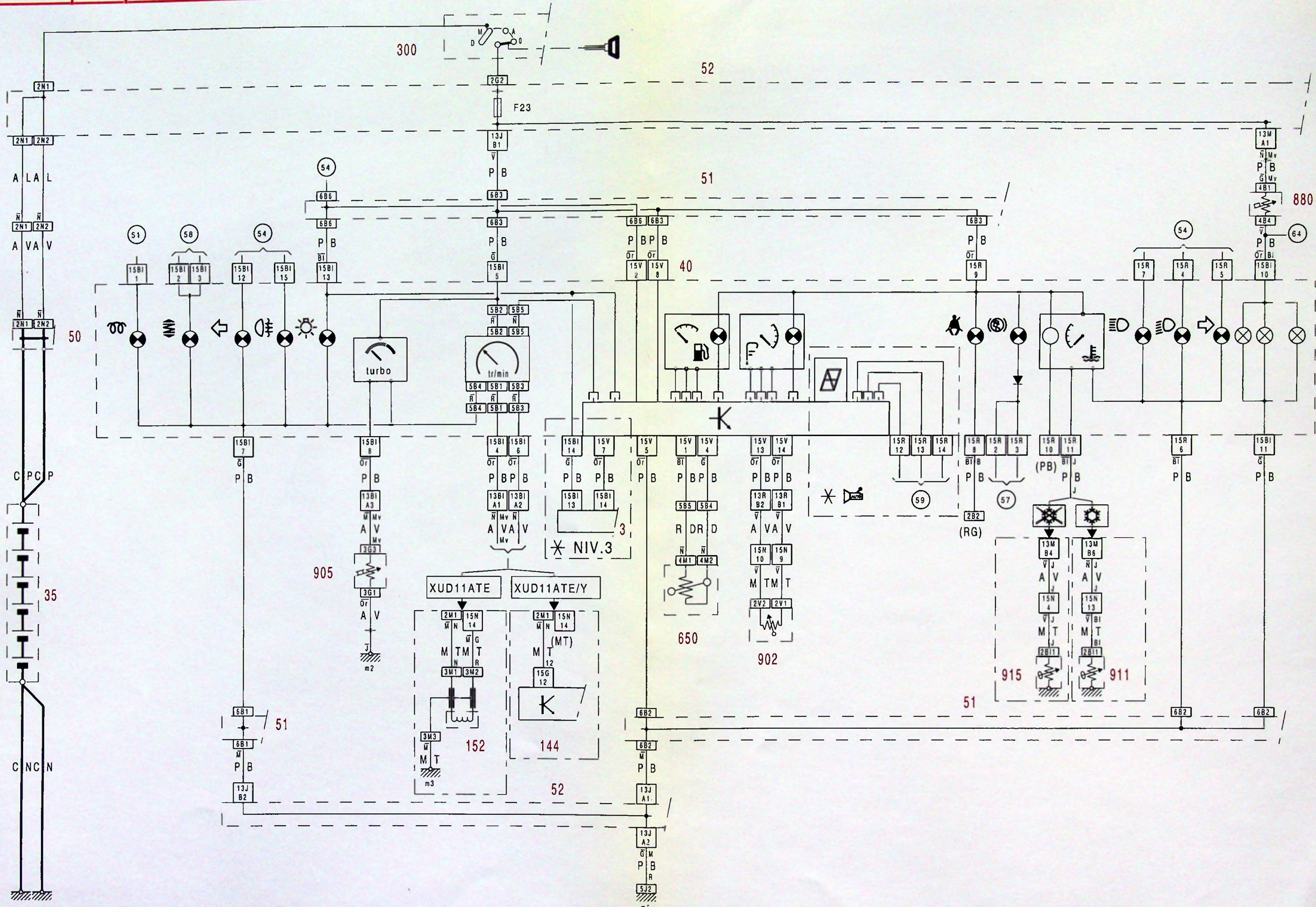

521-0/22a

1 2 3 4 5 6 7 8 9 10 11 12 13 14 15 16 17 18 19 20 21 22 23 24 25 26 27 28 29 30 31 32 33 34 35 36 37 38 39 40 41 42 43 44 45 46 47 48 49 50 51 52 53 54 55 56 57 58 59 60 61 62



52



XM
521-00/32

6

7

XM
521-00/32



52

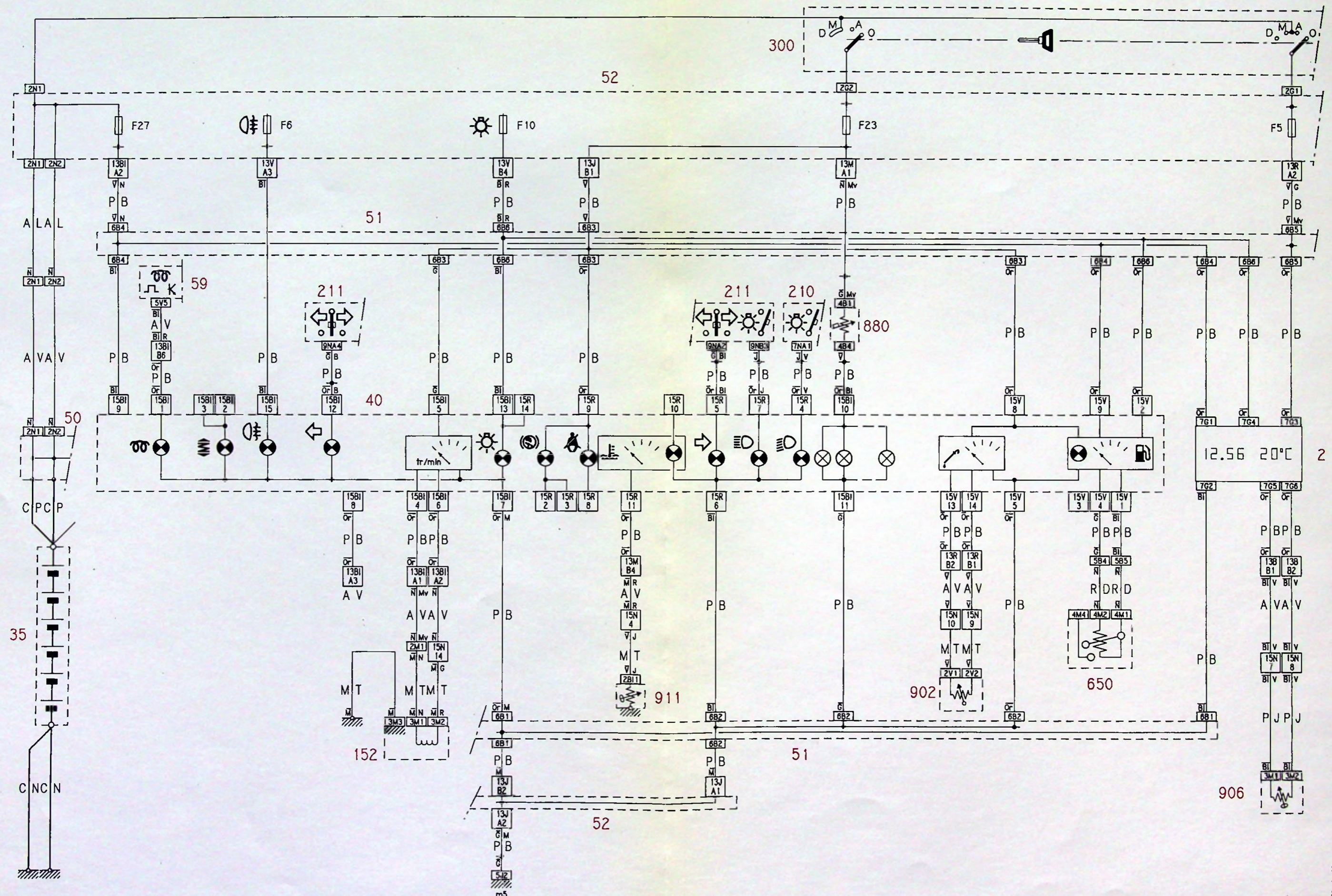

1 2 3 4 5 6 7 8 9 10 11 12 13 14 15 16 17 18 19 20 21 22 23 24 25 26 27 28 29 30 31 32 33 34 35 36 37 38 39 40 41 42 43 44 45 46 47 48 49 50 51 52 53 54 55 56 57 58 59 60 61 62



52

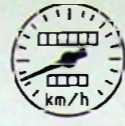

XM
521-00/40

6

7

XM
521-00/40



52

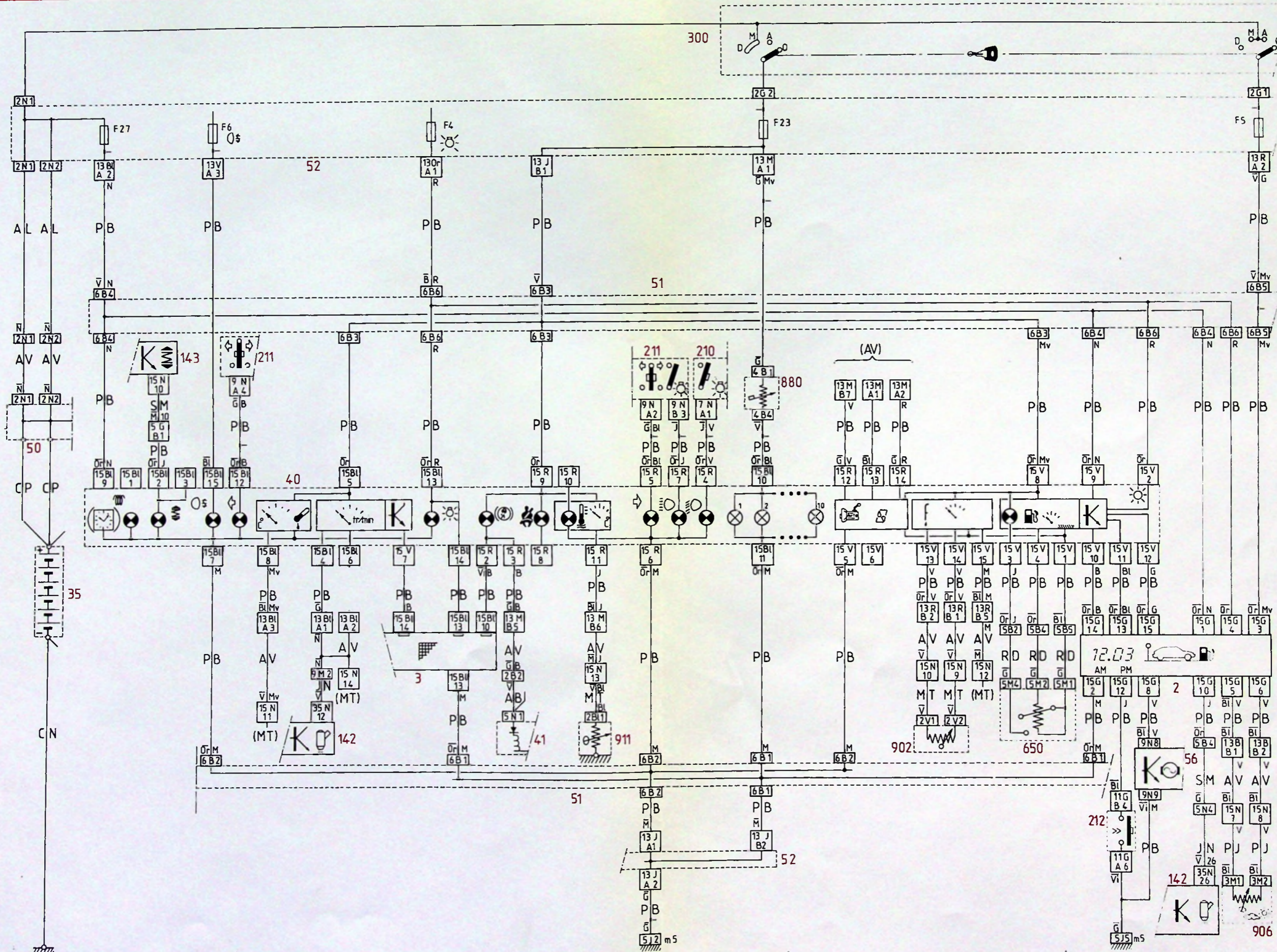

1 2 3 4 5 6 7 8 9 10 1 2 3 4 5 6 7 8 9 20 1 2 3 4 5 6 7 8 9 30 1 2 3 4 5 6 7 8 9 40 1 2 3 4 5 6 7 8 9 50

Y 51.32



52

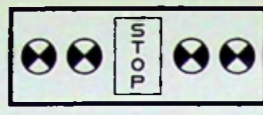

XM
522-0/10a

4

5

XM
522-0/10a

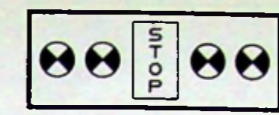

52

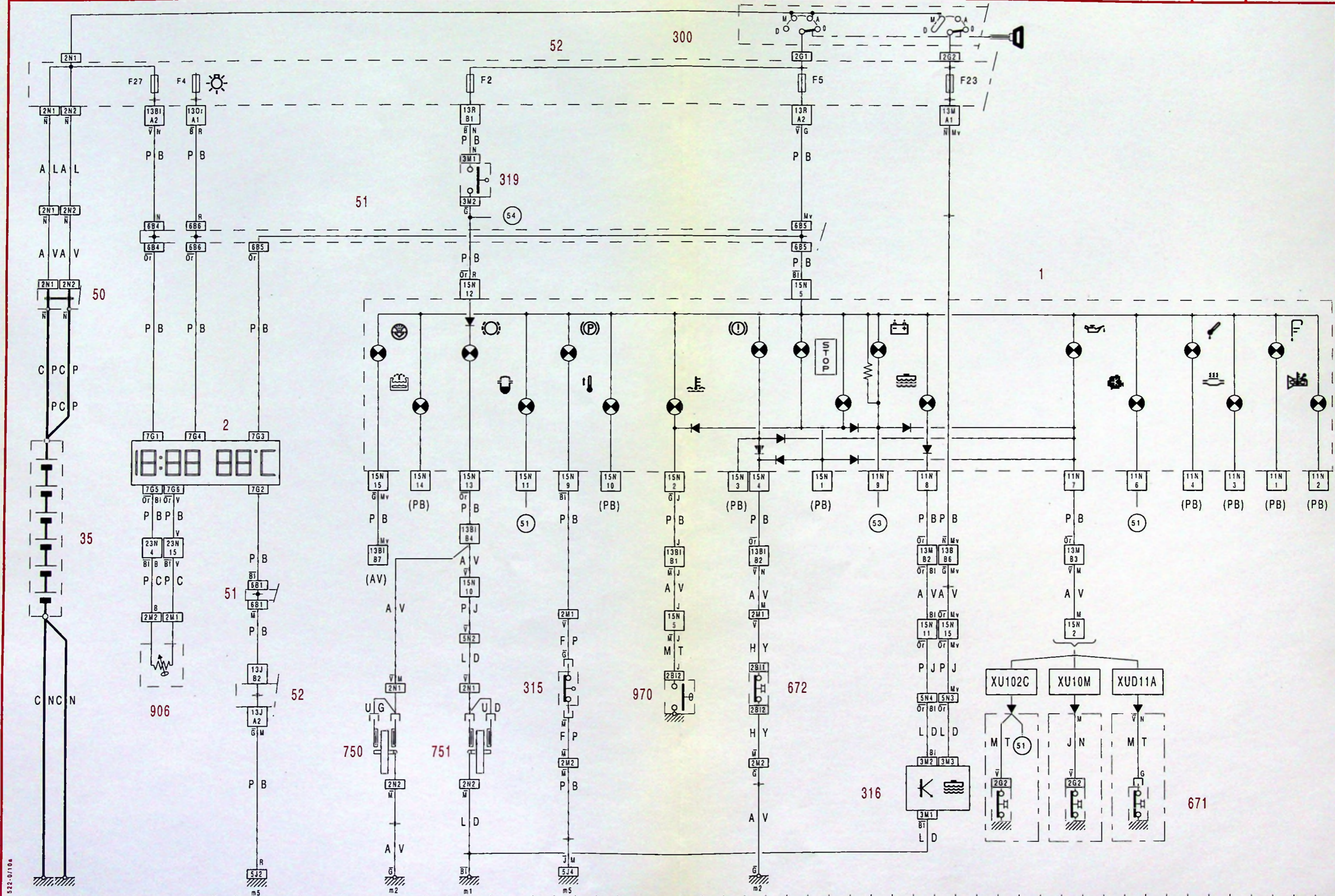

522-0/10a

1 2 3 4 5 6 7 8 9 10 11 12 13 14 15 16 17 18 19 20 21 22 23 24 25 26 27 28 29 30 31 32 33 34 35 36 37 38 39 40 41 42 43 44 45 46 47 48 49 50 51 52 53 54 55 56 57 58 59 60 61 62



52

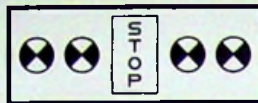

XM
522-0/11a

4

5

XM
522-0/11a



52



52 300

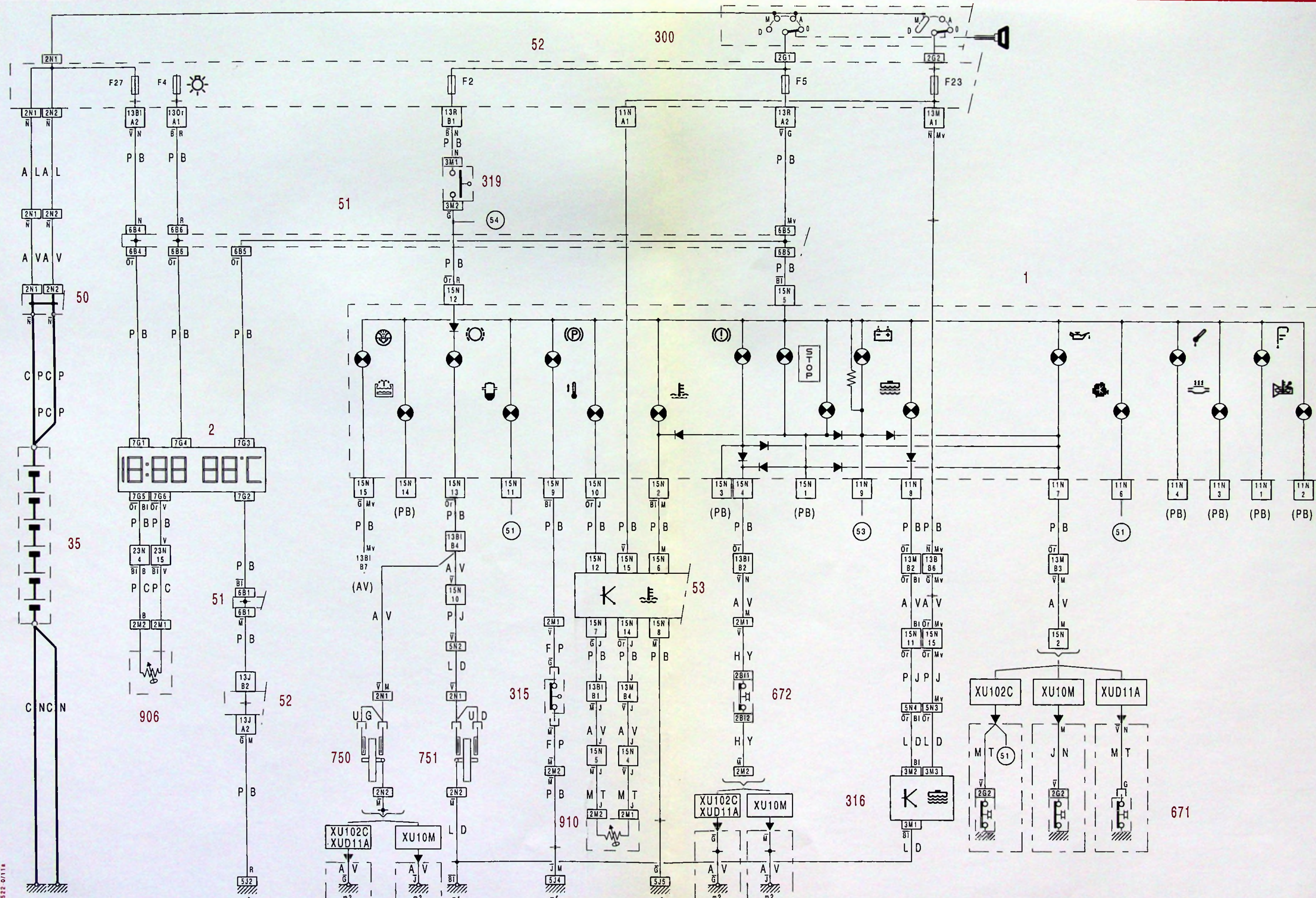

522-0/11a

1 2 3 4 5 6 7 8 9 10 11 12 13 14 15 16 17 18 19 20 21 22 23 24 25 26 27 28 29 30 31 32 33 34 35 36 37 38 39 40 41 42 43 44 45 46 47 48 49 50 51 52 53 54 55 56 57 58 59 60 61 62



52

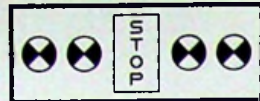

XM
522-0/30

4

5

XM
522-0/30



52

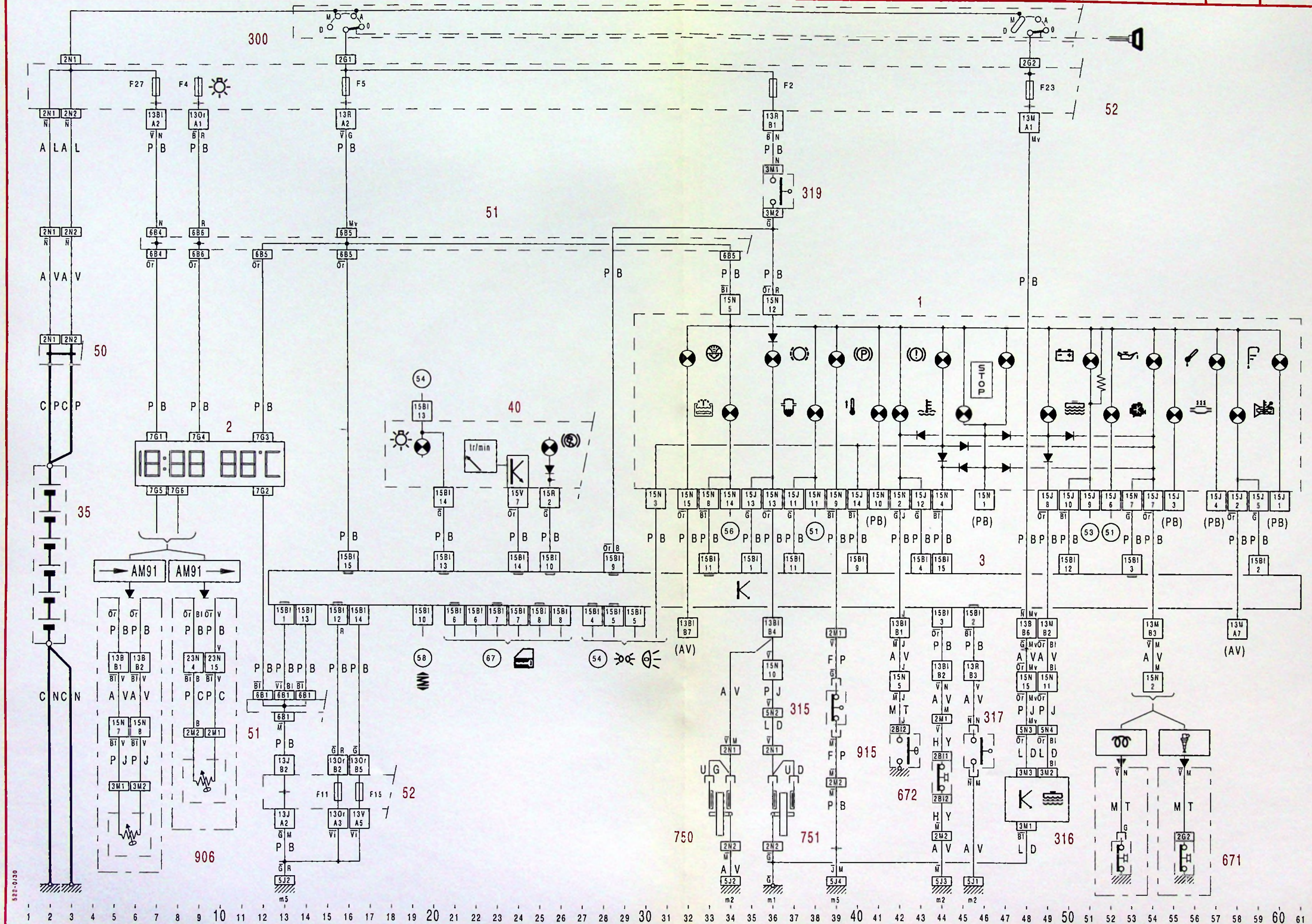

522-0/30

1 2 3 4 5 6 7 8 9 10 11 12 13 14 15 16 17 18 19 20 21 22 23 24 25 26 27 28 29 30 31 32 33 34 35 36 37 38 39 40 41 42 43 44 45 46 47 48 49 50 51 52 53 54 55 56 57 58 59 60 61 62

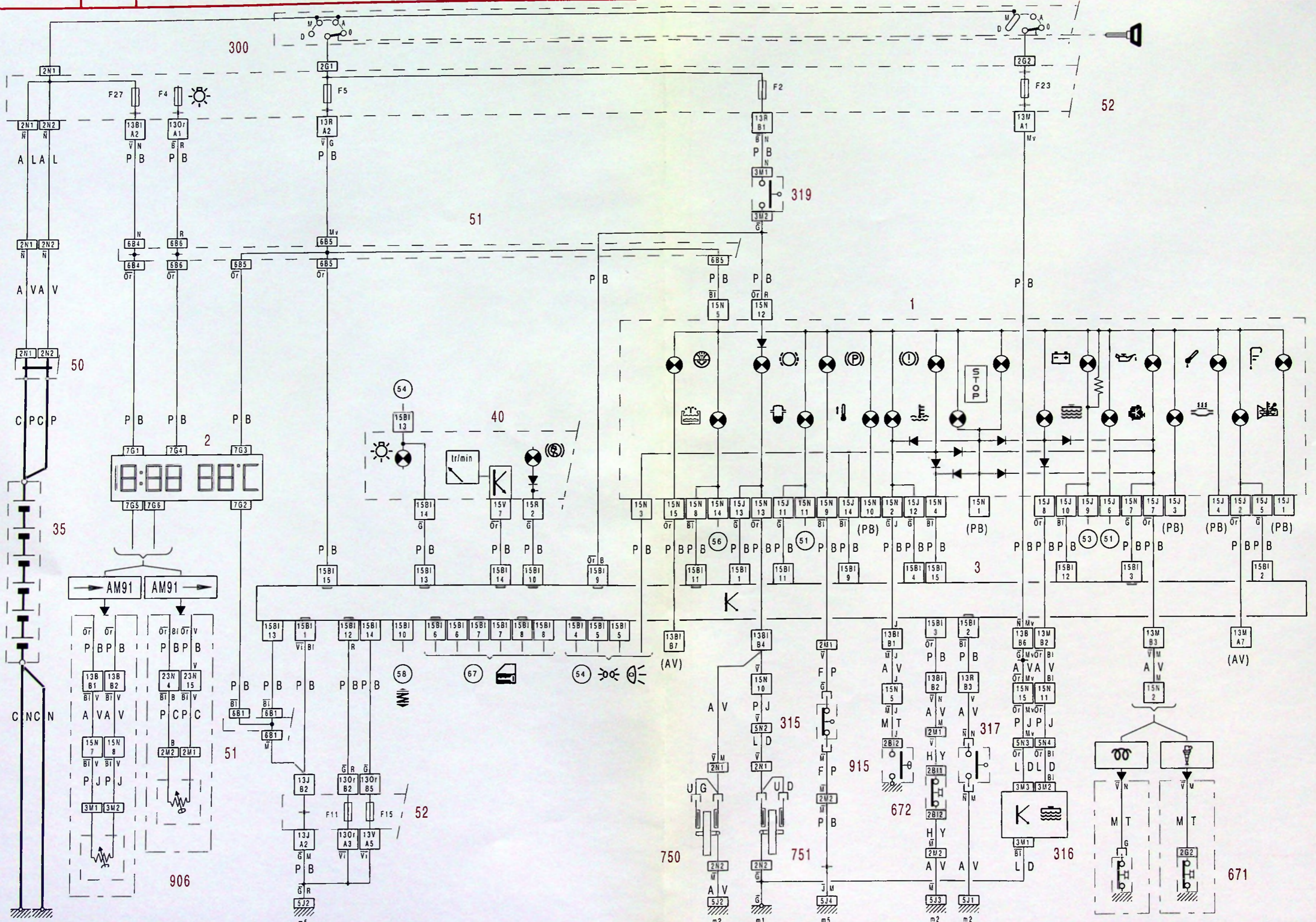
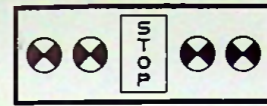
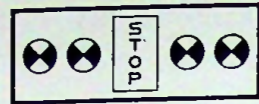

522-0/30a



52



XM
522-0/31

4

5

XM
522-0/31



52

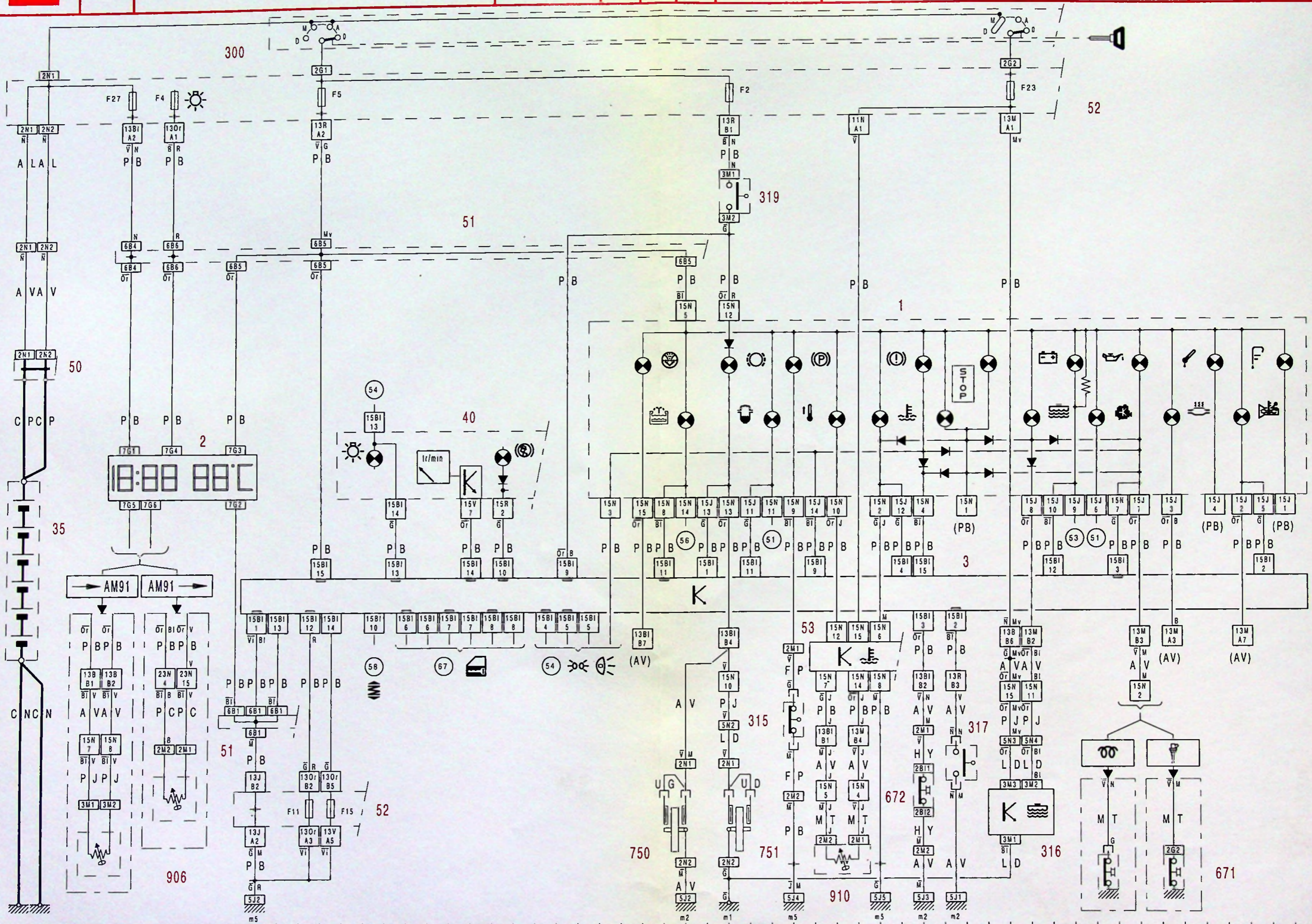

522-0/31

522-0/31



52

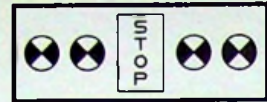

XM
522-1/10a

4

5

XM
522-1/10a



52

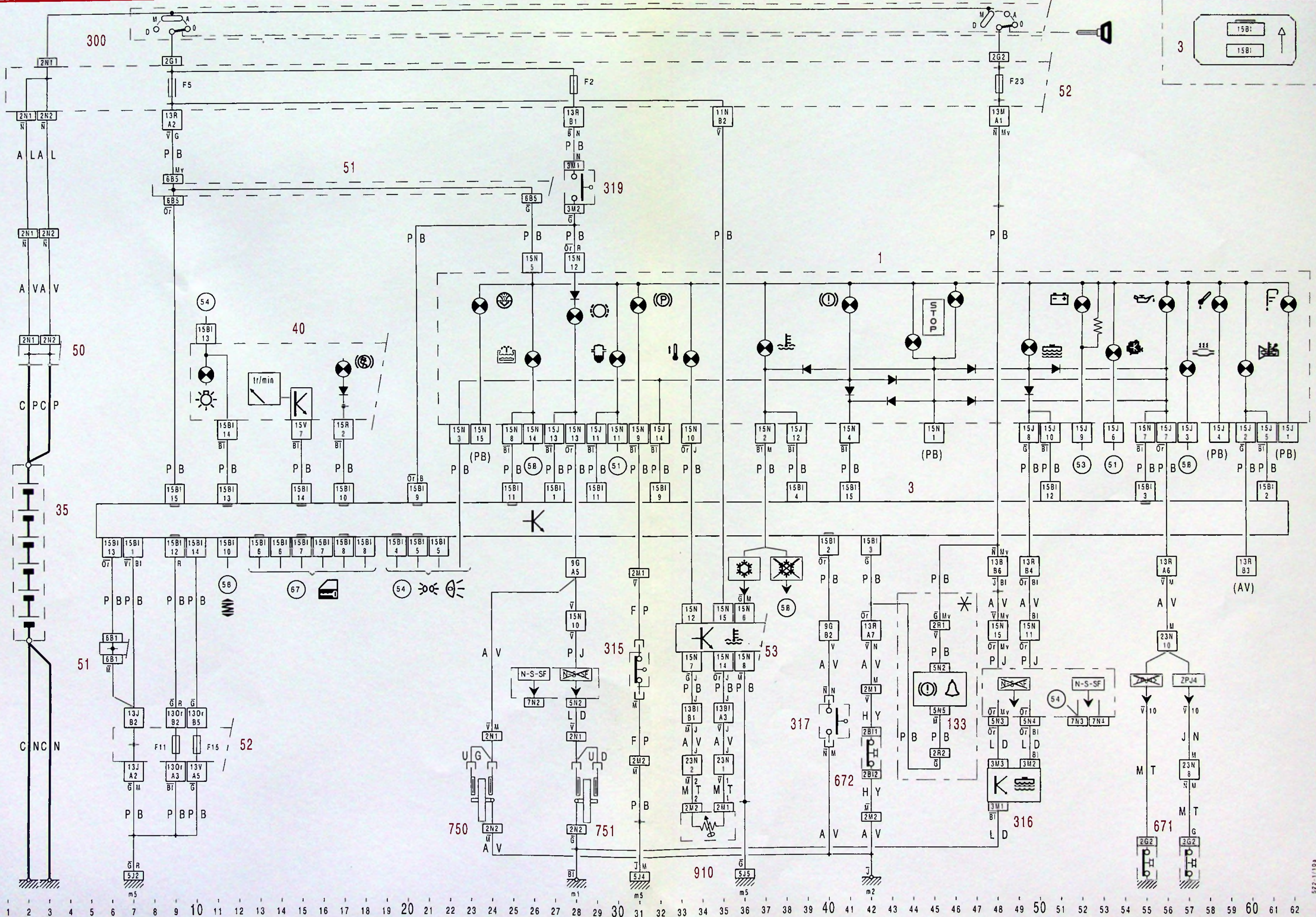



52

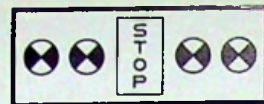

XM
522-1/10a

4

5

XM
522-1/10a



52

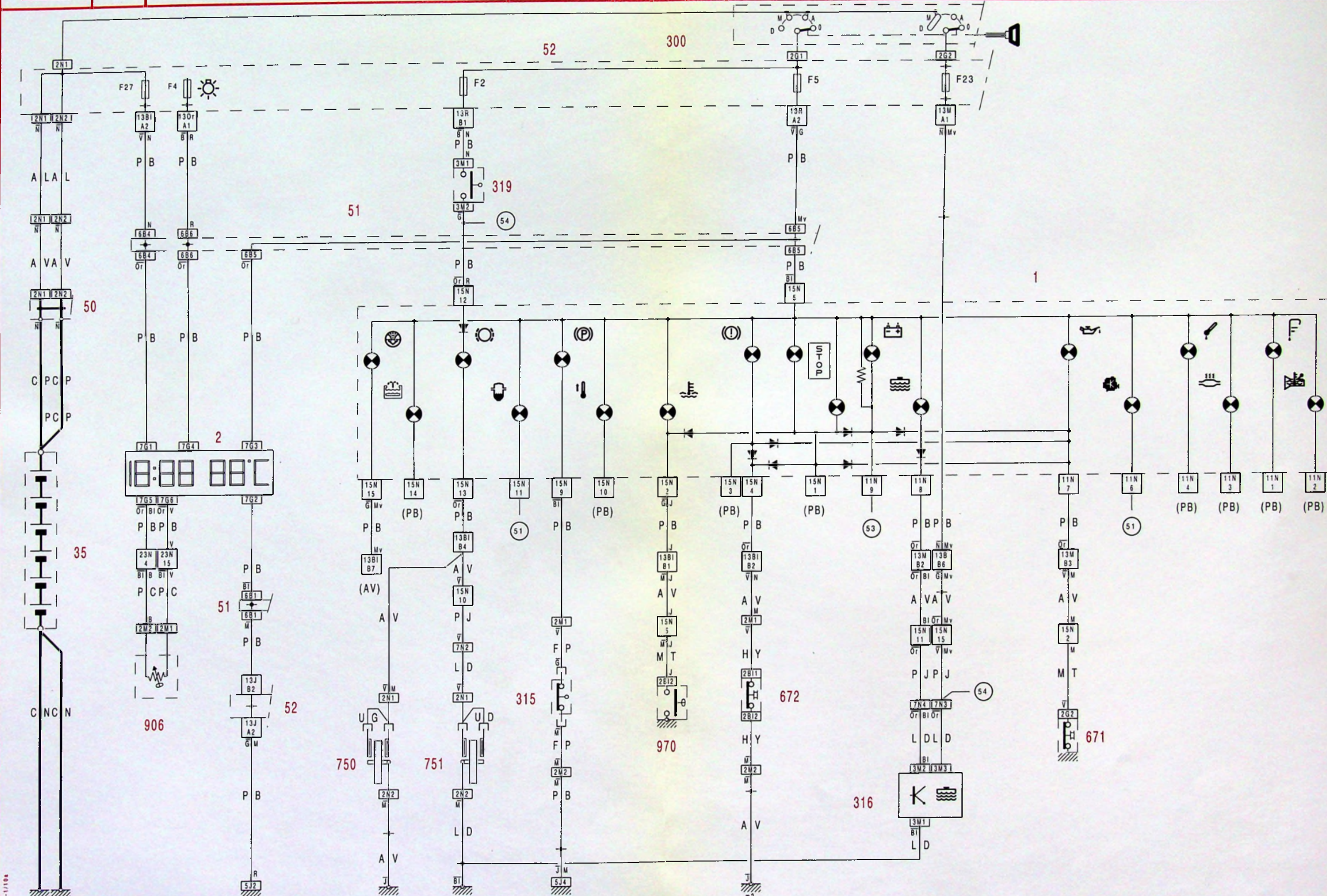

1 2 3 4 5 6 7 8 9 10 11 12 13 14 15 16 17 18 19 20 21 22 23 24 25 26 27 28 29 30 31 32 33 34 35 36 37 38 39 40 41 42 43 44 45 46 47 48 49 50 51 52 53 54 55 56 57 58 59 60 61 62

522-1/10a



52



XM
522-1/11a

4

5

XM
522-1/11a

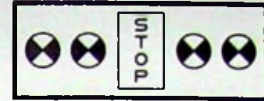

52

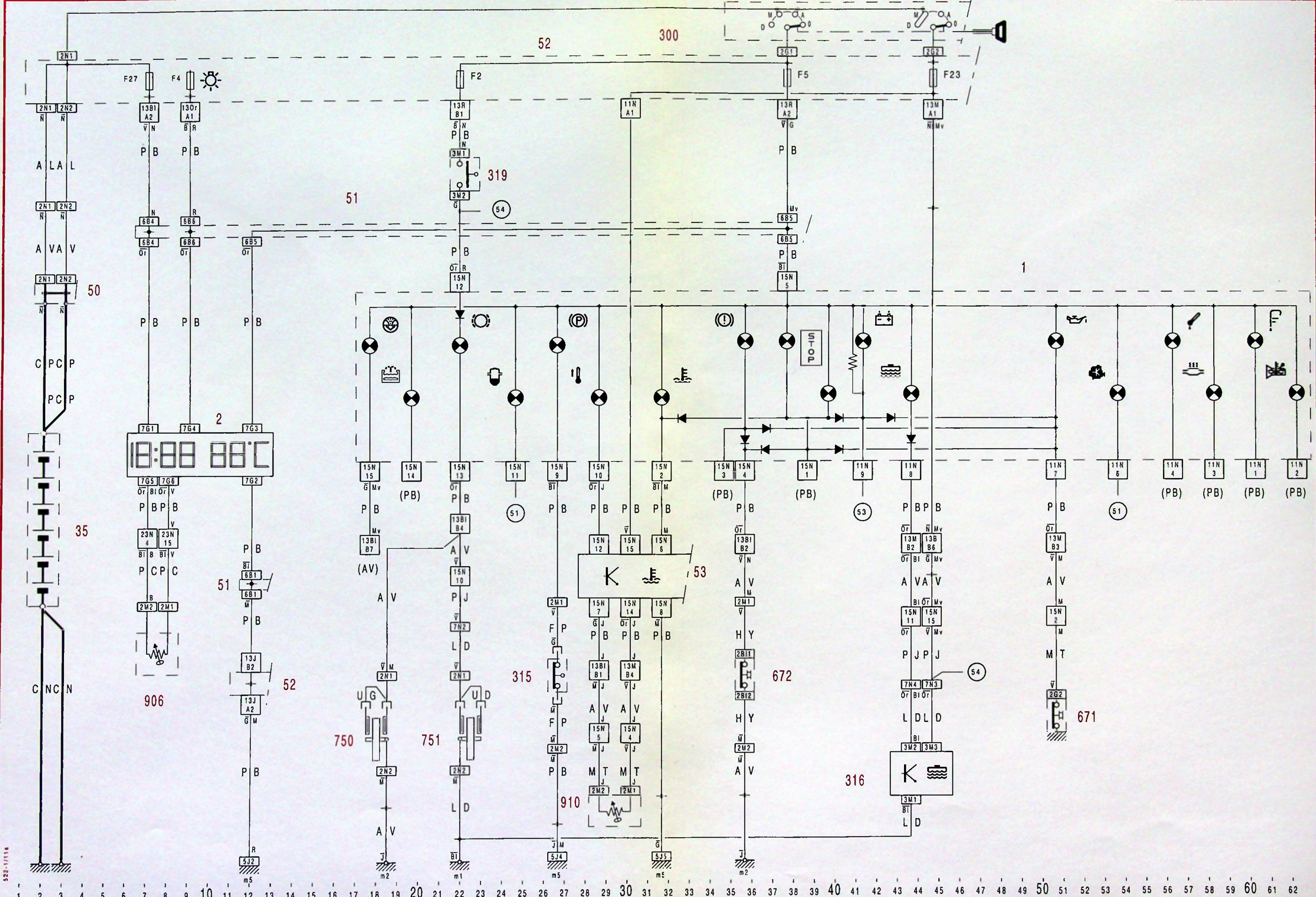

522-1/11a



52

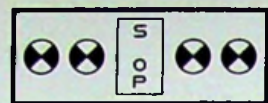

XM 522-1/21a

4

5

XM 522-1/21a



52

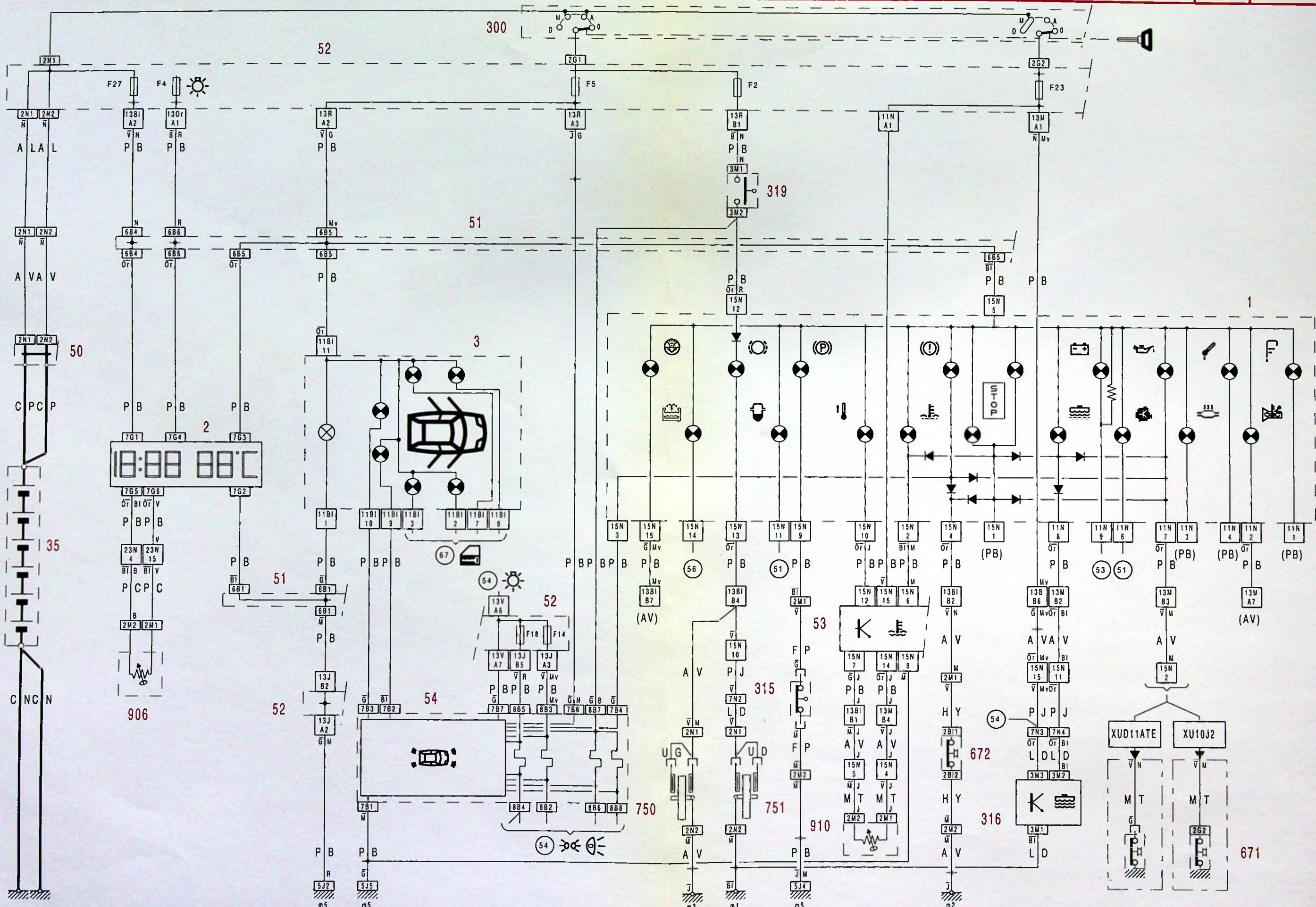

522-1/21a

1 2 3 4 5 6 7 8 9 10 11 12 13 14 15 16 17 18 19 20 21 22 23 24 25 26 27 28 29 30 31 32 33 34 35 36 37 38 39 40 41 42 43 44 45 46 47 48 49 50 51 52 53 54 55 56 57 58 59 60 61 62



52



XM
522-1/30

4

5

XM
522-1/30



52

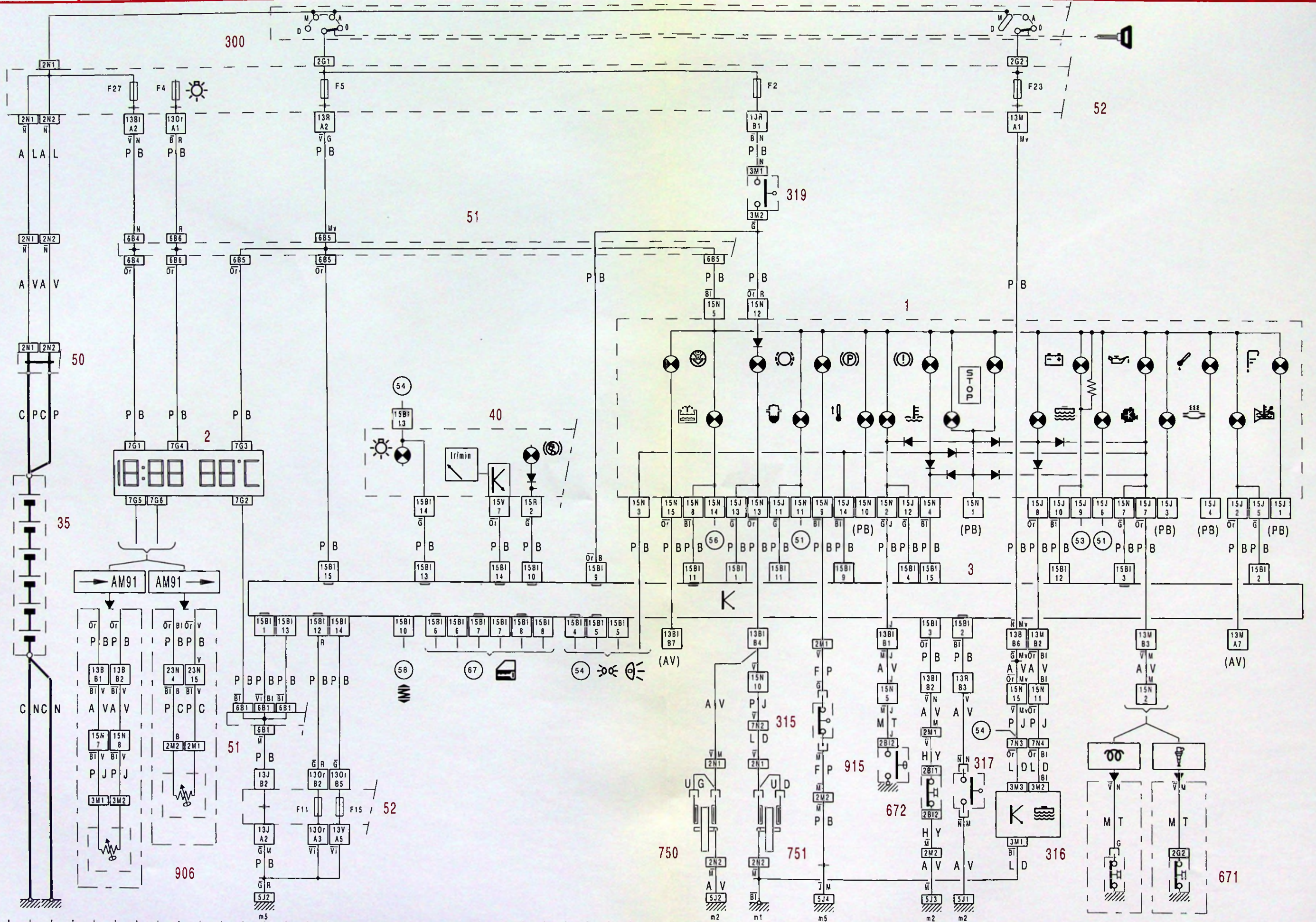

522-1/30

1 2 3 4 5 6 7 8 9 10 11 12 13 14 15 16 17 18 19 20 21 22 23 24 25 26 27 28 29 30 31 32 33 34 35 36 37 38 39 40 41 42 43 44 45 46 47 48 49 50 51 52 53 54 55 56 57 58 59 60 61 62



52



XM
522-1/30a

4

5

XM
522-1/30a



52

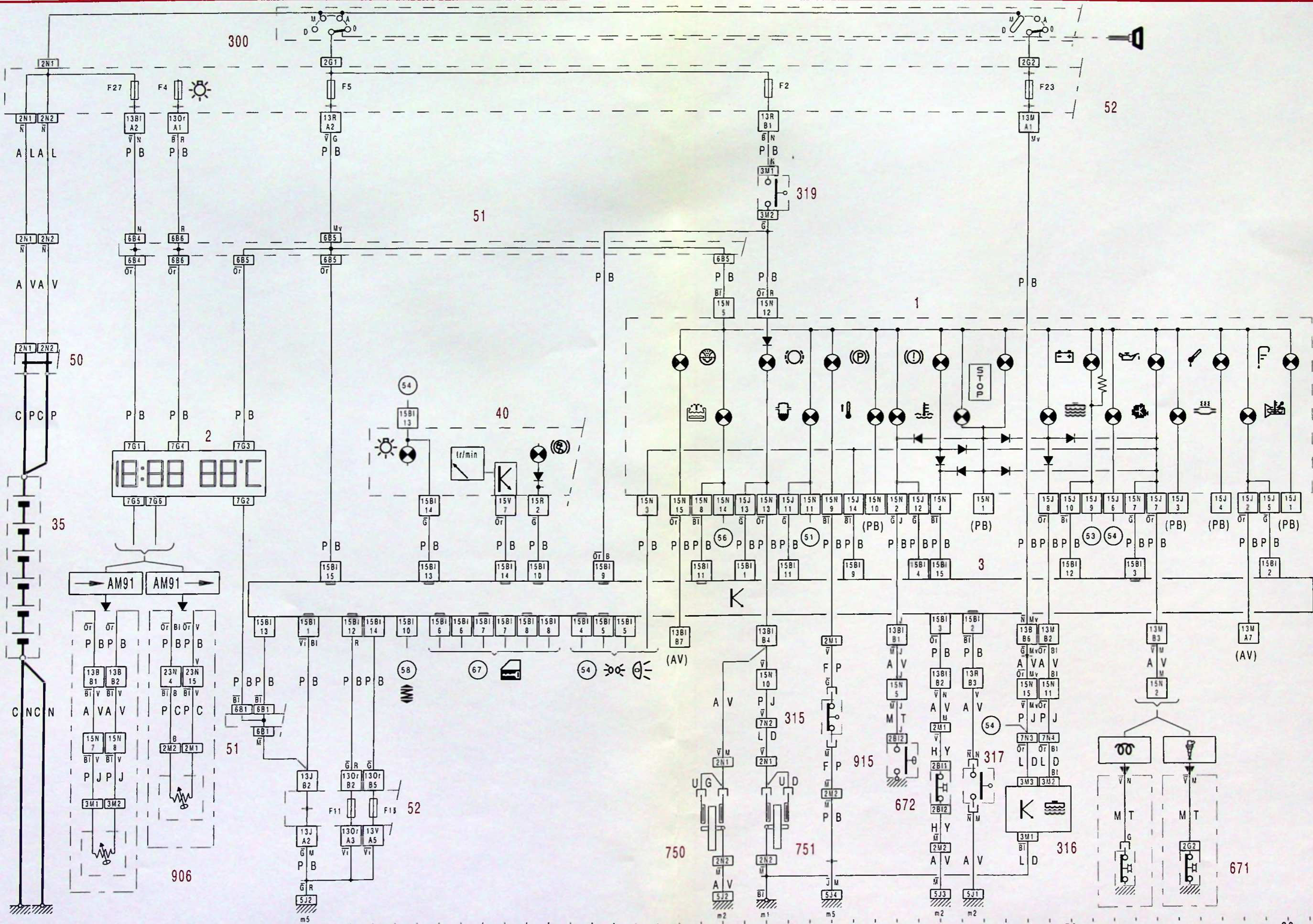

522-1/30a

1 2 3 4 5 6 7 8 9 10 11 12 13 14 15 16 17 18 19 20 21 22 23 24 25 26 27 28 29 30 31 32 33 34 35 36 37 38 39 40 41 42 43 44 45 46 47 48 49 50 51 52 53 54 55 56 57 58 59 60 61 62



52

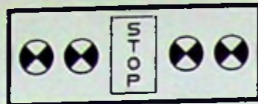

XM
522-1/31a

4

5

XM
522-1/31a

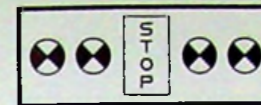

52

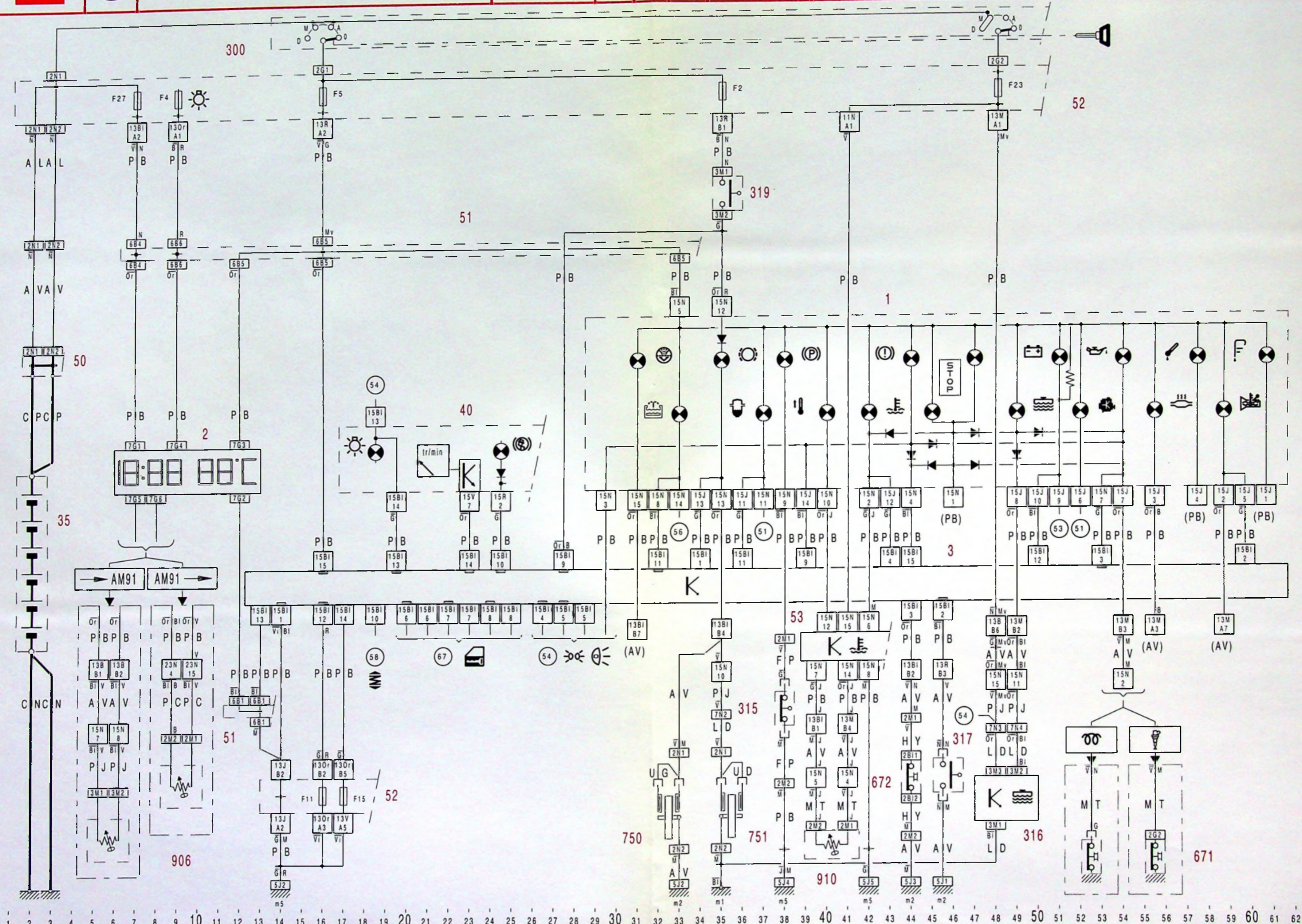

522-1/31a

1 2 3 4 5 6 7 8 9 10 11 12 13 14 15 16 17 18 19 20 21 22 23 24 25 26 27 28 29 30 31 32 33 34 35 36 37 38 39 40 41 42 43 44 45 46 47 48 49 50 51 52 53 54 55 56 57 58 59 60 61 62



52



XM
523-1/20

3

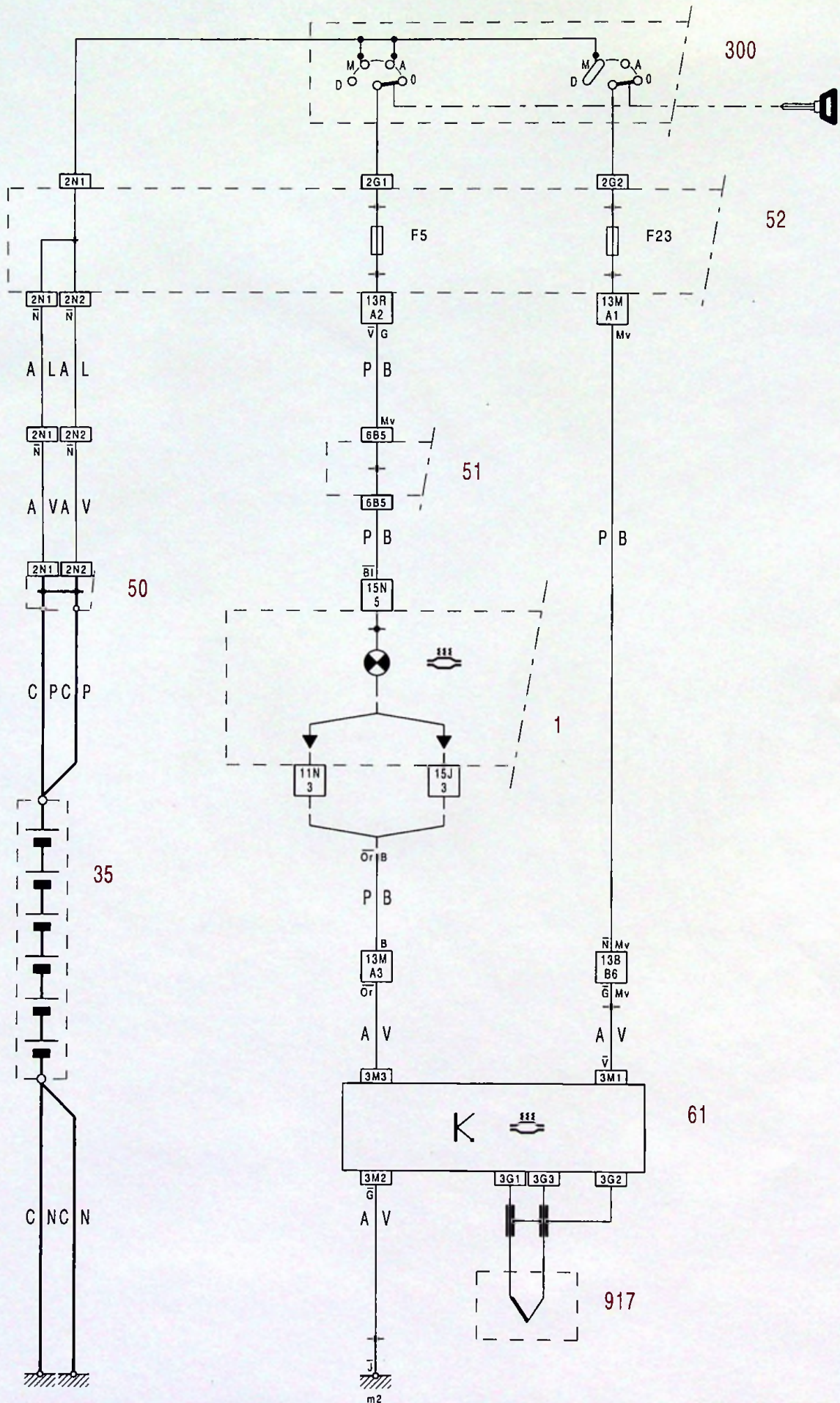

523-1/20

1 2 3 4 5 6 7 8 9 10 11 12 13 14 15 16 17 18 19 20 21 22 23 24 25 26 27 28 29

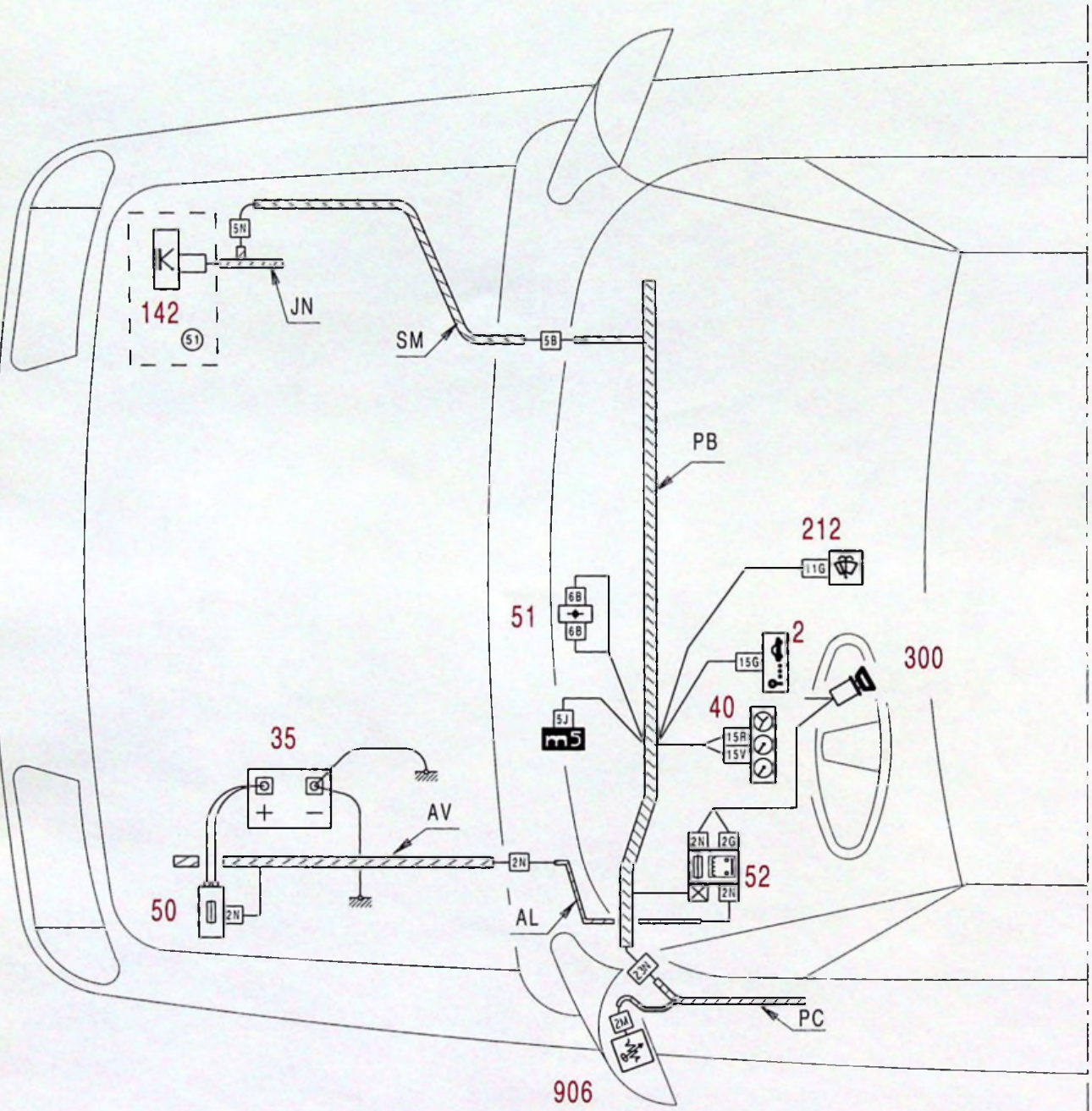



52

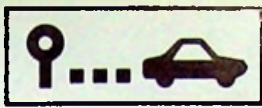

XM
524-0/30

3

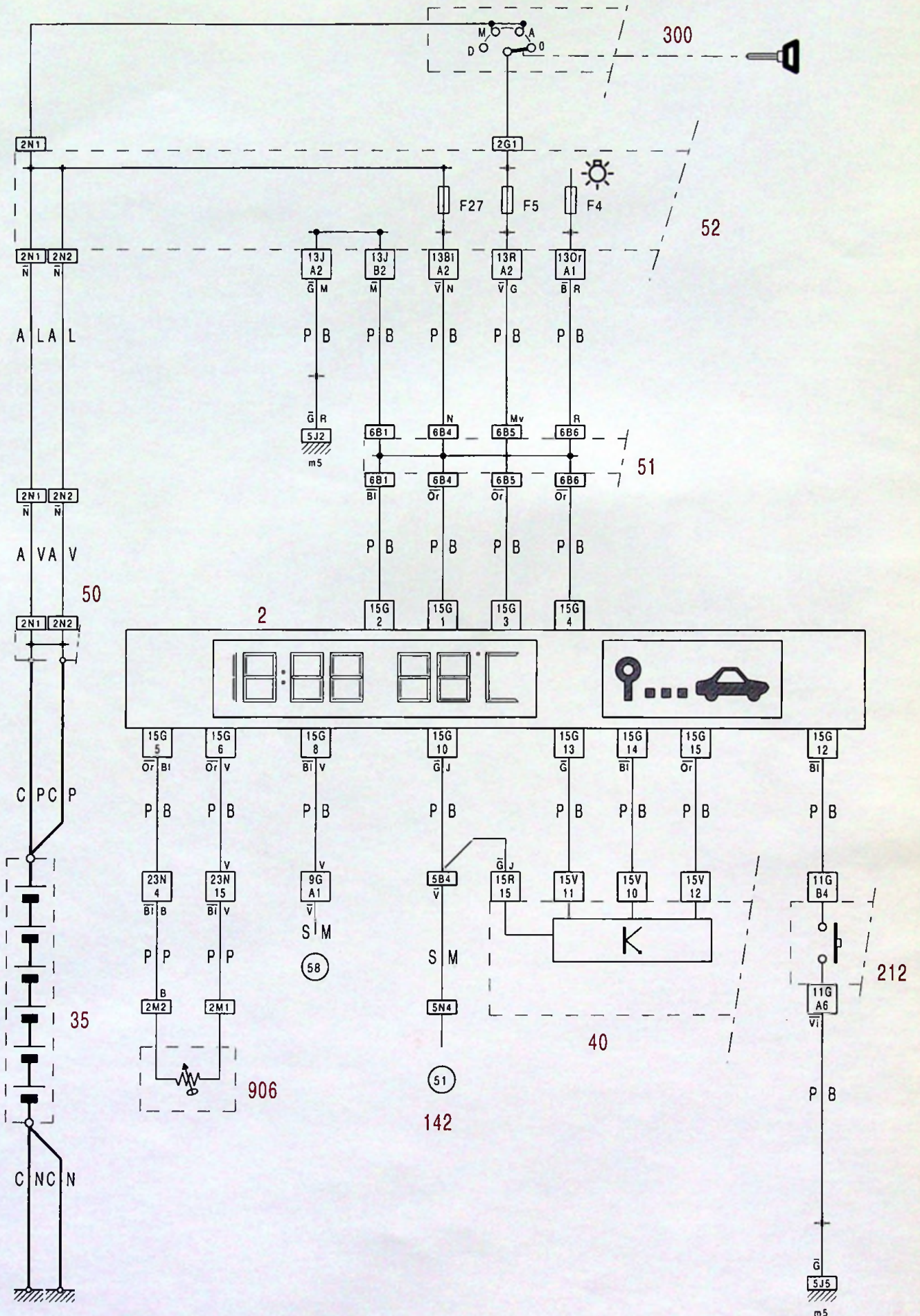

524-0/30

1 2 3 4 5 6 7 8 9 10 11 12 13 14 15 16 17 18 19 20 21 22 23 24 25 26 27 28 29