

CASSETTE TAPE DECK

CT-F900

SERVICE MANUAL



 **PIONEER®**

CONNECTION DIAGRAM OF CT-F900

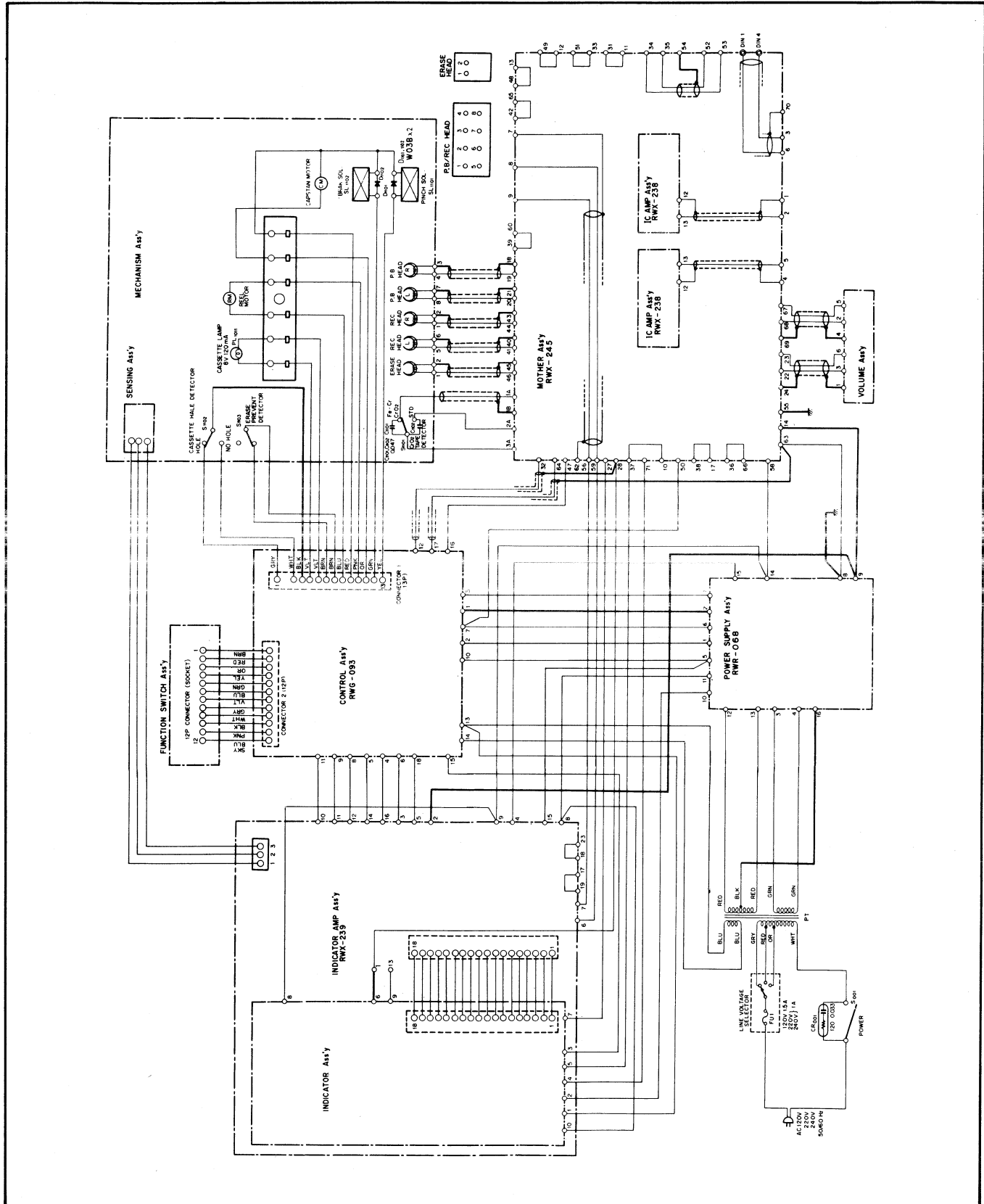

NOTE: The indicated semiconductors are representative ones only. Other alternative semiconductors may be used and are listed in the parts list.

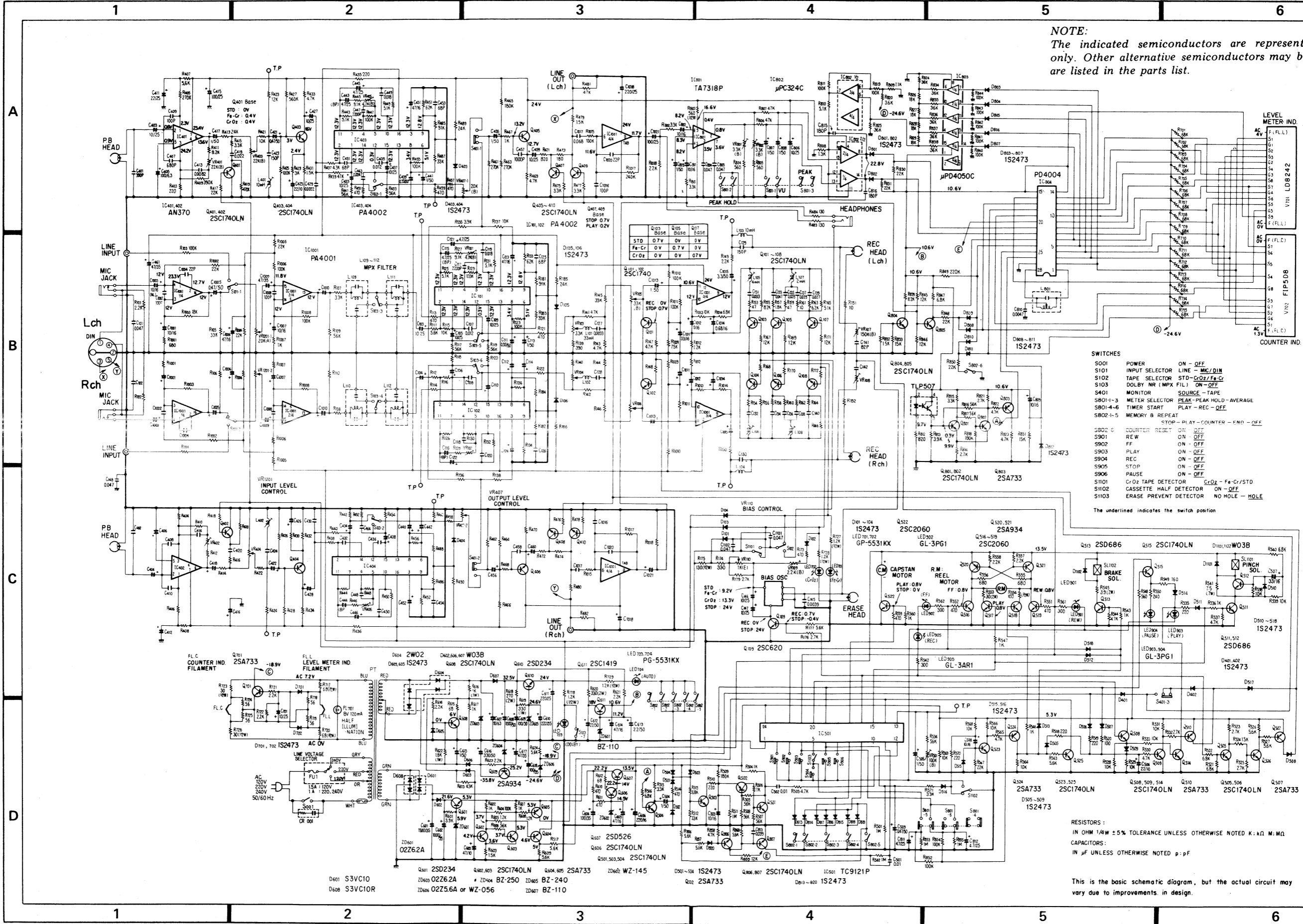

- SWITCHES**
- S001 POWER ON - OFF
 - S101 INPUT SELECTOR LINE - MIC/DIN
 - S102 TAPE SELECTOR STD - CrO₂/Fe-Cr
 - S103 DOLBY NR (MPX FIL) ON - OFF
 - S401 MONITOR SOURCE - TAPE
 - S801-1-3 METER SELECTOR PEAK - PEAK HOLD - AVERAGE
 - S801-4-6 TIMER START PLAY - REC - OFF
 - S802-1-5 MEMORY & REPEAT STOP - PLAY - COUNTER - END - OFF
 - S802-6 COUNTER RESET ON - OFF
 - S901 REW ON - OFF
 - S902 FF ON - OFF
 - S903 PLAY ON - OFF
 - S904 REC ON - OFF
 - S905 STOP ON - OFF
 - S906 PAUSE ON - OFF
 - S1101 CrO₂ TAPE DETECTOR ON - OFF
 - S1102 CASSETTE HALF DETECTOR ON - OFF
 - S1103 ERASE PREVENT DETECTOR NO HOLE - HOLE
- The underlined indicates the switch position

RESISTORS:
IN OHM 1/4W ±5% TOLERANCE UNLESS OTHERWISE NOTED K: kΩ M: MΩ

CAPACITORS:
IN μF UNLESS OTHERWISE NOTED p: pF

This is the basic schematic diagram, but the actual circuit may vary due to improvements in design.

MOTHER ASSEMBLY(RWX-245) OF CT-F900

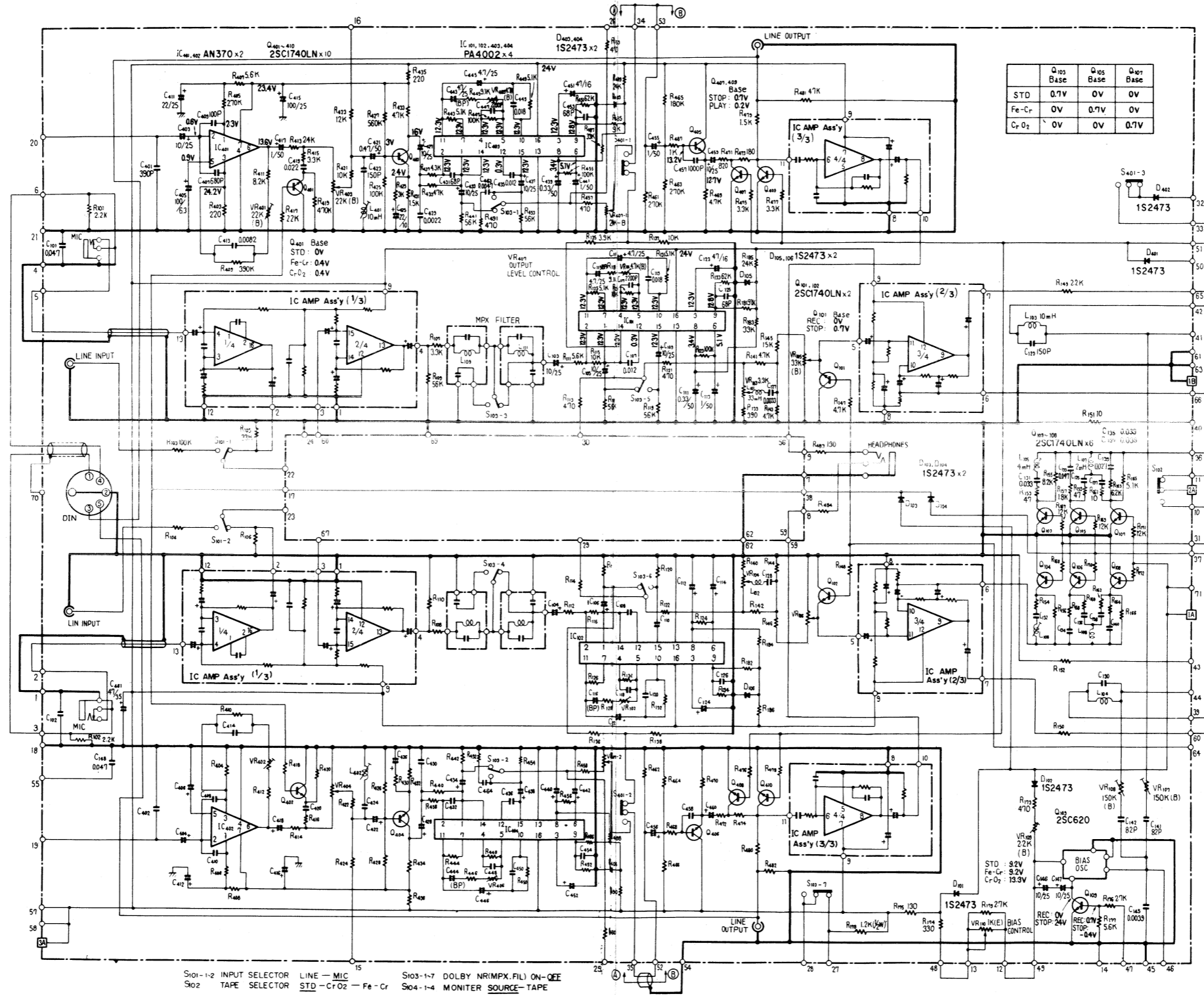

Foil side

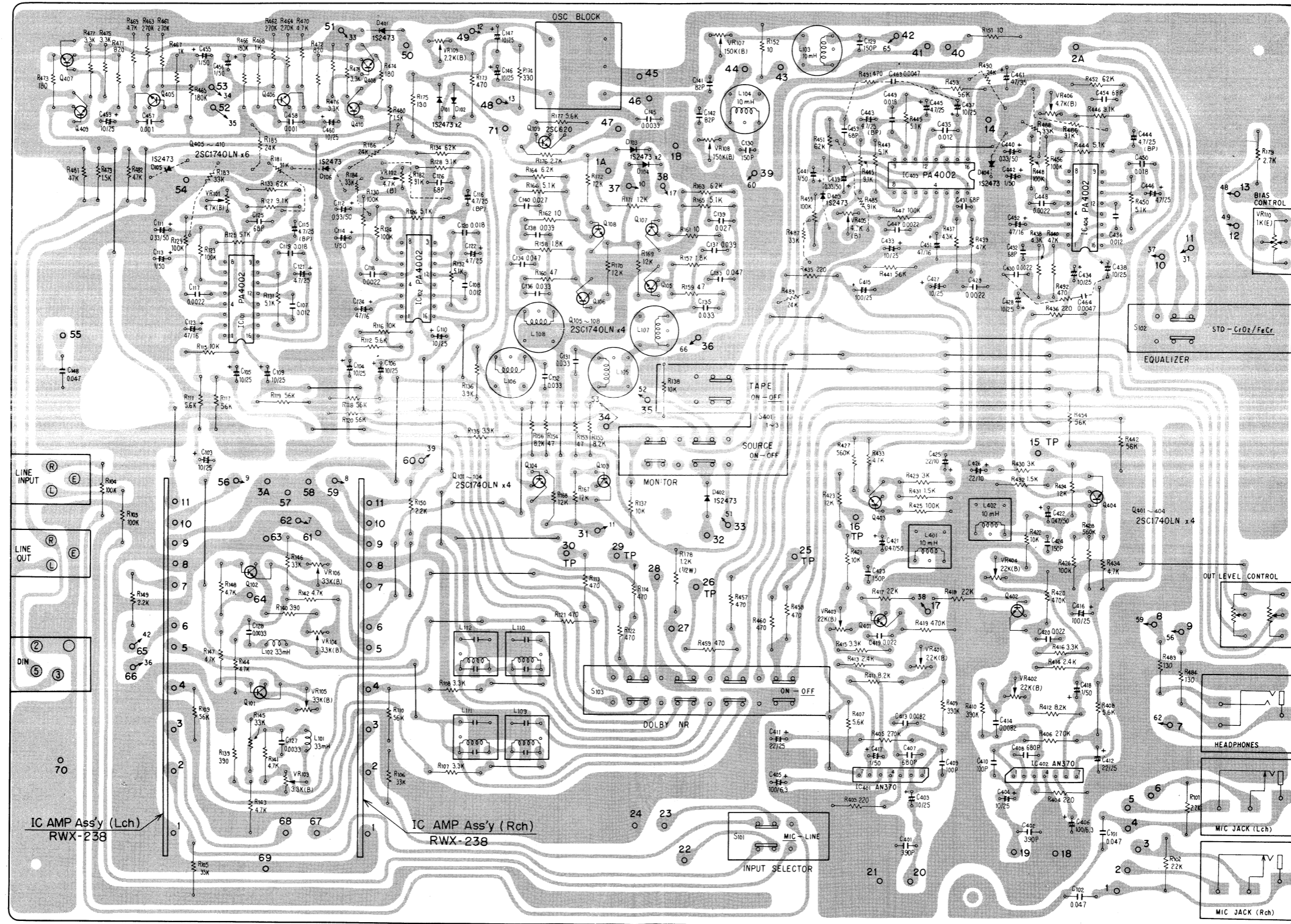

POWER SUPPLY ASSEMBLY(RWR-068) OF CT-F900

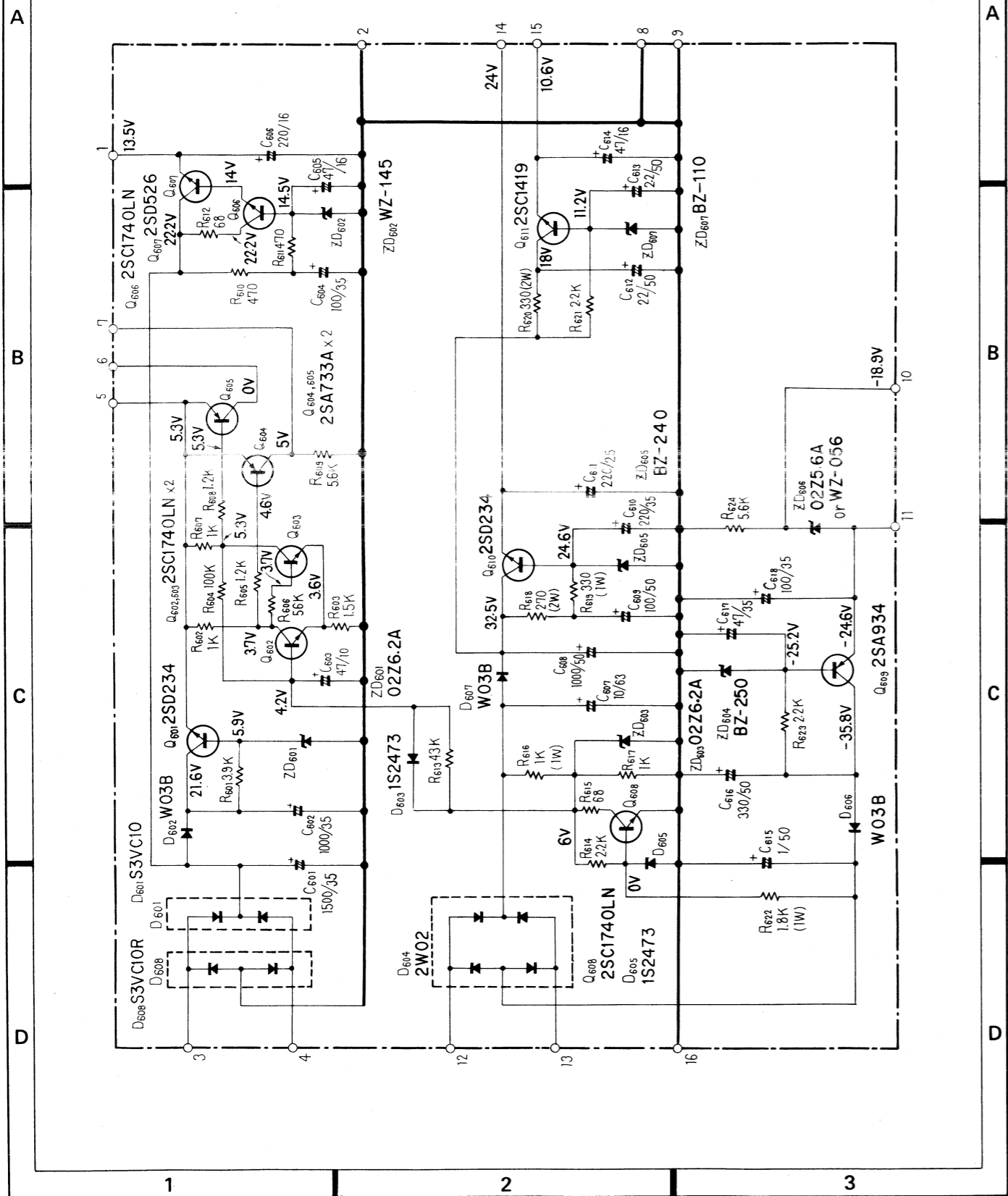

Foil side

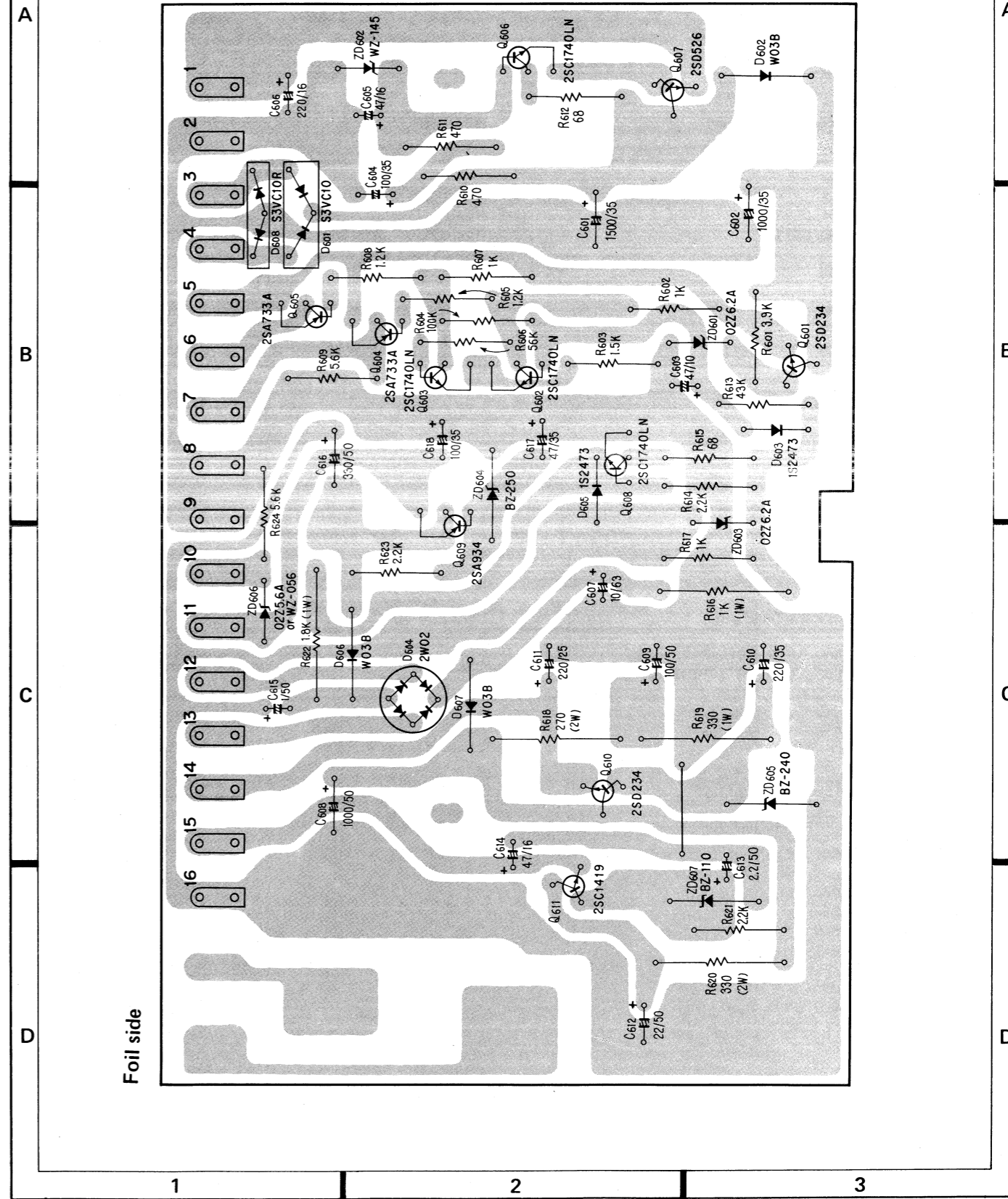

FUNCTION SWITCH ASSEMBLY

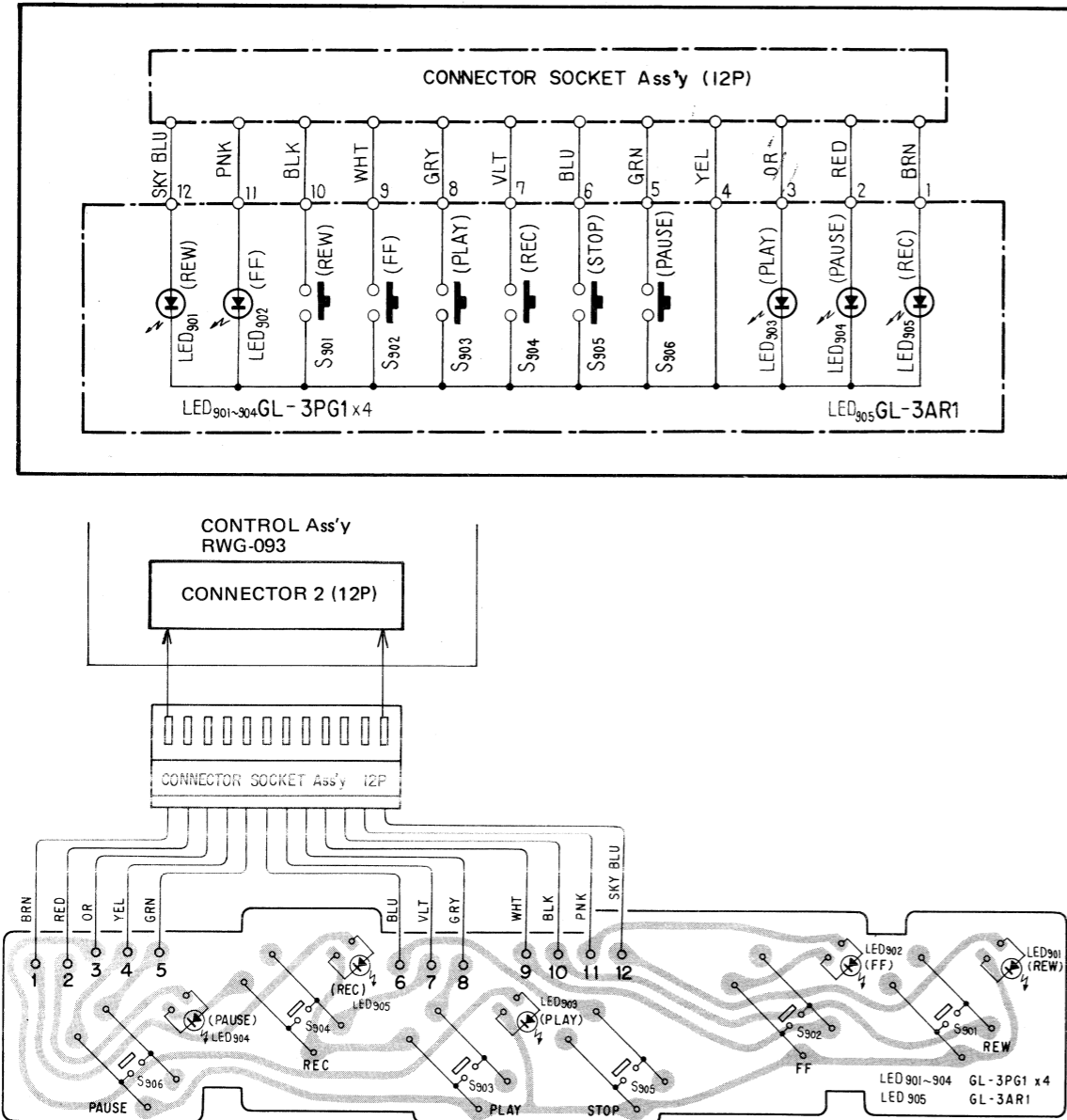

VOLUME ASSEMBLY

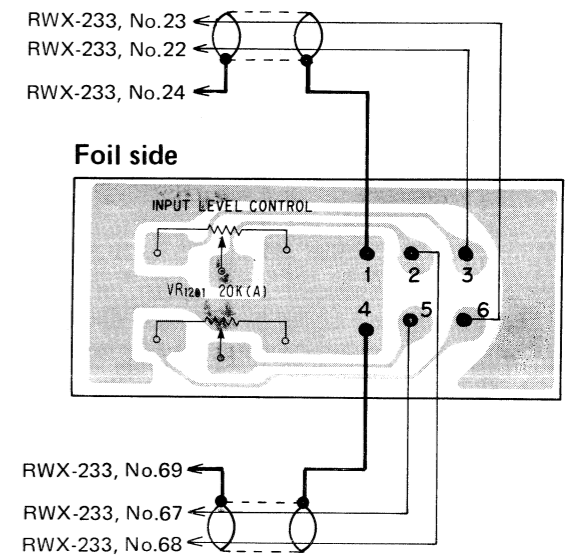
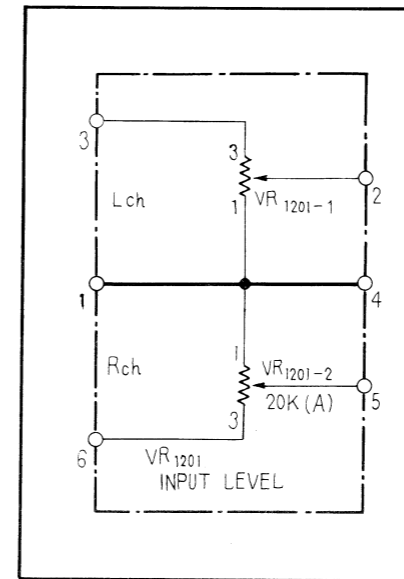

Parts List

Part No.	Symbol & Description
RCV-056	VR1201 Volume 20k-A (INPUT)

SENSING ASSEMBLY

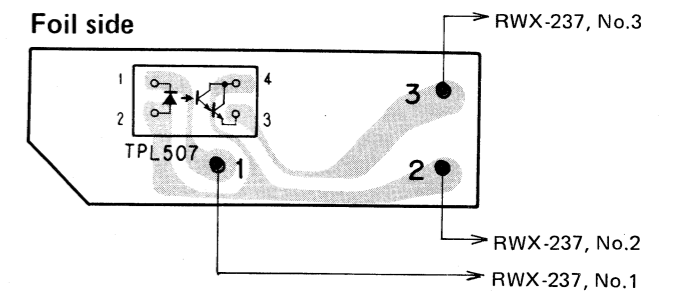
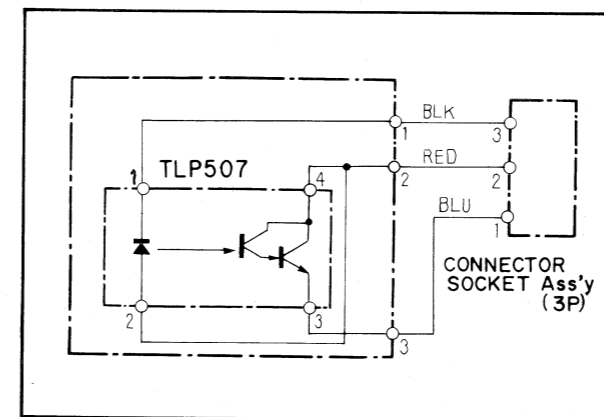

Integrated Amplifier Assembly (RWX-238)

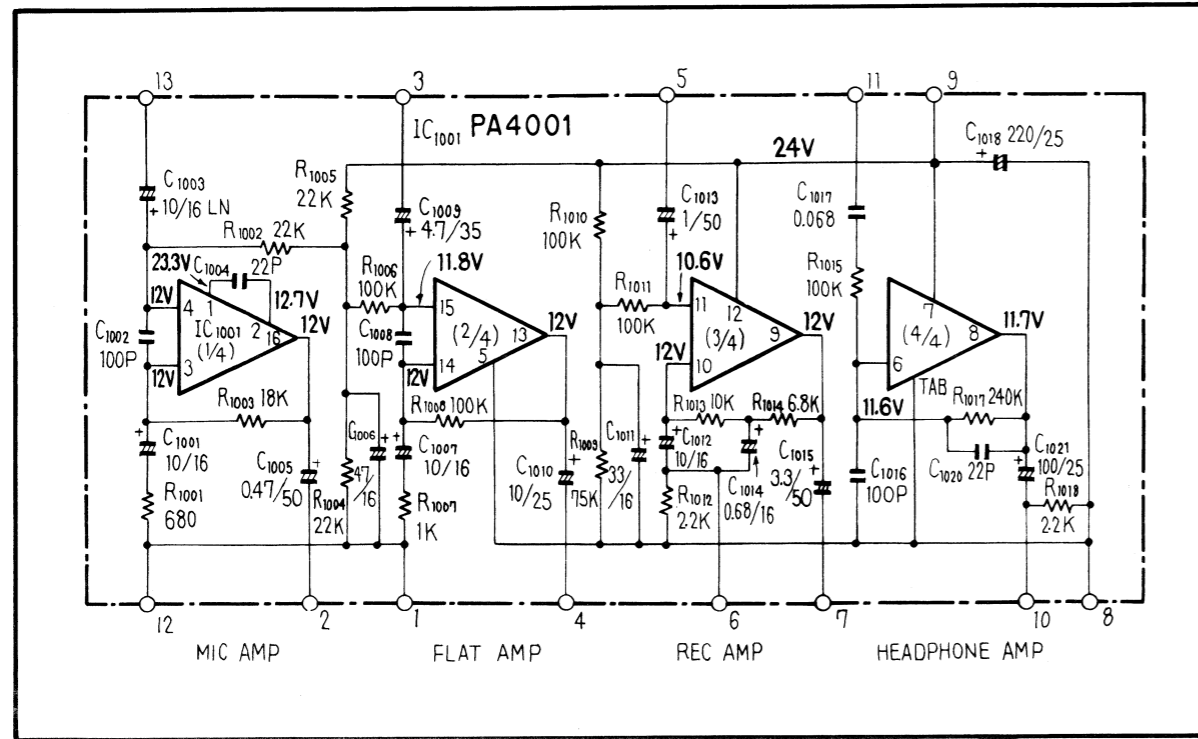

INDICATOR ASSEMBLY

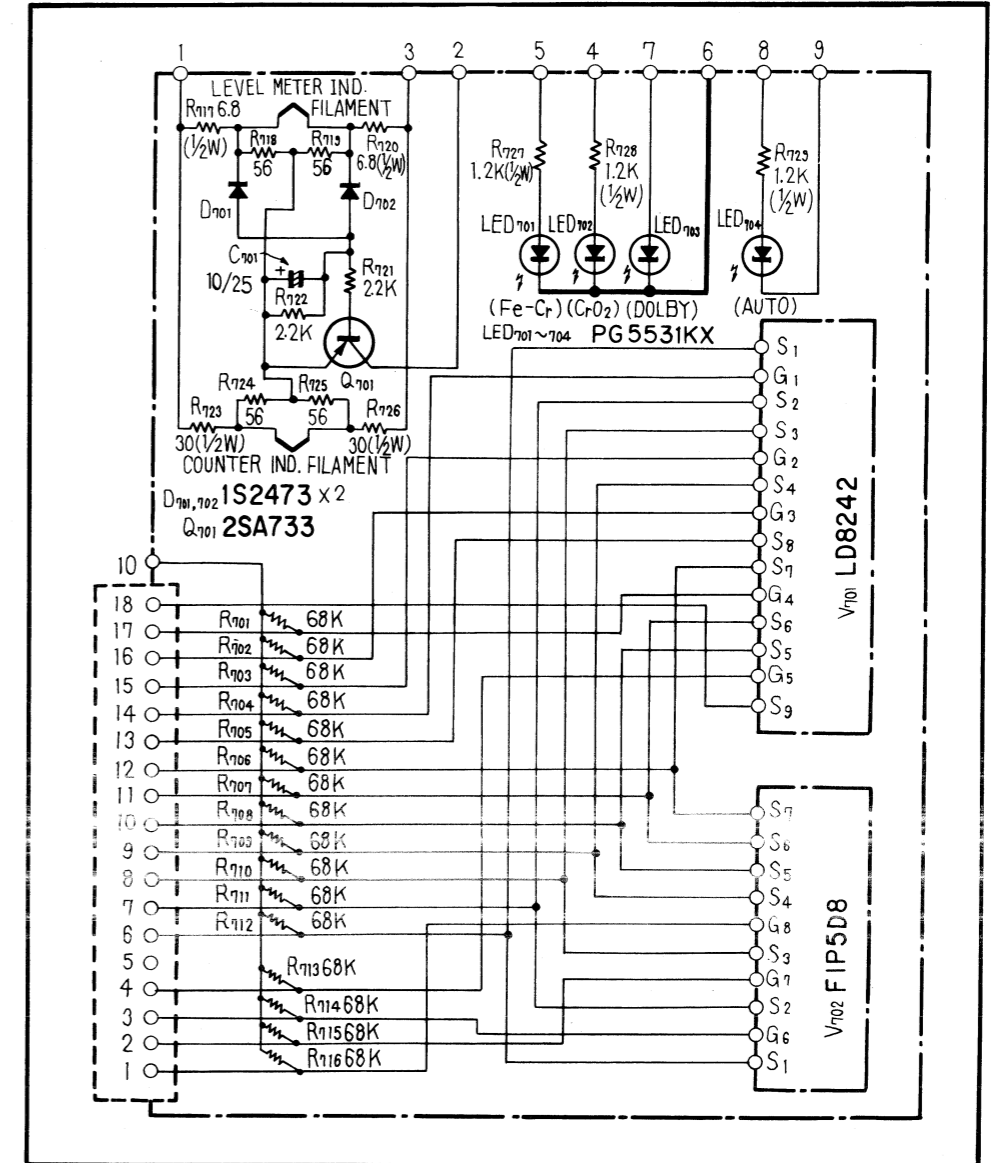

RWX-233, No.5
(RWX-233, No.2)
RWX-233, No.4
(RWX-233, No.1)

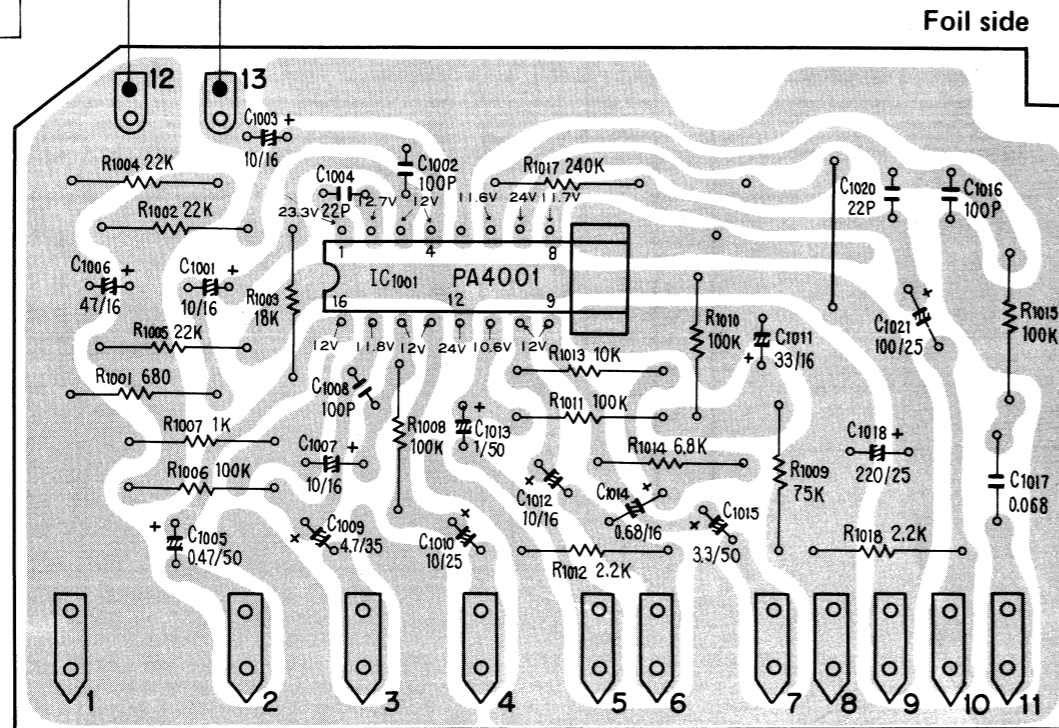

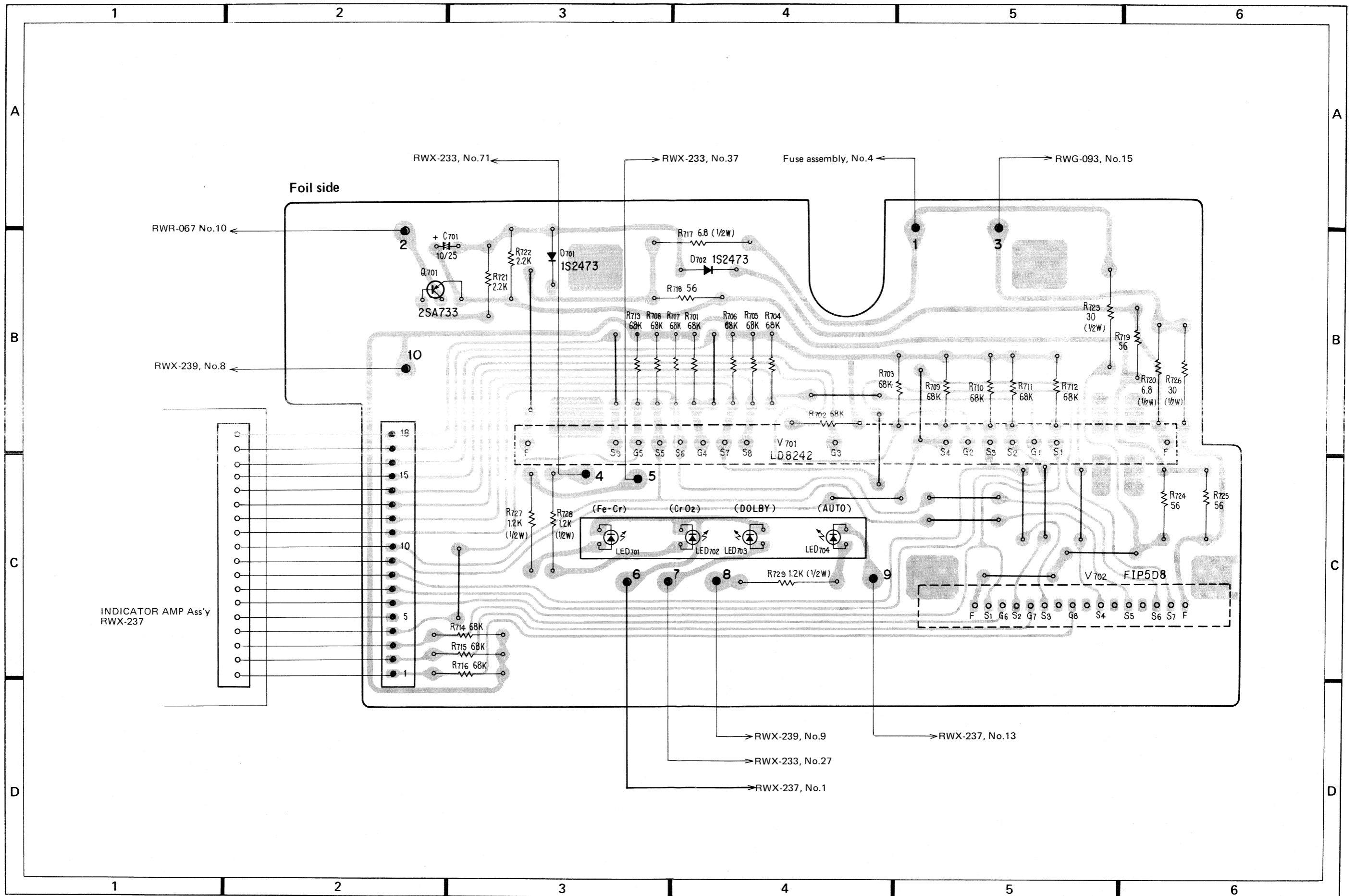

INDICATOR AMPLIFIER ASSEMBLY (RWX-239)

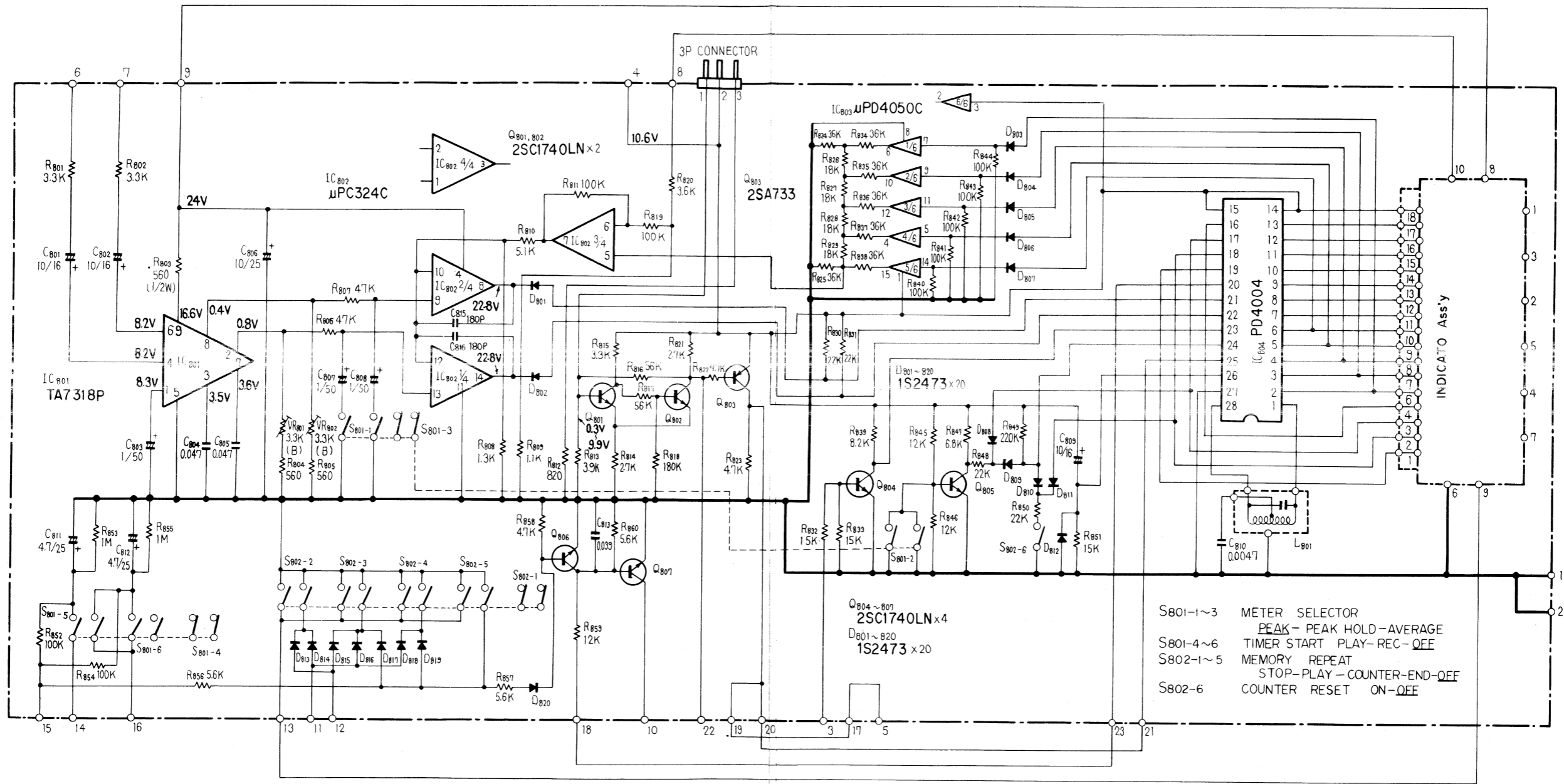

- S801-1~3 METER SELECTOR
PEAK - PEAK HOLD - AVERAGE
- S801-4~6 TIMER START PLAY-REC-QFF
- S802-1~5 MEMORY REPEAT
STOP-PLAY - COUNTER-END-QFF
- S802-6 COUNTER RESET ON-QFF

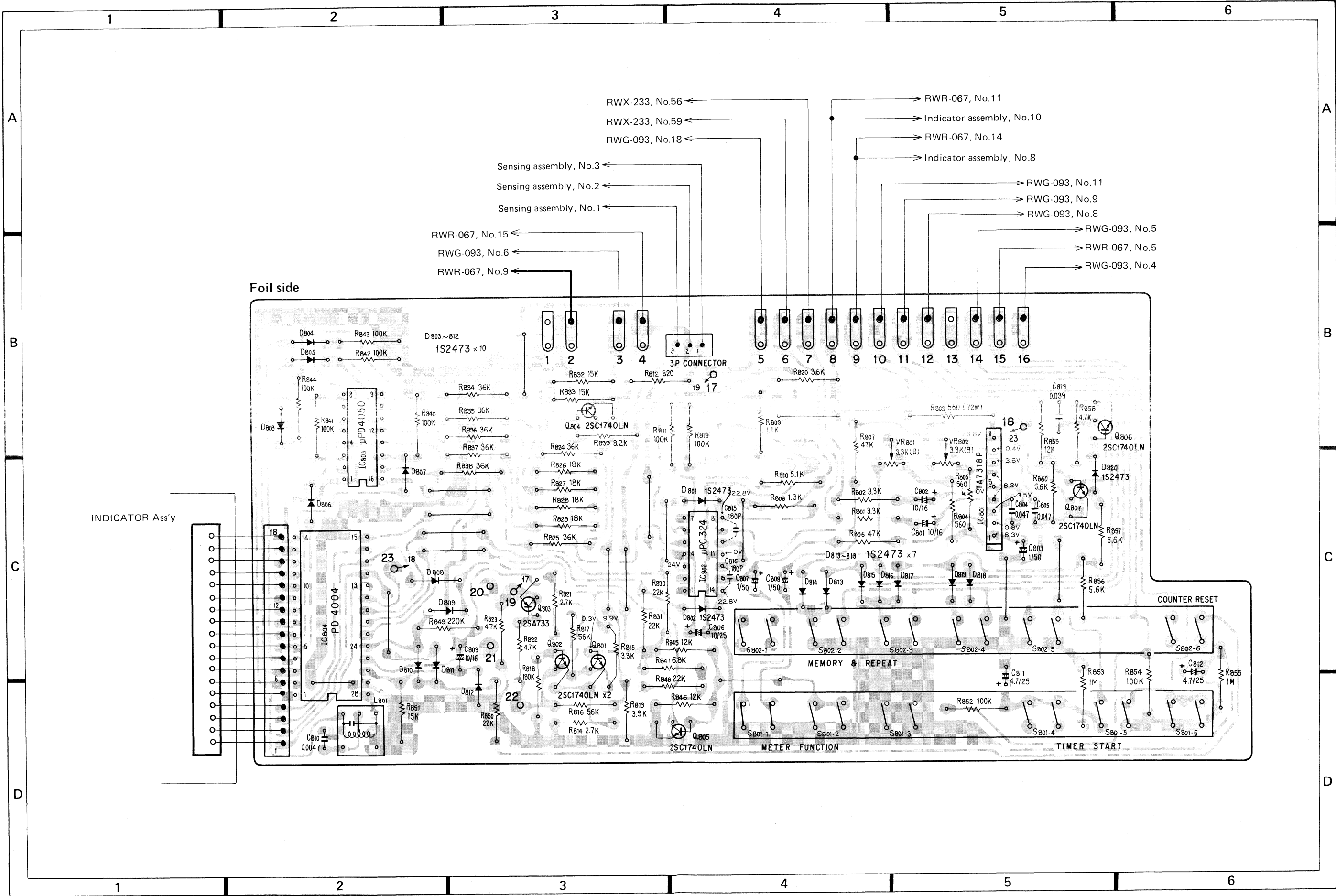

CONTROL ASSEMBLY (RWG-093)

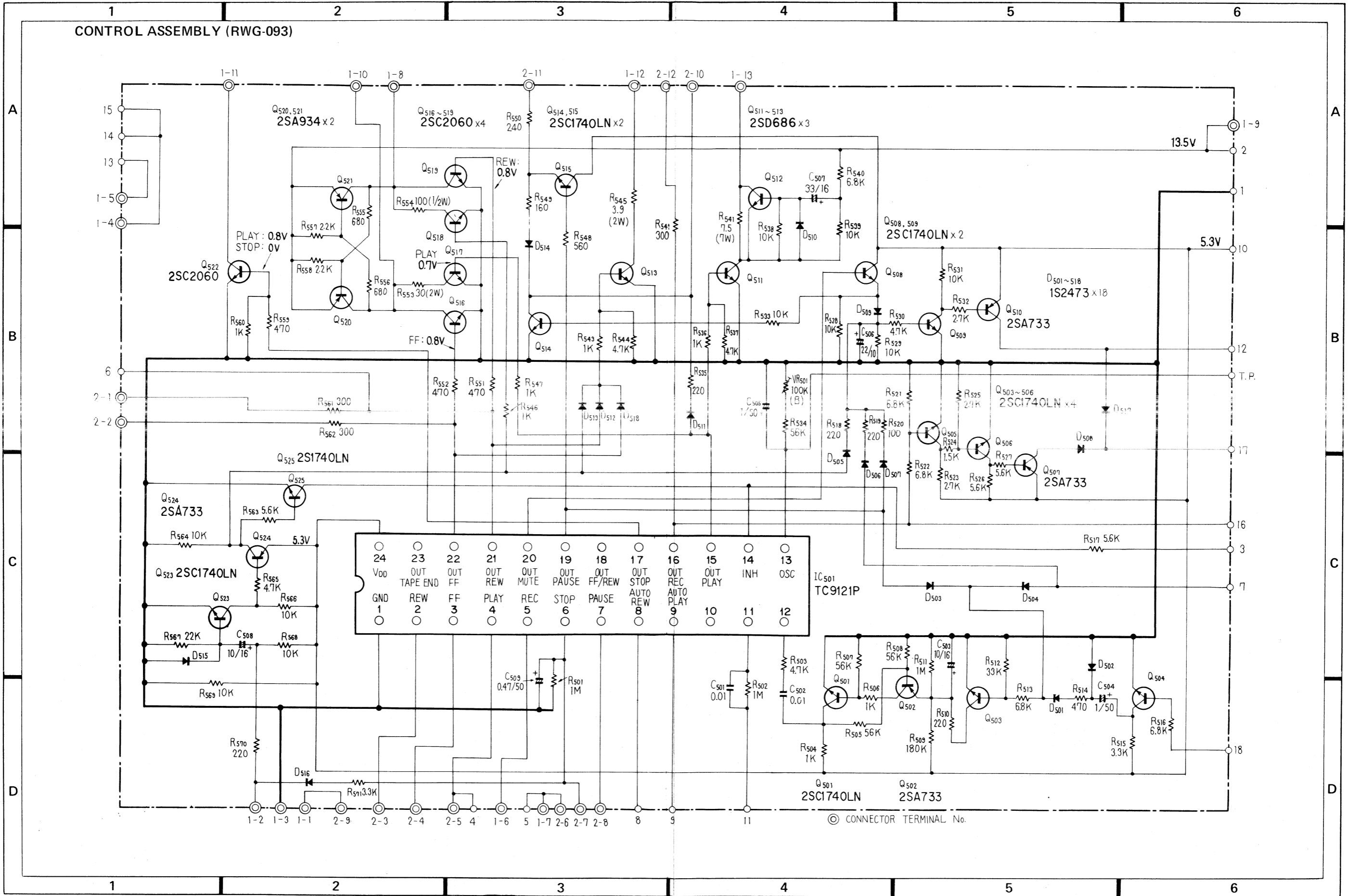

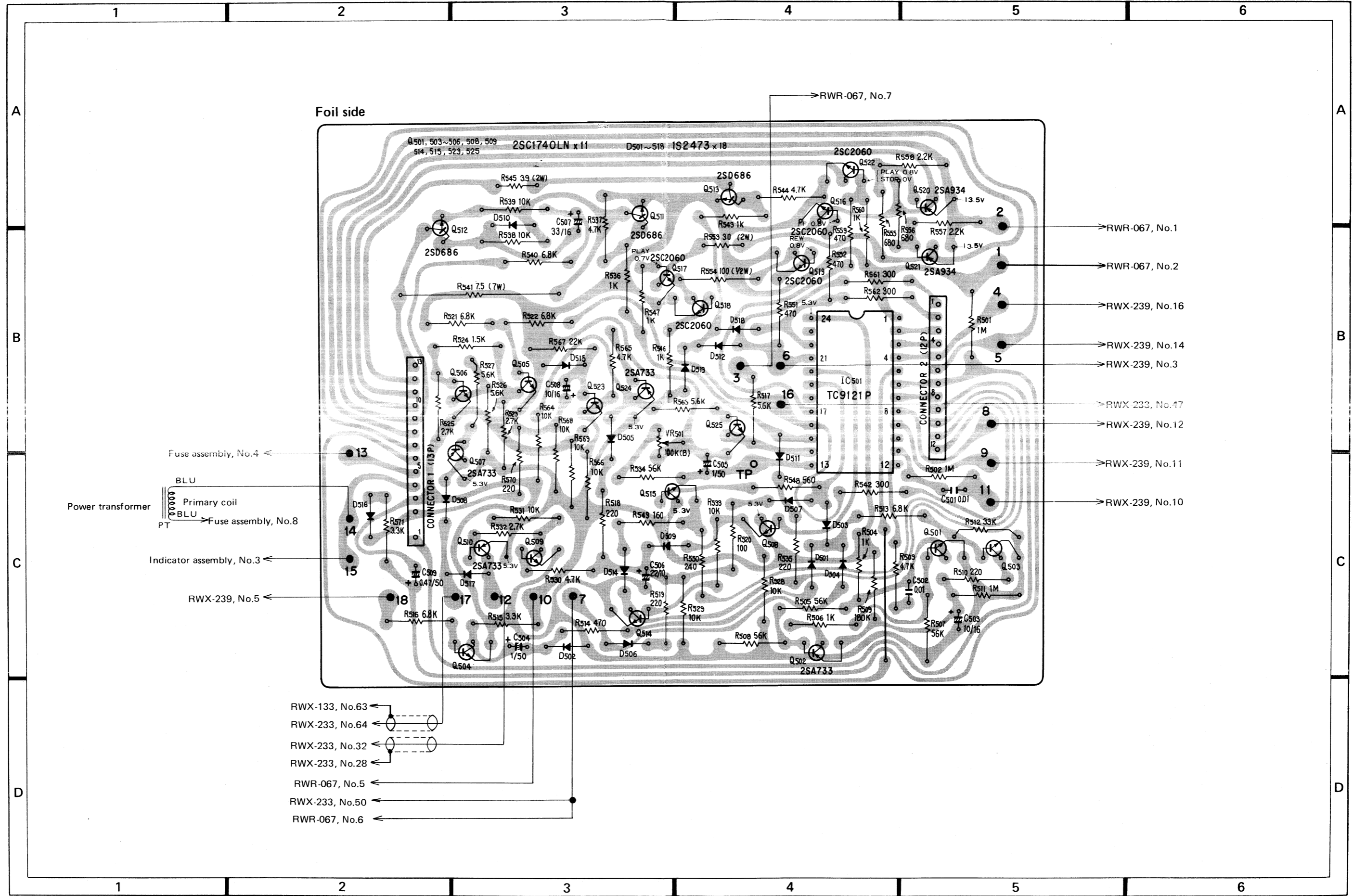

Foil side

Fuse assembly, No.4 ←

Power transformer
 BLU
 Primary coil
 CBLU
 PT → Fuse assembly, No.8

Indicator assembly, No.3 ←

RWX-239, No.5 ←

→ RWR-067, No.1

→ RWR-067, No.2

→ RWX-239, No.16

→ RWX-239, No.14

→ RWX-239, No.3

→ RWX-233, No.47

→ RWX-239, No.12

→ RWX-239, No.11

→ RWX-239, No.10

RWX-133, No.63 ←

RWX-233, No.64 ←

RWX-233, No.32 ←

RWX-233, No.28 ←

RWR-067, No.5 ←

RWX-233, No.50 ←

RWR-067, No.6 ←

EXPLODED VIEWS

EXTERIOR

NOTE:  marked parts cannot be supplied.

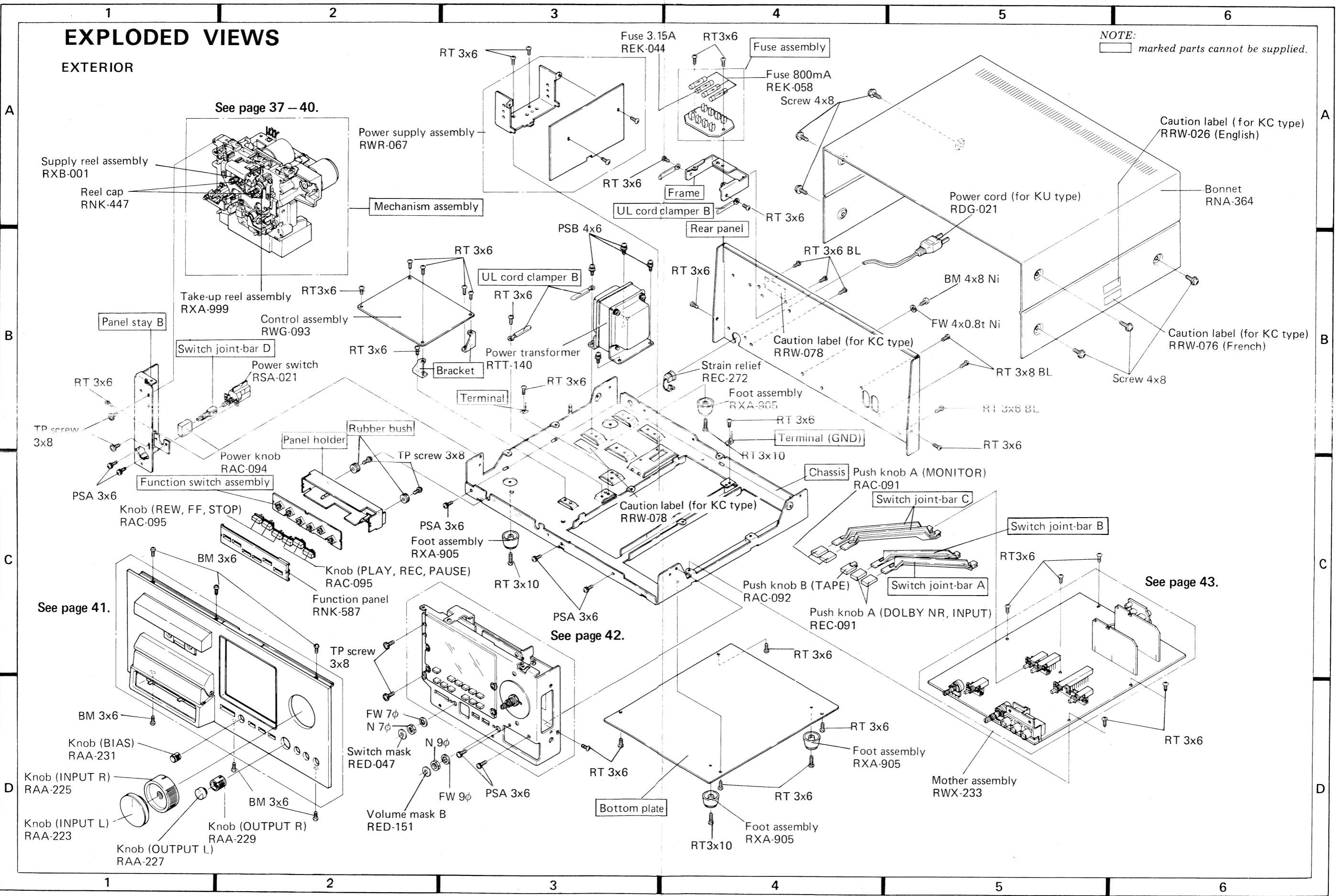

MECHANISM ASSEMBLY (FRONT SIDE)

NOTE: marked parts cannot be supplied.

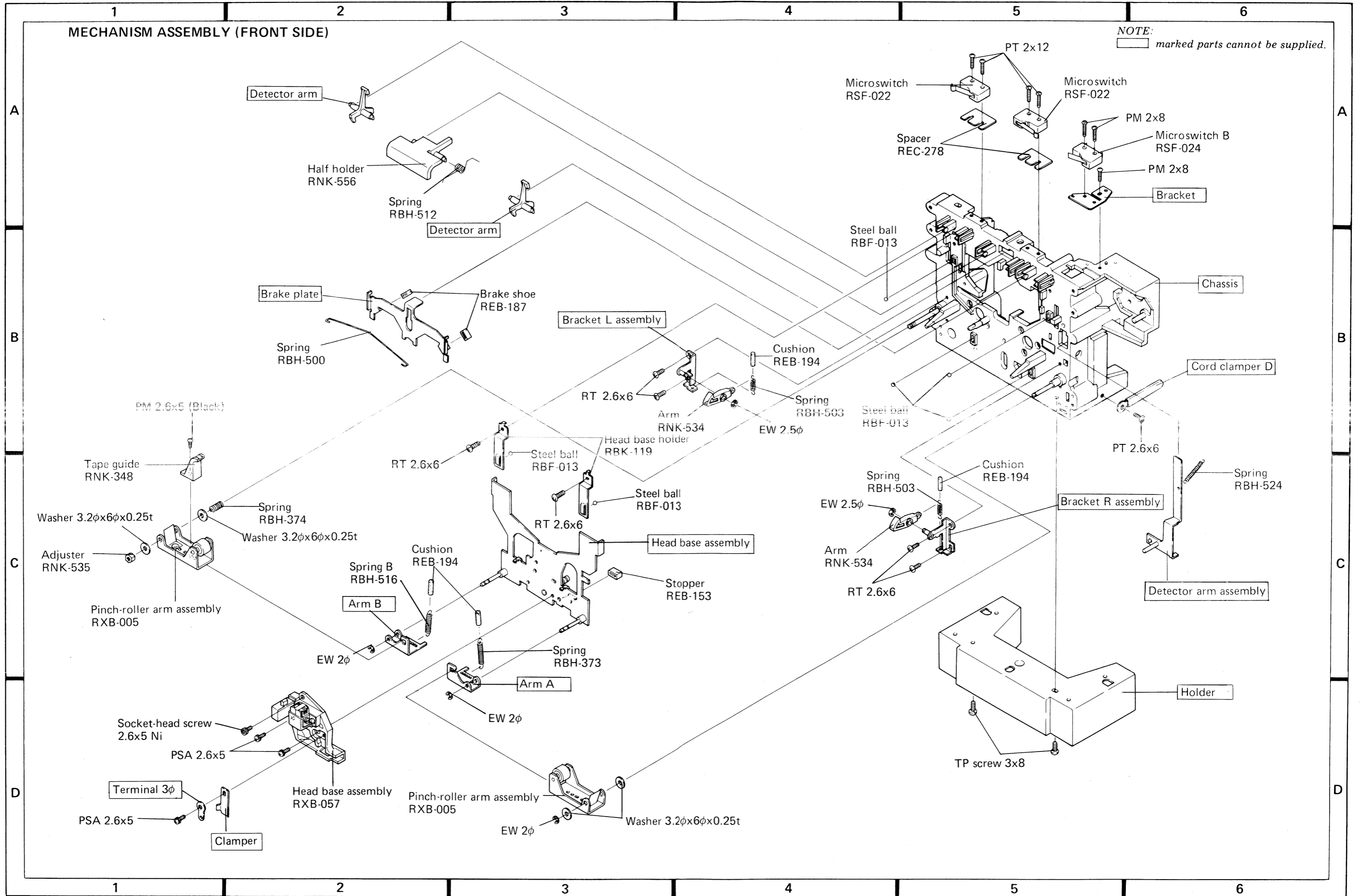

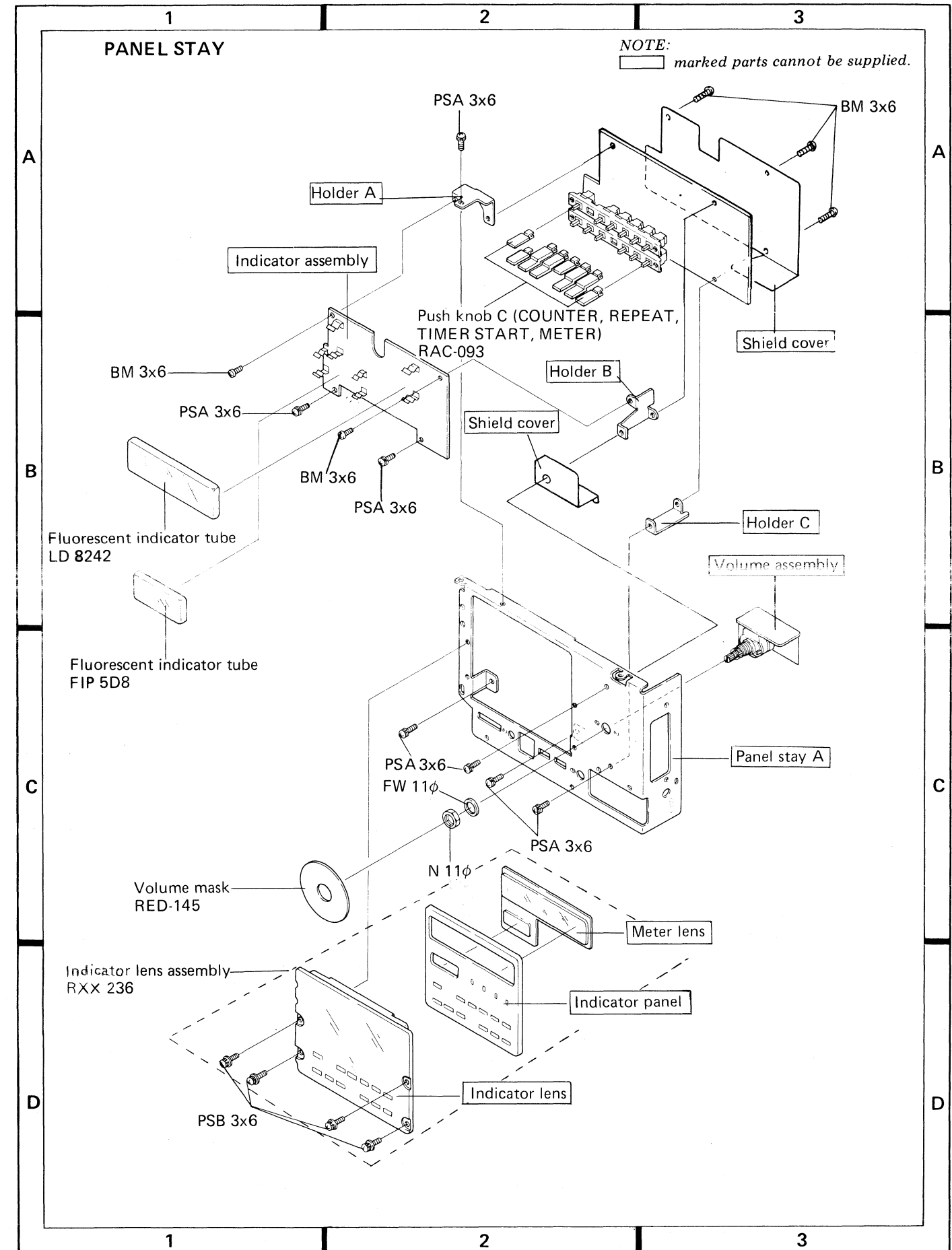
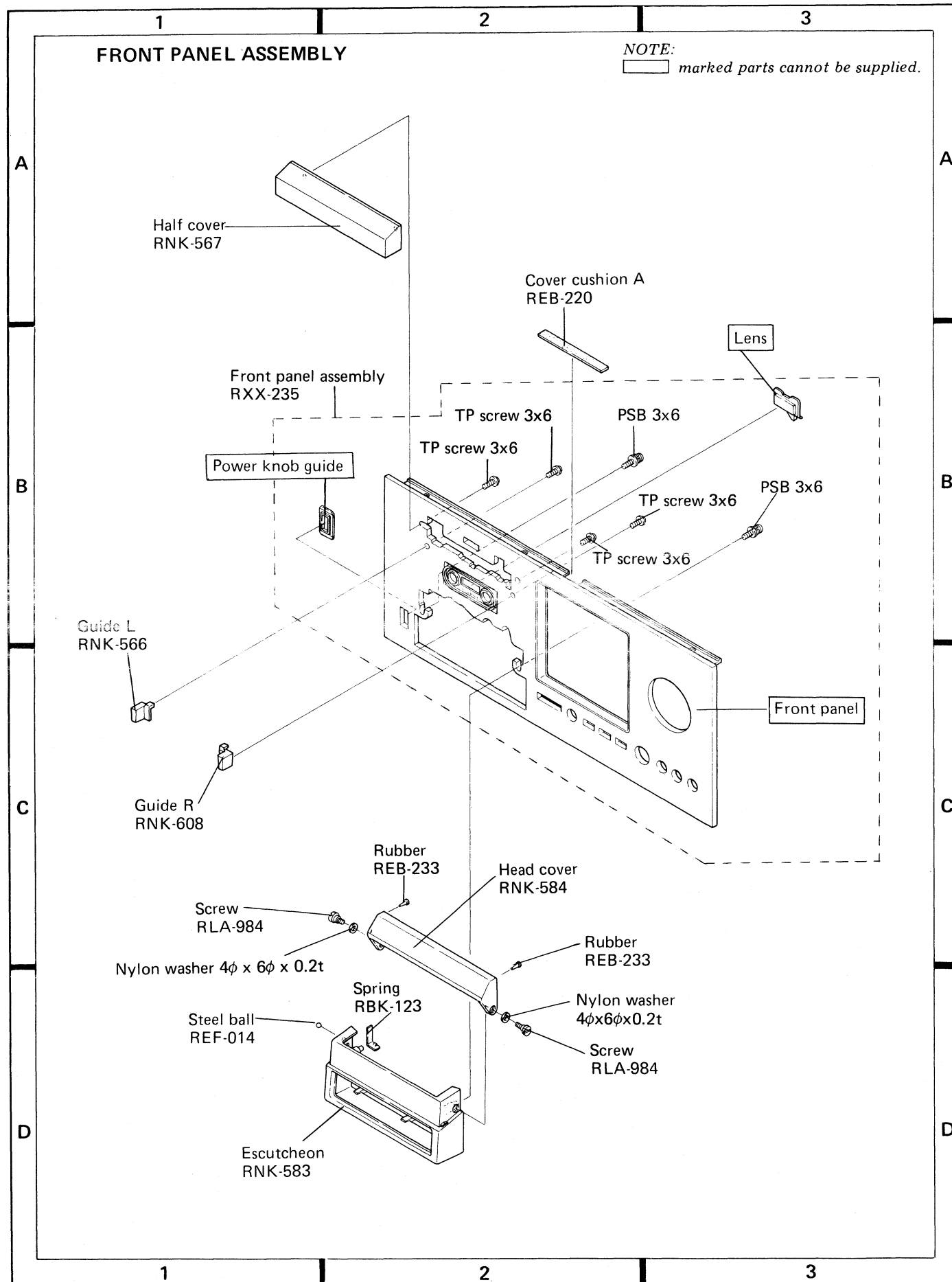

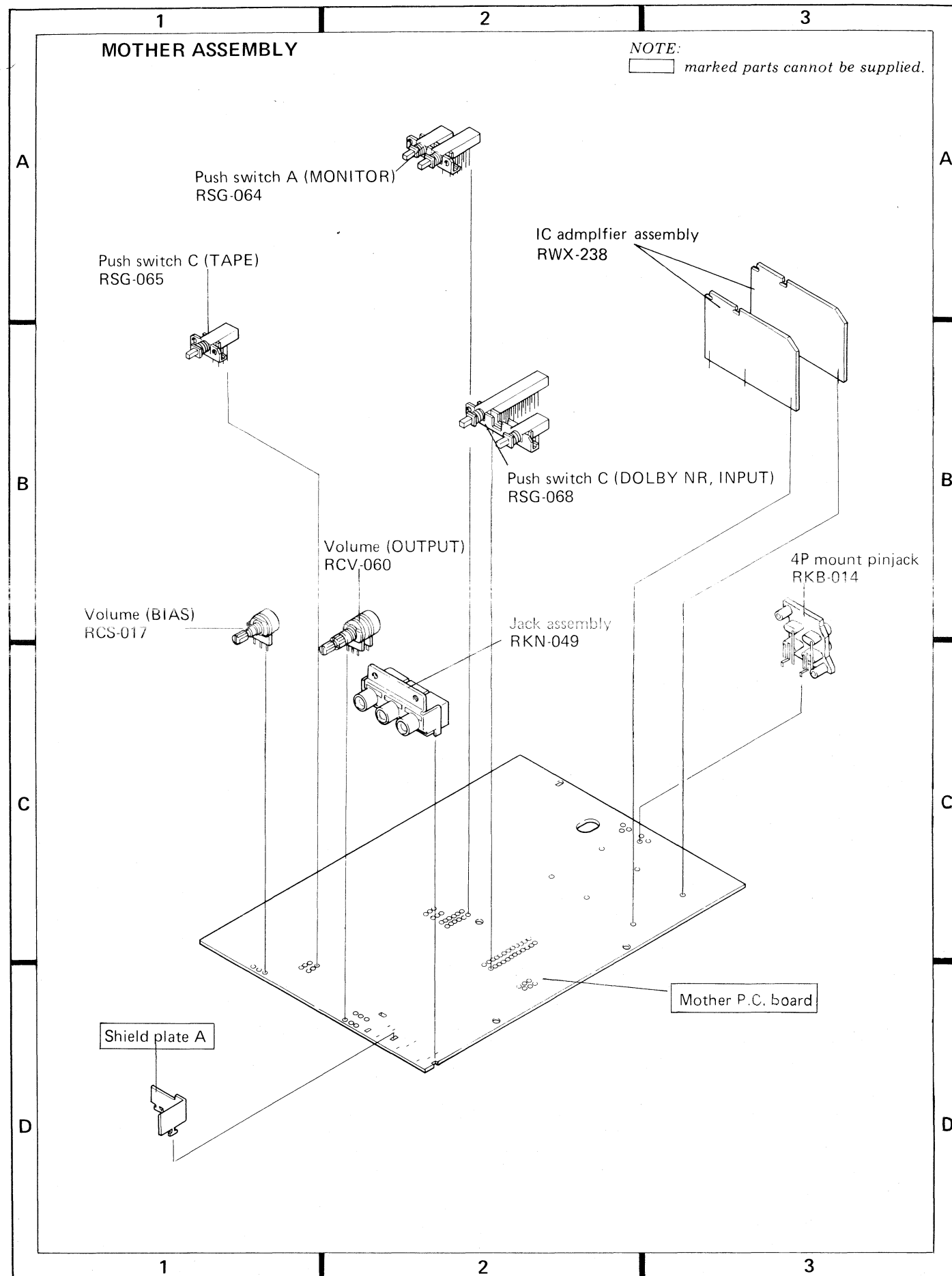

Appearance of Transistors and ICs

2SA733
2SC1740 LN

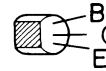

2SA934
2SC2060

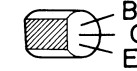

2SC620

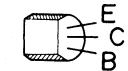

2SC1419
2SD234
2SD526
2SD686

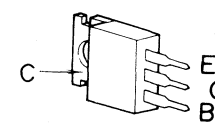

PA4001

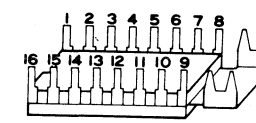

PA4002
μPD4050C

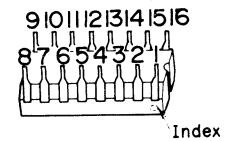

AN370

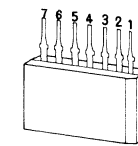

TA7318P

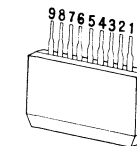

TC9121P

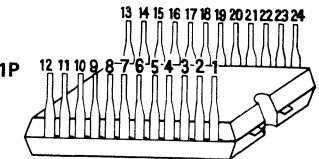

PD4004

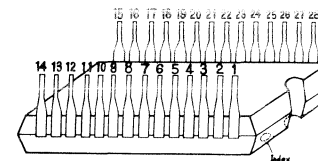

μPC324C

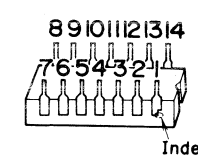

TLP507

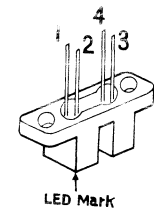

Block diagram of AN370

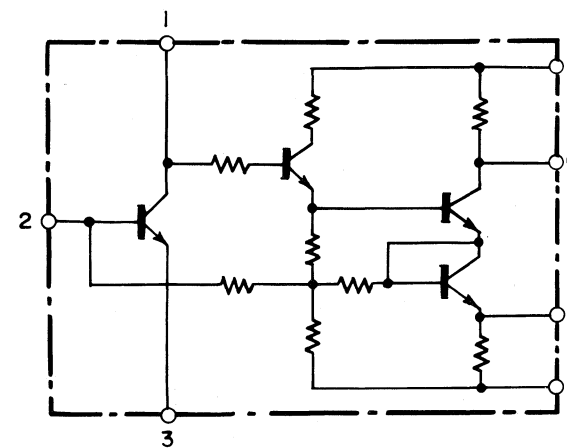

Block diagram of μPC324C

