

Service Manual

**CIRCUIT DESCRIPTIONS
REPAIR & ADJUSTMENTS**



**ORDER NO.
ARP-691-0**

STEREO AMPLIFIER

A-77X

MODEL A-77X COMES IN SEVEN VERSIONS DISTINGUISHED AS FOLLOWS:

Type	Voltage	Remarks	Black	Silver
KU	AC120V only	U.S.A. model	○	—
KC	AC120V only	Canada model	○	—
HE	AC220V, 240V (switchable)	European continent model	○	○
HB	AC220V, 240V (switchable)	United Kingdom model	○	—
S	AC110V, 120V, 220V, 240V (switchable)	General export model	○	—
S/G	AC110V, 120V, 220V, 240V (switchable)	U.S. Military model	○	—
HEZ	AC220V, 240V (switchable)	West Germany model	○	○

- This service manual is applicable to the KU type.
For servicing of the KC, HE, HB and S, S/G, HEZ types, please refer to the additional service manual.

CONTENTS

1. SPECIFICATIONS	2	6. EXPLODED VIEW AND PARTS LIST	9
2. FRONT PANEL FACILITIES	3	7. P.C. BOARDS CONNECTION DIAGRAM	14
3. BLOCK DIAGRAM	5	8. SCHEMATIC DIAGRAM	20
4. PACKING	6	9. ELECTRICAL PARTS LIST	23
5. PARTS LOCATION	7	10. SAFETY INFORMATION	27

1. SPECIFICATIONS

Amplifier Section

Continuous average power output is 100 watts* per channel, min., at 8 ohms from 20 Hertz to 20,000 Hertz with no more than 0.003% total harmonic distortion.

Total Harmonic Distortion	
(20 Hz to 20 kHz, 8 Ω, from CD)	
100 W per channel power output	No more than 0.003%
Cross-harmonic distortion (50 Hz : 7 kHz = 4 : 1)	
At effective output	0.003%
Output bandwidth (both channels driven)	
	5 Hz — 55 kHz (distortion 0.01%, 8 Ω)
Damping Factor (20 Hz to 20 kHz, 8 Ω)	
Input (Sensitivity/Impedance)	100
PHONO MM	2.5 mV/50 kΩ
PHONO MC	0.2 mV/100 Ω
TUNER, CD, AUX 1, 2, TAPE PLAY 1, 2	150 mV/30 kΩ
Phono Overload Level	
PHONO MM (T.H.D. 0.003%, 1 kHz)	200 mV
PHONO MC (T.H.D. 0.003%, 1 kHz)	16 mV
Cartridge load capacity/load impedance	
PHONO MM	220 pF/50 kΩ
Output (Level/Impedance)	
TAPE REC 1, 2	150 mV/2.2 kΩ
Frequency Response	
PHONO (RIAA Equalization) MM, MC	
	20 Hz to 20 kHz ±0.2 dB
TUNER, CD, AUX 1, 2, TAPE PLAY 1, 2	
	10 Hz — 100 kHz ±3 dB
Tone Control	
BASS	±8 dB (100 Hz)
TREBLE	±8 dB (10 kHz)
SUBSONIC filter	15 Hz (-6 dB/oct)
Muting	-20 dB
Hum and Noise (short circuited, A network)	
PHONO MM	88 dB
PHONO MC	70 dB
CD, AUX 1, 2, TUNER,	
TAPE PLAY 1, 2	108 dB
Speaker load impedance	
HE, HB, YP models	6 — 16 Ω
KU, KC, S, S/G models	4 — 16 Ω

Miscellaneous

Power Requirements	
HE model	a.c. 220 V ~, 50/60 Hz
HB, YP models	a.c. 240 V ~, 50/60 Hz
S, S/G models	~AC 110 V/120 V/220 V/240 V (switchable), 50/60 Hz
KU, KC models	AC 120 V, 60 Hz

Power Consumption	
KU model	530 W (UL)
KC model	650 VA (CSA)
Dimensions	
	457 (W) x 155 (H) x 427 (D) mm 18(W) x 6-1/8(H) x 16-3/4 (D) in
Weight (without package)	
	15.3 kg (33 lb 11 oz)

Furnished Parts

Operating Instructions	1
Side Panel	2
Side Panel mount screw	4

NOTE:

- Specifications and design subject to possible modification without notice due to improvements.
- *Measured pursuant to the Federal Trade Commission's Trade Regulation rule on Power Claims for Amplifiers.

QUESTIONNAIRE

MODEL _____

One Model per questionnaire

Dear Servicer,

Thank you for your cooperation in the post-sale service of Pioneer products.

This questionnaire is used as a tool to improve the serviceability of our products and service manuals. Please evaluate this model and service manual by answering the following questions. Your ideas may be realized in our future products. Your answers will be appreciated. Thank you.

PIONEER ELECTRONIC CORP.

T. Nakagawa, Manager, Service Section, International Division

1. SERVICING EVALUATION	Circle applicable number:	Good	Fair	Poor		
a. Disassembly/Re-assembly:		1	2	3	*4	*5
b. Circuit Checks:		1	2	3	*4	*5
c. Replacement of Parts:		1	2	3	*4	*5
d. Adjustment (s):		1	2	3	*4	*5

* If (4) or (5) was circled, please be specific.

e. Your advice, opinion or ideas related to servicing this product.

2. SERVICE MANUAL EVALUATION

a. Circuit & Mechanism Description

b. Circuit Diagram

3. OTHER

Please describe other areas of servicing which you may find difficult.

Completed by :

Date :

Company Name :

Address :

City/State/Zip :

Please send this form filled to the distributor in your country.

2. FRONT PANEL FACILITIES

FRONT PANEL

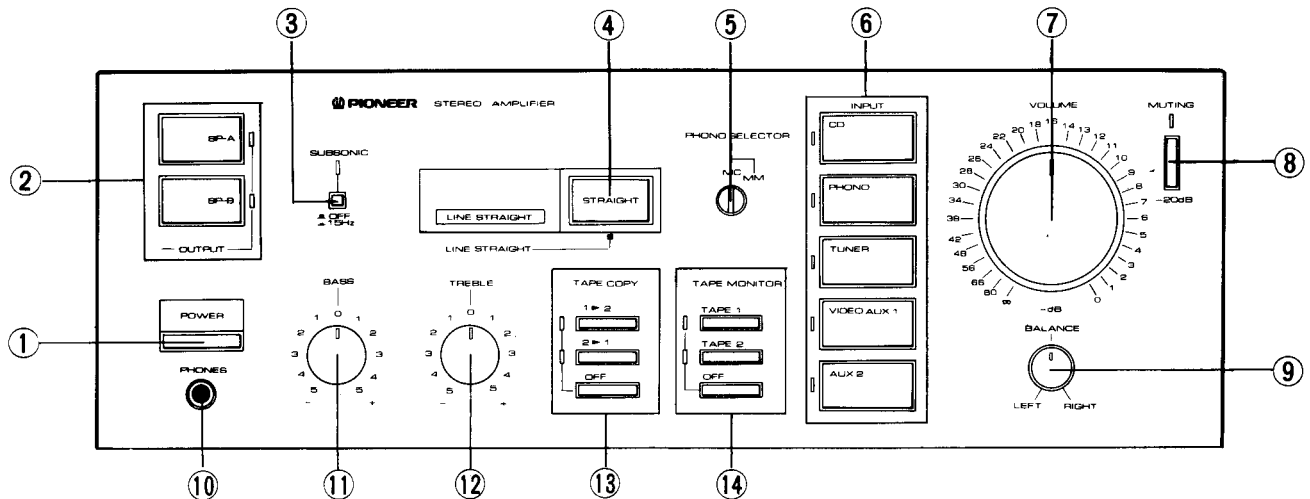

① POWER switch/indicator

Press to turn power to the unit ON and OFF.
 Depressed position (ON):
 Power is supplied to the unit.
 Released position (OFF):
 Power to the unit is disconnected.

② OUTPUT selector switches/indicators

Use to select the speaker systems used for playback.
 [SP-A]
 — Sound is produced from the speaker systems connected to the SPEAKERS A terminals.
 [SP-B]
 — Sound is produced from the speaker systems connected to the SPEAKERS B terminals.
 When the indicators are not lighted, the speaker systems are OFF, and no sound will be produced from them. Set to this position when using headphones.

③ SUBSONIC filter switch/indicator

Use this switch when playing records with coarse grooves.
 [OFF]
 — Released position; leave in this position for normal playback.
 [15Hz]
 — Depressed position; in this position, frequencies of 15Hz and below are cut, thus eliminating super-low-frequency noise caused by coarse record grooves, and thus helping prevent sound distortion.

④ LINE STRAIGHT switch/indicator

By using this switch, the input signals from the various connected peripheral components can be played back through the amplifier's modifying (tone) circuit, or bypassing those circuits.
 When the indicator is lighted, the function is ON. Input signals will bypass the modifying circuits and be played back with pure, flat-balanced tone.
 When set to OFF, input signals will pass through the modify-

ing circuits before being played back, thus allowing you to adjust bass and treble tone.

⑤ PHONO SELECTOR switch

Set in accordance with the type of cartridge used in your record turntable.
 [MC]
 — Set to this position when using an MC (moving coil) cartridge.
 [MM]
 — Set to this position when using an MM (moving magnet) cartridge, or an MC (moving coil) cartridge with high output of 1 mV or more.

⑥ FUNCTION switches/indicators

[CD]
 — Press when listening to a compact disc playback with a CD player.
 [PHONO]
 — Press when listening to record playback on a turntable.
 [TUNER]
 — Press when listening to AM or FM broadcasts with a tuner.
 [VIDEO/AUX 1]
 — Press when listening to programs from a component connected to the VIDEO SOUND/AUX 1 terminals.
 [AUX 2]
 — Press when listening to programs from a component connected to the AUX 2 terminals.

⑦ VOLUME control

These are used for controlling the sound volume.
 When set to the [∞] position, sound volume is turned off; when set to the [0] position, sound volume is at a maximum.

⑧ MUTING switch/indicator

Use to temporarily cut sound volume.
 When pressed ON, indicator will light, and sound volume will be cut by 20 dB. When set to OFF, the sound will return to its previous volume.

⑨ BALANCE control

Should normally be left in the center position. Adjust balance if the sound is louder from one of the speakers. If the right side is louder, turn toward the (L) position and if the left side is louder, turn toward the (R) position.

⑩ PHONES jack

When using headphones, insert their plug into this jack.

⑪ BASS tone control

Use to adjust the low-frequency tones. The central "0" position is the flat (normal) position. When turned to the right, low-frequency tones are emphasized; when turned to the left, low-frequency tones are de-emphasized.

This function does not operate when the LINE STRAIGHT switch is in the ON position.

⑫ TREBLE tone control

Use for adjusting the high-frequency tones.

The central "0" position is the flat (normal) position. When turned to the right, high-frequency tones are emphasized; when turned to the left, high-frequency tones are de-emphasized.

This function does not operate when the LINE STRAIGHT switch is in the ON position.

⑬ TAPE COPY switch/indicator

Use when performing tape copying between two tape decks connected to the amplifier.

[1 ► 2]

- Set in this position when performing tape copying from the tape deck connected to the TAPE 1 PLAY terminals to the deck connected to the TAPE 2 REC terminals.

[OFF]

- Leave set in this position when not performing tape copying.

[2 ► 1]

- Set in this position when performing tape copying from the tape deck connected to the TAPE 2 PLAY terminals to the deck connected to the TAPE 1 REC terminals.

⑭ TAPE MONITOR switch/indicator

Use this switch to listen to tape playback, or to listen to the sounds being recorded during tape recording.

[TAPE 1]

- Set to this position to listen to the playback sound of the tape deck connected to the TAPE 1 PLAY terminals, or to monitor the sound being recorded on the tape deck connected to the TAPE 1 REC terminals.

[OFF]

- Leave set in this position when not listening to tape playback.

[TAPE 2]

- Set to this position to listen to the playback sound of the tape deck connected to the TAPE 2 PLAY terminals, or to monitor the sound being recorded on the tape deck connected to the TAPE 2 REC terminals.

Accessories

Wood-grain side panel x 2
Side panel mount screw x 4

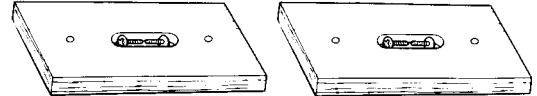

3. BLOCK DIAGRAM

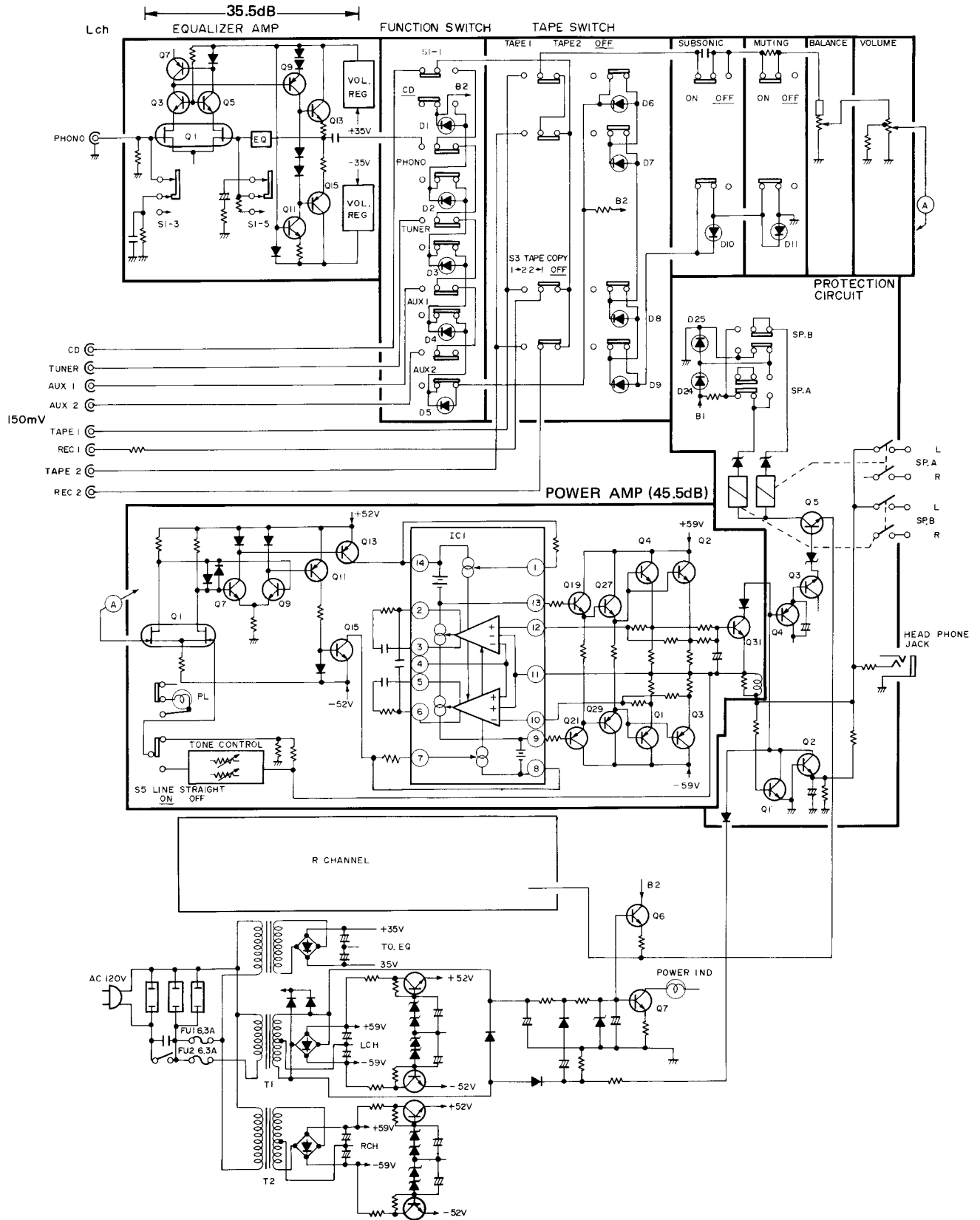

4. PACKING

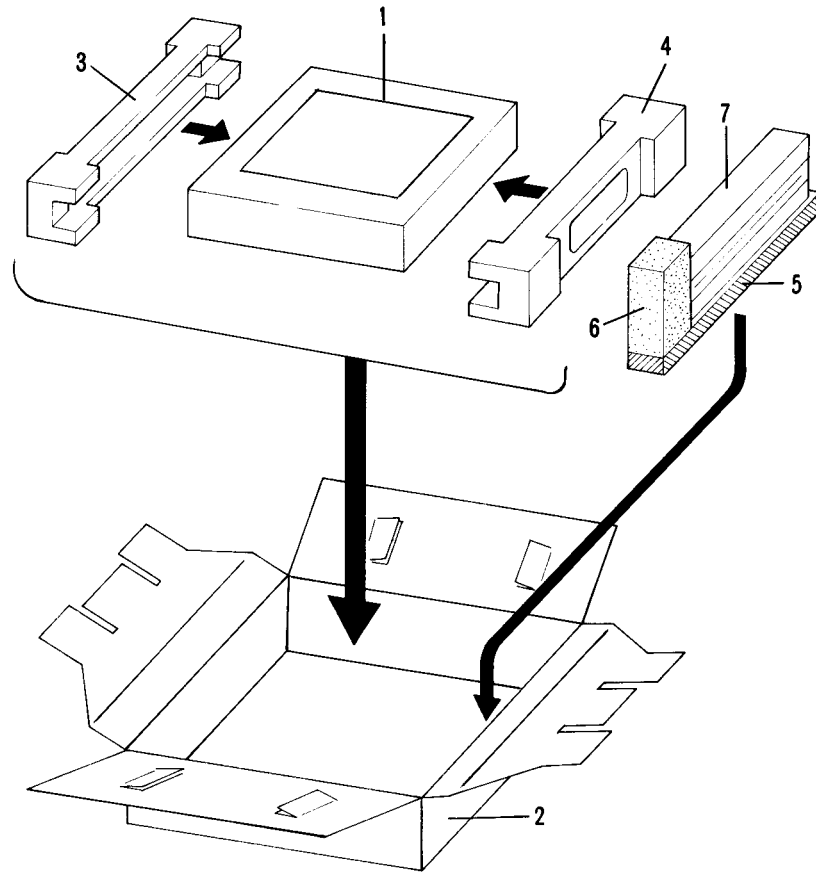

Mark	No.	Part No.	Description
	1.	ARB-660	Operating instructions (English)
	2.	AHE-517	Packing case
	3.	AHA-328	Side pad (L)
	4.	AHA-329	Side pad (R)
	5.	AHB-149	Protector A
	6.	AHB-150	Protector B
	7.	AMS-057	Side board assembly

5. PARTS LOCATION

NOTES:

- Parts without part number cannot be supplied.
- The **⚠** mark found on some component parts indicates the importance of the safety factor of the part. Therefore, when replacing, be sure to use parts of identical designation.
- For your Parts Stock Control, the fast moving items are indicated with the marks **★★** and **★**.
★★ GENERALLY MOVES FASTER THAN ★.
 This classification shall be adjusted by each distributor because it depends on model number, temperature, humidity, etc.

Front Panel View

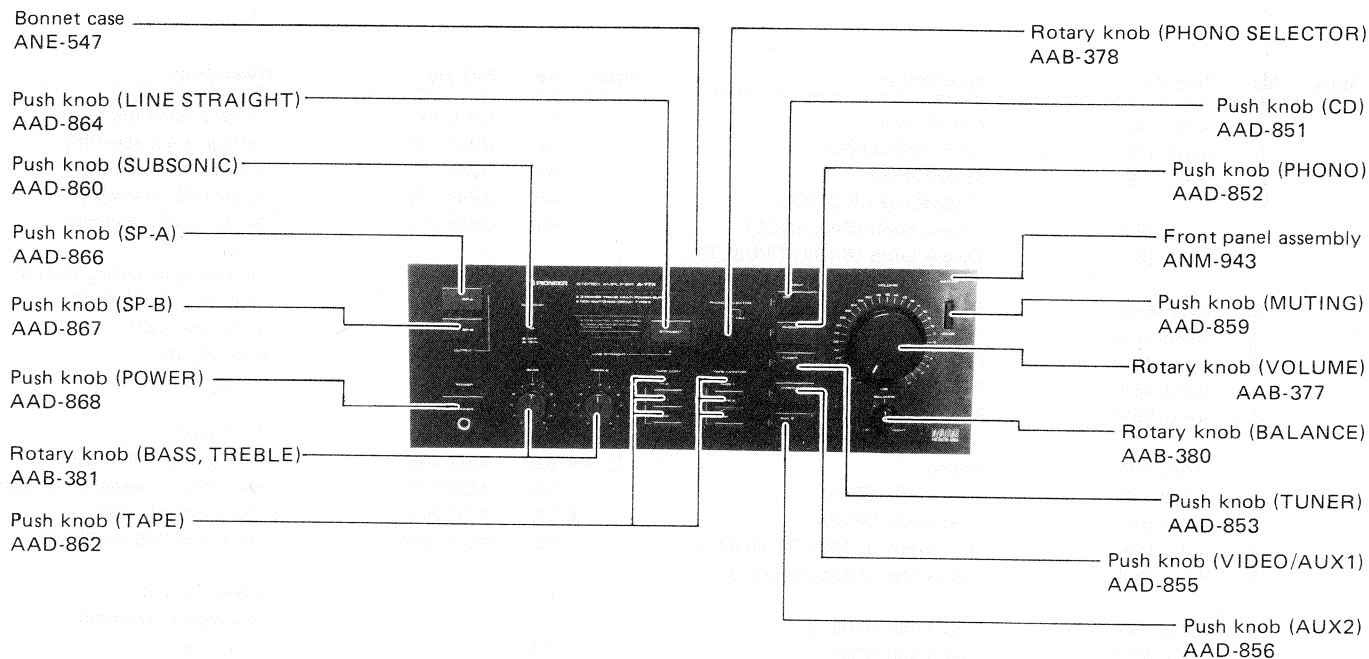

Front View with Panel Removed

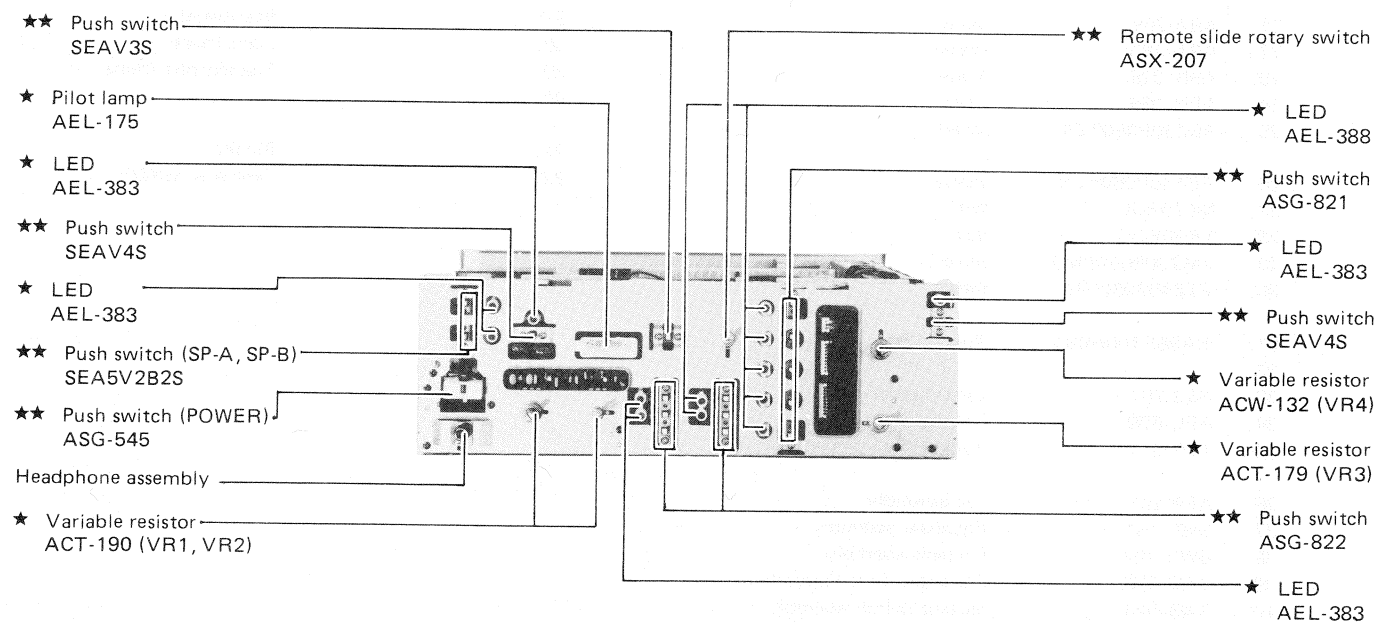

Rear Panel View

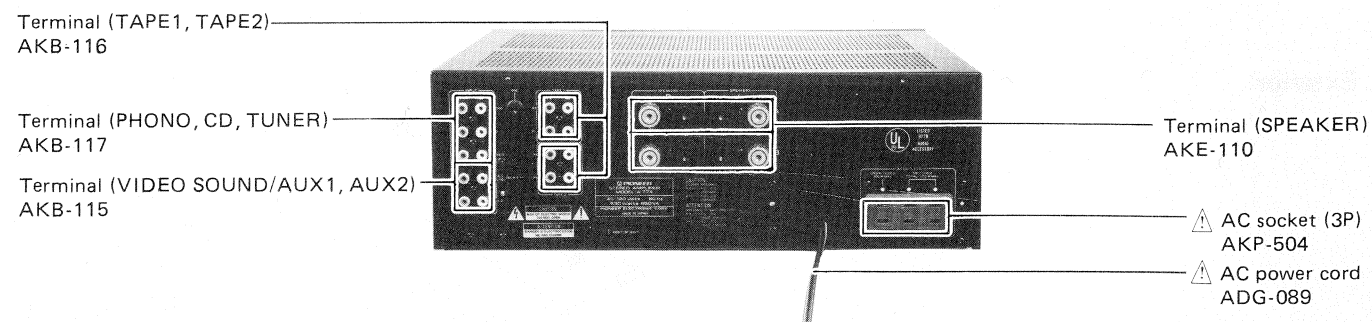

Top View

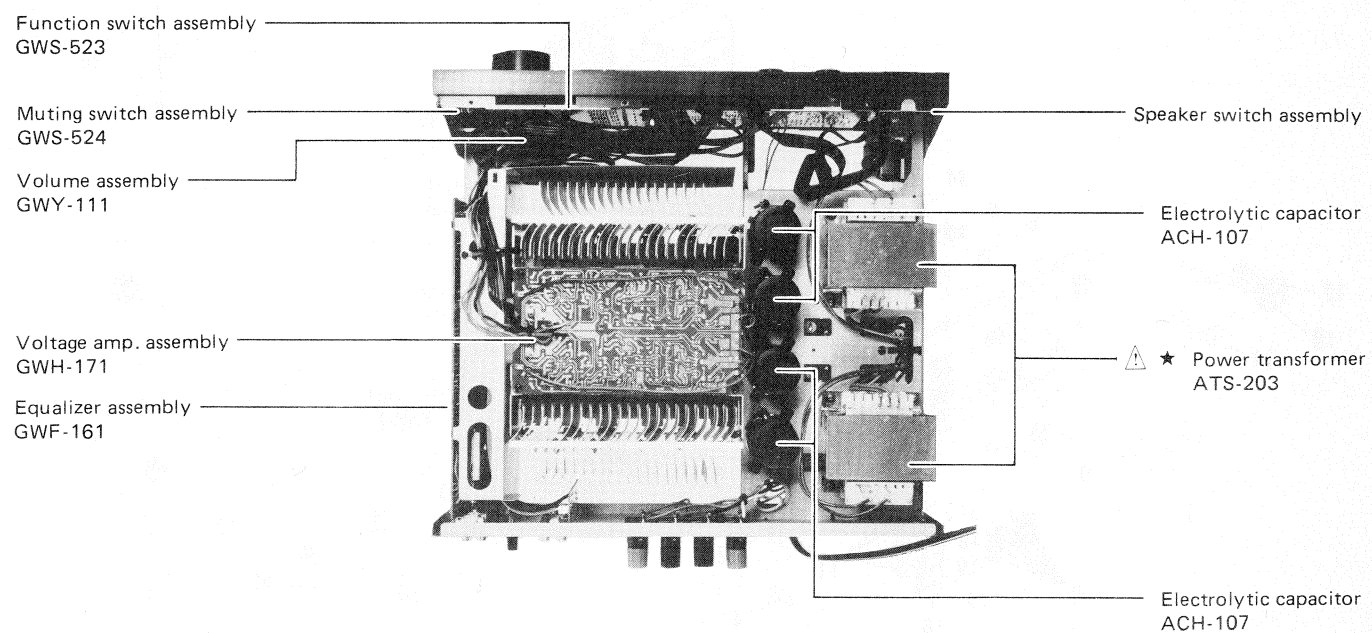

Bottom View

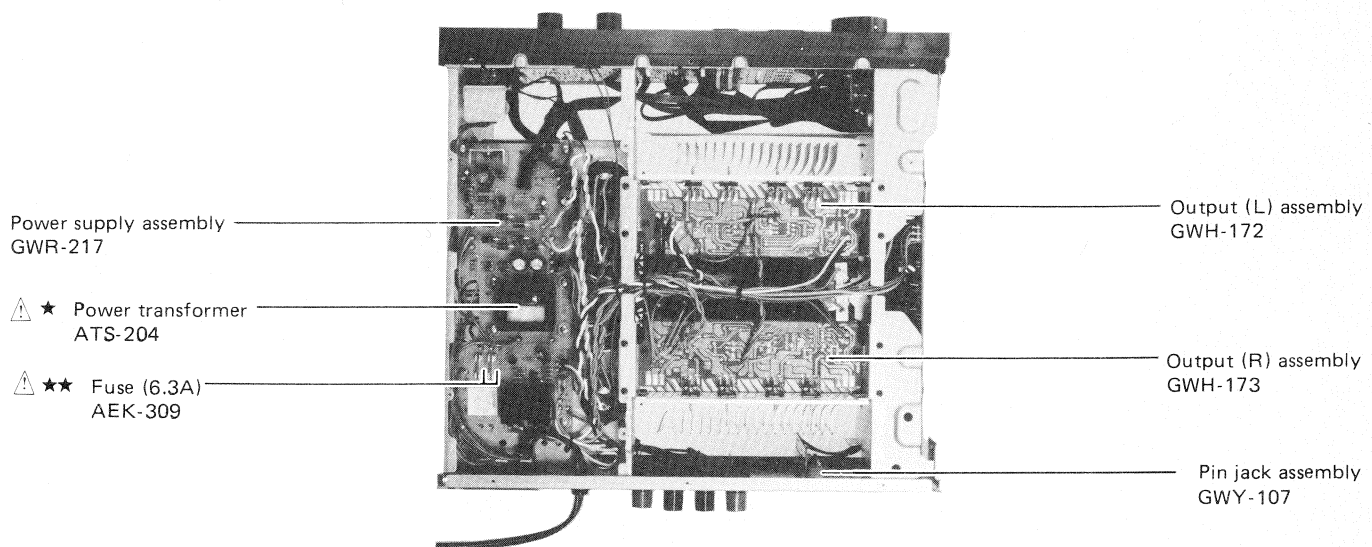

6. EXPLODED VIEW AND PARTS LIST

Exterior

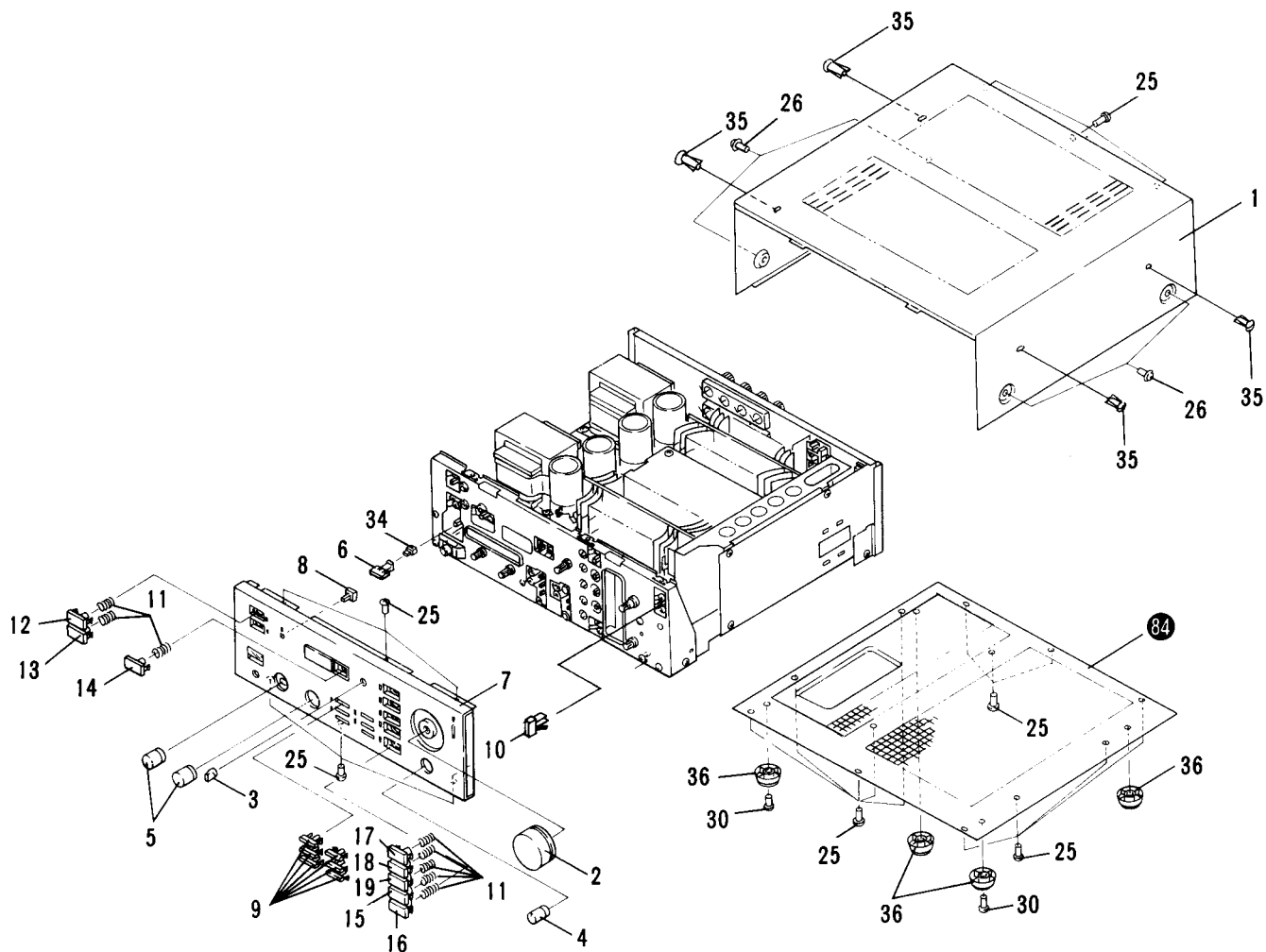

NOTES:

- *Parts without part number cannot be supplied.*
- *The \triangle mark found on some component parts indicates the importance of the safety factor of the part. Therefore, when replacing, be sure to use parts of identical designation.*
- *For your Parts Stock Control, the fast moving items are indicated with the marks **★★** and **★**.*
★★ GENERALLY MOVES FASTER THAN ★.
This classification shall be adjusted by each distributor because it depends on model number, temperature, humidity, etc.

Mark	No.	Part No.	Description	Mark	No.	Part No.	Description
	1.	ANE-547	Bonnet case		41.	GWY-111	Volume assembly
	2.	AAB-377	Knob (VOLUME)		42.	GWH-171	Voltage amp. assembly
	3.	AAB-378	Rotary knob (PHONO-SELECTOR)		43.	GWH-172	Output (L) assembly
	4.	AAB-380	Rotary knob (BALANCE)		44.	GWH-173	Output (R) assembly
	5.	AAB-381	Rotary knob (BASS, TREBLE)		45.	GWR-217	Power supply assembly
	6.	AAD-868	Push knob (POWER)		46.	ASX-207	Remote slide rotary switch
	7.	ANM-943	Front panel assembly	\triangle	47.	AKE-110	Terminal (SPEAKER)
	8.	AAD-860	Push knob (SUB)	\triangle	★★ 48.	AKP-504	AC socket (3P)
	9.	AAD-862	Push knob (TAPE)		★ 49.	AEK-309	Fuse (6.3A)
	10.	AAD-859	Push knob (MU)		50.	AEC-716	Lamp cap
	11.	ABH-135	Spring	\triangle	51.	AEL-161	Pilot lamp
	12.	AAD-866	Push knob (SP-A)	★★ 52.	ASG-545	Push switch (POWER)	
	13.	AAD-867	Push knob (SP-B)		53.	ACH-107	Electrolytic capacitor (8200/63V)
	14.	AAD-864	Push knob (LINE STRAIGHT)	\triangle	★ 54.	ATS-203	Power transformer
	15.	AAD-855	Push knob (VIDEO/AUX1)	\triangle	55.	ACG-502	Capacitor (0.01/AC250V)
	16.	AAD-856	Push knob (AUX2)		81.		Speaker switch
	17.	AAD-851	Push knob (CD)		82.		Headphone assembly
	18.	AAD-852	Push knob (PHONO)		83.		Front stay
	19.	AAD-853	Push knob (TUNER)		84.		Bottom plate
\triangle	20.	ADG-089	AC Power code		85.		Mount plate
	21.	ABA-258	Screw		86.		Power switch holder
	22.	ABA-283	Screw		87.		Rear panel
	23.	ABN-028	Screw		88.		Light frame
	24.	ABN-088	Screw		89.		Transformer frame
	25.	BBZ30P080FZK	Screw		90.	
	26.	FBT40P080FZK	Screw		91.		Binder
	27.	NK70FUC	Nut		92.		Terminal (GND)
	28.	NK90FUC	Nut				
	29.	VMZ30P060FMC	Screw				
	30.	VTZ40P080FMC	Screw				
	31.	WA35F100N080	Screw				
	32.				
	33.	AEB-257	Lamp holder				
	34.	AEC-800	Flexible ring				
	35.	AEP-211	Nylon rivet				
	36.	AEP-251	Leg assembly				
	37.	GWF-161	Equalizer assembly				
	38.	GWY-107	Pin jack assembly				
	39.	GWS-523	Function switch assembly				
	40.	GWS-524	Muting switch assembly				

Interior

Heat Sink

A

A

B

B

C

C

D

D

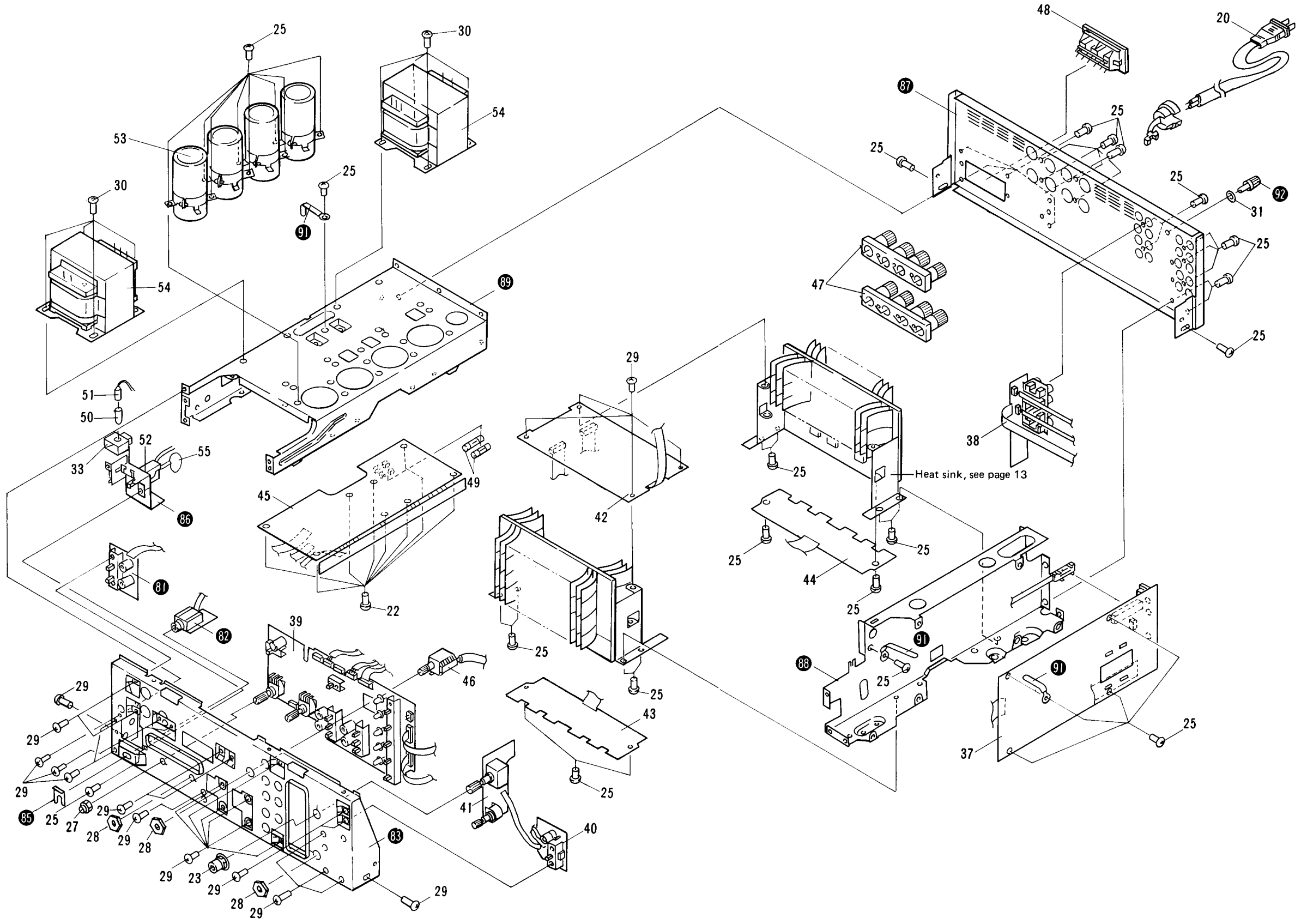

Parts List o

Mark	No.
	1.
	2.
	3.
▲	★★ 4.
▲	★★ 5.
	50.
	51.
	52.

Heat Sink

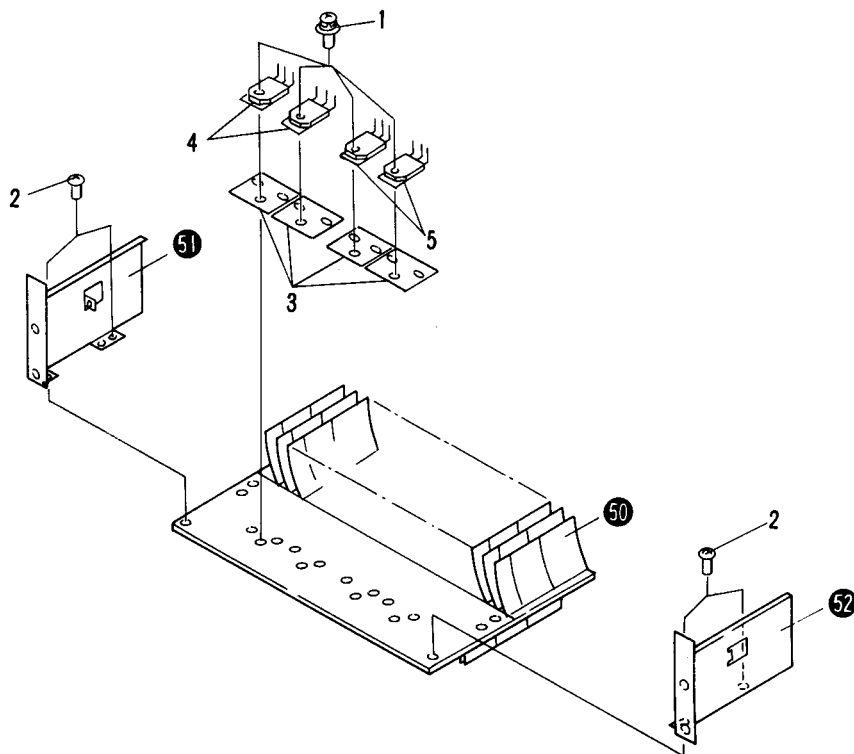

Parts List of Heat Sink

Mark	No.	Part No.	Description
	1.	ABA-258	Screw
	2.	BBZ30P080FZK	Screw
	3.	AEC-818	Mica sheet
⚠	★★ 4.	2SA1104A(A)-O/P/Y*	Power transistor
⚠	★★ 5.	2SC2579A(A)-O/P/Y*	Power transistor
	50.		Heat sink
	51.		Heat sink holder L
	52.		Heat sink holder R

*hfe should have the same value

7. P.C. BOARDS CONNECTION DIAGRAM

A

B

C

D

EQUALIZER ASSEMBLY (GWF-161)

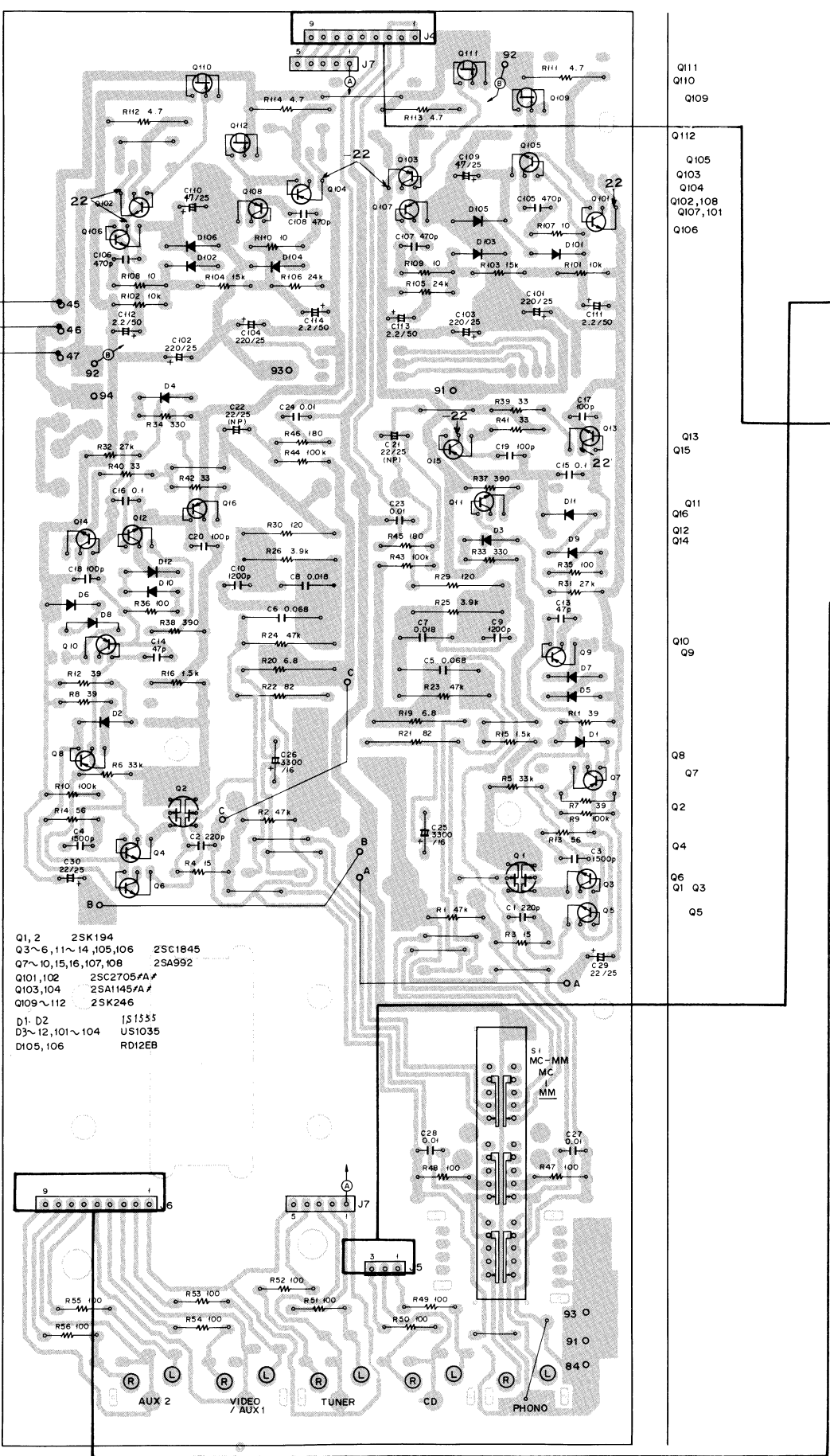

FUNCTION ASSEMBLY (GWS-523)

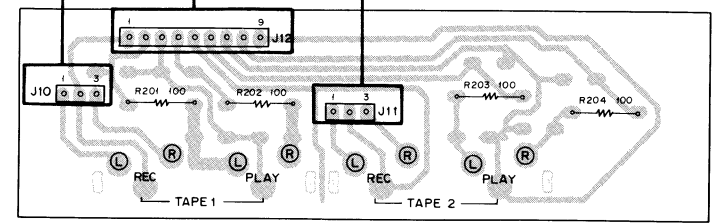
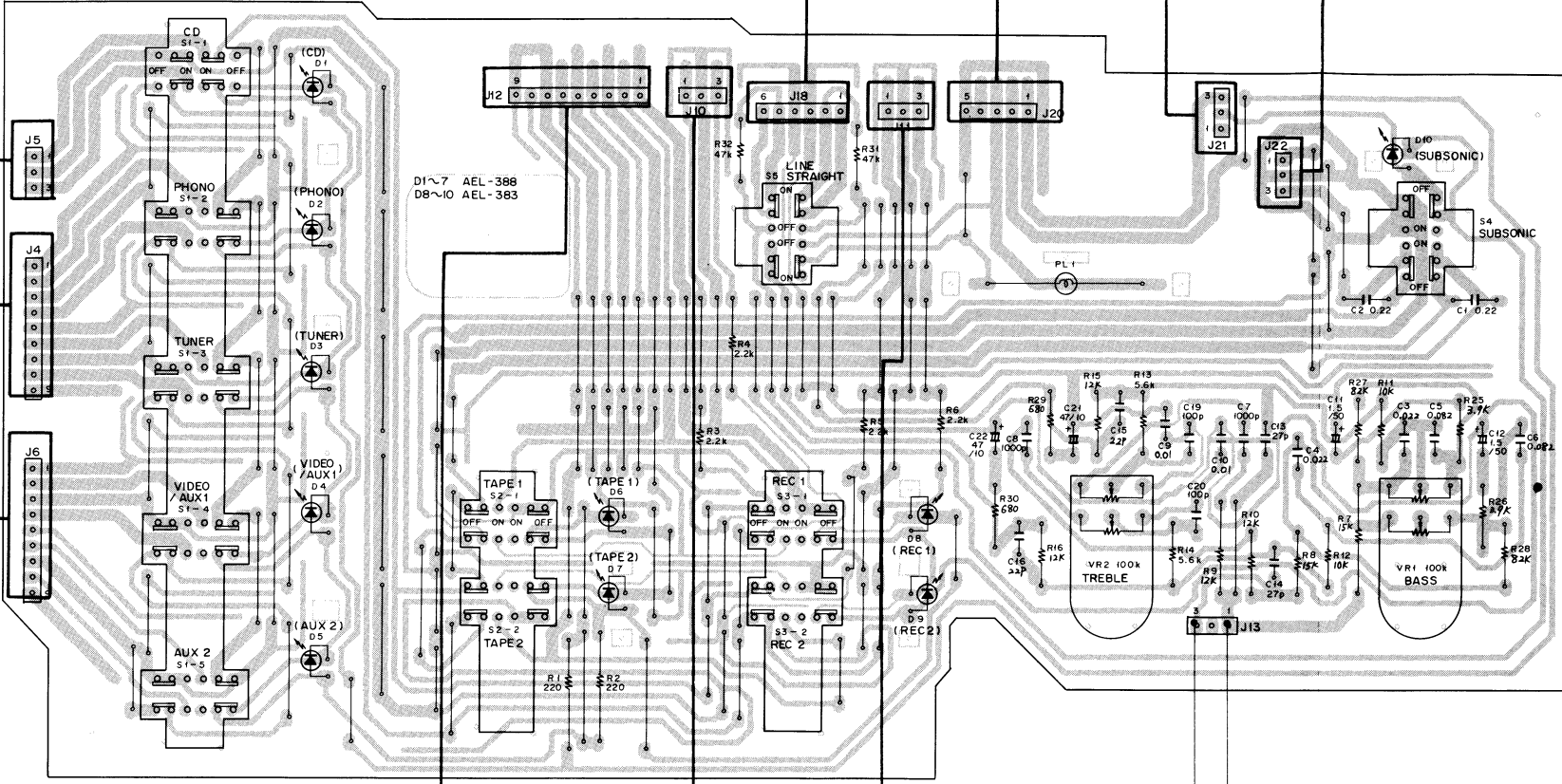

PIN JACK ASSEMBLY (GWY-107)

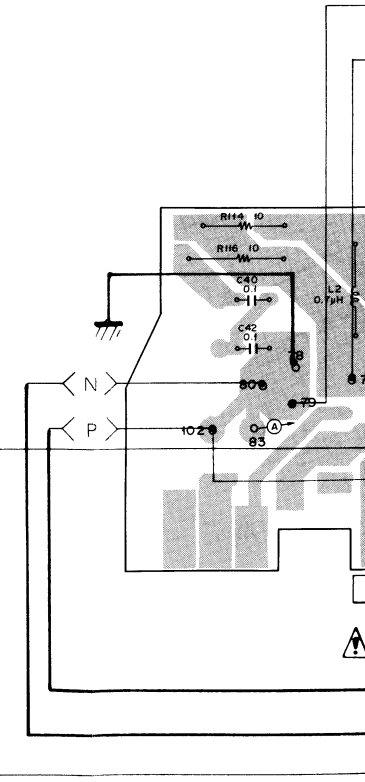

4

5

6

7

8

9

A
B
C

A

B

C

D

FUNCTION ASSEMBLY (GWS-523)

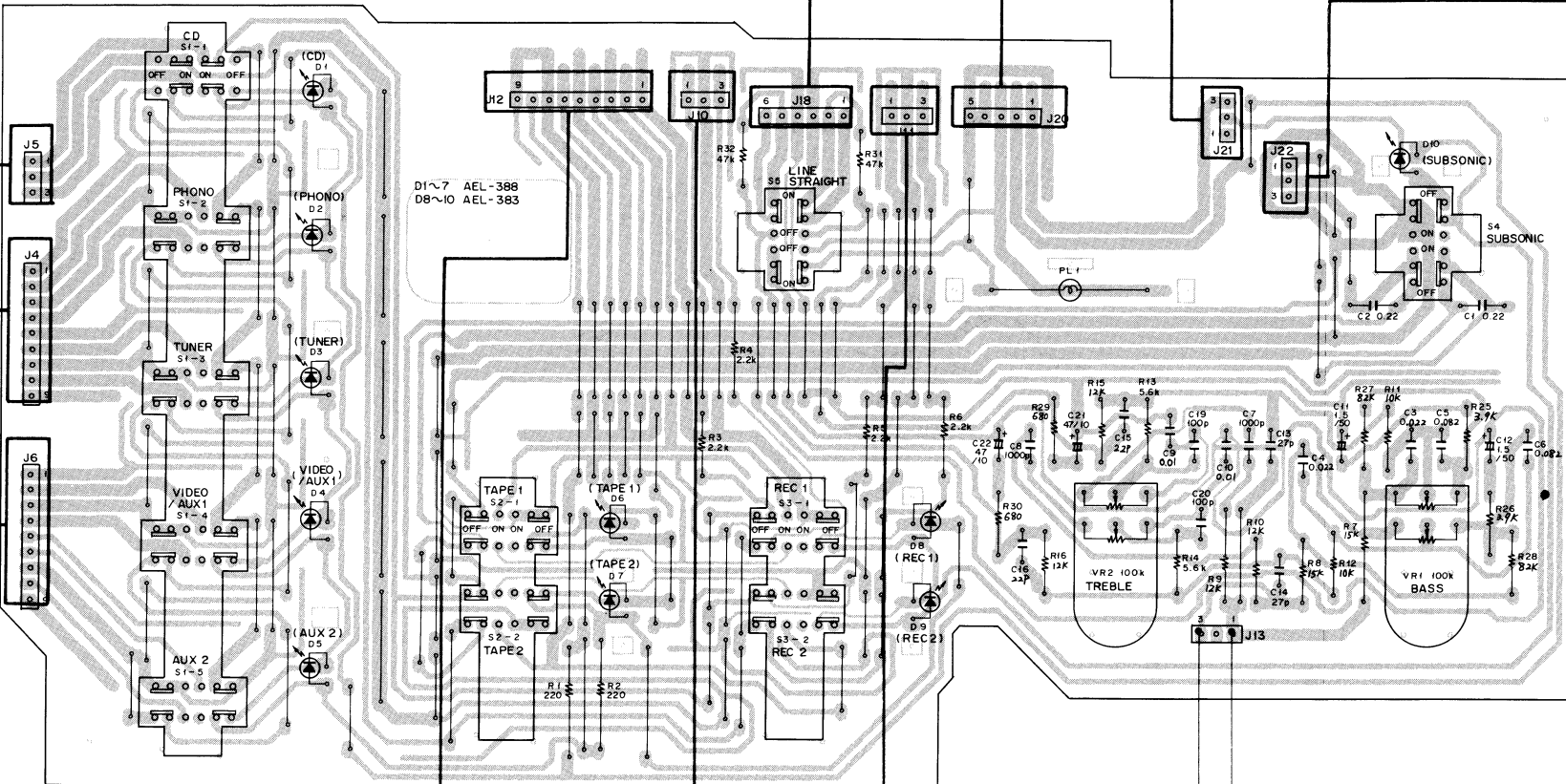

MUTING SWITCH ASSEMBLY

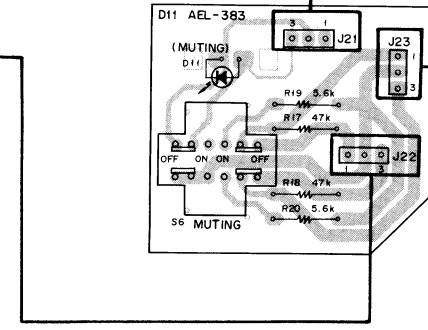

VOLUME ASSEMBLY (GWY-111)

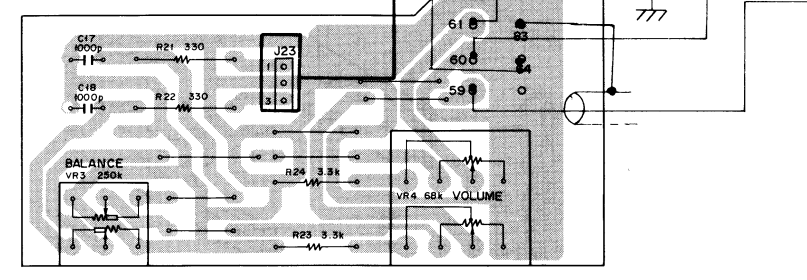

PIN JACK ASSEMBLY (GWY-107)

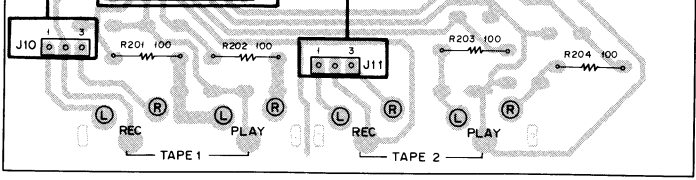

R OUTPUT ASSEMBLY (GWH-173)

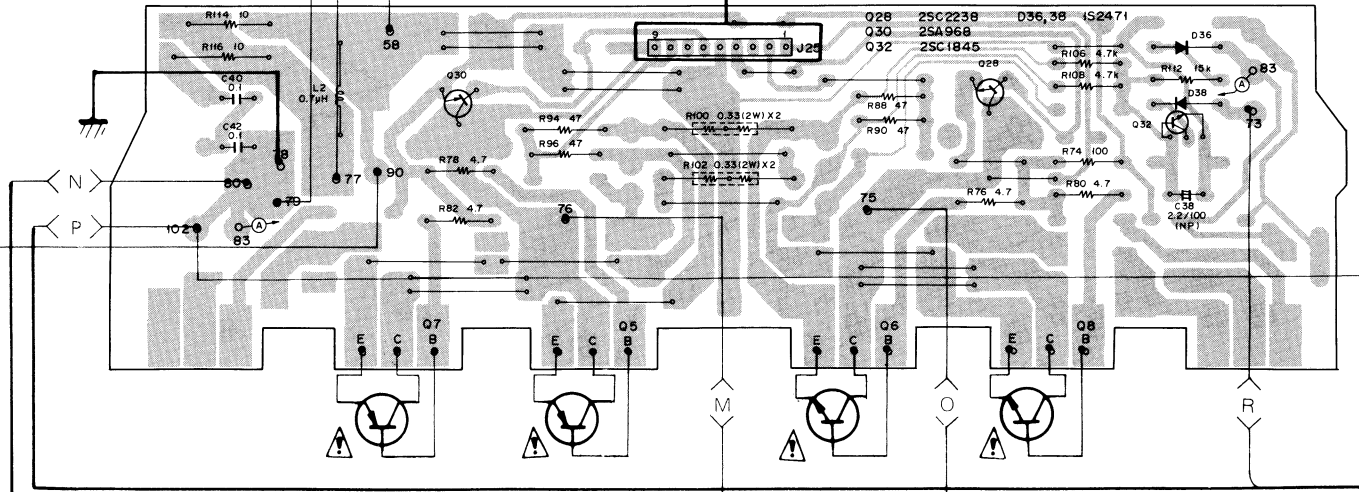

4

5

6

7

8

9

N
O
P

1

2

3

4

5

6

7

VOLTAGE AMPLIFIER ASSEMBLY (GWH-171)

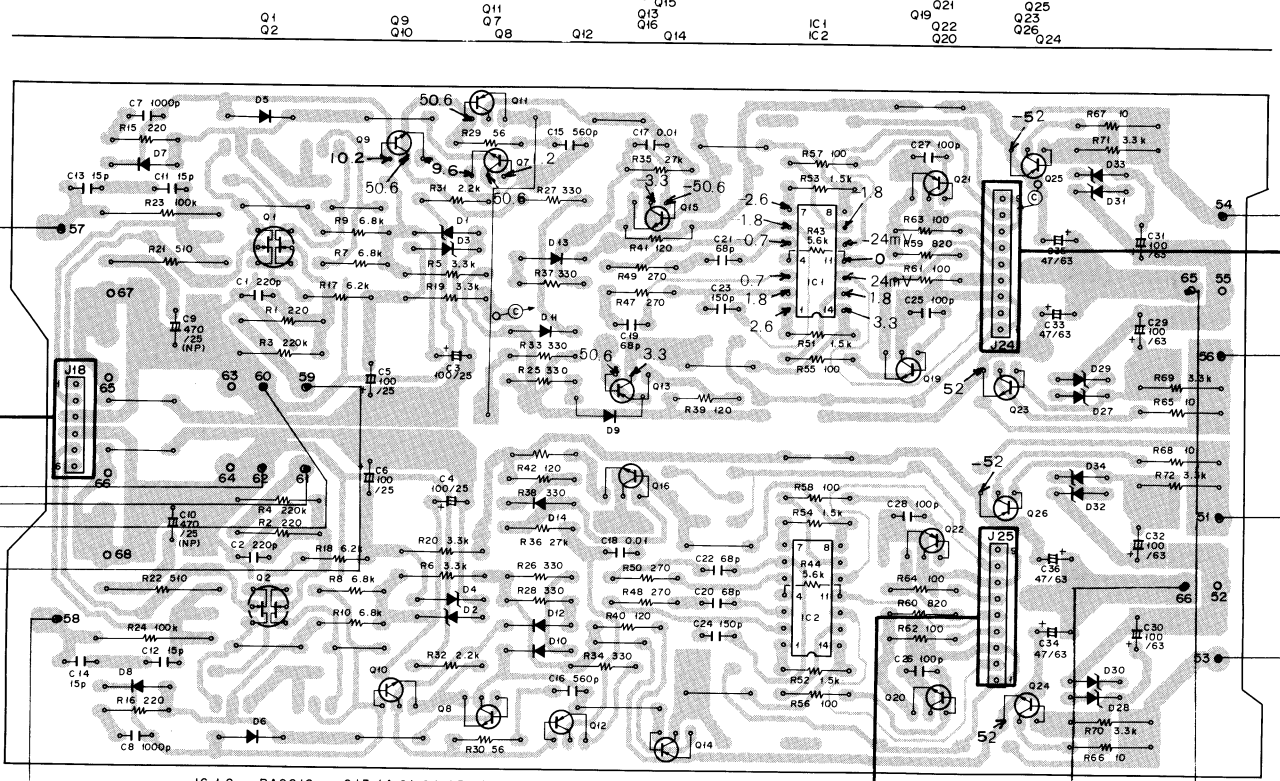

L OUTPUT ASSEMBLY (GWH-172)

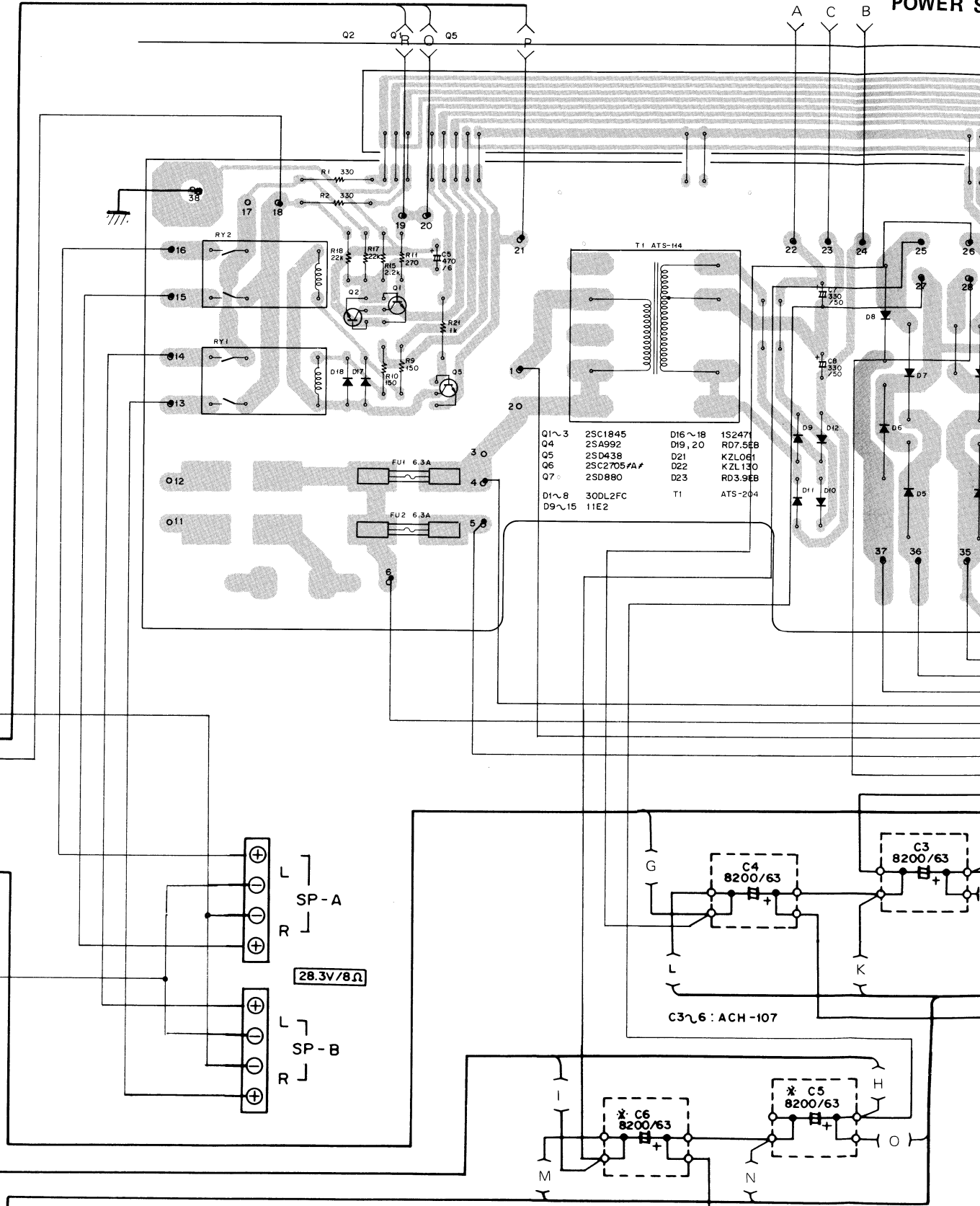
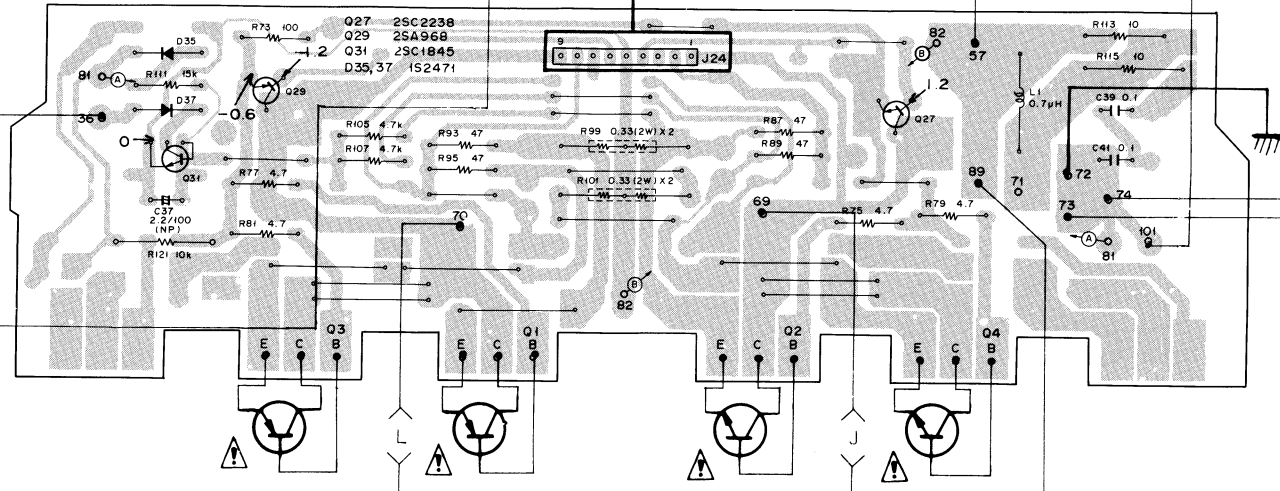

POWER SUPPLY

A
B
C
D
E
F
G
H
I
J
K
L
M
N
O
P

1

2

3

4

5

6

7

3

4

5

6

7

8

6

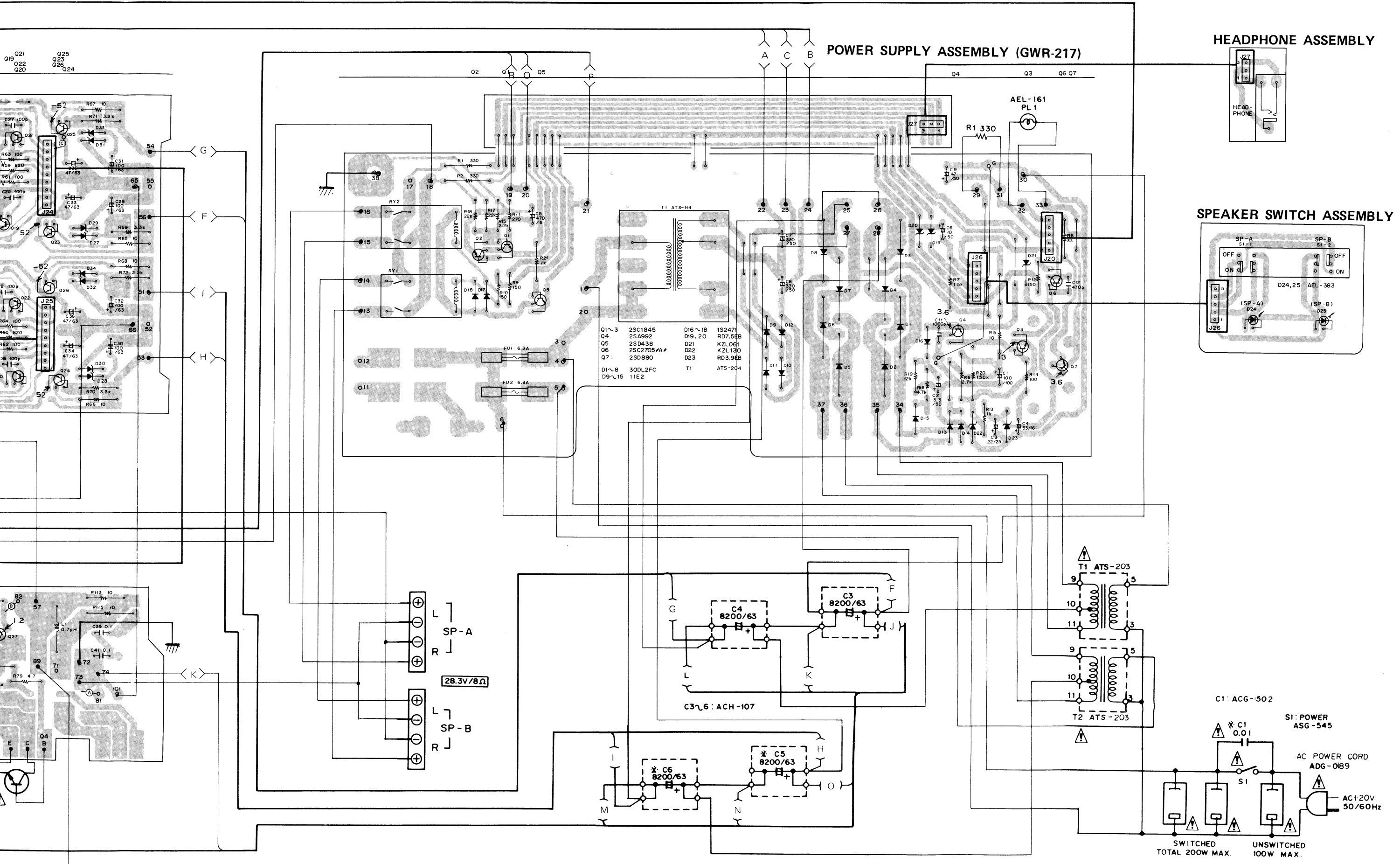

A

B

C

D

3

4

5

6

7

8

9

8. SCHEMATIC DIAGRAM

NOTE:
The indicated semiconductors are representative ones only. Other alternative semiconductors may be used and are listed in the parts list.

A

B

C

D

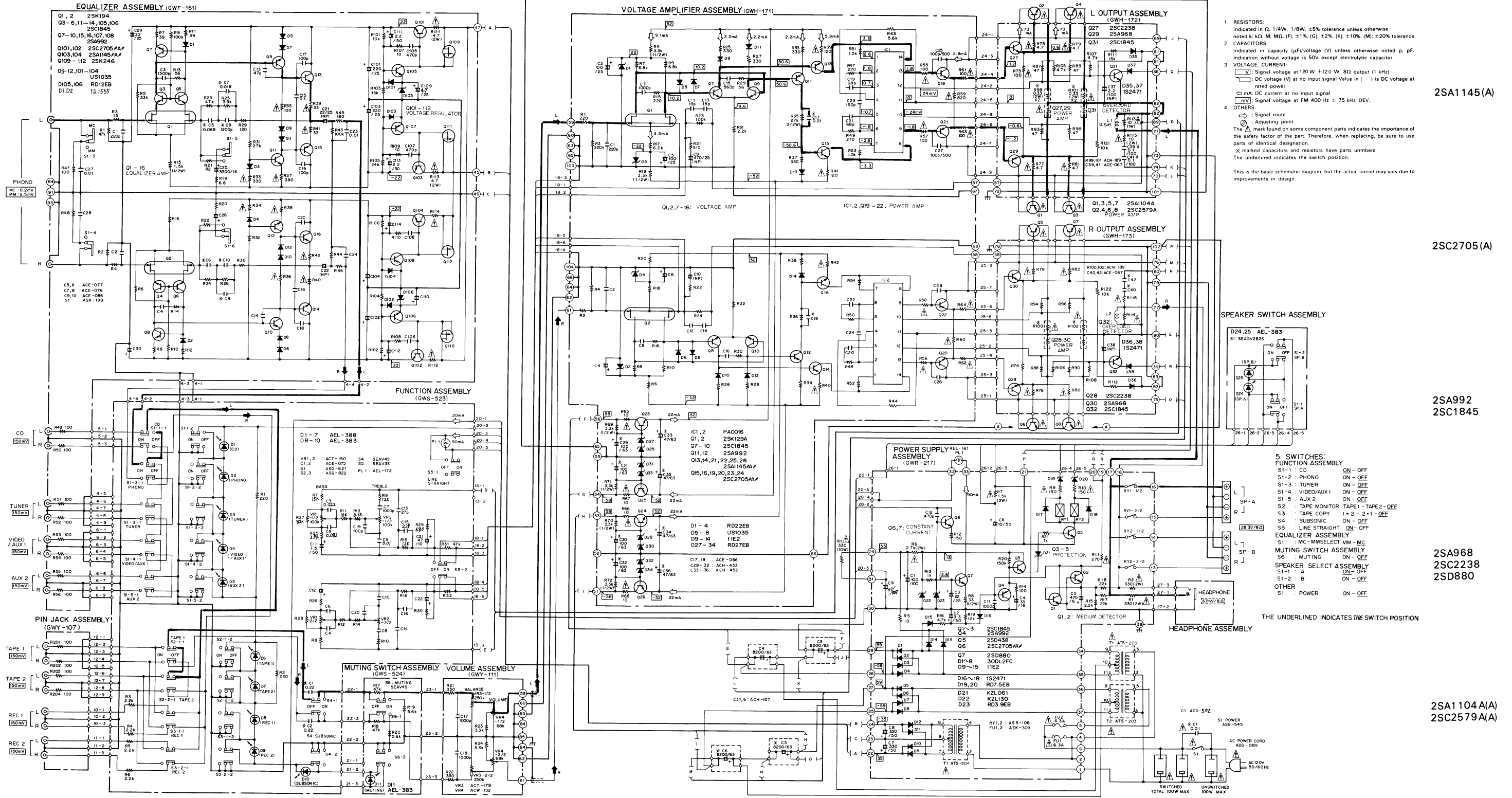

- RESISTORS:** Indicated in Ω, 1/4W, 1/8W, ±5% tolerance unless otherwise noted; k: kΩ, M: MΩ, (F): ±1%, (G): ±2%, (K): ±10%, (M): ±20% tolerance.
- CAPACITORS:** Indicated in capacity (μF)/voltage (V) unless otherwise noted; p: pF. Indication without voltage is 50V except electrolytic capacitor.
- VOLTAGE, CURRENT:**
 - ⊖: Signal voltage at 120 W + 120 W, 80 (output 1 kHz)
 - ⊖: DC voltage (V) at no input signal Value in () is DC voltage at rated power.
 - ⊖ mA: DC current at no input signal
 - mV: Signal voltage at FM 400 Hz ± 75 kHz DEV.
- OTHERS:**
 - ⊖: Adjusting point.
 - ⊖: The ⊖ mark found on some component parts indicates the importance of the safety factor of the part. Therefore, when replacing, be sure to use parts of identical designation.
 - ⊖: Marked capacitors and resistors have part numbers.
 - ⊖: The underlined indicates the switch position.

- SWITCHES:**
 - FUNCTION ASSEMBLY:**
 - S1-1: CD ON - OFF
 - S1-2: PHONO ON - OFF
 - S1-3: TUNER ON - OFF
 - S1-4: VIDEO/AUX1 ON - OFF
 - S1-5: AUX2 ON - OFF
 - S2: TAPE MONITOR TAPE1 - TAPE2 - OFF
 - S3: TAPE COPY 1 - 2 - 1 - OFF
 - S4: SUBSONIC ON - OFF
 - S5: LINE STRAIGHT ON - OFF
 - EQUALIZER ASSEMBLY:**
 - S1: MC-MMSELECT MM - MC
 - MUTING SWITCH ASSEMBLY:**
 - S6: MUTING ON - OFF
 - SPEAKER SELECT ASSEMBLY:**
 - S1-1: A ON - OFF
 - S1-2: B ON - OFF
 - OTHER: S1: POWER ON - OFF
- THE UNDERLINED INDICATES THE SWITCH POSITION

2SA1145(A)

2SC2705(A)

2SA992
2SC1845

2SA968
2SC2238
2SD880

2SA1104(A)
2SC2579(A)



Type No

Type No

Type No

Type No

hFE

Type No

Lot No

NOTE:
 The indicated semiconductors are representative ones only.
 Other alternative semiconductors may be used and are listed in the parts list.

External Appearance of Transistors and ICs

PA0016

2SD438

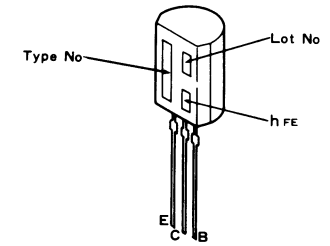

A

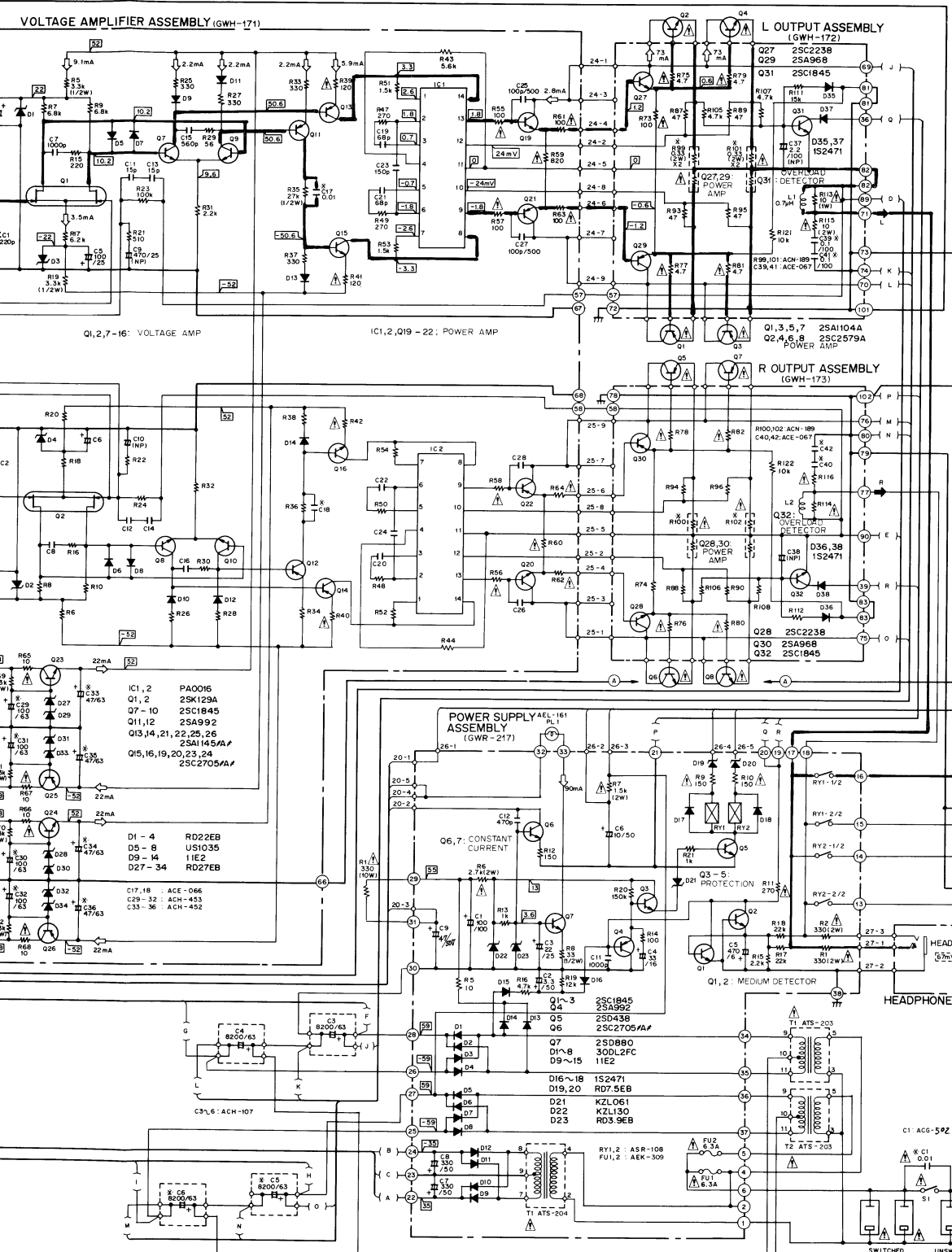

1. RESISTORS:
Indicated in Ω, 1/4W, 1/8W, ±5% tolerance unless otherwise noted. K: 1K, M: 1M, (F): ±1%, (G): ±2%, (K): ±10%, (M): ±20% tolerance
2. CAPACITORS:
Indicated in capacity (μF)/voltage (V) unless otherwise noted. p: pF. Indication without voltage is 50V except electrolytic capacitor.
3. VOLTAGE, CURRENT:
V: Signal voltage at 120 W +120 W, 8Ω output (1 kHz)
DC voltage (V) at no input signal Value in () is DC voltage at rated power.
mA: DC current at no input signal
mV: Signal voltage at FM 400 Hz ± 75 kHz DEV.
4. OTHERS:
→: Signal route
⊙: Adjusting point
The Δ mark found on some component parts indicates the importance of the safety factor of the part. Therefore, when replacing, be sure to use parts of identical designation.
X marked capacitors and resistors have parts numbers. The underlined indicates the switch position.

This is the basic schematic diagram, but the actual circuit may vary due to improvements in design.

SPEAKER SWITCH ASSEMBLY

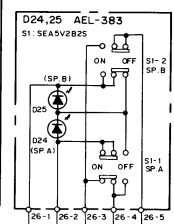

5. SWITCHES:
FUNCTION ASSEMBLY
S1-1: CD ON - OFF
S1-2: PHONO ON - OFF
S1-3: TUNER ON - OFF
S1-4: VIDEO/AUX1 ON - OFF
S1-5: AUX2 ON - OFF
S2: TAPE MONITOR TAPE1 - TAPE2 - OFF
S3: TAPE COPY 1-2-2-1 - OFF
S4: SUBSONIC ON - OFF
S5: LINE STRAIGHT ON - OFF
EQUALIZER ASSEMBLY
S1: MC-MMSELECT MM-MC
MUTING SWITCH ASSEMBLY
S6: MUTING ON - OFF
SPEAKER SELECT ASSEMBLY
S1-1: A ON - OFF
S1-2: B ON - OFF
OTHER
S1: POWER ON - OFF

THE UNDERLINED INDICATES THE SWITCH POSITION

2SA1145(A)

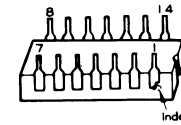

2SK246

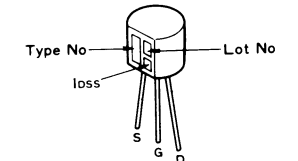

2SC2705(A)

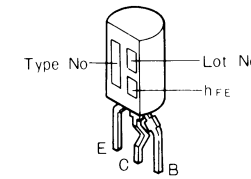

2SK194

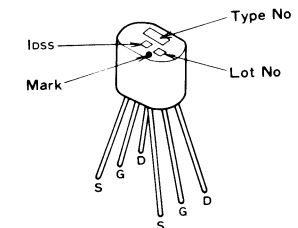

B

2SA992
2SC1845

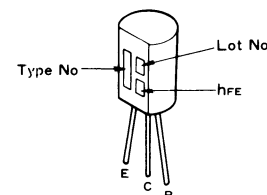

2SK129A

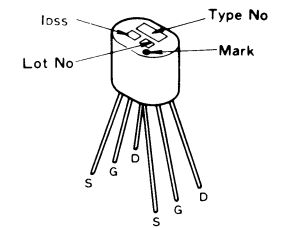

C

2SA968
2SC2238
2SD880

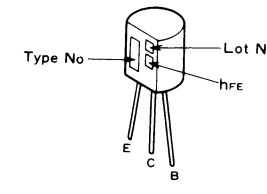

2SA1104(A)
2SC2579(A)

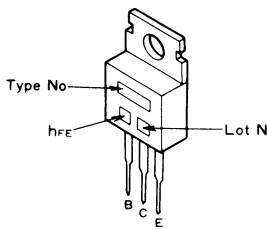

D

9. ELECTRICAL PARTS LIST

NOTES:









- When ordering resistors, first convert resistance values into code form as shown in the following examples.
Ex. 1 When there are 2 effective digits (any digit apart from 0), such as 560 ohm and 47k ohm (tolerance is shown by J = 5%, and K = 10%).
 560Ω 56 × 10¹ 561 RD¼PS 561J
 47kΩ 47 × 10³ 473 RD¼PS 473J
 0.5Ω 0R5 RN2H 0R5K
 1Ω 010 RS1P 010K
Ex. 2 When there are 3 effective digits (such as in high precision metal film resistors).
 5.62kΩ 562 × 10¹ 5621 RN¼SR 5621F
- The  mark found on some component parts indicates the importance of the safety factor of the part. Therefore, when replacing, be sure to use parts of identical designation.
- For your Parts Stock Control, the fast moving items are indicated with the marks **★★** and **★**.
★★ *GENERALLY MOVES FASTER THAN ★*.
This classification shall be adjusted by each distributor because it depends on model number, temperature, humidity, etc.

Miscellaneous Parts

P.C. BOARD ASSEMBLIES

Mark	Symbol & Description	Part No.
	Voltage amplification assembly	GWH-171
	Output (L) assembly	GWH-172
	Output (R) assembly	GWH-173
	Equalizer assembly	GWF-161
	Pin jack assembly	GWY-107
	Function switch assembly	GWS-523
	Muting switch assembly	GWS-524
	Volume assembly	GWY-111
	Power supply assembly	GWR-217
	Speaker switch assembly	
	Headphone assembly	

OTHERS

Mark	Symbol & Description	Part No.
 ★★	Q1, Q3, Q5, Q7	2SA1104A(A)-O/P/Y*
 ★★	Q2, Q4, Q6, Q8	2SC2579A(A)-O/P/Y*
 ★	C1 (0.01/AC250V)	ACG-502
	C3-C5 (8200/63V)	ACH-107
 ★	T1, T2 Power transformer	ATS-203
	*hfe of Q1-Q8 should have the same value.	
	Terminal 4P (SPEAKER)	AKE-110
 ★★	AC socket 3P	AKP-504
 ★★	Push switch (POWER)	ASG-545
★★	Remote slide rotary switch (PHONO)	ASX-207
 ★★	FU1, FU2 Fuse (6.3A)	AEK-309
★★	PL1 Pilot lamp	AEL-161
 ★	AC Power cord	ADG-089

Function Switch Assembly (GWS-523)

SEMICONDUCTORS

Mark	Symbol & Description	Part No.
★	D1-D7 (LED)	AEL-388
★	D8-D11 (LED)	AEL-383

SWITCHES

Mark	Symbol & Description	Part No.
★★	S1 Push switch (CD, PHONO, TU, VIDEO/AUX1, AUX2)	ASG-821
★★	S2, S3 Push switch (TAPE1, TAPE2)	ASG-822
★★	S4 Push switch (SUBSONIC)	SEAV4S
★★	S5 Push switch (LINE STRAIGHT)	SEAV3S

CAPACITORS

Mark	Symbol & Description	Part No.
	C1, C2 (0.22/100V)	ACE-075
	C15, C16	CCDSL 220J 50
	C19, C20	CCDSL 101J 50
	C13, C14	CCDSL 270J 50
	C11, C12	CEA 1R5M 50L
	C21, C22	CEA 470M 10L
	C7, C8	CQMA 102K 50
	C5, C6	CQMA 823K 50
	C3, C4	CQMA 223K 50
	C9, C10	CQMA 103K 50

RESISTORS

Note: When ordering resistors, convert the resistance value into code form, and then rewrite the part no. as before.

Mark	Symbol & Description	Part No.
★	VR1, VR2 Variable resistor (100k) R1-R16, R25-R32	ACT-190 RD1/4PM □□□J

OTHERS

Mark	Symbol & Description	Part No.
★★	PL1 Pilot lamp	AEL-175

Muting Switch Assembly (GWS-524)

SEMICONDUCTOR

Mark	Symbol & Description	Part No.
★	D11 (LED)	AEL-383

SWITCH

Mark	Symbol & Description	Part No.
★★	S6 (MUTING)	SEAV4S

RESISTORS

Note: When ordering resistors, convert the resistance value into code form, and then rewrite the part no. as before.

Mark	Symbol & Description	Part No.
	R17-R20	RD1/4PM □□□J

Volume Assembly (GWY-111)

CAPACITORS

Mark	Symbol & Description	Part No.
	C17, C18	CQSA 102J 50

RESISTORS

Note: When ordering resistors, convert the resistance value into code form, and then rewrite the part no. as before.

Mark	Symbol & Description	Part No.
★	VR3 Variable resistor (250k)	ACT-179
★	VR4 Variable resistor (68k)	ACW-132
	R21-R24	RD1/4PM □□□J

Voltage Amplification Assembly (GWH-171)

SEMICONDUCTORS

Mark	Symbol & Description	Part No.
★★	IC1, IC2	PA0016

Mark	Symbol & Description	Part No.
★★	Q13, Q14, Q21, Q22, Q25, Q26	2SA1145 (A)
★★	Q11, Q12	2SA992
★★	Q7-Q10	2SC1845
★★	Q15, Q16, Q19, Q20, Q23, Q24	2SC2705 (A)
★★	Q1, Q2	2SK129A
★	D1-D4	RD22EB
★	D5-D8	US1035
★	D9-D14	11E2
★	D27-D34	RD27EB

CAPACITORS

Mark	Symbol & Description	Part No.
	C17, C18 (0.01/100V)	ACE-066
	C33-C36 (47/63V)	ACH-452
	C29-C32 (100/63V)	ACH-453
	C25-C28	CCDSL 101K 500
	C23, C24	CCDSL 151J 50
	C19-C22	CCDSL 680J 50
	C3-C6	CEA 101M 25L
	C9, C10	CEX ANP 471M 25
	C7, C8	CKDYB 102K 50
	C15, C16	CKDYB 561K 50
	C11-C14	CMA 150J 500
	C1, C2	CQSXA 221J 160

RESISTORS

Note: When ordering resistors, convert the resistance value into code form, and then rewrite the part no. as before.

Mark	Symbol & Description	Part No.
	R21-R24	RDH1/4P □□□J
	R5, R6, R19, R20, R35, R36, R69, R70-R72	RD1/2PM □□□J
	R55-R58, R61-R68, R39-R42	RFA1/4PS □□□J
	Others resistor	RD1/4PM □□□J

Output (L) Assembly (GWH-172)

SEMICONDUCTORS

Mark	Symbol & Description	Part No.
★★	Q27	2SC2238
★★	Q29	2SA968
★★	Q31	2SC1845
★	D35, D37	1S2471

COIL

Mark	Symbol & Description	Part No.
	L1 AF choke coil (0.7μH)	ATH-054

CAPACITORS

Mark	Symbol & Description	Part No.
	C39, C41 (0.1/100V)	ACE-067
	C37	CEANP 2R2M 100

RESISTORS

Note : When ordering resistors, convert the resistance value into code form, and then rewrite the part no. as before.

Mark	Symbol & Description	Part No.
⚠	R99, R101 (0.33 Ω2W)	ACN-189
⚠	R87, R89, R93, R95, R105, R107	RD1/4PMF □□□J
	R111	RD1/4PM □□□J
⚠	R73	RFA1/4PS 101J
⚠	R113	RS1LMF 100J
⚠	R115	RS2LMF 100J
⚠	R75, R77, R79, R81	RFA1/4PS 4R7J

OTHERS

Mark	Symbol & Description	Part No.
	Screw	PBZ30P060FMC

Output (R) Assembly (GWH-173)

SEMICONDUCTORS

Mark	Symbol & Description	Part No.
★★	Q28	2SC2238
★★	Q30	2SA968
★★	Q32	2SC1845
★★	Q36, Q38	1S2471

COIL

Mark	Symbol & Description	Part No.
	L2 AF choke coil (0.7μH)	ATH-054

CAPACITORS

Mark	Symbol & Description	Part No.
	C40, C42 (0.1/100V)	ACE-067
	C38	CEAN2P2M100

RESISTORS

Note : When ordering resistors, convert the resistance value into code form, and then rewrite the part no. as before.

Mark	Symbol & Description	Part No.
⚠	R100, R102 (0.33/2W)	ACN-189
⚠	R88, R90, R94, R96, R106, R108,	RD1/4PMF □□□J
	R112	RD1/4PM □□□J
⚠	R114	RS1LMF 100J
⚠	R116	RS2LMF 100J
⚠	R74	RFA1/4PS 101J
⚠	R76, R78, R80, R82	RFA1/4PS 4R7J

OTHERS

Mark	Symbol & Description	Part No.
	Screw	PBZ30P 060FMC

Power Supply Assembly (GWR-217)

SEMICONDUCTORS

Mark	Symbol & Description	Part No.
★★	Q1-Q3	2SC1845
★★	Q4	2SA992
★★	Q5	2SD438
★★	Q6	2SC2705
★★	Q7	2SD880
★	D1-D8	30DL2FC
★	D9-D15	11E2
★	D16-D18	1S2471
★	D19-D20	RD75EB
★	D21	KZL061
★	D26	RD39EB
★	D22	KZL130
★	D23	RD3.9EB

TRANSFORMER

Mark	Symbol & Description	Part No.
⚠ ★	T1 Power transformer	ATS-204

RELAY

Mark	Symbol & Description	Part No.
★★	RY1, RY2 Relay	ASR-108

CAPACITORS

Mark	Symbol & Description	Part No.
	C6	CEA 100M 50L
	C1	CEA 101M 100L
	C3	CEA 220M 25L
	C2	CEA 3R3M 50L
	C4	CEA 330M 16L
	C7, C8	CEA 331M 50L
	C5	CEA 471M 6L
	C11	CKDYB 102K 50
	C12	CKDYB 471K 50
	C9	CEA 470M 50L

RESISTORS

Note: When ordering resistors, convert the resistance value into code form, and then rewrite the part no. as before.

Mark	Symbol & Description	Part No.
	R8	RD1/2PM 330J
	R12-R21	RD1/4PM □□□J
△	R9-R11	RFA1/4PS □□□J
△	R1, R2, R6, R7	RS2LMF □□□J
△	R5	RFA1/4PS 100J

OTHERS

Mark	Symbol & Description	Part No.
	Screw	PBZ30P060FMC

Speaker Switch Assembly

SEMICONDUCTORS

Mark	Symbol & Description	Part No.
★	D25, D24 (SP. A, B)	AEL-383

SWITCH

Mark	Symbol & Description	Part No.
★★	S1 Push switch (SPEAKERS)	SEA5V2B2S

Headphone Assembly

OTHERS

Mark	Symbol & Description	Part No.
	Jack (PHONES)	AKN-945

Equalizer Assembly (GWF-161)

SEMICONDUCTORS

Mark	Symbol & Description	Part No.
★★	Q103, Q104	2SA1145 (A)
★★	Q7-Q10, Q15, Q16, Q107, Q108	2SA992
★★	Q3-Q6, Q11-Q14, Q105, Q106	2SC1845
★★	Q101, Q102	2SC2705
★★	Q1, Q2	2SK194
★★	Q109, Q109-Q112	2SK246
★	D105, D106	RD12EB
	D3-D12, D101-D104	US1035
	D1, D2	US1555

SWITCH

Mark	Symbol & Description	Part No.
★★	S1 Remote slide switch (MC-MM)	ASX-199

CAPACITORS

Mark	Symbol & Description	Part No.
	C7, C8 (0.018/100)	ACE-076
	C5, C6 (0.068/100)	ACE-077
	C9, C10 (1200p/100)	ACE-086
	C17-C20	CCDSL 101K 500
	C111-C114	CEA 2R2M 50L
	C29, C30	CEA 220M 25L
	C21, C22	CEXANP 220M 25
	C101-C104	CEYA 221M 25
	C25, C26	CEYA 332M 16
	C13, C14	CMA 470J 500
	C23, C24, C27, C28	CQMA 103J 50
	C15, C16	CQMA 104J 50
	C3, C4	CQMA 152J 50
	C1, C2	CQSA 221J 50
	C105-C108	CQSA 471J 50
	C109, C110	CEYA 470M 25L

RESISTORS

Note: When ordering resistors, convert the resistance value into code form, and then rewrite the part no. as before.

Mark	Symbol & Description	Part No.
	R29, R30, R21, R22	RDH1/4P □□□J
	R23-R26	RDH1/4P □□□J
	R19, R20	RDH1/4P 6R8J
	R15, R16	RD1/2PM 152J
	R33-R42	RFA1/4PS □□□J
	R49, R50	RD1/2PM □□□J
	R111-R114	RS2LMF 4R7J
	Others resistor	RD1/4PM □□□J

OTHERS

Mark	Symbol & Description	Part No.
	Terminal 4P (VIDEO SOUND/AUX1, AUX2)	AKB-115
	Terminal 6P (PHONO, CD, TU)	AKB-117

Pin Jack Assembly (GWY-107)

RESISTORS

Note: When ordering resistors, convert the resistance value into code form, and then rewrite the part no. as before.

Mark	Symbol & Description	Part No.
	R201-R204	RD1/4PM 101J

OTHERS

Mark	Symbol & Description	Part No.
	Terminal 4P (TAPE1, TAPE2)	AKB-116

10. SAFETY INFORMATION

1. SAFETY PRECAUTIONS

The following check should be performed for the continued protection of the customer and service technician.

LEAKAGE CURRENT CHECK

Measure leakage current to a known earth ground (water pipe, conduit, etc.) by connecting a leakage current tester such as Simpson Model 229-2 or equivalent between the earth ground and all exposed metal parts of the appliance (input/output terminals, screwheads, metal overlays, control shaft, etc.). Plug the AC line cord of the appliance directly into a 120V AC 60Hz outlet and turn the AC power switch on. Any current measured must not exceed 0.5mA.

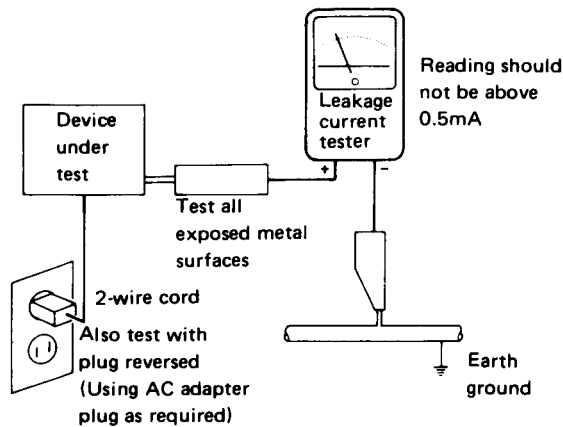

AC Leakage Test

ANY MEASUREMENTS NOT WITHIN THE LIMITS OUTLINED ABOVE ARE INDICATIVE OF A POTENTIAL SHOCK HAZARD AND MUST BE CORRECTED BEFORE RETURNING THE APPLIANCE TO THE CUSTOMER.

2. PRODUCT SAFETY NOTICE

Many electrical and mechanical parts in the appliance have special safety related characteristics. These are often not evident from visual inspection nor the protection afforded by them necessarily can be obtained by using replacement components rated for voltage, wattage, etc. Replacement parts which have these special safety characteristics are identified in this Service Manual.

Electrical components having such features are identified by marking with a Δ on the schematics and on the parts list in this Service Manual.

The use of a substitute replacement component which does not have the same safety characteristics as the PIONEER recommended replacement one, shown in the parts list in this Service Manual, may create shock, fire, or other hazards.

Product Safety is continuously under review and new instructions are issued from time to time. For the latest information, always consult the current PIONEER Service Manual. A subscription to, or additional copies of, PIONEER Service Manual may be obtained at a nominal charge from PIONEER.