

SERVICE
MANUAL 4220

marantz

model 4220

Stereo 2 + Quadradial 4 Receiver

This Service Manual should be apply to Serial NO. 5001 (U.S.A.), 51601 (EUROPE), 60001 (CANADA) and above.

TABLE OF CONTENTS

SECTION	PAGE
Introduction	1
Service Notes	1
AM Tuner	1
FM Tuner	1
Phono and Pre-Amplifier	3
Main Amplifier	3
BTL (Balanced Transformerless) Connection	3
Power Supply Unit	3
Audio Trouble Analysis	3
Test Equipment Required for Servicing	4
AM Alignment Procedure	5
FM Alignment Procedure	5
Audio Adjustment	6
Parts List	15
Technical Specifications	24

LIST OF ILLUSTRATIONS

FIGURE	PAGE
1. Dial Stringing	6
2. Front Panel Adjustment and Component Locations	7
3. Main Chassis Component Locations (Top View)	7
4. Rear Panel Adjustment and Component Locations	8
5. Main Chassis Component Locations (Bottom View)	8
6. FM and AM Tuner Assembly P100 Component Locations	9
7. Tone Amplifier and Loudness Assembly P400 Component Locations	9
8. Phono Amplifier Assembly P200 Component Locations	9
9. SQ Decoder Assembly P300 Component Locations	9
10. Power Amplifier Assembly P700 Component Locations	10
11. Power Supply Unit Assembly P800 Component Locations	10
12. Balance Control Unit Assembly PG01 Component Locations	10
13. Indicator Lamps Assembly PY01 Component Locations	10
14. Schematic Diagram	11, 12
15. Exploded Mechanical Diagram	13, 14

TABLE	PAGE
1. Test Equipment Required for Servicing	4

marantz®

SERVICE BULLETIN

SS-MAR0234

model number
4220

for serial numbers
ALL

bulletin number

M-4220-2

subject

SERVICE MANUAL CORRECTION

engineering approval

D. N. Almeida 7-14-76

date

5/20/76

This Service Bulletin corrects an schematic error on page 12 of the Marantz Model 4220 Service Manual.

INCORRECT

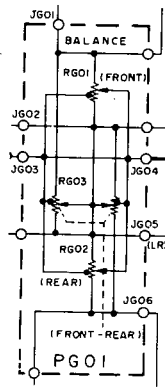

CORRECTED

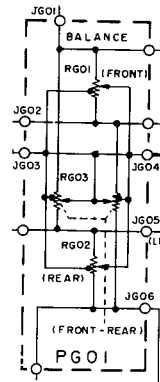

Incorporate this change into your Service Manual to ensure proper reference information.

Almeida

Albert Almeida, Manager
Technical Services

INTRODUCTION

This service manual was prepared for use by Authorized Warranty Stations and contains service information for Marantz Model 4220 Stereo 2+ Quadradial 4 Receiver.

Servicing information and voltage data included in this manual are intended for use by the knowledgeable and experienced technician only. All instruction should be read carefully. No attempt should be made to proceed without a good understanding of the operation in the receiver. The parts list furnish information by which replacement part may be ordered from the Marantz Company. A simple description is included for parts which can be usually be obtained through local suppliers.

1. SERVICE NOTES

As can be seen from the circuit diagram, the chassis of Model 4220 consists of following units. Each unit mounted on a printed circuit board is described within the square enclosed by a bold dotted line on the circuit diagram.

- | | |
|--------------------------------------|-----------------------------|
| 1. FM and AM Tuner | mounted on P.W. Board, P100 |
| 2. Tone Amplifier and Loudness | mounted on P.W. Board, P400 |
| 3. Phono Amplifier | mounted on P.W. Board, P200 |
| 4. SQ Decoder | mounted on P.W. Board, P300 |
| 5. Power Amplifier | mounted on P.W. Board, P700 |
| 6. Power Supply Unit | mounted on P.W. Board, P800 |
| 7. Balance Control Unit | mounted on P.W. Board, PG01 |
| 8. Indicator Lamps | mounted on P.W. Board, PY01 |

2. AM TUNER

All components except ferrite bar antenna are mounted on a printed circuit board P100.

The AM signals induced in a ferrite bar antenna are applied to the base of converter transistor H113 through a capacitor of C171, while the local oscillator voltage is injected to the emitter of H113 through a capacitor C172. Both AM signals and oscillating voltage are mixed at the base-emitter junction and converted into 455KHz intermediate frequency. The resulting IF signal is applied to the first IF transformer L116 consisting of one ceramic filter and two tuned circuits.

The output of L116 is led to the transistor H104 which in turn apply its output to the transistor of next stage H105. The fully amplified IF output is then applied to the diode H123 to detect audible signal through the detector transformer L117. The detected audio signal is filtered and the final audio output is obtained from pin terminal J118 and applied to the audio amplifier section through the selector switch.

The DC component of the detected IF signal is used as a AGC voltage to control emitter current of H104 through the resistor R185. A part of IF signal output is also applied to the diode H124 through a capacitor C180 and rectified to obtain DC current for energizing the signal strength meter M002.

2.1 Suggestions for AM Tuner Trouble Shooting

Check for broken AM bar antenna, next try to tune station by rotating fly-wheel tuning knob slowly and observe the signal strength meter whether it deflects or not. If the signal strength meter gives a deflection at several frequencies received, no failure may exist in the stages at least preceding final IF transformer L117. Next connect a oscilloscope to the pin terminal J118 and check for audio signals with the tuning meter deflected. If the signal strength meter does not deflect, check the local oscillator circuit. Normal oscillating voltage at the hot end of the oscillator tuning capacitor is about 2 or 3 volts, varying with tuning capacitor position. When measuring oscillating voltage use an RF VTVM, no circuit tester gives correct indication.

3. FM TUNER

All components are mounted on a printed circuit board P100.

FM signals induced by an FM antenna are led to FM antenna coil L101.

These signals are then applied to the FET RF amplifier which in turn applies its output to the next transistor mixer H102 through a high Q tuned circuit.

The mixer convert its input signal into 10.7MHz intermediate frequency and amplifies it at the same time. The H103 is a local oscillator and its output is injected into the base of mixer transistor, the injection voltage is about 40mV.

The 10.7 MHz front end output is led to the next IF section. The IF section consists of five stage of IF amplifier and one stage of sub IF amplifier. Two pieces of ceramic filters are also used to obtain high selectivity, a pair of symmetrical diode limiters are also employed for the best limiting characteristics, improved capture ratio and good AM suppression. A part of IF amplifier H105 output is rectified by the diode H115, H116 and its DC output is fed back to the gate of FET RF amplifier to decrease the gain with increased signal strength.

3.1 Muting and Auto-Stereo Switching Circuits

The muting circuit consisting of all solid-state electrical switching has been incorporated in the Model 4220.

The DC voltage obtained by rectifying the sub IF output signal from the H109 is applied to the base of H110 and turns on it, if the sub IF output is greater than predetermined level (muting threshold level).

When H110 turns on, the muting switch transistor H111 is turned on, thus decreasing the emitter collector resistance to near zero ohm and allowing emitter current path to the final IF amplifier H108.

When the input signal is lower than the predetermined level, the DC output obtained is small and can not turn on the H110, thus the H110 keeps its turn off state and this makes the switch transistor keep H111 turn off, then no emitter current is supplied to the H108 and signals below the threshold level are muted out.

The muting threshold level can be varied by adjusting the trimming resistor R153.

The DC voltage obtained is also used to make the Auto-Stereo switching transistor H112 turn on and off.

3.2 MPX Stereo Decoding Circuit

A Non-equalized audio signal from the FM detector is applied through the phase adjuster network of C148 and R161 to input terminal pin ① on the MPX decoder IC H114. The MPX decoder IC consists of a stereo decoder and postamplifier for the output. The right and left channel signals decoded by the stereo decoder H114, appear at pin ⑩ (right channel) and pin ⑪ (left channel), respectively. These signals are passed through the low-pass filters and de-emphasis networks to eliminate undesirable residual switching signals and are then delivered to postamplifier input pin ⑤ (right channel) and pin ⑦ (left channel), respectively. The signals amplified in the postamplifiers to the required level (approximately 10dB) are delivered to pin ⑥ (right channel) and pin ⑧ (left channel), and are then passed through C169 and C168 to pin terminals J114 and J115, hence, through the selector switch to the audio amplifier section. Pin ⑬ on the MPX IC H114 is connected through R163 to the collector of the autostereo switch transistor H112, which turns on or off according to the incoming FM signal strength, thereby automatically switching between the stereophonic and monaural operations. The H112 turns on or off in accordance with whether the FM signal strength is more or less than approximately $25\mu V$.

3.3 Suggestion for Trouble Shooting of FM Tuner

3.3.1 Symptom: No FM Reception

First turn on the power switch and try to tune FM stations. Rotate the fly-wheel tuning knob slowly and observe the FM TUNING meter. If the TUNING meter deflect at several frequencies received, the tuner circuits preceding the discriminator circuit may have no failure. When no reading is obtained in the meter, check FM local oscillator circuit, using an RF VTVM. The normal local oscillator voltage is one or two volts (rms) at the tuning capacitor, depending on the tuning capacitor position. When TUNING meter deflects but no sound is obtained, check audio circuits, using high sensitive oscilloscope.

3.3.2 Symptom: No Stereo Separation

Connect an FM RF signal generator output modulated by a stereo modulator to the rear FM

ANTENNA terminals, and check the stereo beacon is turned on or not. If not turned on, check for 19 KHz pilot signal and 38 KHz switching signal, using an oscilloscope.

4. PHONO AND PRE-AMPLIFIER

Signals from the PHONO jacks are applied to the phono-amplifier mounted on P200. The amplified and RIAA equalized phono signals and signals from the tuner section and the CD-4/AUX and TAPE MONITOR 2 IN jacks are applied to the selector switch which, in turn, leads the selected signals to the TAPE 1 MON switch and TAPE MONITOR 1 OUT jacks. Applied to the other section of the TAPE 1 MON switch are signals from the TAPE MONITOR 1 IN jacks. The TAPE 1 MON switch selects the signals from the selector switch or those from the TAPE MONITOR 1 IN jacks and the selected signals go to the mode switch. Signals are then mode processed by the mode switch and its associated circuit and applied to the tone control amplifier through the volume control. The bass and treble controlled signals from the tone control amplifier pass through the balance control section and they reach the main amplifier.

4.1 Mode Switch

Mode switch S002 has positions of MONO, 2 CH, DISCRETE, AMBIENCE, and SQ.

In the MONO position, all input signals are mixed together and delivered to all four channels.

In the 2 CH position, each pair of input signals right-front (RF) and right-rear (RR), and left-front (LF) and left-rear (LR) are mixed together. The resultant signals (RF + RR) and (LF + LR) are delivered to the pairs of RF and RR, and LF and LR channels, respectively.

In the DISCRETE position, each channel signal is separately routed to the corresponding channel.

In the AMBIENCE position, 2-channel stereo input signals are converted into quadraphonic signals through the SQ circuit.

In the SQ DECODER position, signal sources encoded by the CBS SQ system are ideally decoded into 4-channel signals.

4.2 Balance Control

Signals from the tone control amplifiers are fed into the balance control circuit, in which the signals are controlled by three balancers: FRONT L-R, REAR L-R, and FRONT-REAR. By setting the FRONT-REAR balancer to the "FRONT" side and the FRONT L-R balancer to the "L" side, for example, only the front left channel is driven.

Balance controlled signals are led to the main amplifier section for further power amplification.

5. MAIN AMPLIFIER

The power drive IC's H703, H704, H705, and H706 drive the power transistor pairs of H707 and H711, H708 and H712, H709 and H713, and H710 and H714, respectively. The H701 and H702 are inverter transistors for the BTL operation.

6. BTL (Balanced Transformerless) CONNECTION

This power amplifier is designed to operate in either 2-channel or 4-channel modes, depending on the setting of the POWER MODE switch that incorporates phase-conversion and power switch for BTL connection. With this switch placed in the 8W x 4 position, this unit operates as an 8W 4-channel amplifier. With the switch placed in the 20W x 2 position, the unit operates as a 20W 2-channel amplifier, in this case, the power output is obtained only from FRONT SPK Terminals.

7. POWER SUPPLY UNIT

The power supply unit consisting of transistors H801 and Zenner diode H803, which operates as an automatic voltage regulator provides +35V DC to all of the amplifiers except main amplifiers and +14V DC to the tuner section.

8. AUDIO TROUBLE ANALYSIS

1. Excessive line consumption
 - a. Check for shorted rectifiers H001.

- 2. No line consumption or zero bias.
 - a. Check line cord, fuse, shorted H703 through H706.
 - b. Check for open rectifiers H001, or open L001.
- 3. Excessive hum and noise level
 - a. Check filter capacitors C005, C006.
 - b. Check for shorted transistor H801.
- 4. Parasitic oscillation
 - a. Check for defective capacitors, C711~714, C727~730, C731~C734.

9. TEST EQUIPMENT REQUIRED FOR SERVICING

Table 1 lists the test equipment required for servicing the Model 4220 Receiver.

Item	Manufacturer and Model No.	Use
AM Signal Generator		Signal source for AM alignment.
Test Loop		Used with AM Signal generator.
FM Signal Generator	Less than 0.3% distortion	Signal source for FM alignment.
Stereo Modulator	Less than 0.3% distortion	Stereo separation alignment and trouble shooting.
Audio Oscillator	Weston Model CVO-100P, less than 0.02% residual distortion is required.	Sinewave and squarewave signal source.
Oscilloscope	High sensitivity with DC horizontal and vertical amplifiers.	Waveform analysis and trouble shooting and ASO alignment.
VTVM	With AC, DC, RF range	Voltage measurements.
Circuit Tester		Trouble shooting.
AC Wattmeter	Simpson, Model 390	Monitors primary power to Amplifier.
AC Ammeter	Commercial Grade (1-10A)	Monitors amplifier output under short circuit condition.
Line Voltmeter	Commercial Grade (0-150VAC)	Monitors potential of primary power to amplifier.
Variable Autotransformer (0-140VAC, 10 amps)	Powerstat, Model 116B	Adjusts level of primary power to amplifier.
Shorting Plug	Use phono plug with 600 ohm across center pin and shell.	Shorts amplifier input to eliminate noise pickup.
Output Load (8 ohms, 0.5% 100W)	Commercial Grade	Provides 8-ohm load for amplifier output termination.
Output Load (4 ohms, 0.5% 100W)	Commercial Grade	Provides 4-ohm load for amplifier output termination.

Table 1 Test Equipment Required for Servicing

10. AM ALIGNMENT PROCEDURE

10.1 AM IF Alignment

1. Connect a sweep generator to J107 and an alignment scope to the test point ③.
2. Rotate each core of IF transformer L116 and L117 for maximum height and flat top symmetrical response.

10.2 AM Frequency Range and Tracking Alignment

1. Set AM signal generator to 525 KHz. Turn the tuning capacitor fully closed (place the tuning pointer at the low end.) and adjust the oscillator coil L115 for maximum audio output.
2. Set the signal generator to 1650 KHz. Place the tuning pointer in the high frequency end and adjust the oscillator trimmer on the oscillator tuning capacitor (CA-2) for maximum audio output.
3. Repeat the step 1 and 2 until no further adjustment is necessary.
4. Set the generator to 600 KHz and tune the receiver to the same frequency and adjust a slug core of AM ferrite rod antenna for maximum output.
5. Set the generator to 1400 KHz and tune the receiver to the same frequency and adjust the trimming capacitors of antenna (CA-1) for maximum output.
6. Repeat the step 4 and 5 until no further adjustment is necessary.

Note: During tracking alignment reduce the signal generator output as necessary to avoid AGC action.

11. FM ALIGNMENT PROCEDURE

1. Connect an FM signal generator to the FM ANTENNA terminals and an oscilloscope and an audio distortion analyzer to the TAPE MONITOR OUT jacks on the rear panel.
2. Set the FM SG to 87.5 MHz and provide about 3 to 5 μ V. Place the tuning pointer at the low frequency end by rotating the tuning knob and adjust the core of oscillator coil L103 to obtain maximum audio output.
3. Set the FM SG to 108.5 MHz and provide about 3 to 5 μ V output. Rotate the tuning knob and place the tuning pointer at the high frequency end and adjust the trimming capacitor C187 for maximum output.
4. Repeat the step 2 and 3 until no further adjustment is necessary.
5. Set the FM SG to 90 MHz and tune the receiver to the same frequency. Decrease signal generator output until the audio output level decreases with the decreasing generator output. Adjust the antenna coil L101, RF coil L102 and IF transformer L105 for minimum audio distortion.
6. Set the FM SG to 106 MHz and tune the receiver to the same frequency. Adjust the trimming capacitor CF-1, CF-2 for minimum distortion.
7. Repeat the step 5 and 6 until no further adjustment is necessary.
8. Connect a DC VTVM with ± 0.5 volt range selected to the test point ④ (J120) and adjust the secondary core (upper) of discriminator transformer L107 so that no voltage reading is obtained on the VTVM at no signal.
Next set the FM SG to 98 MHz and increase the output level to 1 K μ V, then tune the receiver to the same frequency so that no deflection is obtained on the VTVM.
Adjust primary core (bottom) of L107 for minimum distortion, and adjust the L108 for the maximum reading on the VTVM connected to the J109.

11.1 Stereo Separation Alignment

1. Set the FM SG to provide 1 K μ V at 98 MHz.
Tune the receiver to the same frequency perfectly (so that the VTVM connected to the test point ④ gives no reading).
2. Modulate the FM SG with stereo composite signal consisting of subchannel signal only (of course a pilot signal must be included).
Adjust the core of L110 for maximum audio output, then, modulate the FM SG with a stereo composite signal consisting of L or R channel only, and adjust the trimming resistor R 161 for maximum and equal separation in both channels.

11.2 Muting Circuit Alignment

1. Set the FM SG output to provide $25\mu\text{V}$ (IHF) at 98 MHz and tune the receiver to the same frequency.

Adjust the trimming resistor R153 for the threshold level of $25\mu\text{V}$ (during this adjustment turn the MUTING pushswitch "on").

12. AUDIO ADJUSTMENT

Connect a VTVM to the SPEAKER jacks. Apply a 1 KHz, 150mV audio signal to the CD-4/AUX jacks. Then, adjust R719, R720, R721, and R722 so that the power output may be 8W (at 8 ohm load).

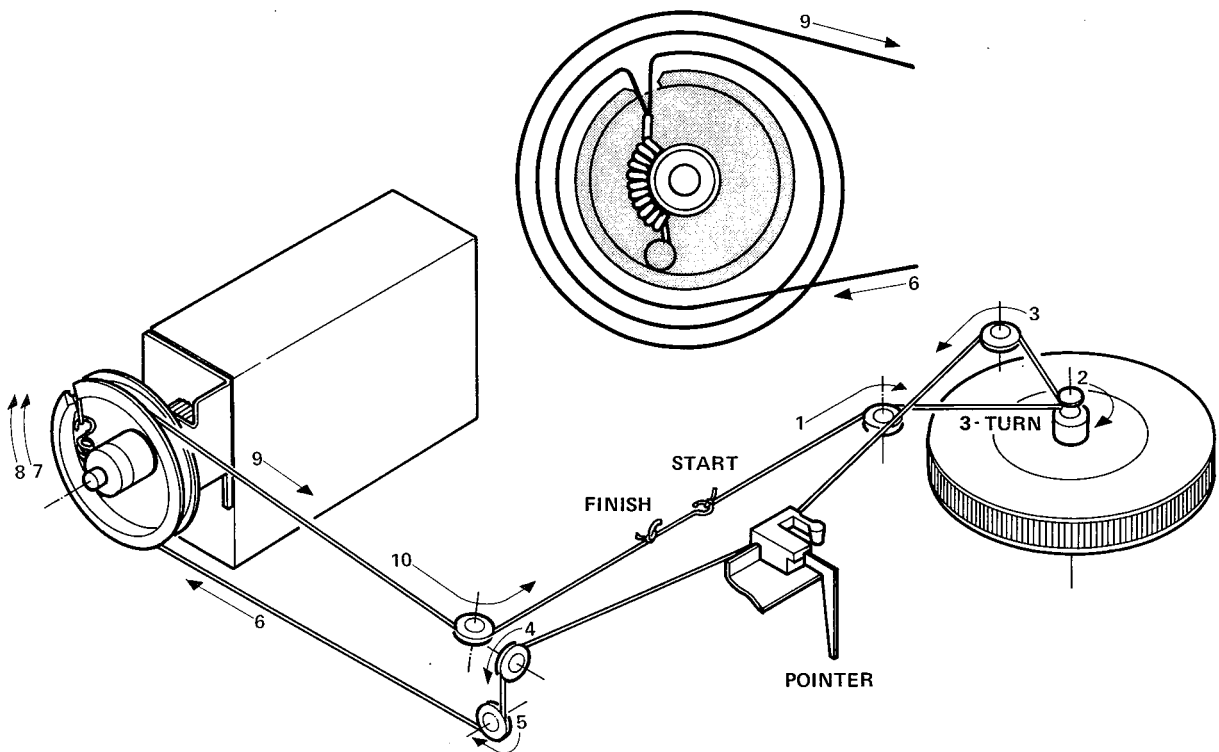

Figure 1. Dial Stringing

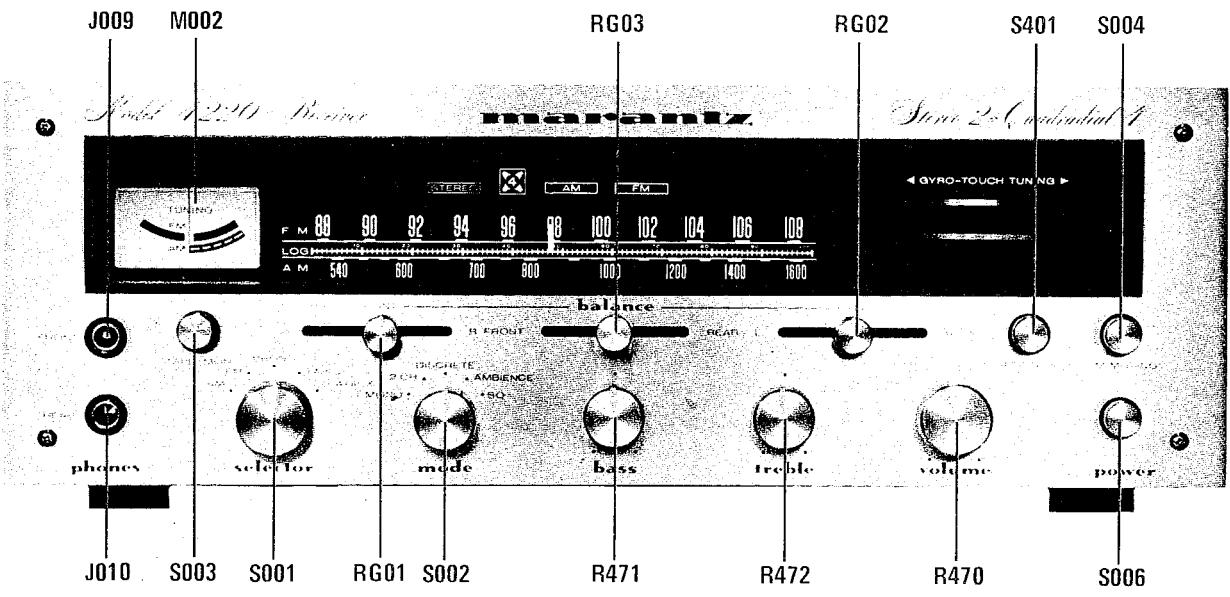

Figure 2. Front Panel Adjustment and Component Locations

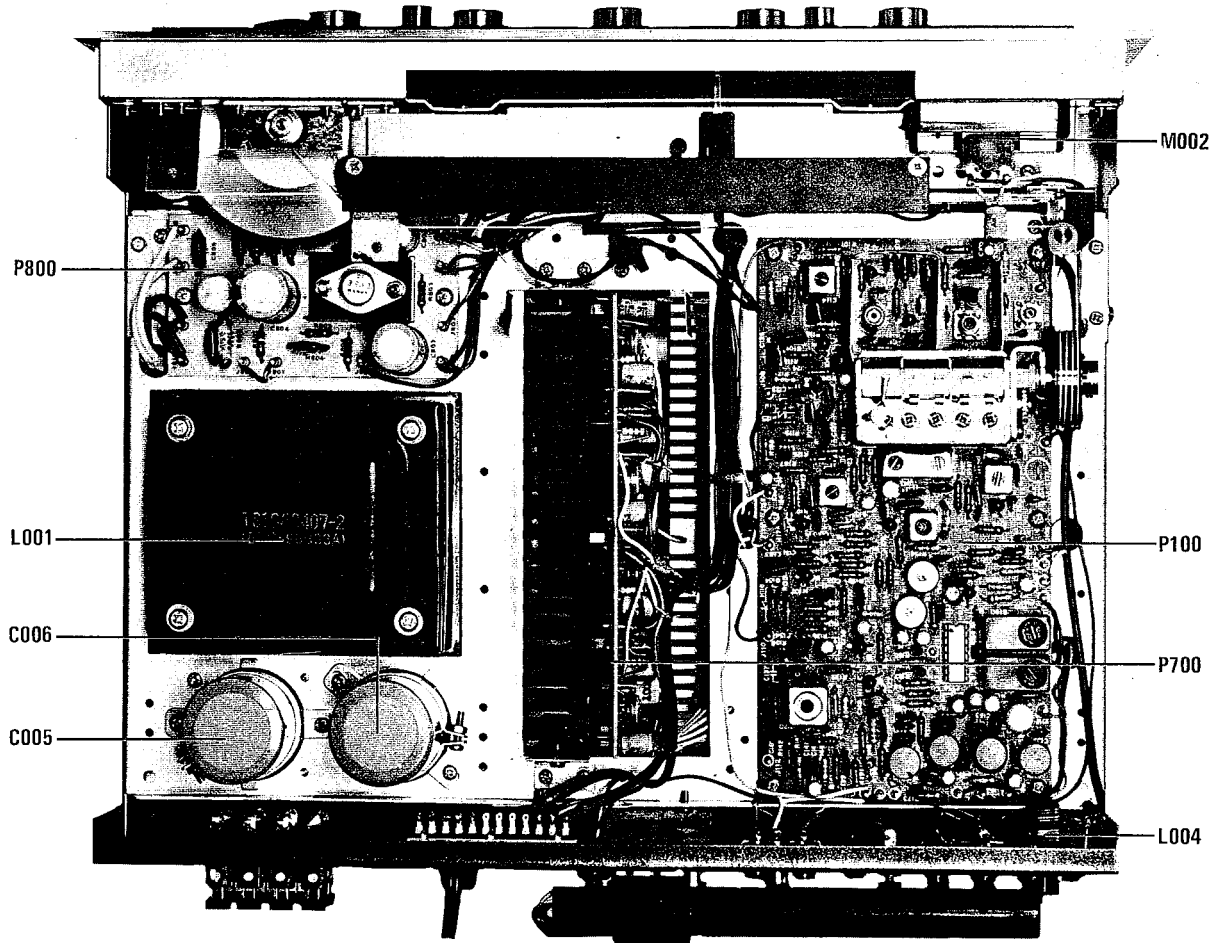

Figure 3. Main Chassis Component Locations (Top View)

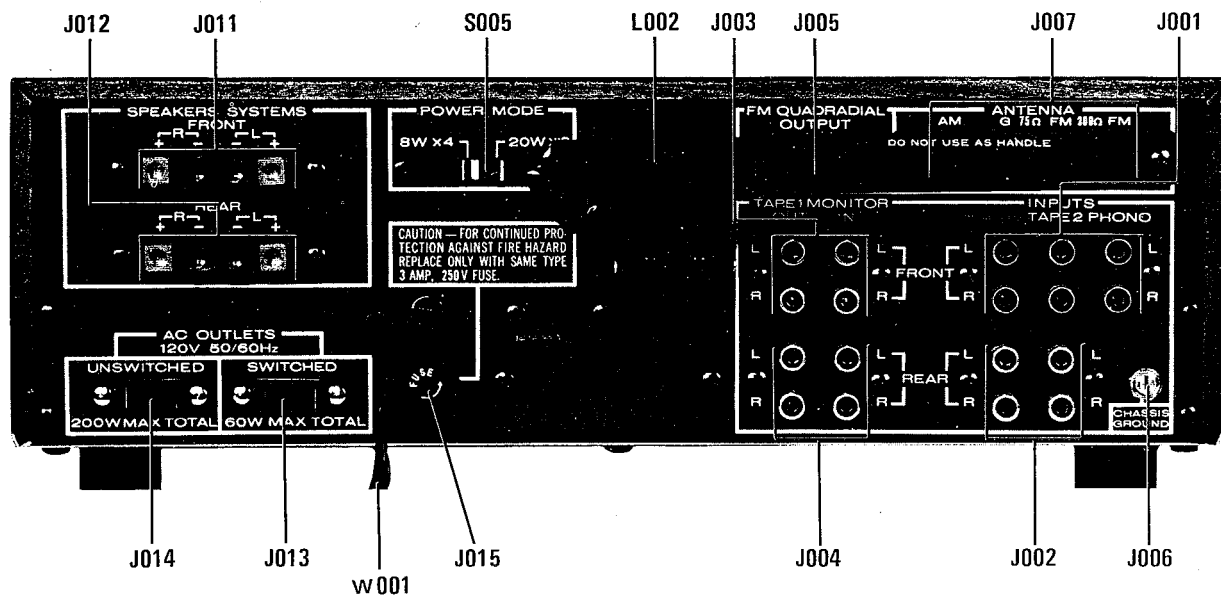

Figure 4. Rear Panel Adjustment and Component Locations

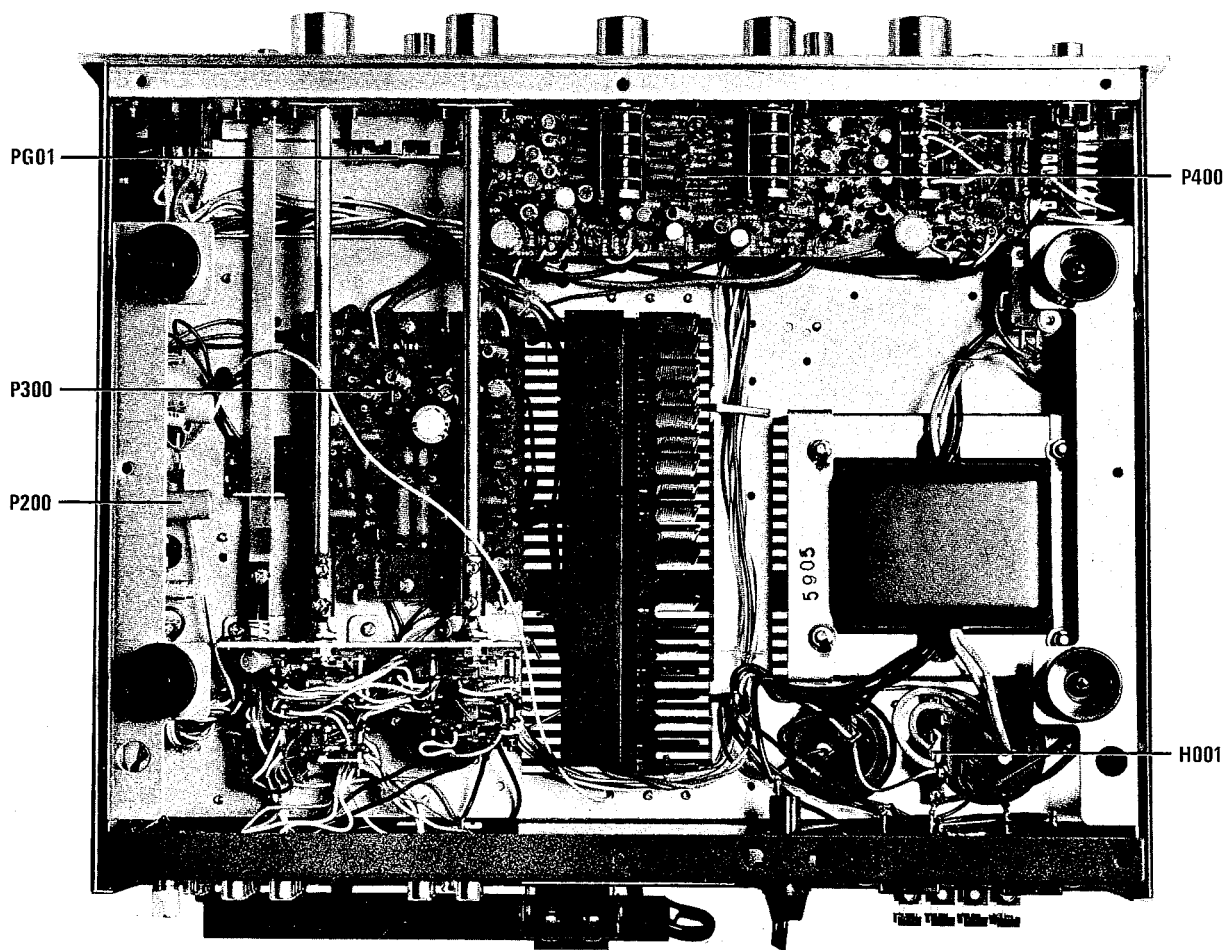

Figure 5. Main Chassis Component Locations (Bottom View)

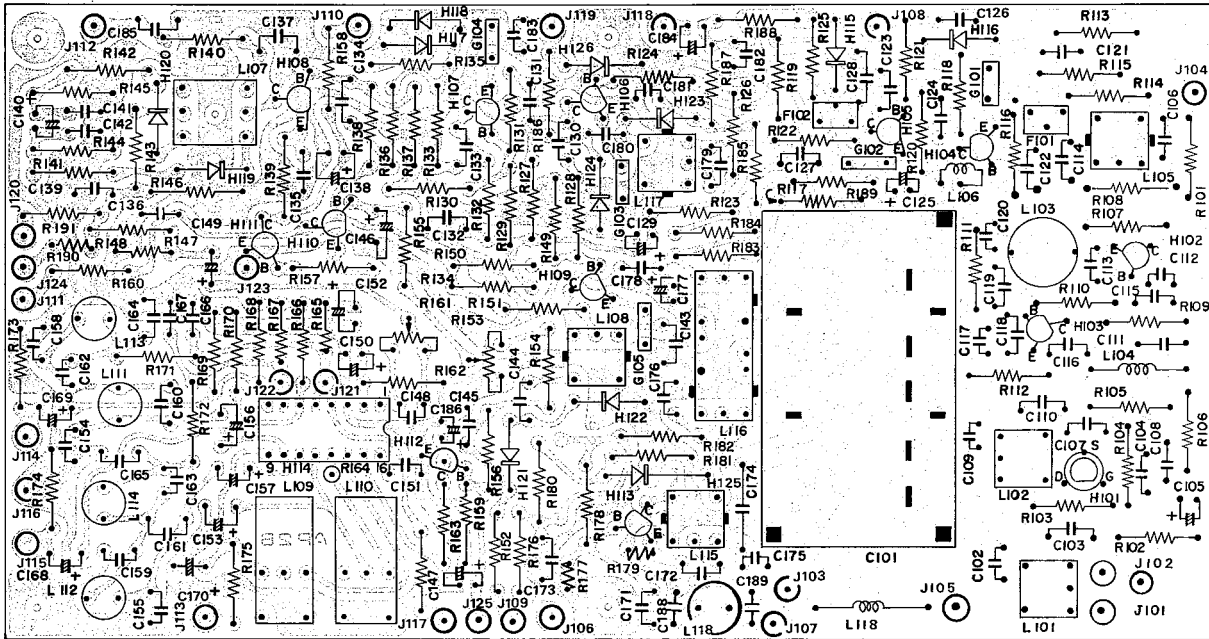

Figure 6. FM and AM Tuner Assembly P100 Component Locations

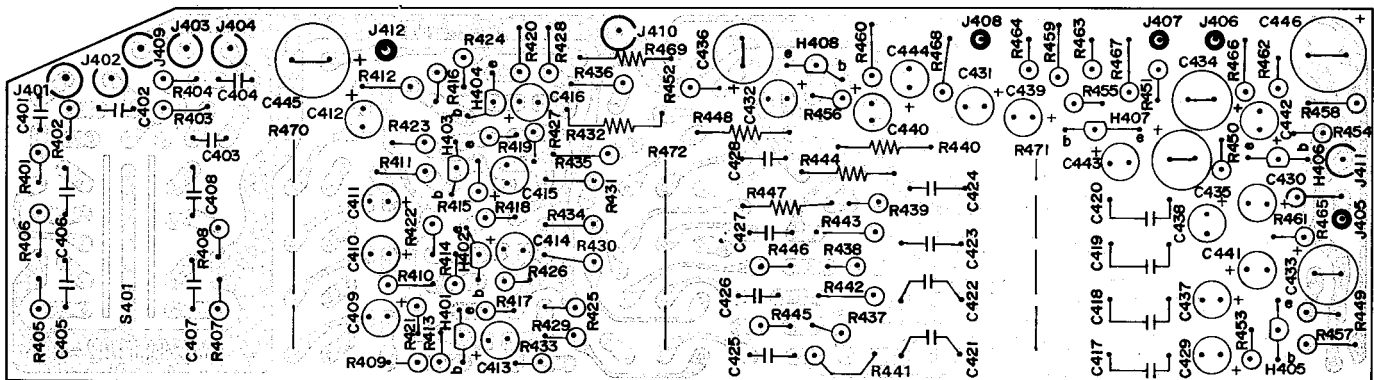

Figure 7. Tone Amplifier and Loudness Assembly P400 Component Locations

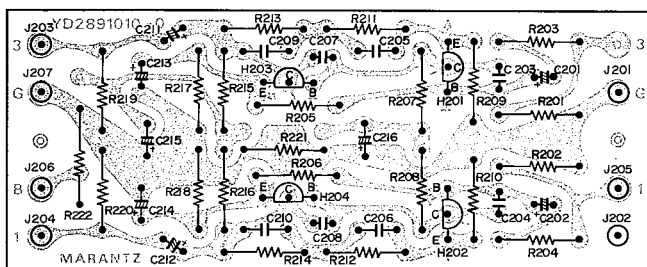

Figure 8. Phono Amplifier Assembly P200 Component Locations

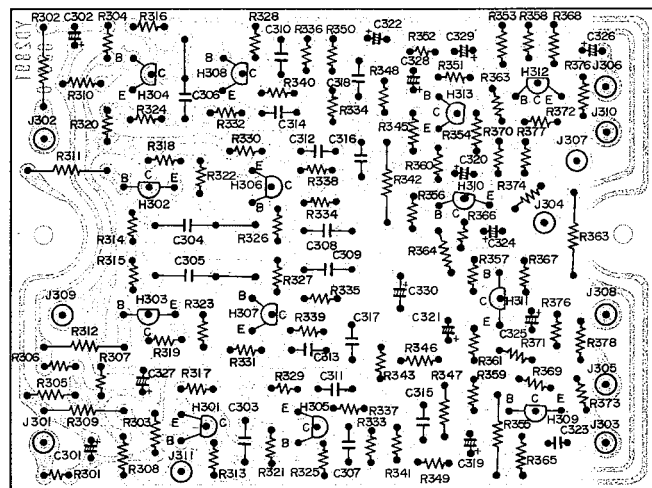

Figure 9. SQ Decoder Assembly P300 Component Locations

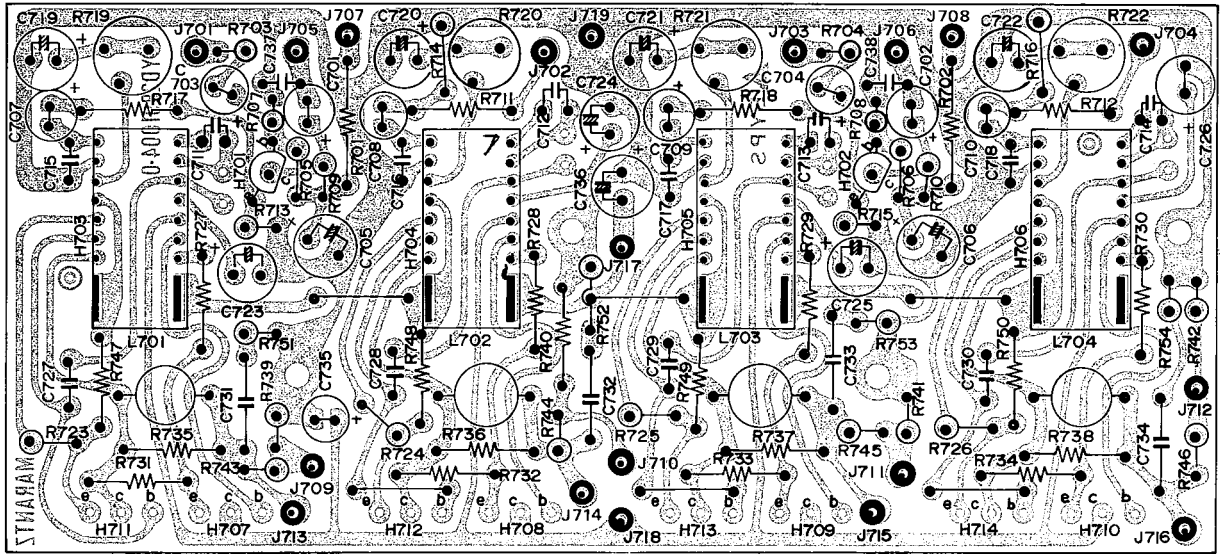

Figure 10. Power Amplifier Assembly P700 Component Locations

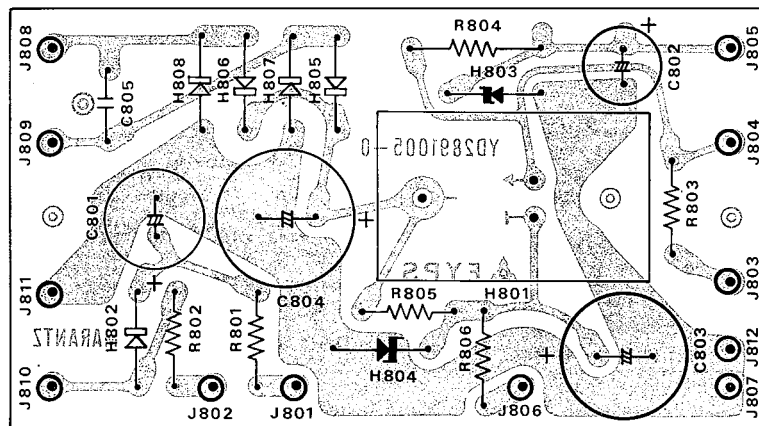

Figure 11. Power Supply Unit Assembly P800 Component Locations



Figure 12. Balance Control Unit Assembly PG01 Component Locations

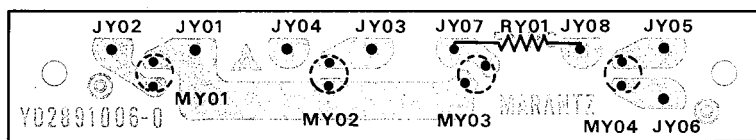

Figure 13. Indicator Lamps Assembly PY01 Component Locations

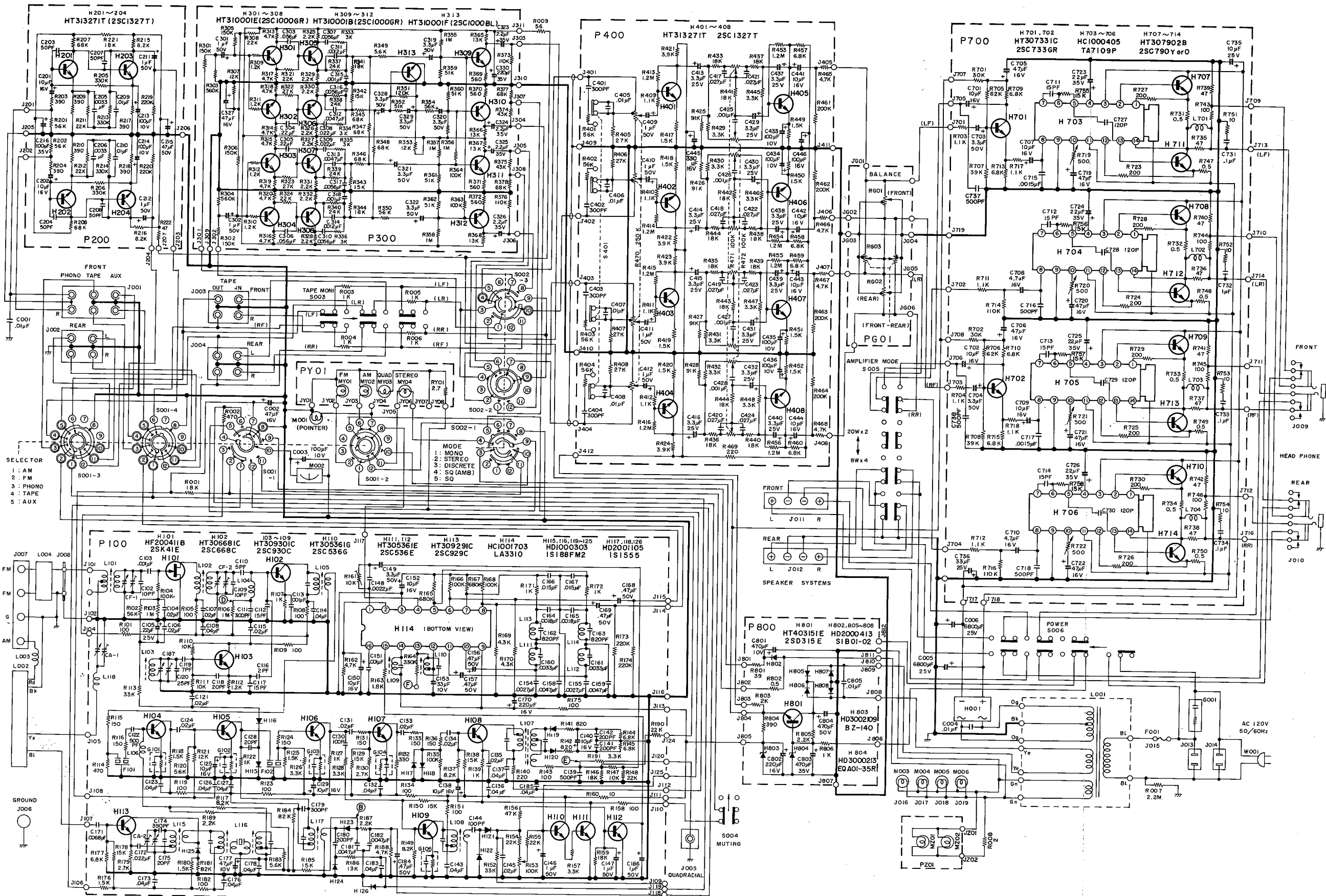

Figure 14. Schematic Diagram

PARTS LIST

REF. DESIG.	PART NO.	DESCRIPTION
A	289106340	Front Panel Assembly, For U.S.A.
0103	289106301	Escutcheon
0104	282740101	Frame
0105	282715801	Window
0106	281825905	Bush x 4
0107	273125901	Bush x 2
0108	285025901	Bush x 3
0110	289105303	Cover
A1	289106341	Front Panel Assembly, For CANADA
0103	289106301	Escutcheon
0104	282740101	Frame
0105	282715801	Window
0106	281825905	Bush x 4
0107	273125901	Bush x 2
0108	285025901	Bush x 3
B	285027340	Fly Wheel Assembly
0428	257706302	Escutcheon x 2
0429	257727301	Fly Wheel
0430	285011201	Shaft
0607	53110603E	Hexagon Nut
0609	54020601E	Flat Washer P
C	120200640	String Assembly
0517	120225801	Hook
0519	72080802A	String
D	285010341	Pointer Assembly
0528	281810301	Pointer
0529	285010301	Pointer
0530	281805301	Cover
M001	IN1008030	Lamp
E	289116040	Bracket Assembly
0703	289116001	Bracket
0815	55060365S	T.R. Rivet x 4
J013	YJ0400018	Jack
J014	YJ0400018	Jack
P100	YD2886001	P.W. Board, FM & AM Tuner
	ZZ2891101	P.W. Board Assembly
		RESISTORS
		All resistors are $\pm 5\%$ and $\frac{1}{4}W$, unless otherwise indicated.
R101	RT0510114	100 Ω
R102	RT0556314	56K Ω
R103	RT0510514	1M Ω
R104	RT0510414	100K Ω
R105	RT0510114	100 Ω
R106	RT0510514	1M Ω
R107	RT0510214	1K Ω
R108	RT0510114	100 Ω
R109	RT0510114	100 Ω
R110	RT0510314	10K Ω
R111	RT0510314	10K Ω
R112	RT0512214	1.2K Ω
R113	RT0533314	33K Ω
R114	RT0547114	470 Ω

REF. DESIG.	PART NO.	DESCRIPTION
R115	RT0515114	150 Ω
R116	RT0515114	150 Ω
R117	RT0582214	8.2K Ω
R118	RT0515214	1.5K Ω
R119	RT0510114	100 Ω
R120	RT0556214	5.6K Ω
R121	RT0512314	12K Ω
R122	RT0510214	1K Ω
R123	RT0510114	100 Ω
R124	RT0515114	150 Ω
R125	RT0533114	330 Ω
R126	RT0533214	3.3K Ω
R127	RT0510214	1K Ω
R128	RT0533214	3.3K Ω
R129	RT0515314	15K Ω
R130	RT0527214	2.7K Ω
R131	RT0515114	150 Ω
R132	RT0533114	330 Ω
R133	RT0515114	150 Ω
R134	RT0510114	100 Ω
R135	RT0510414	100K Ω
R136	RT0515114	150 Ω
R137	RT0582214	8.2K Ω
R138	RT0515314	15K Ω
R139	RT0510214	1K Ω
R140	RT0522114	220 Ω
R141	RT0582114	820 Ω
R142	RT0582114	820 Ω
R143	RT0510114	100 Ω
R144	RT0568214	6.8K Ω
R145	RT0568214	6.8K Ω
R146	RT0518314	18K Ω
R147	RT0510314	10K Ω
R148	RT0522314	22K Ω
R149	RT0582214	8.2K Ω
R150	RT0515314	15K Ω
R151	RT0510114	100 Ω
R152	RT0533314	33K Ω
R153	RA0104015	Trimming, 100K Ω (B)
R154	RT0522314	22K Ω
R155	RT0522314	22K Ω
R156	RT0547314	47K Ω
R157	RT0533214	3.3K Ω
R158	RT0510114	100 Ω
R159	RT0518314	18K Ω
R160	RT0510014	10 Ω
R161	RA0103020	Trimming, 10K Ω (B)
R162	RT0547214	4.7K Ω
R163	RT0515214	1.5K Ω
R164	RC1033412	330K $\Omega \pm 10\%$, $\frac{1}{2}W$
R165	RT0568414	680K Ω
R166	RT0510414	100K Ω
R167	RT0568414	680K Ω
R168	RT0510414	100K Ω
R169	RT0543214	4.3K Ω
R170	RT0543214	4.3K Ω
R171	RT0510214	1K Ω
R172	RT0510214	1K Ω
R173	RT0522414	220K Ω
R174	RT0522414	220K Ω
R175	RT0510114	100 Ω
R176	RT0515214	1.5K Ω

REF. DESIG.	PART NO.	DESCRIPTION	REF. DESIG.	PART NO.	DESCRIPTION
R177	RT0568214	6.8K Ω	C143	DK1840302	Ceramic, 0.04 μ F +80%, -20%
R178	RT0515314	15K Ω	C144	DD1610101	Ceramic, 100PF \pm 10%
R179	RT0527214	2.7K Ω	C145	DK1820302	Ceramic, 0.02 μ F +100%, -0%
R180	RT0515214	1.5K Ω	C146	EA1050509	Electroly, 1 μ F, 50V
R181	RT0582314	82K Ω	C147	EA1050509	Electroly, 1 μ F, 50V
R182	RT0510114	100 Ω	C148	DF1722201	Film, 0.0022 μ F \pm 20%
R183	RT0556214	5.6K Ω	C149	EA3350509	Electroly, 3.3 μ F, 50V
R184	RT0582314	82K Ω	C150	EA1060169	Electroly, 10 μ F, 16V
R185	RT0515314	15K Ω	C151	DF1610201	Film, 0.001 μ F \pm 10%
R186	RT0513314	13K Ω	C152	EA1060169	Electroly, 10 μ F, 16V
R187	RT0522214	2.2K Ω	C153	EA3360109	Electroly, 33 μ F, 10V
R188	RT0547214	4.7K Ω	C154	DF1627201	Film, 0.0027 μ F \pm 10%
R189	RT0522214	2.2K Ω	C155	DF1627201	Film, 0.0027 μ F \pm 10%
R190	RT0522314	22K Ω	C156	EA4740501	Electroly, 0.47 μ F, 50V
R191	RT0533214	3.3K Ω	C157	EA4740501	Electroly, 0.47 μ F, 50V
R192	RT0515214	1.5K Ω	C158	DF1647201	Film, 0.0047 μ F \pm 10%
R193	RT0527414	270K Ω	C159	DF1647201	Film, 0.0047 μ F \pm 10%
R194	RT0510414	100K Ω	C160	DF1533205	Film, 0.0033 μ F \pm 5%
CAPACITORS			C161	DF1533205	Film, 0.0033 μ F \pm 5%
C101	CA3240007	Variable, FM-3, AM-2	C162	DF5582101	Film, 820PF \pm 5%
C102	DD1210001	Ceramic, 10PF \pm 10%	C163	DF5582101	Film, 820PF \pm 5%
C103	DK1710201	Ceramic, 0.001 μ F \pm 20%	C164	DF1618205	Film, 0.0018 μ F \pm 10%
C104	DK1820302	Ceramic, 0.02 μ F +100%, -0%	C165	DF1618205	Film, 0.0018 μ F \pm 10%
C105	EM2240251	Electroly, 0.22 μ F, 25V	C166	DF1615301	Film, 0.015 μ F \pm 10%
C106	DK1820302	Ceramic, 0.02 μ F +100%, -0%	C167	DF1615301	Film, 0.015 μ F \pm 10%
C107	DK1820302	Ceramic, 0.02 μ F +100%, -0%	C168	EA4740501	Electroly, 0.47 μ F, 50V
C108	DK1840302	Ceramic, 0.04 μ F +80%, -20%	C169	EA4740501	Electroly, 0.47 μ F, 50V
C109	DD1210001	Ceramic, 10PF \pm 10%	C170	EA2270169	Electroly, 220 μ F, 16V
C110	DD1105001	Ceramic, 5PF \pm 0.5PF	C171	DF1768201	Film, 0.0068 μ F \pm 20%
C111	DD1530101	Ceramic, 300PF \pm 5%	C172	DF1722301	Film, 0.022 μ F \pm 20%
C112	DD1615003	Ceramic, 15PF \pm 10%	C173	DF1740301	Film, 0.04 μ F \pm 20%
C113	DK1710201	Ceramic, 0.001 μ F \pm 20%	C174	DF6539101	Film, 390PF \pm 5%
C114	DK1840302	Ceramic, 0.04 μ F +80%, -20%	C175	DD1620001	Ceramic, 20PF \pm 10%
C115	DK1820302	Ceramic, 0.02 μ F +100%, -0%	C176	DF1740301	Film, 0.04 μ F \pm 20%
C116	DD1102004	Ceramic, 2PF \pm 0.5PF	C177	EA4760109	Electroly, 47 μ F, 10V
C117	DD1615003	Ceramic, 15PF \pm 10%	C178	DK1840302	Ceramic, 0.04 μ F +80%, -20%
C118	DD1520001	Ceramic, 20PF \pm 5%	C179	DD1530101	Ceramic, 300PF \pm 5%
C119	DD1207003	Ceramic, 7PF \pm 1PF	C180	DD1620101	Ceramic, 200PF \pm 10%
C120	DD1525003	Ceramic, 25PF \pm 5%	C181	DF1647201	Film, 0.0047 μ F \pm 10%
C121	DK1820302	Ceramic, 0.02 μ F +100%, -0%	C182	DF1647201	Film, 0.0047 μ F \pm 10%
C122	DD1650101	Ceramic, 500PF \pm 10%	C183	DK1840302	Ceramic, 0.04 μ F +80%, -20%
C123	DK1840302	Ceramic, 0.04 μ F +80%, -20%	C184	EA4740501	Electroly, 0.47 μ F, 50V
C124	DK1820302	Ceramic, 0.02 μ F +100%, -0%	C185	DK1840302	Ceramic, 0.04 μ F +80%, -20%
C125	EA1060169	Electroly, 10 μ F, 16V	C186	EA1050509	Electroly, 1 μ F, 50V
C126	DK1840302	Ceramic, 0.04 μ F +80%, -20%	C187	CT1100008	Trimming, FM OSC
C127	DK1840302	Ceramic, 0.04 μ F +80%, -20%	C188	DK1710301	Ceramic, 0.01 μ F \pm 20%
C128	DD1620001	Ceramic, 20PF \pm 10%	PRINTED COMPO. & CERAMIC FILTERS		
C129	EA1060169	Electroly, 10 μ F, 16V	G101	BF4030001	Printed Compo., 0.04 μ F + 270 Ω
C130	DD1610101	Ceramic, 100PF \pm 10%	G102	BF2230008	Printed Compo., 0.022 μ F + 270 Ω
C131	DK1820302	Ceramic, 0.02 μ F +100%, -0%	G103	BF2230007	Printed Compo., 0.022 μ F + 680 Ω
C132	DK1840302	Ceramic, 0.04 μ F +80%, -20%	G104	BF2230006	Printed Compo., 0.022 μ F + 1K Ω
C133	DK1820302	Ceramic, 0.02 μ F +100%, -0%	G105	BF2230006	Printed Compo., 0.022 μ F + 1K Ω
C134	DK1820302	Ceramic, 0.02 μ F +100%, -0%	F101	FF1107004	Ceramic Filter, CFS107M
C135	DK1820302	Ceramic, 0.02 μ F +100%, -0%	F102	FF1107004	Ceramic Filter, CFS107M
C136	DK1840302	Ceramic, 0.04 μ F +80%, -20%	COILS & TRANSFORMERS		
C137	DK1840302	Ceramic, 0.04 μ F +80%, -20%	L101	LA1004606	Ant. Coil, FM
C138	EA1060169	Electroly, 10 μ F, 16V	L102	LA1027809	RF Coil, FM
C139	DD1650101	Ceramic, 500PF \pm 10%	L103	LO1203601	OSC Coil, FM
C140	EA1060169	Electroly, 10 μ F, 16V	L104	LC1751001	Choke Coil, 0.75mH
C141	DD1620101	Ceramic, 200PF \pm 10%	L105	LI1001601	IFT, FM
C142	DD1620101	Ceramic, 200PF \pm 10%			

REF. DESIG.	PART NO.	DESCRIPTION
L106	LC1223002	Choke Coil, 22 μ H
L107	LI1401623	IFT, FM
L108	LI1015602	IFT, FM
L109	LS1031001	MPX Coil, 19KHz
L110	LS1031004	MPX Coil, 38KHz
L111	LC2226004	Choke Coil, 22mH
L112	LC2226004	Choke Coil, 22mH
L113	LC2226004	Choke Coil, 22mH
L114	LC2226004	Choke Coil, 22mH
L115	LO1001042	OSC Coil, AM
L116	LI1028004	IFT, AM
L117	LI1001048	IFT, AM
L118	LC1332002	Choke Coil
SEMICONDUCTORS		
H101	HF200411B	FET, 2SK41E
H102	HT306681C	Transistor, 2SC668C
H103	HT309301C	Transistor, 2SC930C
H104	HT309301C	Transistor, 2SC930C
H105	HT309301C	Transistor, 2SC930C
H106	HT309301C	Transistor, 2SC930C
H107	HT309301C	Transistor, 2SC930C
H108	HT309301C	Transistor, 2SC930C
H109	HT309301C	Transistor, 2SC930C
H110	HT305361G	Transistor, 2SC536G
H111	HT305361E	Transistor, 2SC536E
H112	HT305361E	Transistor, 2SC536E
H113	HT309291C	Transistor, 2SC929C
H114	HC1001703	IC, LA3310
H115	HD1000303	Diode, 1S188FM2
H116	HD1000303	Diode, 1S188FM2
H117	HD2001105	Diode, 1S1555
H118	HD2001105	Diode, 1S1555
H119	HD1000303	Diode, 1S188FM2
H120	HD1000303	Diode, 1S188FM2
H121	HD1000303	Diode, 1S188FM2
H122	HD1000303	Diode, 1S188FM2
H123	HD1000303	Diode, 1S188FM2
H124	HD1000303	Diode, 1S188FM2
H125	HD1000303	Diode, 1S188FM2
H126	HD2001105	Diode, 1S1555
MISCELLANEOUS		
J101 }	YP1000113	Plug
J102		
J104 }	YP1000113	Plug
J121		
0939	62031650W	Lug
J124	YP1000113	Plug
J125	YP1000113	Plug
0906	282110901	Shield
0907	286710901	Shield
0937	62031650W	Lug
0938	62031650W	Lug
P200	YD2891010 ZZ2891010	P.W. Board, Phono P.W. Board Assembly

REF. DESIG.	PART NO.	DESCRIPTION
TRANSISTORS		
H201 }	HT313271T	2SC1327T
H204		
RESISTORS		
All resistors are $\pm 5\%$ and $\frac{1}{4}W$, unless otherwise indicated.		
R201	RT0556314	56K Ω
R202	RT0556314	56K Ω
R203	RT0539114	390 Ω
R204	RT0539114	390 Ω
R205	RN0533414	330K Ω
R206	RN0533414	330K Ω
R207	RN1068314	68K $\Omega \pm 10\%$, $\frac{1}{4}W$
R208	RN1068314	68K $\Omega \pm 10\%$, $\frac{1}{4}W$
R209	RT0539114	390 Ω
R210	RT0539114	390 Ω
R211	RT0522314	22K Ω
R212	RT0522314	22K Ω
R213	RN0533414	330K Ω
R214	RN0533414	330K Ω
R215	RT0582214	8.2K Ω
R216	RT0582214	8.2K Ω
R217	RT0539114	390 Ω
R218	RT0539114	390 Ω
R219	RT0522414	22K Ω
R220	RT0522414	22K Ω
R221	RT0518314	18K Ω
R222	RT0547014	47 Ω
CAPACITORS		
C201	EE1060162	Electroly, 10 μ F $\pm 20\%$, 16V
C202	EE1060162	Electroly, 10 μ F $\pm 20\%$, 16V
C203	DD1650001	Ceramic, 50PF $\pm 10\%$, 50V
C204	DD1650001	Ceramic, 50PF $\pm 10\%$, 50V
C205	DF1633205	Film, 0.0033 μ F $\pm 10\%$, 50V
C206	DF1633205	Film, 0.0033 μ F $\pm 10\%$, 50V
C207	DD1650001	Ceramic, 50PF $\pm 10\%$, 50V
C208	DD1650001	Ceramic, 50PF $\pm 10\%$, 50V
C209	DF1610305	Film, 0.01 μ F $\pm 10\%$, 50V
C210	DF1610305	Film, 0.01 μ F $\pm 10\%$, 50V
C211	EE1050501	Electroly, 1 μ F $\pm 20\%$, 50V
C212	EE1050501	Electroly, 1 μ F $\pm 20\%$, 50V
C213	EA1070109	Electroly, 100 μ F +100%, -10%, 10V
C214	EA1070109	Electroly, 100 μ F +100%, -10%, 10V
C215	EA4760509	Electroly, 47 μ F +100%, -10%, 50V
C216	EA1070359	Electroly, 100 μ F +100%, -10%, 35V
MISCELLANEOUS		
J201 }	YP1000113	Plug
J207		
1336	289110107	Support x 2
1337	51102605E	B.H.M. Screw x 2
1338	54022601E	Flat Washer P x 2
P300	YD2891009 ZZ2891009	P.W. Board, SQ P.W. Board Assembly

REF. DESIG.	PART NO.	DESCRIPTION
TRANSISTORS		
H301 ? H308 H309 H310 H311 H312 H313	HT310001E	2SC1000 GR
	HT310001B	2SC1000 GR
	HT310001B	2SC1000 GR
	HT310001B	2SC1000 GR
	HT310001B	2SC1000 GR
	HT310001F	2SC1000 BL
CAPACITORS		
C301	EA1050509	Electroly, 1 μ F +100%, -10%, 50V
C302	EA1050509	Electroly, 1 μ F +100%, -10%, 50V
C303	DF1556305	Film, 0.056 μ F \pm 5%, 50V
C304	DF1522405	Film, 0.22 μ F \pm 5%, 50V
C305	DF1522405	Film, 0.22 μ F \pm 5%, 50V
C306	DF1556305	Film, 0.056 μ F \pm 5%, 50V
C307	DF1556205	Film, 0.0056 μ F \pm 5%, 50V
C308	DF1522305	Film, 0.022 μ F \pm 5%, 50V
C309	DF1522305	Film, 0.022 μ F \pm 5%, 50V
C310	DF1556205	Film, 0.0056 μ F \pm 5%, 50V
C311	DF1512205	Film, 0.0012 μ F \pm 5%, 50V
C312	DF1547205	Film, 0.0047 μ F \pm 5%, 50V
C313	DF1547205	Film, 0.0047 μ F \pm 5%, 50V
C314	DF1512205	Film, 0.0012 μ F \pm 5%, 50V
C315	DF1510205	Film, 0.001 μ F \pm 5%, 50V
C316	DF1556205	Film, 0.0056 μ F \pm 5%, 50V
C317	DF1556205	Film, 0.0056 μ F \pm 5%, 50V
C318	DF1510205	Film, 0.001 μ F \pm 5%, 50V
C319	EA3350509	Electroly, 3.3 μ F +100%, -10%, 50V
C320	EA3350509	Electroly, 3.3 μ F +100%, -10%, 50V
C321	EA3350509	Electroly, 3.3 μ F +100%, -10%, 50V
C322	EA3350509	Electroly, 3.3 μ F +100%, -10%, 50V
C323	EE2250351	Electroly, 2.2 μ F \pm 20%, 35V
C324	EE2250351	Electroly, 2.2 μ F \pm 20%, 35V
C325	EE2250351	Electroly, 2.2 μ F \pm 20%, 35V
C326	EE2250351	Electroly, 2.2 μ F \pm 20%, 35V
C327	EA4760169	Electroly, 47 μ F +100%, -10%, 16V
C328	EA3350509	Electroly, 3.3 μ F +100%, -10%, 50V
C329	EA3350509	Electroly, 3.3 μ F +100%, -10%, 50V
C330	EA2270359	Electroly, 220 μ F +100%, -10%, 35V
RESISTORS		
All resistors are \pm 5% and $\frac{1}{4}$ W.		
R301	RT0515414	150K Ω
R302	RT0515414	150K Ω
R303	RT0556414	560K Ω
R304	RT0556414	560K Ω
R305	RT0515414	150K Ω
R306	RT0515414	150K Ω
R307	RT0512314	12K Ω
R308	RT0522314	22K Ω
R309	RT0512214	1.2K Ω
R310	RT0512214	1.2K Ω
R311	RT0512214	1.2K Ω
R312	RT0512214	1.2K Ω
R313	RT0547214	4.7K Ω
R314	RT0547214	4.7K Ω
R315	RT0547214	4.7K Ω
R316	RT0547214	4.7K Ω
R317	RT0547214	4.7K Ω
R318	RT0547214	4.7K Ω
R319	RT0547214	4.7K Ω
R320	RT0547214	4.7K Ω

REF. DESIG.	PART NO.	DESCRIPTION
R321	RT0522314	22K Ω
R322	RT0527314	27K Ω
R323	RT0527314	27K Ω
R324	RT0522314	22K Ω
R325	RT0522214	2.2K Ω
R326	RT0522214	2.2K Ω
R327	RT0522214	2.2K Ω
R328	RT0522214	2.2K Ω
R329	RT0522214	2.2K Ω
R330	RT0522214	2.2K Ω
R331	RT0522214	2.2K Ω
R332	RT0522214	2.2K Ω
R333	RT0530214	3K Ω
R334	RT0530214	3K Ω
R335	RT0530214	3K Ω
R336	RT0530214	3K Ω
R337	RT0524314	24K Ω
R338	RT0524314	24K Ω
R339	RT0524314	24K Ω
R340	RT0524314	24K Ω
R341	RT0518314	18K Ω
R342	RT0515314	15K Ω
R343	RT0515314	15K Ω
R344	RT0518314	18K Ω
R345	RT0568314	68K Ω
R346	RT0568314	68K Ω
R347	RT0568314	68K Ω
R348	RT0568314	68K Ω
R349	RT0556314	56K Ω
R350	RT0556314	56K Ω
R351	RT0512514	120K Ω
R352	RT0551314	51K Ω
R353	RT0512314	12K Ω
R354	RT0556314	56K Ω
R355	RT0510514	1M Ω
R356	RT0510514	1M Ω
R357	RT0510514	1M Ω
R358	RT0510514	1M Ω
R359	RT0551314	51K Ω
R360	RT0551314	51K Ω
R361	RT0551314	51K Ω
R362	RT0551314	51K Ω
R363	RT0510414	100K Ω
R364	RT0510414	100K Ω
R365	RT0513314	13K Ω
R366	RT0513314	13K Ω
R367	RT0513314	13K Ω
R368	RT0513314	13K Ω
R369	RT0556114	560 Ω
R370	RT0556114	560 Ω
R371	RT0556114	560 Ω
R372	RT0556114	560 Ω
R373	RT0511414	110K Ω
R374	RT0543314	43K Ω
R375	RT0543314	43K Ω
R376	RT0511414	110K Ω
R377	RT0568314	68K Ω
R378	RT0568314	68K Ω
MISCELLANEOUS		
J301 ?	YP1000113	Plug
J311		

REF. DESIG.	PART NO.	DESCRIPTION
P700	YD2891004 ZZ2891004	P.W. Board, Main Amp. P.W. Board Assembly
		RESISTORS All resistors are $\pm 5\%$ and $\frac{1}{4}W$, unless otherwise indicated.
R701	RT0530314	30K Ω
R702	RT0530314	30K Ω
R703	RT0511214	1.1K Ω
R704	RT0511214	1.1K Ω
R705	RT0562314	62K Ω
R706	RT0562314	62K Ω
R707	RT0539314	39K Ω
R708	RT0539314	39K Ω
R709	RT0568214	6.8K Ω
R710	RT0568214	6.8K Ω
R711	RT0511214	1.1K Ω
R712	RT0511214	1.1K Ω
R713	RT0568214	6.8K Ω
R714	RT0511414	110K Ω
R715	RT0568214	6.8K Ω
R716	RT0511414	110K Ω
R717	RT0511214	1.1K Ω
R718	RT0511214	1.1K Ω
R719	RA0501005	Trimming, 500 Ω (B)
R720	RA0501005	Trimming, 500 Ω (B)
R721	RA0501005	Trimming, 500 Ω (B)
R722	RA0501005	Trimming, 500 Ω (B)
R723	RT0520114	200 Ω
R724	RT0520114	200 Ω
R725	RT0520114	200 Ω
R726	RT0520114	200 Ω
R727	RT0520114	200 Ω
R728	RT0520114	200 Ω
R729	RT0520114	200 Ω
R730	RT0520114	200 Ω
R731	RW1000503	0.5 Ω \pm 10%, 3W
R732	RW1000503	0.5 Ω \pm 10%, 3W
R733	RW1000503	0.5 Ω \pm 10%, 3W
R734	RW1000503	0.5 Ω \pm 10%, 3W
R735	RC1047012	47 Ω \pm 10%, $\frac{1}{2}W$
R736	RC1047012	47 Ω \pm 10%, $\frac{1}{2}W$
R737	RC1047012	47 Ω \pm 10%, $\frac{1}{2}W$
R738	RC1047012	47 Ω \pm 10%, $\frac{1}{2}W$
R739	RC1047012	47 Ω \pm 10%, $\frac{1}{2}W$
R740	RC1047012	47 Ω \pm 10%, $\frac{1}{2}W$
R741	RC1047012	47 Ω \pm 10%, $\frac{1}{2}W$
R742	RC1047012	47 Ω \pm 10%, $\frac{1}{2}W$
R743	RJ1010101	100 Ω \pm 10%, 1W
R744	RJ1010101	100 Ω \pm 10%, 1W
R745	RJ1010101	100 Ω \pm 10%, 1W
R746	RJ1010101	100 Ω \pm 10%, 1W
R747	RW1000503	0.5 Ω \pm 10%, 3W
R748	RW1000503	0.5 Ω \pm 10%, 3W
R749	RW1000503	0.5 Ω \pm 10%, 3W
R750	RW1000503	0.5 Ω \pm 10%, 3W
R751	RC1010012	10 Ω \pm 10%, $\frac{1}{2}W$
R752	RC1010012	10 Ω \pm 10%, $\frac{1}{2}W$
R753	RC1010012	10 Ω \pm 10%, $\frac{1}{2}W$
R754	RC1010012	10 Ω \pm 10%, $\frac{1}{2}W$
		CAPACITORS
C701	EA1060169	Electroly, 10 μF +100%, -10%, 16V

REF. DESIG.	PART NO.	DESCRIPTION
C702	EA1060169	Electroly, 10 μF +100%, -10%, 16V
C703	EE3350501	Electroly, 3.3 μF \pm 20%, 50V
C704	EE3350501	Electroly, 3.3 μF \pm 20%, 50V
C705	EA4760169	Electroly, 47 μF +100%, -10%, 16V
C706	EA4760169	Electroly, 47 μF +100%, -10%, 16V
C707	EE1060162	Electroly, 10 μF \pm 20%, 16V
C708	EQ4750161	Electroly, 4.7 μF \pm 30%, 16V
C709	EE1060162	Electroly, 10 μF \pm 20%, 16V
C710	EQ4750161	Electroly, 4.7 μF \pm 30%, 16V
C711	DD1515001	Ceramic, 15PF \pm 5%, 50V
C712	DD1515001	Ceramic, 15PF \pm 5%, 50V
C713	DD1515001	Ceramic, 15PF \pm 5%, 50V
C714	DD1515001	Ceramic, 15PF \pm 5%, 50V
C715	DF1615205	Film, 0.0015 μF \pm 10%, 50V
C716	DD1650101	Ceramic, 500PF \pm 10%, 50V
C717	DF1615205	Film, 0.0015 μF \pm 10%, 50V
C718	DD1650101	Ceramic, 500PF \pm 10%, 50V
C719	EA4760169	Electroly, 47 μF +100%, -10%, 16V
C720	EA4760169	Electroly, 47 μF +100%, -10%, 16V
C721	EA4760169	Electroly, 47 μF +100%, -10%, 16V
C722	EA4760169	Electroly, 47 μF +100%, -10%, 16V
C723	EA2260359	Electroly, 22 μF +100%, -10%, 35V
C724	EA2260359	Electroly, 22 μF +100%, -10%, 35V
C725	EA2260359	Electroly, 22 μF +100%, -10%, 35V
C726	EA2260359	Electroly, 22 μF +100%, -10%, 35V
C727	DD1612101	Ceramic, 120PF \pm 10%, 50V
C728	DD1612101	Ceramic, 120PF \pm 10%, 50V
C729	DD1612101	Ceramic, 120PF \pm 10%, 50V
C730	DD1612101	Ceramic, 120PF \pm 10%, 50V
C731	DF1710405	Film, 0.1 μF \pm 20%, 50V
C732	DF1710405	Film, 0.1 μF \pm 20%, 50V
C733	DF1710405	Film, 0.1 μF \pm 20%, 50V
C734	DF1710405	Film, 0.1 μF \pm 20%, 50V
C735	EA1060259	Electroly, 10 μF +100%, -10%, 25V
C736	EA3360259	Electroly, 33 μF +100%, -10%, 25V
C737	DD1650101	Ceramic, 500PF \pm 10%, 50V
C738	DD1650101	Ceramic, 500PF \pm 10%, 50V
		SEMICONDUCTORS
H701	HT307331C	Transistor, 2SC733 GR
H702	HT307331C	Transistor, 2SC733 GR
H703	HC1000405	IC, TA7109P
H704	HC1000405	IC, TA7109P
H705	HC1000405	IC, TA7109P
H706	HC1000405	IC, TA7109P
H707	HT307902B	Transistor, 2SC790 O or Y
H708	HT307902B	Transistor, 2SC790 O or Y
H709	HT307902B	Transistor, 2SC790 O or Y
H710	HT307902B	Transistor, 2SC790 O or Y
H711	HT307902B	Transistor, 2SC790 O or Y
H712	HT307902B	Transistor, 2SC790 O or Y
H713	HT307902B	Transistor, 2SC790 O or Y
H714	HT307902B	Transistor, 2SC790 O or Y
		MISCELLANEOUS
L701	LC2103001	Choke Coil
L702	LC2103001	Choke Coil
L703	LC2103001	Choke Coil
L704	LC2103001	Choke Coil
J701		Plug
J719	YP1000113	Plug

REF. DESIG.	PART NO.	DESCRIPTION
1002	289126701	Heat Sink
1003	289126702	Heat Sink
1004	289110402	Retainer x 2
1005	289110103	Support x 4
1006	289112001	Insulator
1008	51060306A	P.H.M. Screw x 4
1009	51380306P	R.H. Tap Screw x 4
1010	51060306A	P.H.M. Screw x 4
1011	51380312P	R.H. Tap Screw x 5
1012	138200503	Clamper
2036	54050300R	T.L. Washer OR x 4
1017	289105304	Cover
1836	289100511	Clamper x 8
P800	YD2891005 ZZ2891005	P.W. Board, Power Supply, For U.S.A. P.W. Board Assembly, For U.S.A.
P800	YD2891008 ZZ2891008	P.W. Board, Power Supply, For CANADA P.W. Board Assembly, For CANADA
RESISTORS		
R801	GF0539014	39Ω ± 5%, ¼W
R802	RW1000503	0.5Ω ± 10%, 3W
R803	GU0520212	2KΩ ± 5%, ½W
R804	GJ1039102	390Ω ± 10%, 2W
R805	GF0522214	2.2KΩ ± 5%, ¼W
R806	GF0510212	1KΩ ± 5%, ½W
CAPACITORS		
C801	EA4770109	Electroly, 470μF +100%, -10%, 10V
C802	EA2270169	Electroly, 220μF +100%, -10%, 16V
C803	EA4770359	Electroly, 470μF +100%, -10%, 35V
C804	EA4770501	Electroly, 470μF +100%, -10%, 50V
C805	DK1810351	Ceramic, 0.01μF +100%, -0%, 500V
SEMICONDUCTORS		
H801	HT403151E	Transistor, 2SD315E
H802	HD2000413	Diode, S1B01-02
H803	HD3002109	Diode, BZ-140
H804	HD3000213	Diode, EQA01-35R
H805 }	HD2000413	Diode, S1B01-02
H808		
MISCELLANEOUS		
1015	273026702	Heat Sink
F801	FS1020005	Fuse, 2A, For CANADA
F802	FS1060002	Fuse, 6A, For CANADA
F803	FS1100002	Fuse, 10A, For CANADA
F804	FS1100002	Fuse, 10A, For CANADA
J801 }	YP1000113	Plug
J812		
J813 }	YP1000113	Plug, For CANADA
J816		
J817 }	YJ0800020	Socket, For CANADA
J824		
0403	289116050	Bracket K

REF. DESIG.	PART NO.	DESCRIPTION
0408	289120101	Partitioner
0409	289116007	Bracket
0410	289116008	Bracket
0412	289112201	Sticker
0421	257710602	Bearing
0422	141511801	Spacer
0432	284912001	Insulator
0433	289105101	Guide
0434	289100510	Clamper x 2
0435	289100401	Table x 2
S401	SP0401014	Push Switch
0510	289116052	Bracket K
0531	289105150	Guide K
1213	51570306B	P.H. Tapt Screw
0611	51040306A	F.H.M. Screw x 2
0613	51100306A	B.H.M. Screw x 2
0614	54050300R	T.L. Washer OR x 2
0615	51100306A	B.H.M. Screw x 6
0616	51100306A	B.H.M. Screw x 4
0617	51100204A	B.H.M. Screw x 6
0618	51100306A	B.H.M. Screw x 2
0619	51100306A	B.H.M. Screw x 4
0623	51100306A	B.H.M. Screw x 6
0625	51100306A	B.H.M. Screw x 2
0627	51100306A	B.H.M. Screw x 3
0628	51100306A	B.H.M. Screw
0423	281810650	Bearing K
0603	51640412D	Set Screw C.P.
0604	54040402N	Spring Washer
0605	53110403E	Hexagon Nut
0501	825016009	Bracket
0502	257726201	Pulley
0503	263711203	Shaft
0414	281827101	Holder
0418	289110106	Support
J016	YJ0800019	Socket
J017	YJ0800019	Socket
J018	YJ0800019	Socket
J019	YJ0800019	Socket
M003	IN1008007	Lamp
M004	IN1008007	Lamp
M005	IN1008007	Lamp
M006	IN1008007	Lamp
PZ01	YD2891007 ZZ2891007	P.W. Board, Meter Lamp P.W. Board Assembly
MISCELLANEOUS		
JZ01	YP1000113	Plug
JZ02	YP1000113	Plug
MZ01	IN1006302	Lamp
MZ02	IN1006302	Lamp
R008	RC1002012	Resistor, 2Ω ± 10%, ½W
PY01	YD2891006 ZZ2891006	P.W. Board, Selector Lamp P.W. Board Assembly

REF. DESIG.	PART NO.	DESCRIPTION
RY01	RC1002712	MISCELLANEOUS Resistor, 2.7Ω ± 10%, ½W
MY01	IN1006301	Lamp, FM, 40mA
MY02	IN1006301	Lamp, AM, 40mA
MY03	IN1006302	Lamp, Quad., 180mA
MY04	IN1006301	Lamp, Stereo, 40mA
JY01 } JY08	YP1000113	Plug
0413	282727401	Reflector
0415	289116011	Bracket
0522	282710701	Sheet
0630	51570305B	P.H. Tapt Screw x 4
0631	51570306B	P.H. Tapt Screw x 4
0632	51570315B	P.H. Tapt Screw
0633	51570306B	P.H. Tapt Screw x 2
0505	289116051	Bracket K
0514	127126201	Pulley
0515	263711203	Shaft
0620	51570306B	P.H. Tapt Screw x 2
PG01	YD2891003 ZZ2891003	P.W. Board, Balance P.W. Board Assembly
RG01	RX0503007	MISCELLANEOUS Variable Resist.
RG02	RX0503007	Variable Resist.
RG03	RS0503019	Variable Resist.
JG01 } JG06	YP1000113	Plug
M002	IM1104208	DC Meter, AM/FM
0416	285012003	Insulator
0417	285011801	Spacer
0419	289105305	Cover
C003	EA1070109	Electroly Cap., 100μF, 10V
S004	SP0201009	Push Switch, Muting
J009	YJ0100084	Jack, Headphone
J010	YJ0100084	Jack, Headphone
0411	289116006	Bracket
S006	SP0701001	Push Switch, Power
P400	YD2891002 ZZ2891002	P.W. Board, Tone Amp. P.W. Board Assembly
R401	RT0556314	56KΩ
R402	RT0556314	56KΩ
R403	RT0556314	56KΩ
R404	RT0556314	56KΩ
R405	RT0527314	27KΩ
R406	RT0527314	27KΩ
R407	RT0527314	27KΩ
R408	RT0527314	27KΩ
R409	RT0511214	1.1KΩ
R410	RT0511214	1.1KΩ

REF. DESIG.	PART NO.	DESCRIPTION
R411	RT0511214	1.1KΩ
R412	RT0511214	1.1KΩ
R413	RT0512514	1.2MΩ
R414	RT0512514	1.2MΩ
R415	RT0512514	1.2MΩ
R416	RT0512514	1.2MΩ
R417	RT0515214	1.5KΩ
R418	RT0515214	1.5KΩ
R419	RT0515214	1.5KΩ
R420	RT0515214	1.5KΩ
R421	RT0539214	3.9KΩ
R422	RT0539214	3.9KΩ
R423	RT0539214	3.9KΩ
R424	RT0539214	3.9KΩ
R425	RT0591314	91KΩ
R426	RT0591314	91KΩ
R427	RT0591314	91KΩ
R428	RT0591314	91KΩ
R429	RT0533214	3.3KΩ
R430	RT0533214	3.3KΩ
R431	RT0533214	3.3KΩ
R432	RT0533214	3.3KΩ
R433	RT0518314	18KΩ
R434	RT0518314	18KΩ
R435	RT0518314	18KΩ
R436	RT0518314	18KΩ
R437	RT0518314	18KΩ
R438	RT0518314	18KΩ
R439	RT0518314	18KΩ
R440	RT0518314	18KΩ
R441	RT0518314	18KΩ
R442	RT0518314	18KΩ
R443	RT0518314	18KΩ
R444	RT0518214	18KΩ
R445	RT0533214	3.3KΩ
R446	RT0533214	3.3KΩ
R447	RT0533214	3.3KΩ
R448	RT0533214	3.3KΩ
R449	RT0515214	1.5KΩ
R450	RT0515214	1.5KΩ
R451	RT0515214	1.5KΩ
R452	RT0515214	1.5KΩ
R453	RT0512514	1.2MΩ
R454	RT0512514	1.2MΩ
R455	RT0512514	1.2MΩ
R456	RT0512514	1.2MΩ
R457	RT0568214	6.8KΩ
R458	RT0568214	6.8KΩ
R459	RT0568214	6.8KΩ
R460	RT0568214	6.8KΩ
R461	RT0520414	200KΩ
R462	RT0520414	200KΩ
R463	RT0520414	200KΩ
R464	RT0520414	200KΩ
R465	RT0547214	4.7KΩ
R466	RT0547214	4.7KΩ
R467	RT0547214	4.7KΩ
R468	RT0547214	4.7KΩ
R469	RT0522114	220Ω
R470	RG0254003	Variable, 250KΩ (Volume)
R471	RG0104003	Variable, 100KΩ (Tone)
R472	RG0104003	Variable, 100KΩ (Tone)

REF. DESIG.	PART NO.	DESCRIPTION
H401 } H408	HT313271T	TRANSISTORS 2SC1327T
C401	DD1530102	Ceramic, 300PF ± 5%, 50V
C402	DD1530102	Ceramic, 300PF ± 5%, 50V
C403	DD1530102	Ceramic, 300PF ± 5%, 50V
C404	DD1530102	Ceramic, 300PF ± 5%, 50V
C405	DF1610305	Film, 0.01μF ± 10%, 50V
C406	DF1610305	Film, 0.01μF ± 10%, 50V
C407	DF1610305	Film, 0.01μF ± 10%, 50V
C408	DF1610305	Film, 0.01μF ± 10%, 50V
C409	EE1050501	Electroly, 1μF ± 20%, 50V
C410	EE1050501	Electroly, 1μF ± 20%, 50V
C411	EE1050501	Electroly, 1μF ± 20%, 50V
C412	EE1050501	Electroly, 1μF ± 20%, 50V
C413	EE3350251	Electroly, 3.3μF ± 20%, 25V
C414	EE3350251	Electroly, 3.3μF ± 20%, 25V
C415	EE3350251	Electroly, 3.3μF ± 20%, 25V
C416	EE3350251	Electroly, 3.3μF ± 20%, 25V
C417	DF1627305	Film, 0.027μF ± 10%, 50V
C418	DF1627305	Film, 0.027μF ± 10%, 50V
C419	DF1627305	Film, 0.027μF ± 10%, 50V
C420	DF1627305	Film, 0.027μF ± 10%, 50V
C421	DF1627305	Film, 0.027μF ± 10%, 50V
C422	DF1627305	Film, 0.027μF ± 10%, 50V
C423	DF1627305	Film, 0.027μF ± 10%, 50V
C424	DF1627305	Film, 0.027μF ± 10%, 50V
C425	DF1610205	Film, 0.001μF ± 10%, 50V
C426	DF1610205	Film, 0.001μF ± 10%, 50V
C427	DF1610205	Film, 0.001μF ± 10%, 50V
C428	DF1610205	Film, 0.001μF ± 10%, 50V
C429	EE3350251	Electroly, 3.3μF ± 20%, 25V
C430	EE3350251	Electroly, 3.3μF ± 20%, 25V
C431	EE3350251	Electroly, 3.3μF ± 20%, 25V
C432	EE3350251	Electroly, 3.3μF ± 20%, 25V
C433	EA1070109	Electroly, 100μF +100%, -10%, 10V
C434	EA1070109	Electroly, 100μF +100%, -10%, 10V
C435	EA1070109	Electroly, 100μF +100%, -10%, 10V
C436	EA1070109	Electroly, 100μF +100%, -10%, 10V
C437	EE3350251	Electroly, 3.3μF ± 20%, 25V
C438	EE3350251	Electroly, 3.3μF ± 20%, 25V
C439	EE3350251	Electroly, 3.3μF ± 20%, 25V
C440	EE3350251	Electroly, 3.3μF ± 20%, 25V
C441	EE1060162	Electroly, 10μF ± 20%, 16V
C442	EE1060162	Electroly, 10μF ± 20%, 16V
C443	EE1060162	Electroly, 10μF ± 20%, 16V
C444	EE1060162	Electroly, 10μF ± 20%, 16V
C445	EA3370169	Electroly, 330μF +100%, -10%, 16V
C446	EA1070169	Electroly, 100μF +100%, -10%, 16V
J401 } J412	YP1000113	MISCELLANEOUS Plug
0718	145525903	Bush x 2
J005	YT0201006	Terminal, Quadradial
J006	YT0101003	Terminal, Ground
J007	YT0104004	Terminal, Antenna
J008	YL0102003	Terminal, 2P
J011	YT0304001	Terminal, Speaker

REF. DESIG.	PART NO.	DESCRIPTION
J012	YT0304001	Terminal, Speaker
J015	YJ0800012	Socket, Fuse Holder
F001	FS1030006	Fuse, UL 3A
R007	RC1022512	Resistor, 2.2MΩ ± 10%, ½W
G001	BF1040001	Printed Compo., 0.1μF + 120Ω, 500V
L004	LB3007526	Balun Coil, FM
W001	YC0240010	AC Cord
S005	SS0802008	Slide Switch, SPK. Mode
0809	51100306S	B.H.M. Screw x 3
0812	54050400R	T.L. Washer OR
0814	62041760W	Lug
0820	51100308S	B.H.M. Screw x 2
0821	53110303E	Hexagon Nut x 2
0823	51100308S	B.H.M. Screw x 4
0824	53110303E	Hexagon Nut x 4
0832	51100303S	B.H.M. Screw x 2
0834	51100308S	B.H.M. Screw x 2
0835	53110303E	Hexagon Nut x 2
L002	LF1120024	Ant. Coil, AM
0710	257816052	Bracket K
0714	281927103	Holder
0802	51100308S	B.H.M. Screw x 2
0803	54050300R	T.L. Washer OR x 2
0804	53110303E	Hexagon Nut x 2
0806	51100310S	B.H.M. Screw x 2
0807	53110303E	Hexagon Nut x 2
L003	LC1154002	Choke Coil
1114	289116010	Bracket
1215	51100306A	B.H.M. Screw x 2
C001	DK1710301	Ceramic Cap., 0.01μF ± 20%, 50V
J001	YT0206003	Terminal, 6P, RCA Pin
J002	YT0204003	Terminal, 4P, RCA Pin
J003	YT0204003	Terminal, 4P, RCA Pin
J004	YT0204003	Terminal, 4P, RCA Pin
0731	289100502	Clamper x 3
0732	289100503	Clamper
0733	289112003	Insulator
S002	SR1005004	Rotary Switch, Mode
S001	SR1205003	Rotary Switch, Selector
R001	RT0518314	Resistor, 18KΩ ± 5%, ½W
R002	RT0539214	Resistor, 3.9KΩ ± 5%, ½W
C002	EA4760169	Electroly Cap., 47μF, 16V
S003	SP0601007	Push Switch, Tape Moni.
1117	289127101	Holder
R003	RT0510214	Resistor, 1KΩ ± 5%, ½W
R004	RT0510214	Resistor, 1KΩ ± 5%, ½W
R005	RT0510214	Resistor, 1KΩ ± 5%, ½W
R006	RT0510214	Resistor, 1KΩ ± 5%, ½W
R009	RT0556014	Resistor, 56Ω ± 5%, ½W
H001	HD2001510	Diode, 5B-1
C004	DK1810351	Ceramic Cap., 0.01μF, 500V
0903	282715901	Drum
0904	71101569M	Spring
0905	51064019A	Screw x 2
0523	289130201	Dial
0525	282705302	Cover
5636	138200503	Clamper, For CANADA
W002	YW2891001	Wire Material
W003	YX2891101	Wire Material
W008	YX2891002	Wire Material
W010	YX2891102	Wire Material
0909	289110902	Shield

REF. DESIG.	PART NO.	DESCRIPTION
0910	51570305B	P.H. Tapt Screw x 4
0911	51570306B	P.H. Tapt Screw x 2
0913	62031650W	Lug
0914	54060300R	T.L. Washer IR x 2
5736	51570306B	P.H. Tapt Screw, For CANADA
1102	289110550	Chassis K
1113	289116009	Bracket
1118	289135401	Lever
1122	138200503	Clamper x 4
1123	62031650W	Lug x 3
5836	203912001	Insulator
5837	282812003	Insulator
1128	289110403	Retainer x 2
0826	51100306S	B.H.M. Screw x 4
0829	51100306S	B.H.M. Screw x 4
5838	51102605E	B.H.M. Screw x 2
5839	54042602N	Spring Washer x 2
0209	51490410S	B.H.M. Screw F.S. x 4
0331	951022101	Label x 2, For CANADA
0332	951061114	Label, For CANADA
0122	275905701	Leg x 4
C005	EC6880251	Electroly Cap., 6800µF, 25V
C006	EC6880251	Electroly Cap., 6800µF, 25V
L001	TS1960407	Power Transf.
L001	TS1960408	Power Transf., For CANADA
1202	54020401E	Flat Washer P x 4
1203	54040402N	Spring Washer x 4
1204	53110401E	Hexagon Nut x 4
1205	51570306B	P.H. Tapt Screw x 4
1206	51570310B	P.H. Tapt Screw x 2
1210	51570306B	P.H. Tapt Screw x 8
1211	51100306S	B.H.M. Screw x 6
1212	51570306B	P.H. Tapt Screw x 3
1217	51570306B	P.H. Tapt Screw x 4
1220	51570306B	P.H. Tapt Screw x 2
1222	51100306A	B.H.M. Screw x 14
6036	59030805P	Fiver Washer
6037	288686101	Label
1230	51570306B	P.H. Tapt Screw x 10
1231	51570306B	P.H. Tapt Screw x 5
1232	54050300R	T.L. Washer OR
0518	56382540G	Eyelet
0635	56382540G	Eyelet
0818	51100306S	B.H.M. Screw x 2
0431	285011202	Shaft
6036	54040402N	Spring Washer
6137	289111501	Spring
6138	282711801	Spacer
0202	51122608E	T.H.M. Screw x 4
0204	51100406S	B.H.M. Screw x 8
0206	51480406S	B.H.M. Screw F x 4
0214	52010420A	H. Head Bolt x 4, For CANADA
0215	54080400R	T.L. Washer RR x 4, For CANADA
1422	952281501	Serial NO Card x 4
1423	952301512	Serial NO Card x 4, For CANADA
0111	281815401	Knob x 3
0112	281815402	Knob
0113	282815402	Knob x 2
0114	285015401	Knob x 4
0115	289115401	Knob x 3
0116	289125701	Lid
0118	257711803	Spacer x 4

REF. DESIG.	PART NO.	DESCRIPTION
0119	289125702	Lid
0126	288506450	Case K, For CANADA
0130	288205701	Leg x 4, For CANADA
0132	280312001	Insulator
0302	289126501	Indicator
0303	289126502	Indicator, For CANADA
0311	257886101	Label, UL Caution
0312	257886102	Label, Do not remove cover.
0313	257886103	Label, See marking on bottom.
0314	250626506	Indicator, Do not use as handle.
0319	951091101	Label, For CANADA
0320	282186102	Label, For CANADA
0324	951110102	Label
0325	245786104	Label, For CANADA
0328	951091102	Label
1302	289185101	Instructions
1309	289185601	Schematic Diagram
1310	289185602	Schematic Diagram, For CANADA
1317	281885104	Instructions
1318	281885108	Instructions
1323	257785450	Guarantee Card K
1402	289180105	Packing Case
1403	289180106	Packing Case
1405	289180102	Packing Case, For CANADA
1406	289180112	Packing Case, For CANADA
1408	289180301	Partitioner x 2
1410	288280303	Partitioner x 2, For CANADA
1412	901383033	Polyethylen Bag
1413	901433533	Polyethylen Bag, For CANADA
1414	901302501	Polyethylen Bag x 2
1417	102980401	Sleeve
1419	273182101	Silicagel x 2
1420	281905601	Buffer
1431	EA0200007	Ext. Antennä, FM

TECHNICAL SPECIFICATIONS

FM SECTION

Tuning Frequency Range	88 — 108 MHz
IHF M Usable Sensitivity	5.0µV
IHF Selectivity	40 dB
Caputure Ratio	5.0 dB
Image Rejection Ratio at 106 MHz	35 dB
Signal to Noise Ratio (Mono)	55 dB
Signal to Noise Ratio (Stereo)	50 dB
Total Harmonic Distortion (Mono)	0.6%
Total Harmonic Distortion (Stereo)	1.0%
Frequency Response (ref. 75µ sec. de-emphasis)	50 Hz — 15 KHz ±2.5dB
Stereo Separation at 1 KHz	32 dB
Quadradiial Output (400 Hz 75 KHz dev.)	300 mV

AM SECTION

Tuning Frequency Range	540 — 1605 KHz
Usable Sensitivity	80µV
Selectivity	20 dB
Image Rejection Ratio at 1400 KHz	35 dB
Signal to Noise Ratio	40 dB
Frequency Response (-3 dB)	65 Hz — 3.5 KHz
Total Harmonic Distortion	1.5%

AUDIO SECTION

Input Impedance — Low level input	Phono 47K ohm
— High level input	100K ohm
Input Sensitivity — Phono	2.2 mV for 8W output
— High level	150 mV for 8W output
Frequency Response	±2.0 dB, 20 Hz to 20 KHz at 1W output
Intermodulation Distortion	Less than 0.9% at rated power output from 40 Hz to 16 KHz with all channels driven (S.M.P.T.E.)
Total Harmonic Distortion	Less than 0.9% at rated power output 40 Hz to 20 KHz with all channel driven
Damping Factor	Greater than 45 into 8 ohms load
Total Noise — From magnetic phono input	Less than 3µV equivalent input to rated power amp output into 8 ohms load
Volume Tracking	Within 3 dB
Rated Continuous (RMS) Output	
Per channel, all channels operating simultaneously	8W at 4 and 8 ohms 4W at 16 ohms
Comparable Total Music Power	45W at 8 ohms

GENERAL

Power Requirements	120V AC 50 to 60 Hz
--------------------	---------------------

Power Consumption – at rated power output, all channels	220 watts
– idling (no signal)	20 watts
Dimensions – Panel Width	14-11/64 inches
– Panel Height	4-23/32 inches
– Depth	11-1/32 inches
Weight-Unit alone	20.9 lbs
Packed for shipment	26.5 lbs

*These specifications and exterior designs may be changed for improvement without advance notice.



marantz.

MARANTZ CO., INC. • P.O. BOX 99 • SUN VALLEY, CALIFORNIA • 91352

A WHOLLY-OWNED SUBSIDIARY OF SUPERSCOPE INC., SUN VALLEY, CALIFORNIA 91352