

43

EP
S/O

SERVICE MANUAL 2230

marantz

model 2230

Stereophonic Receiver

TABLE OF CONTENTS

SECTION	PAGE
Introduction	1
Service Notes	1
AM Tuner	1
FM Tuner	2
Phono and Pre-amplifier	4
Main Amplifier	4
Power Supply	5
Audio Trouble Analysis	5
Voltage Conversion	5
Test Equipment Required for Servicing	7
AM Alignment Procedure	8
FM Alignment Procedure	8
Stereo Separation Alignment	8
Audio Adjustment	9
Parts List	19
Specifications	28

LIST OF ILLUSTRATIONS

FIGURE	PAGE
1. Remove the Terminal Cover	5
2. Voltage Conversion Chart	6
3. Dial Stringing	9
4. Front Panel Adjustment and Component Locations	10
5. Main Chassis Component Locations (Top View)	10
6. Rear Panel Adjustment and Component Locations	11
7. Main Chassis Component Locations (Bottom View)	11
8. FM Front End Assembly P100 Component Locations	12
9. FM IF Amplifier Assembly P200 Component Locations	12
10. FM Detector Assembly P500 Component Locations	13
11. MPX Stereo Decoding Amplifier Assembly P300 Component Locations	13
12. Muting Control Amplifier Assembly P550 Component Locations	14
13. AM Tuner Unit Assembly P150 Component Locations	14
14. Phono Amplifier Assembly P700 Component Locations	15
15. Tone Amplifier Assembly P400 Component Locations	15
16. Tone Control Unit Assembly P450 Component Locations	16
17. Power Amplifier Assembly P750 Component Locations	17
18. Regulated Power Supply Assembly P800 Component Locations	17
19. Loudness, High and Low Filter Switch Unit Assembly P600 Component Locations	17
20. Schematic Diagram	18

INTRODUCTION

This service manual was prepared for use by Authorized Warranty Stations and contains service information for Marantz Model 2230 Stereophonic Receiver.

Service information and voltage data included in this manual are intended for use by the knowledgeable and experienced technician only. All instruction should be read carefully. No attempt should be made to proceed without a good understanding of the operation in the receiver.

The part lists furnish information by which replacement part may be ordered from the Marantz Company. A simple description is included for parts which can be usually be obtained through local suppliers.

1. Service Notes

As can be seen from the circuit diagram the chassis of Model 2230 consists of the following units. Each unit mounted on a printed circuit board is described within the square enclosed by a bold dotted line on the circuit diagram.

- | | |
|---|-----------------------------|
| 1. FM Front End | mounted on P.C. Board, P100 |
| 2. FM IF Amplifier | mounted on P.C. Board, P200 |
| 3. FM Detector | mounted on P.C. Board, P500 |
| 4. MPX Stereo Decoding Amplifier | mounted on P.C. Board, P300 |
| 5. Muting Control Amplifier | mounted on P.C. Board, P550 |
| 6. AM Tuner Unit | mounted on P.C. Board, P150 |
| 7. Phono Amplifier | mounted on P.C. Board, P700 |
| 8. Tone Amplifier | mounted on P.C. Board, P400 |
| 9. Tone Control Unit | mounted on P.C. Board, P450 |
| 10. Power Amplifier | mounted on P.C. Board, P750 |
| 11. Regulated Power Supply | mounted on P.C. Board, P800 |
| 12. Loudness, High and Low Filter Switch Unit | mounted on P.C. Board, P600 |

2. AM Tuner

All components except Tuning capacitor and ferrite bar antenna are mounted on a printed circuit board P150.

The AM signals induced in a ferrite bar antenna are applied to the base of RF amplifier transistor H151 through a capacitor of C151 and amplified to the level required for overcoming the conversion noises, thus giving good S/N performance. The tuned circuits inserted in both out and input circuit of the RF amplifier assure very high image and spurious rejection performance. Thus amplified and selected AM signals are then applied to the base of converter transistor H152 through a coupling capacitor C156. While the local oscillator voltage is injected to the emitter of H152 through a capacitor C157. Both AM signals and oscillating voltage are mixed at the base-emitter junction and converted into 455KHz intermediate frequency. The resulting IF signal is applied to the first IF transformer L153 consisting of one ceramic filter and two tuned circuits.

The output of L153 is led to the transistor H153 which in turn apply its output to the transistor of next stage H154. The fully amplified IF output is then applied to the diode H157 to detect audible signal through the detector transformer L154. The detected audio signal is filtered and amplified and the final audio output is obtained from the collector of H155 and applied: one to the tape out jacks through monitor switch on the front panel and the other to the function rotary switch.

The DC component of the detected IF signal is used as a AGC voltage to control emitter current of H153 which in turn control the bias current of the RF amplifier through the resistor R179 and R151. A part of IF signal output is also applied to the diode H158 through a capacitor C167 and rectified to obtain DC current for energizing the AM signal strength meter M001.

2.1 Suggestions for AM Tuner trouble shooting

Check for broken AM bar antenna, next try to tune station by rotating fly-wheel tuning knob slowly and observe the AM signal strength meter whether it deflects or not. If the signal strength meter gives a deflection at several frequencies received, no failure may exist in the stages at least preceding final IF transformer L154. Next connect a oscilloscope to the pin terminal J162 or J157 and check for audio signals with the tuning meter deflected. If the signal strength meter does not deflect, check the local oscillator circuit. Normal oscillating voltage at the hot end of the oscillator tuning capacitor is about 2 or 3 volts, varying with tuning capacitor position. When measuring oscillating voltage use a RF VTVM, no circuit tester gives correct indication. If the local oscillator voltage is normal, check all voltage distribution in the AM circuits by using a DC VTVM and compare the measured values with those given in the schematic diagram.

3. FM Tuner

The FM Tuner section of Model 2230 is divided into five functional blocks: FM Front End, IF Amplifier, Detector, Muting Control and MPX Stereo Decoding Circuit.

FM signals induced by a FM antenna are led to FM antenna coil L101 through an attenuator switch and a Balun coil. These signals are then applied to the FET RF amplifier which in turn applies its output to the next FET Mixer H102 through the double tuned high selective circuits. The FET Mixer convert its input signal into 10.7 MHz intermediate frequency and amplifies it at the same time. The H103 is a local oscillator and its output is injected into the source of the FET Mixer, the injection voltage is about 700mV. The 10.7 MHz front end output is led to the next IF amplifier unit through a coaxial cable.

The IF amplifier unit consists of five stages of IF amplifier, one stage of AGC amplifier. Six pieces of ceramic filters are also used to obtain high selectivity, four stages of symmetrical diode limiters are also employed for the best limiting characteristics, improved capture ratio and good AM suppression.

A part of FM Front End output is applied to the AGC amplifier H206 and rectified its output is fed back to the gate of FET RF amplifier to decrease the gain with increased signal strength.

The IF signal sufficiently amplified through every stage of IF amplifier is finally applied to the IC limiter on the Detector Unit. The detected audio output is led to the buffer amplifier H502 and its buffered output is led to; (a) noise amplifier H551 through resistor R551 and capacitor C551, (b) Quad Radial Jacks on the rear panel through resistor R564, (c) MPX stereo decoding circuit through R563.

3.1 Audio Muting and Stereo mode auto-selecting circuit

The muting circuit consisting of all solid-state electrical switching has been incorporated in the Model 2230. Two inputs control the muting function. The first is related to signal strength, the second to the noise condition at the detector. These inputs are properly matrixed and gated to provide muting free from noise and transients.

The first input of DC voltage obtained by rectifying a part of IF output signal from the H205 is applied to the base of H306 and turns on it, if the IF output is greater than predetermined level (muting threshold level). When the H306 is turned on the H307 is turned off, allowing the emitter-collector resistance increasing and the collector voltage rises about 9.0V. The increased collector voltage increases the gate bias voltage and turns on the switching FET H308, decreasing the source-drain resistance to near zero ohm and allowing the audio signal applied to the source to flow to the center of 38 KHz switching transformer through the source-drain path.

When the input signal is lower than predetermined level, the DC output obtained is small and can not turn on the H306, thus the H306 keeps its turn-off state and this makes H307 turn on, decreasing the collector voltage and turning off H308. Thus no audio signals can pass through the FET. This is the fundamental principle of the muting operation but for more elaborate muting operation the second input is necessary.

The second input is used to protect the muting operation and MPX stereo beacon lamps from misoperation due to undesirable noises. The high frequency noises included in the detected audio signals are separated by a small capacitor C551 and amplified by the noise amplifier transistor H551 and its output is rectified by the two diodes. The rectified DC output is proportional to the noise components in the audio signals.

When there are excessive noises in the audio signals such as obtained with a station incorrectly tuned in, the rectified DC output turns on the transistor H522, decreasing the emitter-collector resistance to zero. This means the collector of H307 is short-circuited to the ground, therefore the H308 is turned off and any audio signals having excessive high frequency noises can not go through the FET's sourcedrain path.

The transistor H303 connected in series with the 19 KHz pilot signal amplifier transistor H302 is also turned off and no current flows in the H302, resulting in turning off the stereo beacon lamps. Thus misoperation due to undesirable noises is also avoided.

3.2 MPX Stereo Decoding Circuit

The buffered and non-equalized audio signals are applied to the first amplifier H301 which serve as a tuned amplifier for the pilot signal in the composite signals and as a buffer amplifier for the audio signals. The amplified 19 KHz pilot signal is led to the second 19 KHz amplifier H302 and further amplified if switching transistor H303 is turned on by the controlling DC signal as described in the preceding chapter. The final 19 KHz pilot signal is rectified by the doubler circuit consisting of the H315 and H316 to obtain synchronized 38 KHz amplifier driving signal.

The H304 is the 38 KHz tuned amplifier and supplies its output to the switching matrix circuit consisting of four diodes. While the composite signals are applied to the center tap of switching transformer 1/2 L302. The right and left stereo signals decoded by the switching circuit are led to the crosstalk cancelling amplifier which utilizes complementary configuration with NPN and PNP transistors through de-emphasis network consisting of C315 and 335, and C316 and R336. L305 is a low-pass filter networks having very sharp cut off characteristics and eliminates undesirable residual switching signals. Transistors H313 and H314 are buffer amplifiers and their outputs are led to the function switch.

3.3 Suggestion for Trouble Shooting of FM Tuner

3.3.1 Symptom: No. FM Reception

First turn on the Power switch and try to tune FM stations. Rotate the fly-wheel tuning knob slowly and observe the FM signal strength meter and FM center tuning meter. If the signal strength meter deflects at several frequencies received, the tuner circuits preceding the discriminator circuit may have no failure. When no reading is obtained in both meters, check FM local oscillator circuit, using a RF VTVM. The normal local oscillator voltage is one or two volts (rms) at the tuning capacitor, depending on the tuning capacitor position. If the local oscillator voltage is normal, next check all voltage distribution in the FM Front End and IF amplifier unit and compare them with those shown in the circuit diagram. When signal strength meters deflects but no sound is obtained, check audio circuits, using high sensitive oscilloscope.

3.3.2 Symptom: No Stereo Separation

First check the "MONO" switch is in normal out position. Connect a FM RF signal generator output modulated by a stereo modulator to the rear FM antenna terminals, and check the stereo beacon is turned on or not. If not turned on, check for 19 KHz pilot signal and 38 KHz switching signal, using an oscilloscope.

4. Phono and Pre-amplifier

Signals from the tuner and AUX jacks are applied to the selector switch. Signals from the Phono jacks are applied to the phono-amplifier consisting of transistor H701, H703 and H705 and temperature compensating varistor-diodes H707 and H709. The gain of the amplifier is 40 dB. The amplified and equalized phono-signals are, then, fed to other section of the selector switch which, in turn, applies output signals from the tuner, phono-amplifier and AUX jacks to the TAPE MONITOR switch, TAPE OUT jacks and DUBBING OUT jack. The TAPE MONITOR switch, applies the signals decided by the selector switch to the DUBBING IN jack having built-in-switch which cuts off TAPE IN signals when an external plug is inserted into the DUBBING IN jack.

Signals from the DUBBING OUT or TAPE OUT jack are applied to the Balance and Volume control resistors through the TAPE MONITOR and MONO switch, then applied to the Pre-amplifier consisting of two stages of direct-coupled amplifiers (H401 and H403, H405 and H407). The tone control unit is provided between these two direct-coupled amplifiers. Frequency response of the amplifier can be varied by BASS, MIDDLE and TREBLE controls, and thus controlled output are then led to the PRE OUT jacks through High and Low pass filter pushswitch.

5. Main Amplifier

The pre-amplifier outputs are applied to the main amplifier through jumper plugs connected PRE OUT and MAIN IN jacks. Transistor H751 is a pre-driver coupled to the transistor H752 through capacitor C753. Transistor H752 drives the inverter transistor H755 and H756 which, in turn, drive the power stage consisting of H001 and H002. Transistors H753 and H754 are current limiters and operate as power protecting circuits.

Excessive currents flowing into the power stage are detected by the resistors R768 and R769 and the resultant variations are applied to the transistors H753 and H754 and make them turned on. This decreases the current flowing in the H755 and H756. In this way the currents flowing in the power stage (H001 and H002) are restricted within a safe value.

6. Power Supply

The power supply unit provides +14V DC for the Tuner and +35.6V DC for phono—and pre-amplifiers.

AC voltages of 34V X 2 applied to the H804 and H805 are rectified by a center-tapped full wave rectifying circuit, then stabilized by the circuit consisting of H802, H803 and H807. DC +14V is also stabilized by a zener diode H806.

7. Audio Trouble Analysis

- | | |
|--------------------------------------|--|
| 1. Excessive line consumption | a. Check for shorted rectifiers H007, H804, H805. |
| | b. Check for shorted transistors H001, H002. Check L004 for short. |
| 2. No line consumption or zero bias. | a. Check line cord, fuse, shorted H005, H757 |
| | b. Check for open rectifiers H007, H804, H805 or open L004. |
| 3. High hum and noise level. | a. Check filter capacitors C007, C752. |
| 4. Parastic oscillation | a. Check for defective C756, C762. |
| 5. Improper clipping | a. Check for proper adjustment R760. |

8. Voltage Conversion

This model is equipped with a universal power transformer to permit operation at 100, 120, 200, 220 and 240V AC 50 to 60Hz.

To convert the Model 2230 to the required voltage perform the following steps:

- (1) Remove the top cover.
- (2) Remove the Transformer Wire Connection Terminal Cover, loosen two Cover mounting screws on the rear panel, see Fig. 1.
- (3) Change the jumper wires as illustrated in Fig. 2 for the required AC voltage and replace the fuse as instructed.

CAUTION: DISCONNECT POWER SUPPLY CORD FROM AC OUTLET BEFORE CONVERTING VOLTAGE.

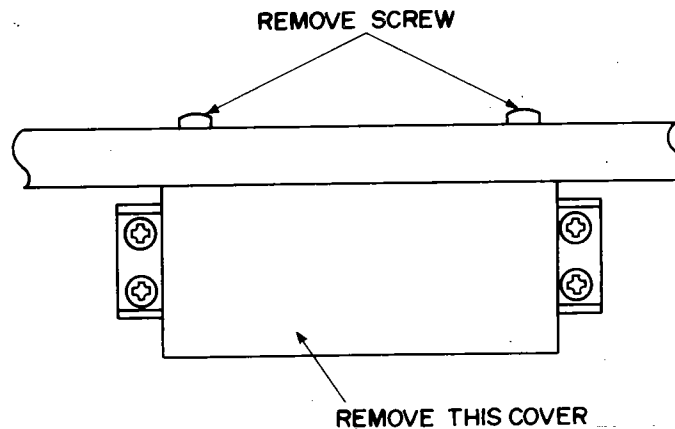
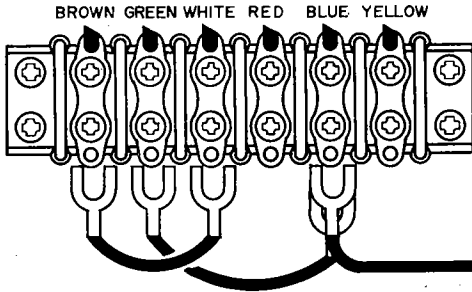
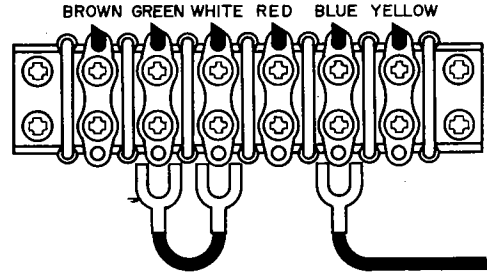

Figure 1. Remove the Terminal Cover

For 100 V Operation
(Use 3.5A Fuse)



For 200V Operation
(Use 2A Fuse)



For 120 V Operation
(Use 2.5A Fuse)

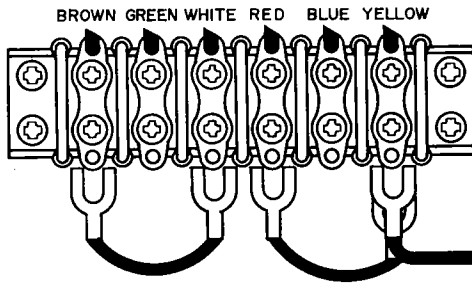

For 220 V Operation
(Use 1.5A Fuse)

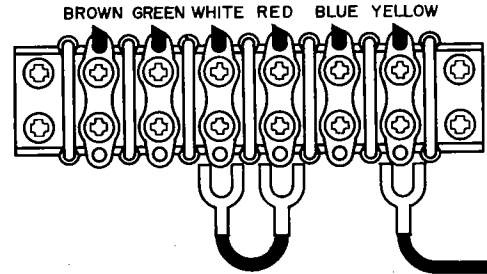

For 240V Operation
(Use 1.5A Fuse)

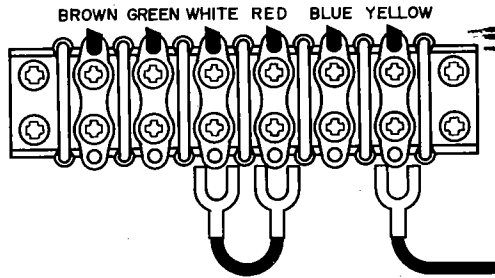

Figure 2. Voltage Conversion Chart

9. Test Equipment Required for Servicing

Table 1 lists the test equipment required for servicing the Model 2230 Receiver.

Item	Manufacturer and Model No.	Use
AM Signal Generator		Signal source for AM alignment
Test Loop		Used with AM Signal generator
FM Signal Generator	Less than 0.3% distortion	Signal source for FM alignment
Stereo Modulator	Less than 0.3% distortion	Stereo separation alignment and trouble shooting
Audio Oscillator	Weston Model CVO-100P, less than 0.02% residual distortion is required.	Sinewave and squarewave signal source.
Oscilloscope	High sensitivity with DC horizontal and vertical amplifiers.	Waveform analysis and Trouble Shooting, and ASO alignment.
VTVM	With AC, DC, RF range	Voltage measurements.
Circuit Tester		Trouble Shooting
AC Wattmeter	Simpson, Model 390	Monitors primary power to Amplifier.
AC Ammeter	Commercial Grade (1-10A)	Monitors amplifier output under short circuit condition.
Line Voltmeter	Commercial Grade (0-150VAC)	Monitors potential of primary power to amplifier
Variable Autotransformer (0-140VAC, 10 amps.)	Powerstat, Model 116B	Adjusts level of primary power to amplifier.
Shorting Plug	Use phono plug with 600 ohm across center pin and shell.	Shorts amplifier input to eliminate noise pickup.
Output Load (8 ohms, 0.5%, 100W)	Commercial Grade	Provides 8-ohm load for amplifier output termination.
Output Load (4 ohms, 0.5%, 100W)	Commercial Grade	Provides 4-ohm load for amplifier output termination.

10. AM Alignment Procedure

AM IF Alignment

1. Connect a sweep generator to the J151 and an alignment scope to the J162.
2. Rotate each core of IF transformer L153 and L154 for maximum height and flat top symmetrical response.

AM Frequency Range and Tracking Alignment

1. Set AM signal generator to 525 KHz. Turn the tuning capacitor fully closed (place the tuning pointer at the low end.) and adjust the oscillator coil L152 for maximum audio output.
2. Set the signal generator to 1650 KHz. Place the tuning pointer in the high frequency end and adjust the oscillator trimmer on the oscillator tuning capacitor for maximum audio output.
3. Repeat the step 1 and 2 until no further adjustment is necessary.
4. Set the generator to 600 KHz and tune the receiver to the same frequency and adjust a slug core of AM ferrite rod antenna and RF coil L151 for maximum output.
5. Set the generator to 1400 KHz and tune the receiver to the same frequency and adjust both trimming capacitors of Antenna and RF tuned circuit for maximum output.
6. Repeat the step 4 and 5 until no further adjustment is necessary.

Note: During tracking alignment reduce the signal generator output as necessary to avoid AGC action.

11. FM Alignment Procedure

1. Connect a FM signal generator to the FM antenna terminals and a oscilloscope and an audio distortion analyzer to the tape output jacks on the rear panel.
2. Set the FM SG to 87.5 MHz and provide about 3 to $5\mu\text{V}$. Place the tuning pointer at the low frequency end by rotating the tuning knob and adjust the core of oscillator coil L104 to obtain maximum audio output.
3. Set the FM SG to 108.5 MHz and provide about 3 to $5\mu\text{V}$ output. Rotate the tuning knob and place the tuning pointer at the high frequency end and adjust the trimming capacitor C106 for maximum output.
4. Repeat the step 2 and 3 until no further adjustment is necessary.
5. Set the FM SG to 90 MHz and tune the receiver to the same frequency. Decrease signal generator output until the audio output level decreases with the decreasing generator output. Adjust the antenna coil L101, RF coils L102 and L103 and IF transformer L105 for minimum audio distortion.
6. Set the FM SG to 106 MHz and tune the receiver to the same frequency. Adjust the trimming capacitor C102, C104 and C105 for minimum distortion.
7. Connect a DC VTVM with 1 V range selected to the pin terminal J504 and adjust the secondary core (black) of discriminator transformer L501 so that no voltage reading is obtained on the VTVM at no signal. Next set the FM SG to 98 MHz and increase its output level to $1\text{K}\mu\text{V}$, then, tune the receiver to the same frequency so that no deflection is obtained on the VTVM. Adjust the primary core (pink) of L501 for minimum distortion.

12. Stereo Separation Alignment

1. Set the FM SG to provide $1\text{K}\mu\text{V}$ at 98 MHz. Tune the receiver to the same frequency so that the VTVM connected to the pin terminal J504 will give no readings.
2. Modulate the FM SG with stereo composite signal consisting of only subchannel signal (of course a pilot signal must be included). Adjust the core of L301 for maximum audio output, then modulate the signal generator with a stereo composite signal consisting of only L channel signal and again adjust the core of L301 for maximum audio output.
3. Adjust the trimming resistor R365 for maximum and same separation in both channels.

13. Audio Adjustment

1. Voltage adjustment.

Connect a DC voltmeter between the J08 and Ground and adjust trimming resistor R810 for 35.6V.

2. Idle current adjustment.

Connect a VTVM across the resistor R774 and adjust the trimming resistor R765 until the VTVM reads 5 mV DC. For the other channel do the same adjustment.

3. Clipping level adjustment.

Connect an oscilloscope across the speaker terminals. Apply an audio signal of 1 KHz to the AUX jacks and increase the audio signal until the audio output on the oscilloscope begins to start clipping. Adjust the trimming resistor R760 for equal clipping. For the other channel proceed the same adjustment.

4. Phono-amplifier adjustment.

Connect an oscilloscope to the TAPE OUT jacks and an audio signal generator to the PHONO jacks. Place the selector switch in the PHONO position. Increase 1 KHz audio signal gradually until a slight clipping of the sine-wave is observed on the oscilloscope. Adjust the R708 for equal clipping level. For the other channel adjust R709.

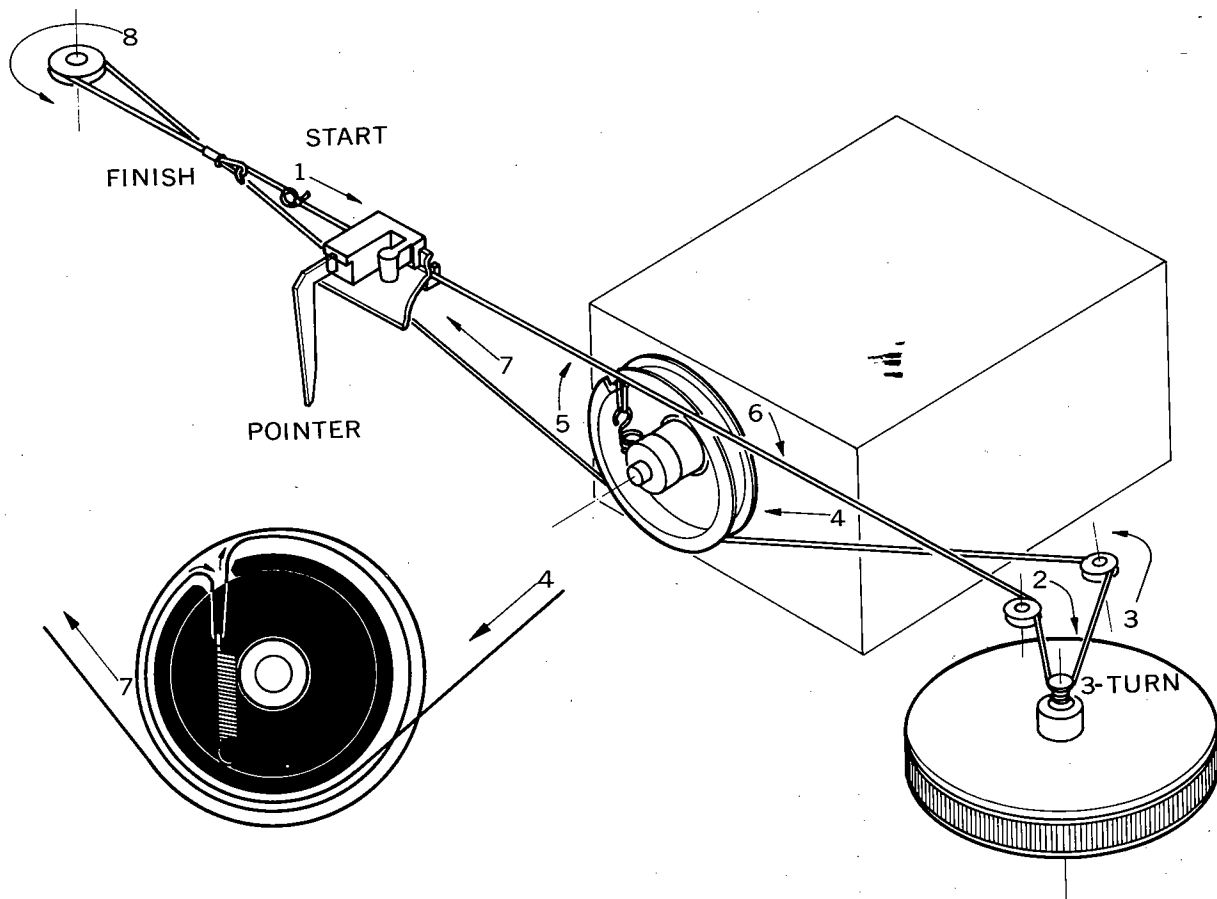

Figure 3. Dial Stringing

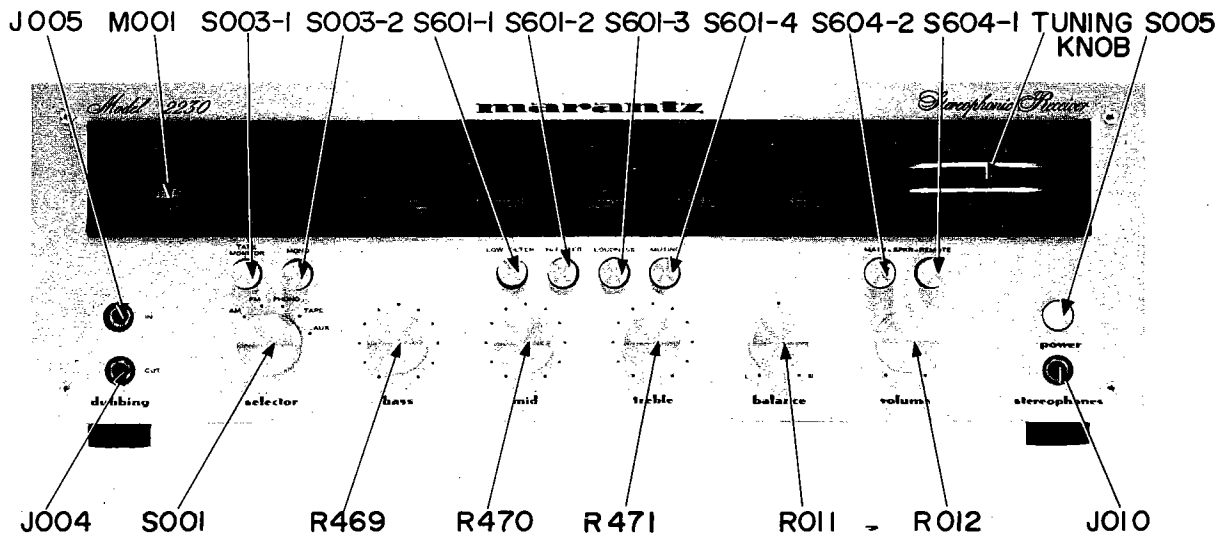

Figure 4. Front Panel Adjustment and Component Locations

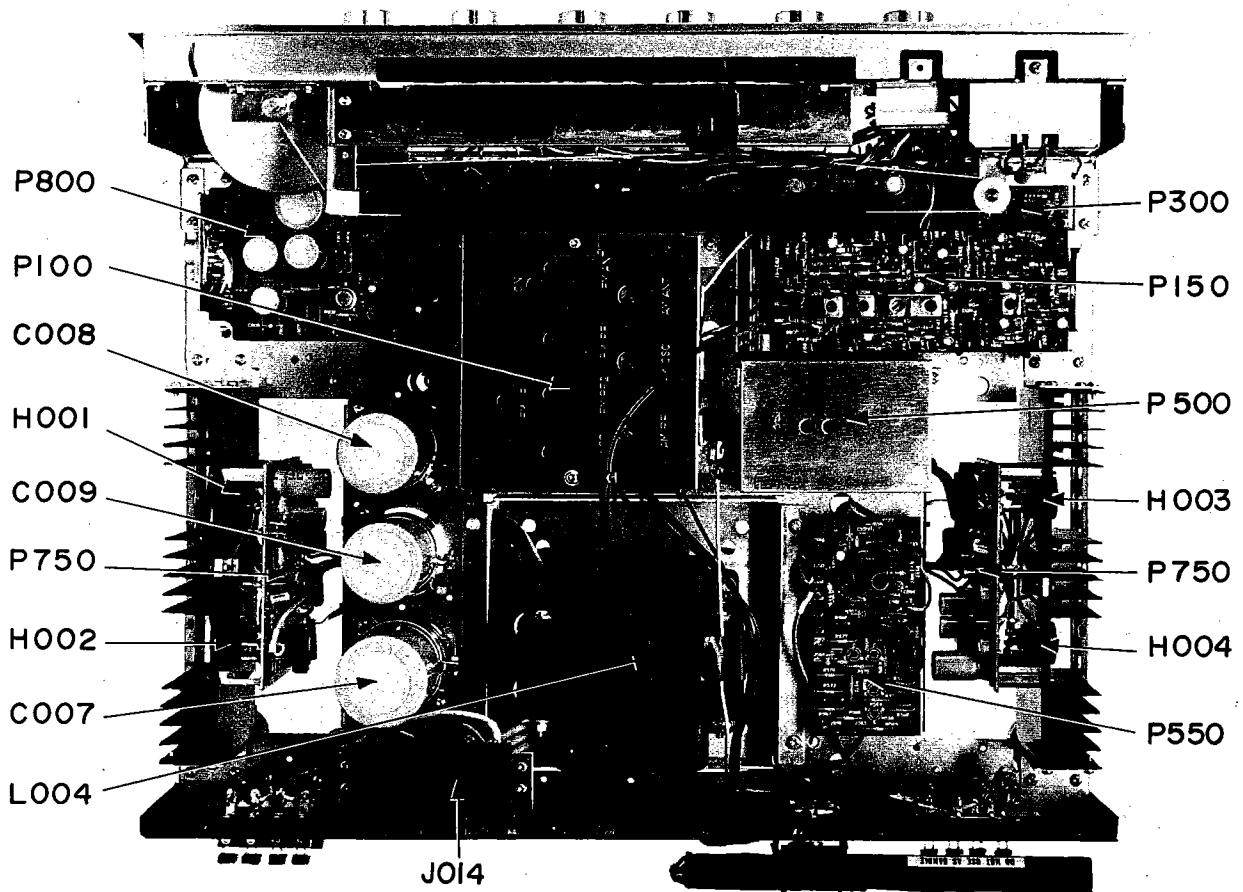

Figure 5. Main Chassis Component Locations (Top View)

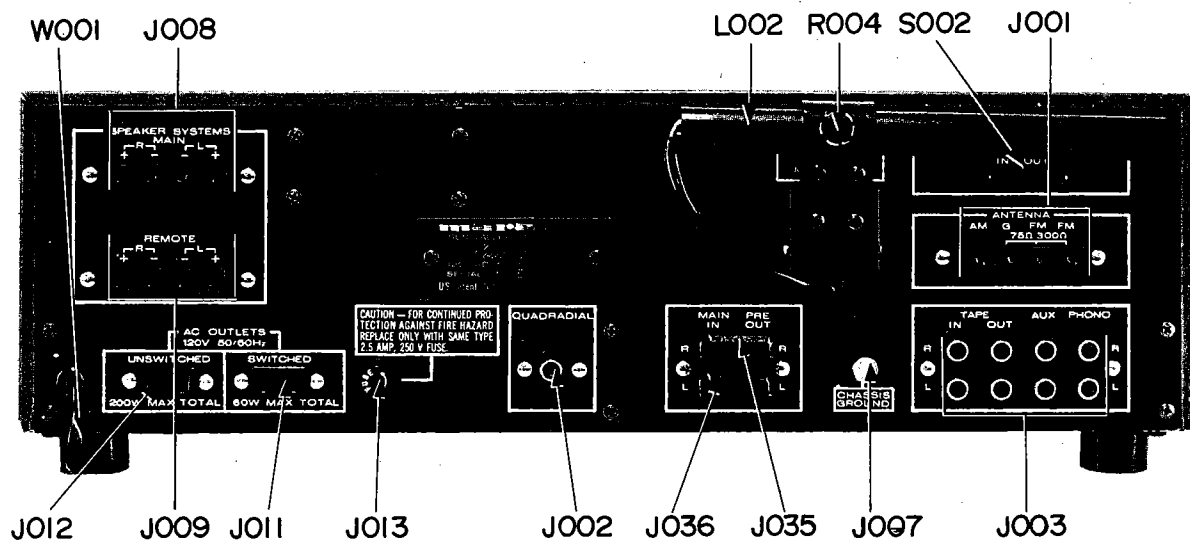

Figure 6. Rear Panel Adjustment and Component Locations

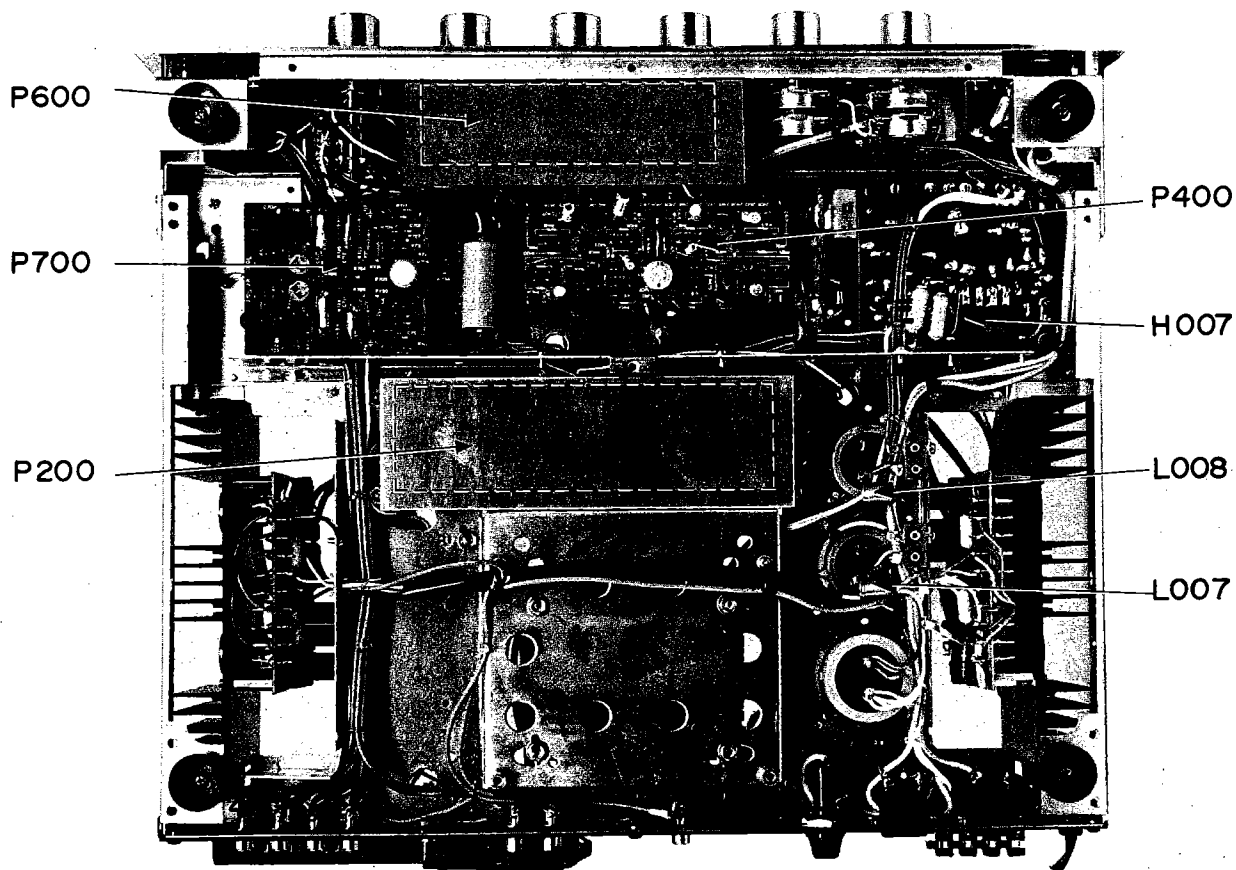

Figure 7. Main Chassis Component Locations (Bottom View)

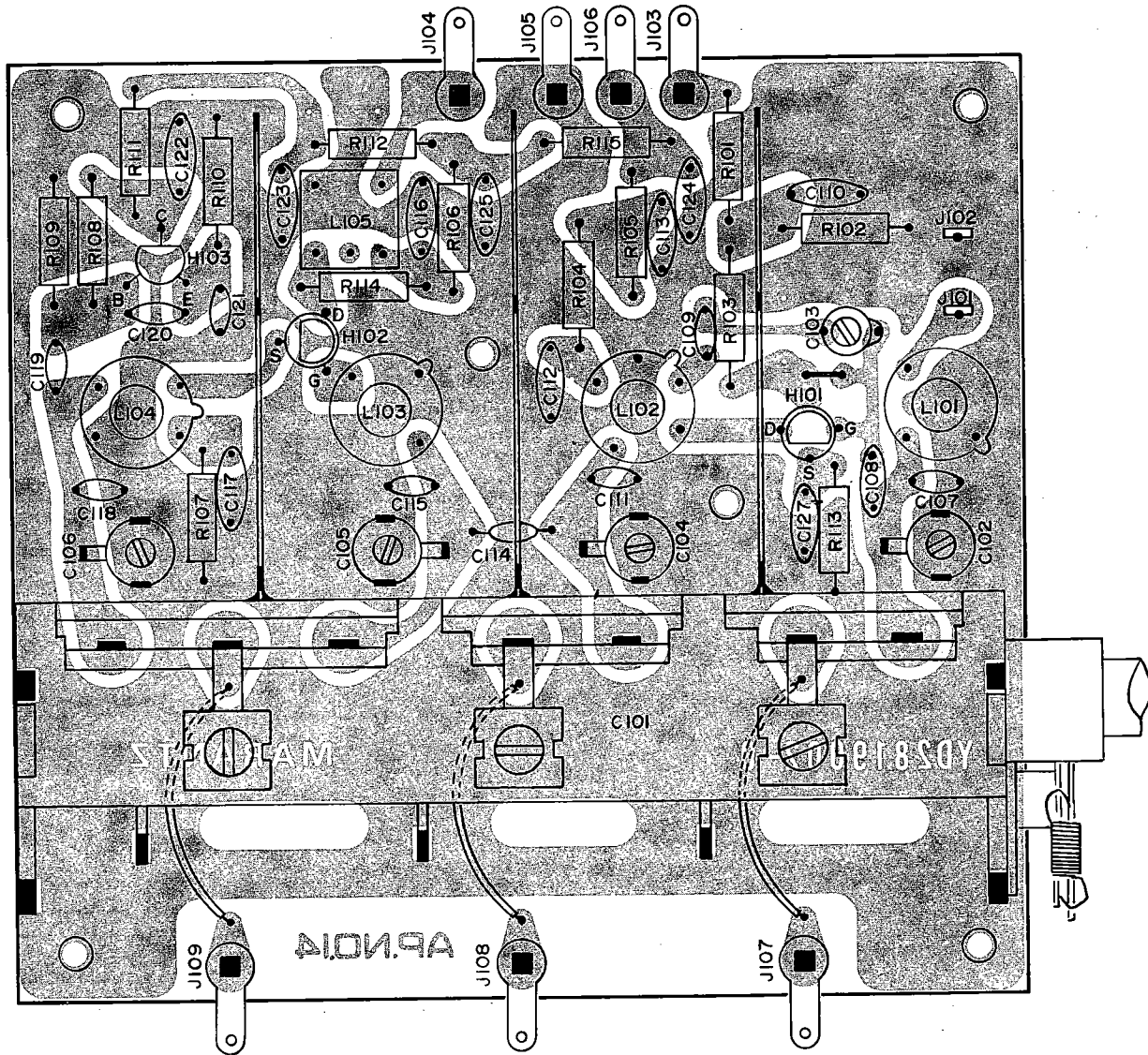

Figure 8. FM Front End Assembly P100 Component Locations

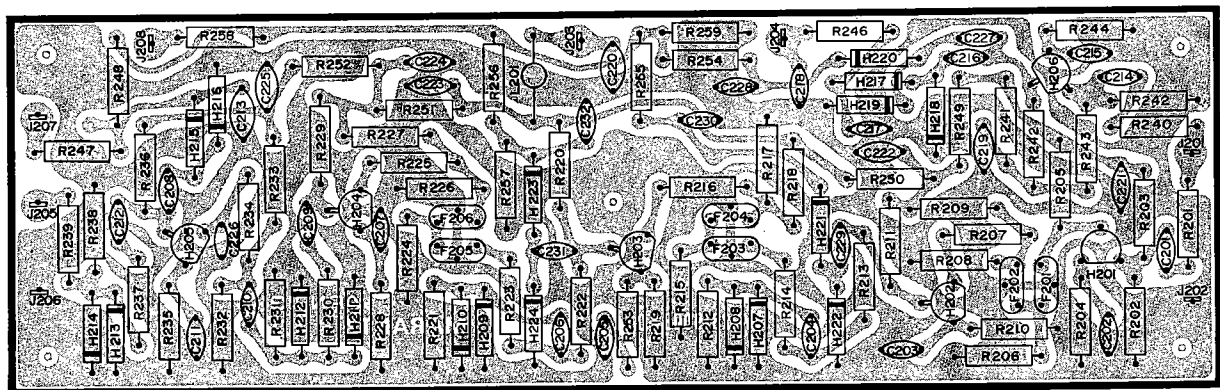

Figure 9. FM IF Amplifier Assembly P200 Component Locations

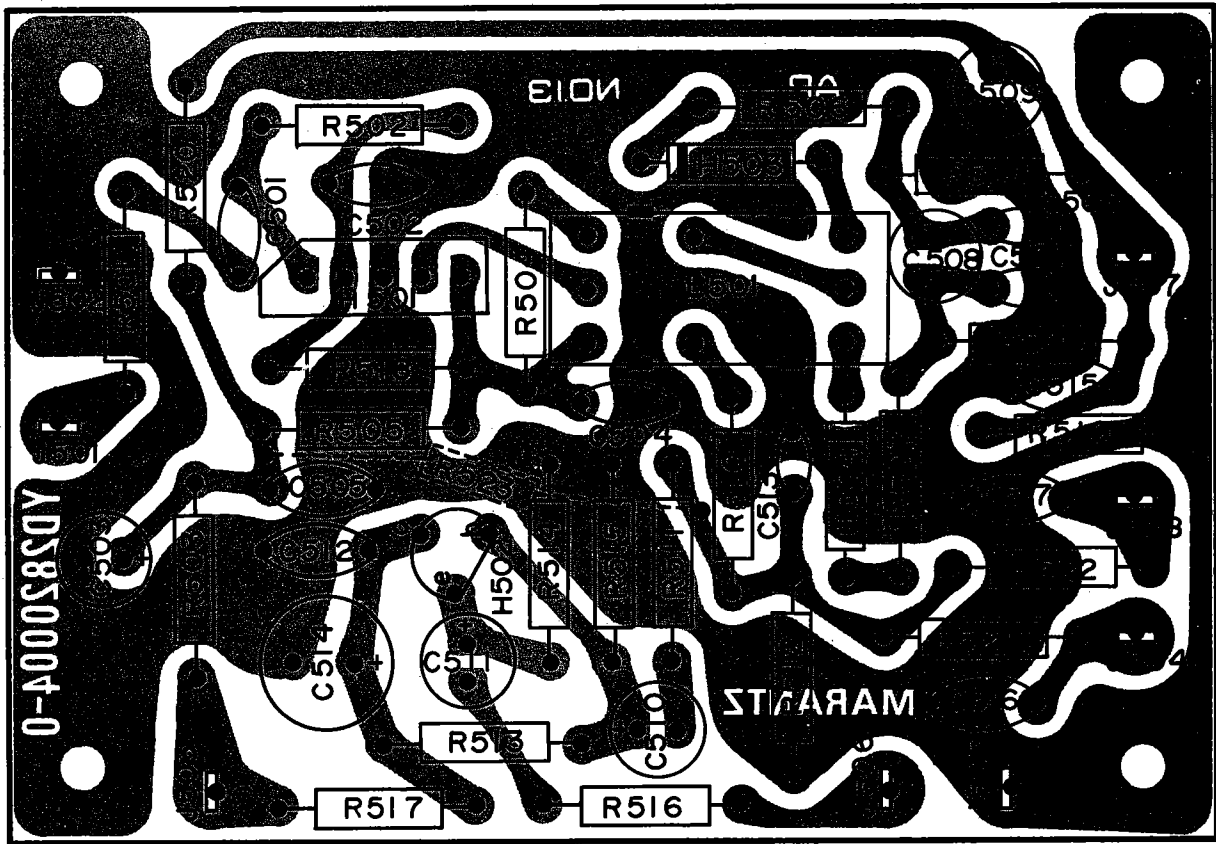

Figure 10. FM Detector Assembly P500 Component Locations

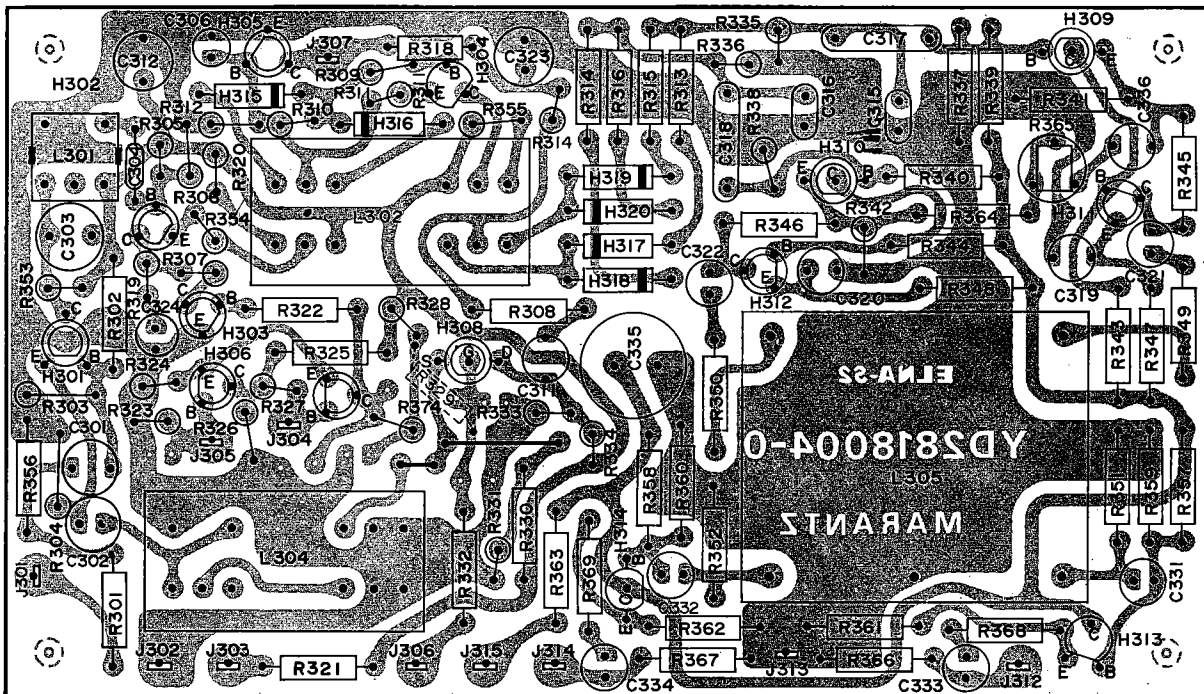

Figure 11. MPX Stereo Decoding Amplifier Assembly P300 Component Locations

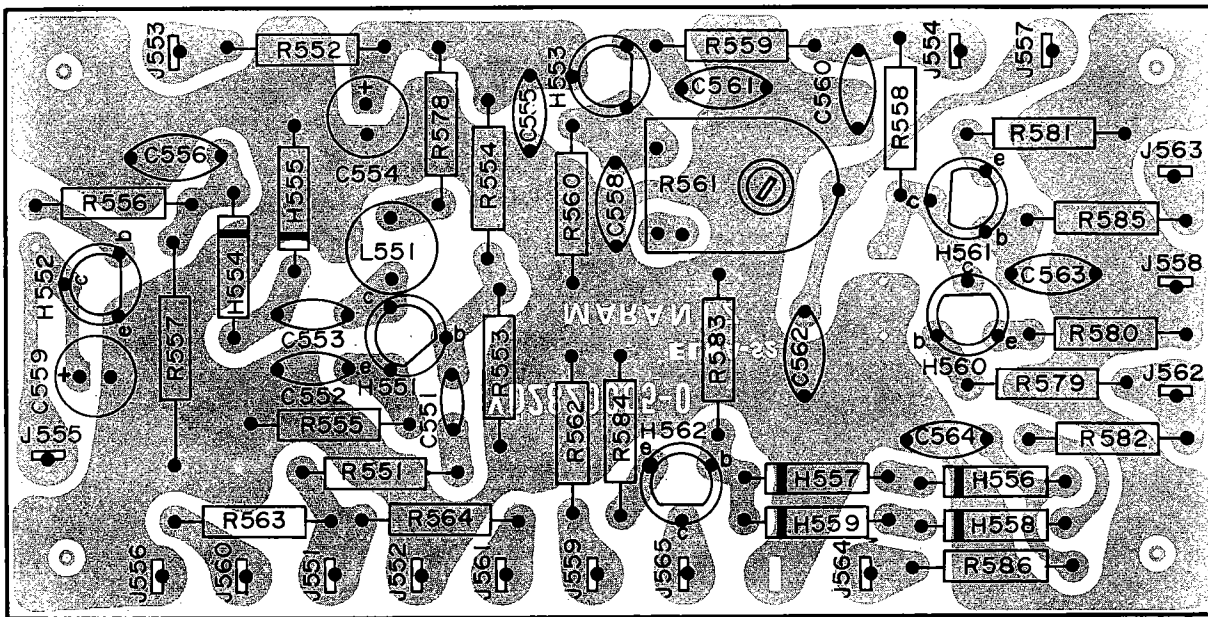

Figure 12. Muting Control Amplifier Assembly P550 Component Locations

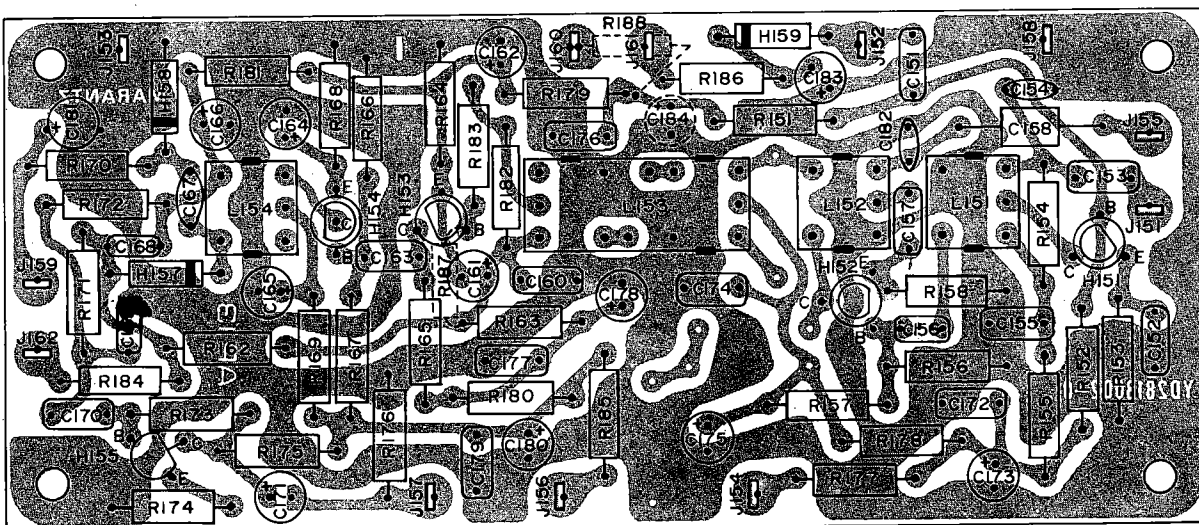

Figure 13. AM Tuner Unit Assembly P150 Component Locations

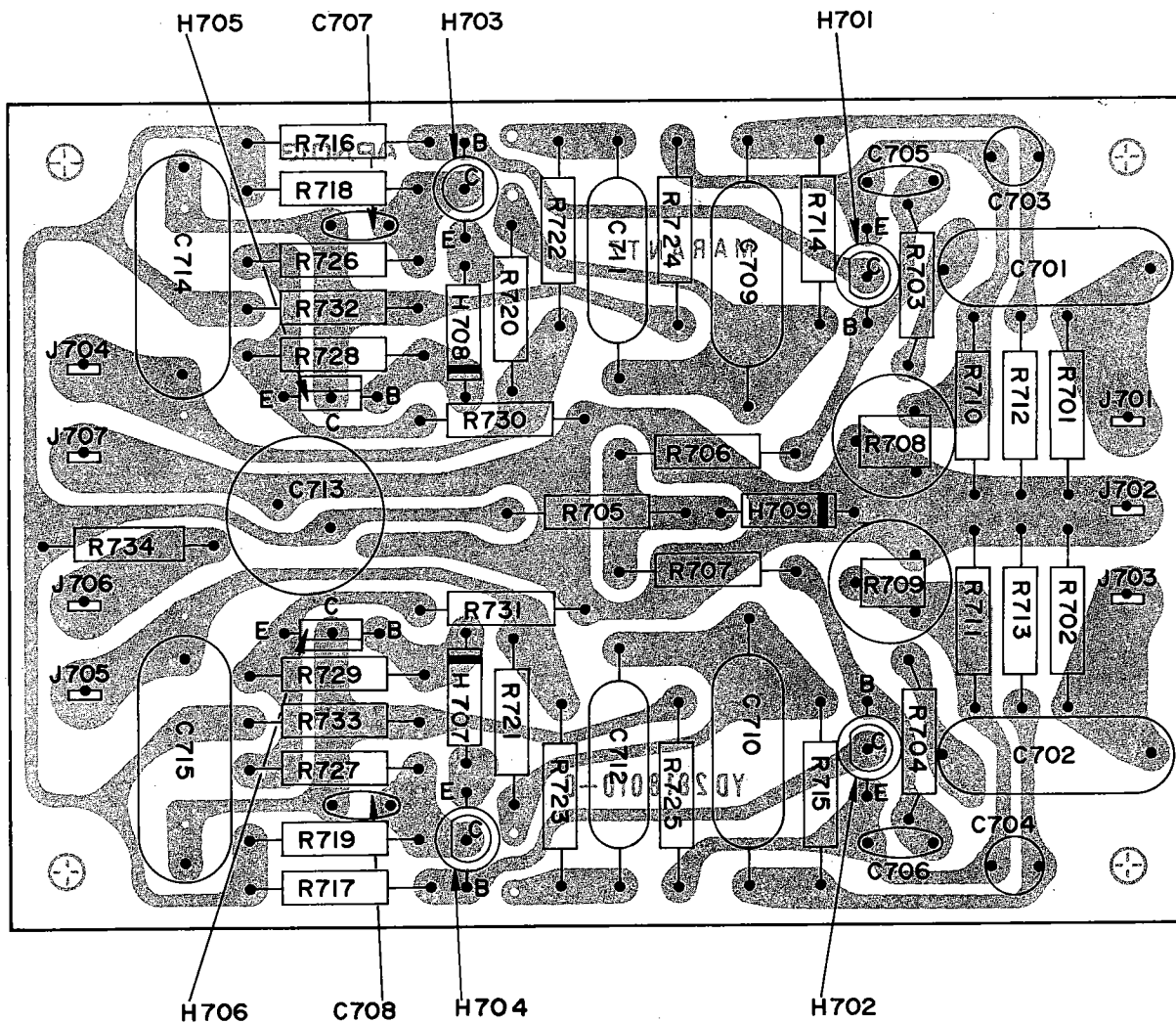

Figure 14. Phono Amplifier Assembly P700 Component Locations

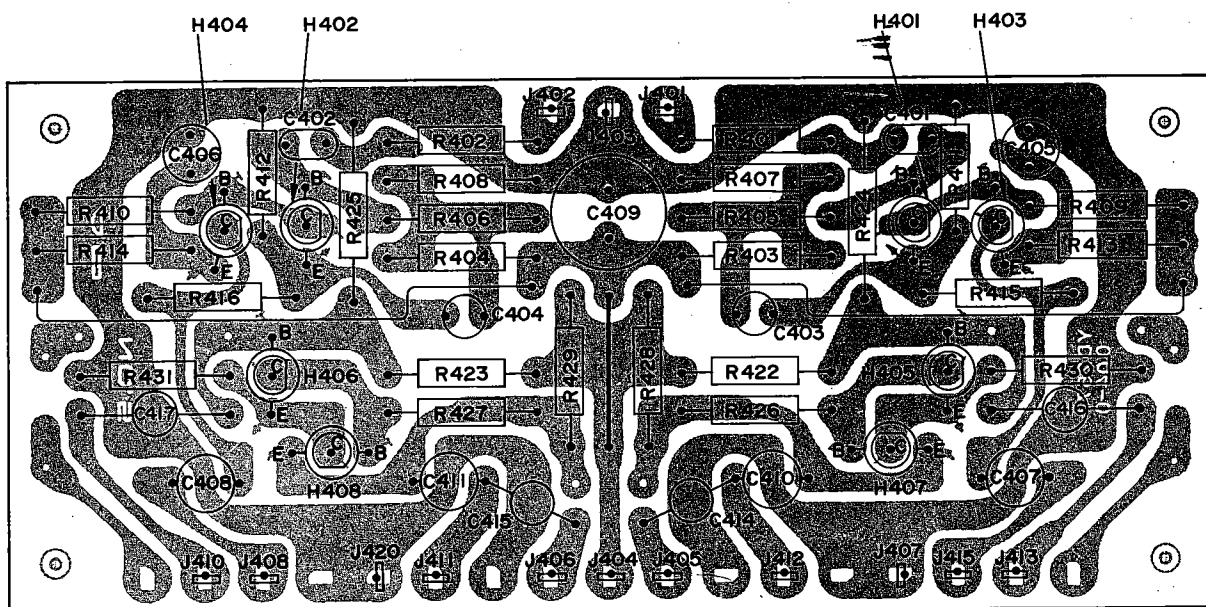

Figure 15. Tone Amplifier Assembly P400 Component Locations

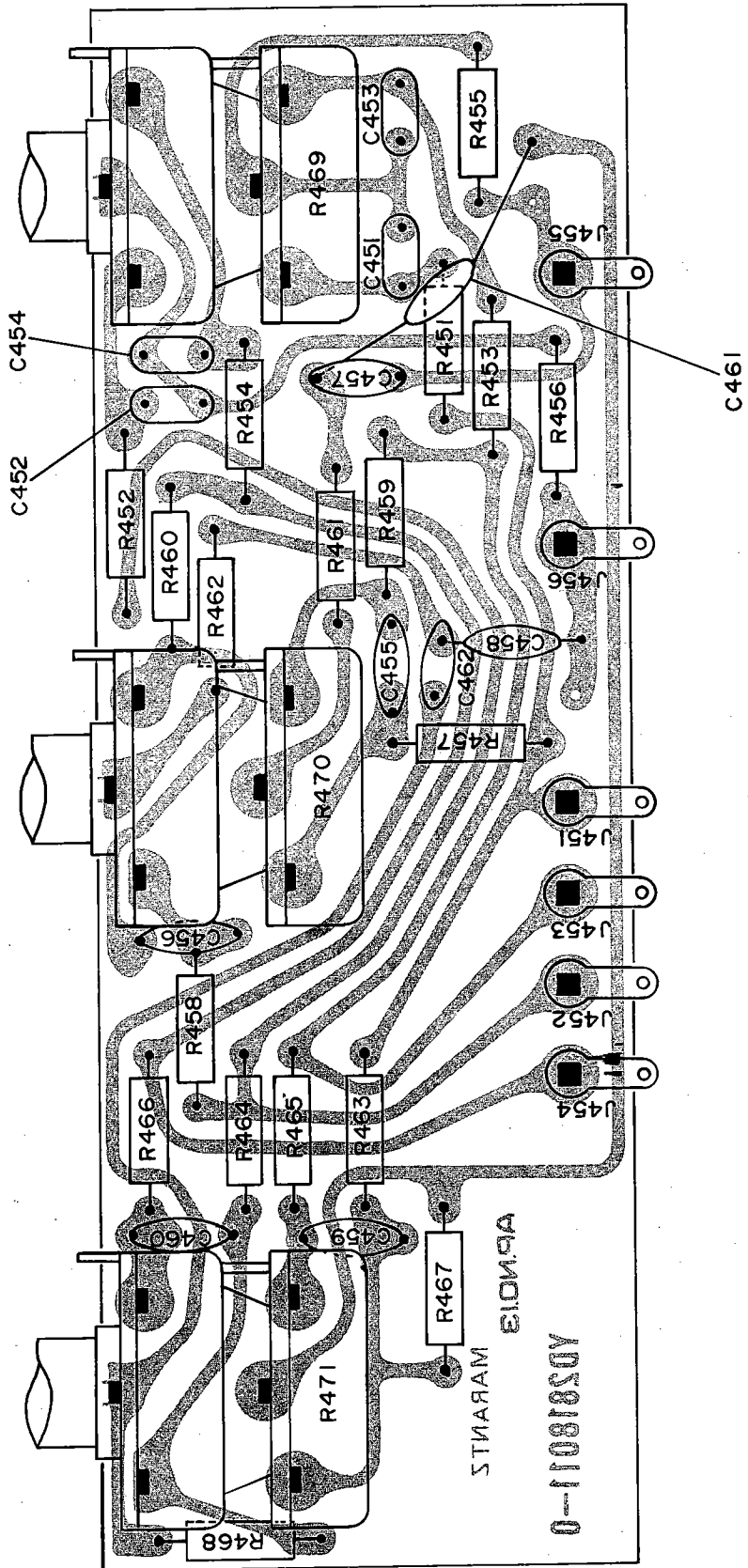

Figure 16. Tone Control Unit Assembly P450 Component Locations

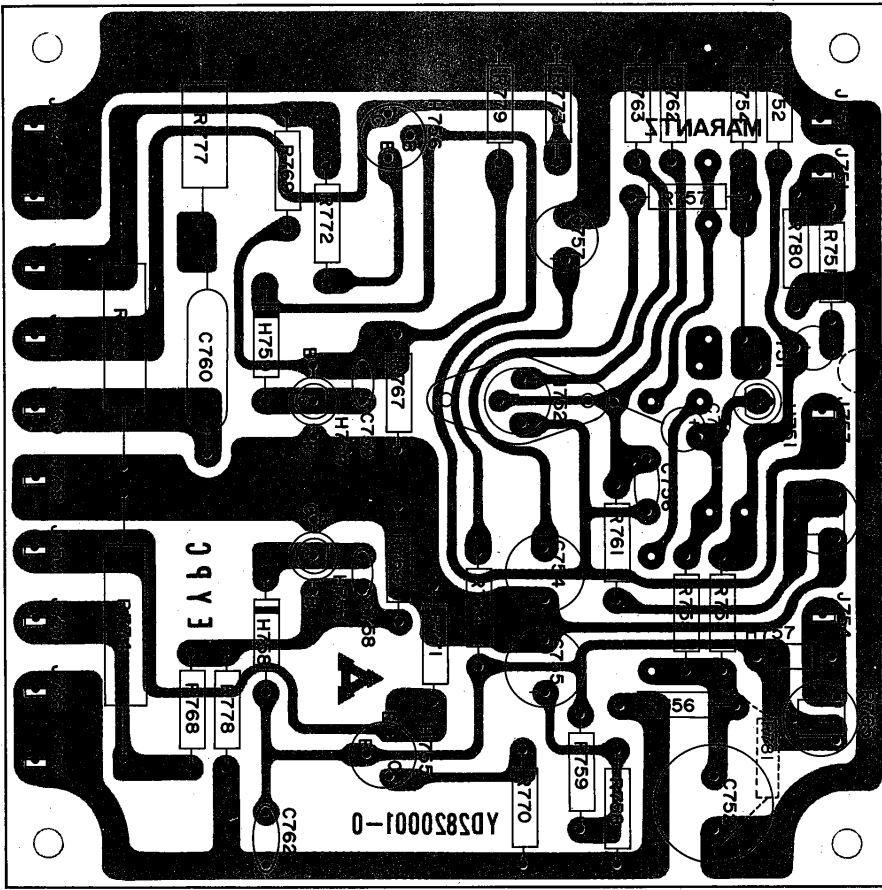

Figure 17. Power Amplifier Assembly P750 Component Locations

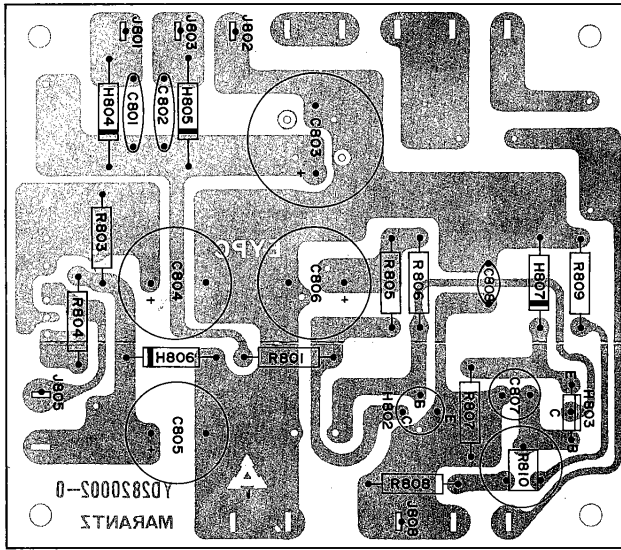
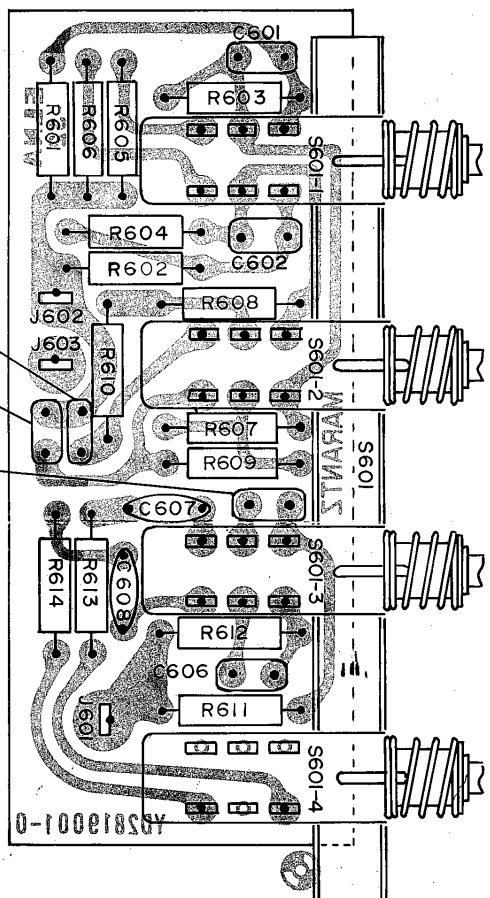

Figure 18. Regulated Power Supply Assembly P800 Component Locations



SPECIFICATIONS

Audio Circuits:

Rated continuous (RMS) power output per channel, both channels operating simultaneously	30 Watts at 4 and 8 ohms 20 Watts at 16 ohms
Comparable Total Music Power (IHF)	90 Watts at 8 ohms
High-level hum and noise (ref. 30W at 8 ohms)	-83 dB
Phono hum and noise	1.5 μ V equivalent input
Dynamic range (phono input to tape recording output)	96 dB
I. M. Distortion (SMPTE), at rated power	0.5%
Distortion decreases as output is lowered	
Total Harmonic Distortion, at rated power	0.5% Maximum
Distortion decreases as output is lowered	
Power Bandwidth (IHF) for 0.5% THD	15 Hz to 50,000 Hz
Damping Factor (ref. 8 ohms)	Greater than 45
Frequency Response	
Through phono	\pm 1 dB
Input Sensitivity (for 30W at 8 ohms)	
High-level	180 mV
Phono (1,000 Hz)	1.8 mV
Input Impedance	
High-level	100,000 ohms
Phono	47,000 ohms
Channel Separation 20 Hz to 20,000 Hz	35 dB Minimum

FM Sections:

IHF Usable Sensitivity	2.3 μ V
Selectivity	60 dB
Noise Quieting	-55 dB at 5 μ V -60 dB at 10 μ V -65 dB at 50 μ V
Total Harmonic Distortion, 400 Hz, 100% Mod.	(Mono) 0.3% (Stereo) 0.4%
Frequency Response (ref. 75 μ sec. de-emphasis)	\pm 1dB 50Hz to 15KHz
Stereo Separation	1,000 Hz 40 dB
Sub-Carrier (38 kHz) Suppression	60 dB

General:

Power Requirements	100/120/200/220/240V AC 50 to 60 Hz
At rated output, both channels operating	190 Watts
Idling Power (Volume Control at zero)	48 Watts
Dimensions	
Panel Width	17 ²¹ / ₆₄ Inches
Panel Height	5 ²⁵ / ₆₄ Inches
Depth	14 Inches
Weight	
Unit alone	28.6lbs
Packed for shipment	38.6lbs

* These specifications and exterior designs may be changed for improvement without advance notice.

REF. DESIG.	MARANTZ PART NO.	DESCRIPTION
R015-R016	RJ1047002	Carbon, 47Ω, ±10%, 2W
R017	GT0522501	Carbon, 2.2MΩ, ±10%, 1W
R018	GS1015105	Carbon, 150Ω, ±10%, 5W
R019	RC1018012	Solid, 18Ω, ±10%, 1/2W
R020	RT1082214	Carbon, 8.2KΩ, ±10%, 1/4W
R021-R022	RC1002212	Solid, 2.2Ω, ±10%, 1/2W
CAPACITORS		
C001	EA3360109	Elect.,
C002-C004	DK1710301	Ceramic, 0.01μF, ±50V, YY
C005-C006	DO0720350	Oil Paper, 0.02μF, ±20%, 600VDC
C007	EC4780801	Elect., 4700μF, 80V
C008-C009	EC2280631	Elect., 2200μF, 63V
C010	DO0733380	Oil Paper, 0.033μF, ±20%, 800VAC
C011	ED2270501	Elect., 220μF, 50V
C012	DK1840301	Ceramic, 0.04μF, 50V
SEMICONDUCTORS		
H001	HK021719A	Transistor, 2SD217 L.M.
H003	HK021719A	Transistor, 2SD217 L.M.
H005-H006	HV0000212	Varistor, SU-3A
H007	HD2000510	Diode, 5B2
H009	HV0000110	Diode, RV
TRANSFORMERS		
L001	LB3007526	Balun Coil, FM300Ω-75Ω
L002	LF1120023	Ant. Coil,
L003	LC1302001	Choke Coil 3μH
L004	TS1960107	Power Transf.
L005-L006	LC1302001	Choke Coil 3μH
MISCELLANEOUS		
M001	IM1104204	FM/AM Signal Meter
M002-M003	IN1006301	Stereo Lamp, 6.3V 0.04A
M004-M008	IN1006301	Function Illumination Lamp, 6.3V 0.04A
M009	IN1008018	Dial Pointer Illumination Lamp, 8V 0.06A
M010-M014	IN1008007	Dial Illumination Lamp, 8V 0.2A
M015	IN1008007	Meter Illumination Lamp, 8V 0.2A
S001	SR0805016	Function Switch
S002	SS0202017	FM Ant. Attenuator Switch
S003	SP0402003	Tape Monitor/Mono Push Switch
S004	SP0402004	Main/Remote Speaker Switch
S005	SP0201010	Power Switch
J004	YJ0100065	Dubbing Out Jack
J005	YJ0100055	Dubbing In Jack
J007	YT0101003	Ground Terminal
J010	YJ0100055	Headphone Jack
J013	YJ0800012	Fuse Holder Socket
J014	YL0106004	AC Voltage Select. Terminal
J015-J018	YJ0500013	Power Transistor Socket

REF. DESIG.	MARANTZ PART NO.	DESCRIPTION
J021	YL0107001	7P Terminal
J027-J031	YJ0800013	Dial Illumination Socket
J032	YJ0800013	Meter Illumination Socket
J033	YL0107001	7P Terminal
J034	YL0104001	4P Terminal
J035-J036	YP1000097	Pre Out/Main In Plug
J037	YJ0500017	Transistor Socket
J038	YL0102003	Dial Pointer Lamp Terminal
J039-J044	YP1000094	Plug
J045	YL0102003	Terminal
J046-J047	YL0102003	Terminal
F001	FS1025002	Fuse UL 2.5A
W001	YC0240010	AC Cord
W002-W003	YB0007001	Connective Cord for Conversion
W004	YB0027001	Connective Cord for Conversion
W005-W006	YX2820001	AC Line Wire Material

REF. DESIG.	MARANTZ PART NO.	DESCRIPTION
H707-H708 H709	HD2000206 HV0000206	Diode, 1S1212 Varistor, VD1212
J701-J707	YP1000091	MISCELLANEOUS Plug
P750	YD2820001 (ZZ2820001)	P.C. Board x 2 P.C. Board Assembly
		RESISTORS
R751	RT1010214	Carbon, 1K Ω , $\pm 10\%$, 1/4W x 2
R752	RN1056314	Carbon, 56K Ω , $\pm 10\%$, 1/4W x 2
R753	RN1047414	Carbon, 470K Ω , $\pm 10\%$, 1/4W x 2
R754	GT0515112	Carbon, 150 Ω , $\pm 5\%$, 1/2W x 2
R755	RT1039214	Carbon, 3.9K Ω , $\pm 10\%$, 1/4W x 2
R756	RC1018312	Solid, 18K Ω , $\pm 10\%$, 1/2W x 2
R757	GT0522212	Carbon, 2.2K Ω , $\pm 5\%$, 1/2W x 2
R758	RC1022212	Solid, 2.2K Ω , $\pm 10\%$, 1/2W x 2
R759	RC1033212	Solid, 3.3K Ω , $\pm 10\%$, 1/2W x 2
R760	RA0104012	Trimmer, 100K Ω , $\pm 25\%$, B x 2
R761	RN1015414	Carbon, 150K Ω , $\pm 10\%$, 1/4W x 2
R762	RN1010314	Carbon, 10K Ω , $\pm 10\%$, 1/4W x 2
R763	RC1033012	Solid, 33 Ω , $\pm 10\%$, 1/2W x 2
R764	RC1082212	Solid, 8.2K Ω , $\pm 10\%$, 1/2W x 2
R765	RA0501005	Trimmer, 470 Ω , $\pm 25\%$, B x 2
R766-R767	RC1047112	Solid, 470 Ω , $\pm 10\%$, 1/2W x 2
R768-R769	RC1039112	Solid, 390 Ω , $\pm 10\%$, 1/2W x 2
R770	RC1010012	Solid, 10 Ω , $\pm 10\%$, 1/2W x 2
R771	RC1022112	Solid, 220 Ω , $\pm 10\%$, 1/2W x 2
R772	RC1010012	Solid, 10 Ω , $\pm 10\%$, 1/2W x 2
R773	RC1022112	Solid, 220 Ω , $\pm 10\%$, 1/2W x 2
R774-R775	GW1024202	Wire Wound 0.24 Ω , x 2
R777	GT0510002	Carbon, 10 Ω , $\pm 5\%$, 2W x 2
R778-R779	RC1027312	Solid, 27K Ω , $\pm 10\%$, 1/2W x 2
R780	RN1022414	Carbon, 220K Ω , $\pm 10\%$, 1/4W x 2
R781	RC1082212	Solid, 8.2K Ω , $\pm 10\%$, 1/2W x 2
		CAPACITORS
C751	EV4740251	Elect., 0.47 μ F, $\pm 20\%$, 25V x 2
C752	EA1070509	Elect., 100 μ F, 50V x 2
C753	EA1050509	Elect., 0.1 μ F, 50V x 2
C754-C755	EA4760509	Elect., 47 μ F, 50V x 2
C756	DD1650001	Ceramic, 50pF, $\pm 10\%$, 50V x 2
C757	EA2260359	Elect., 22 μ F, 35V x 2
C758-C759	DD1650001	Ceramic, 50pF, $\pm 10\%$, 50V x 2
C760	DF1710452	Mylar, 0.1 μ F, 200V x 2
C761	DD1610101	Ceramic, 100pF, $\pm 10\%$ x 2
C762	DF3610152	Mylar, 100pF $\pm 10\%$ x 2
		SEMICONDUCTORS
H751	HT309452A	Transistor, 2SC945 Q, R x 2
H752	HT309602A	Transistor, 2SC960 M, L x 2
H753	HT303711B	Transistor, 2SC371 Y x 2

REF. DESIG.	MARANTZ PART NO.	DESCRIPTION
H754	HT105621B	Transistor, 2SA562 Y x 2
H755	HK060619A	Transistor, 2SA606 (N.M.L.) x 2
H757	HV0000705	Varistor, 2SC959 (N.M.L.) x 2
H758-H759	HD1000105	Diode, S3016R x 2
		MISCELLANEOUS
J751-J764	YP1000091	Plug x 2
P800	YD2820002 (ZZ2820002)	P.C. Board P.C. Board Assembly
		RESISTORS
R801	RC1010012	Solid, 10 Ω , $\pm 10\%$, 1/2W
R803	RC1033212	Solid, 3.3K Ω , $\pm 10\%$, 1/2W
R804	RC1010012	Solid, 10 Ω , $\pm 10\%$, 1/2W
R805	RT1047214	Carbon, 4.7K Ω , $\pm 10\%$, 1/4W
R806	RT1015214	Carbon, 1.5K Ω , $\pm 10\%$, 1/4W
R807	RC1039212	Solid, 3.9K Ω , $\pm 10\%$, 1/2W
R808	RT1027314	Carbon, 27K Ω , $\pm 10\%$, 1/4W
R809	RT1056214	Carbon, 5.6K Ω , $\pm 10\%$, 1/4W
R810	RA0502013	Trimmer, 4.7K Ω , $\pm 25\%$, B
		CAPACITORS
C801-C802	DK1810351	Ceramic, 0.01 μ F, $\pm 100\%$, 500V
C803	EB4770631	Elect., 470 μ F, $\pm 10\%$, 63V
C804	EA3370509	Elect., 330 μ F, 50V
C805	EA4770169	Elect., 470 μ F, 16V
C806	EA3370509	Elect., 330 μ F, 50V
C807	EA3350509	Elect., 3.3 μ F, 50V
		SEMICONDUCTORS
H801	HT403154A	Transistor, 2SD315 C.D.E.F.
H802	HT309965A	Transistor, 2SC696 A.B.D.E.H
H803	HT312132A	Transistor, 2SC1213 B.C
H804-H805	HD2000413	Diode, S1B-01-02
H806	HD3002109	Diode, BZ-140
H807	HD3002309	Diode, WZ-071
		MISCELLANEOUS
J801-J803	YP1000091	Plug
J805	YP1000091	Plug
J808	YP1000091	Plug
		RESISTORS
R001-R002	RC1068012	Solid, 68 Ω , $\pm 10\%$, 1/2W
R003	RC1008212	Solid, 8.2 Ω , $\pm 10\%$, 1/2W
R004	RK0254002	Variable, 250K Ω , B
R005	RC1020012	Solid, 20 Ω , $\pm 10\%$, 1/2W
R006	RC1010212	Solid, 1K Ω , $\pm 10\%$, 1/2W
R007-R008	RT1047214	Carbon, 4.7K Ω , $\pm 10\%$, 1/4W
R009-R010	RT1010214	Carbon, 1K Ω , $\pm 10\%$, 1/4W
R011	RM0254020	Variable, 250K Ω MN
R012	RM0254021	Variable, 250K Ω A
R013-R014	RJ1010102	Carbon, 100 Ω , $\pm 10\%$, 2W

REF. DESIG.	MARANTZ PART NO.	DESCRIPTION
R422-R423	RN1022514	Carbon, 2.2M Ω , \pm 10%, 1/4W
R424-R425	RN1068314	Carbon, 68K Ω , \pm 10%, 1/4W
R426-R429	RN1010314	Carbon, 10K Ω , \pm 10%, 1/4W
R430-R431	RT0522114	Carbon, 220 Ω , \pm 5%, 1/4W
CAPACITORS		
C401-C402	DF1722402	Mylar, 0.22 μ F, \pm 20%, 50V
C403-C404	EV1050251	Elect., 1 μ F, \pm 40%, 25V
C405-C406	EA1060359	Elect., 10 μ F, 35V
C408	EV3350251	Elect., 3.3 μ F, \pm 40%, 25V
C409	EA1070359	Elect., 100 μ F, 35V
C411	EV3350251	Elect., 3.3 μ F, \pm 40%, 25V
C414-C415	EV1050351	Elect., 1 μ F, \pm 40%, 35V
C416-C417	EV4740251	Elect., 0.47 μ F, \pm 40%, 25V
SEMICONDUCTORS		
H401-H402	HT310002A	Transistor, 2SC1000 (Gr or Bl)
H403-H404	HT104932A	Transistor, 2SA493 (Y or Gr)
H405-H406	HT310002A	Transistor, 2SC1000 (Gr or Bl)
H407-H408	HT104932A	Transistor, 2SA493 (Y or Gr)
MISCELLANEOUS		
J401-J403	YP1000036	Plug
J405-J407	YP1000036	Plug
J420	YP1000036	Plug
P450	YD2818011 (ZZ2818011)	P.C. Board P.C. Board Assembly
RESISTORS		
R451-R454	RT0510314	Carbon, 10K Ω , \pm 5%, 1/4W
R455-R456	RT0527314	Carbon, 27K Ω , \pm 5%, 1/4W
R457-R460	RT0556214	Carbon, 5.6K Ω , \pm 5%, 1/4W
R461-R462	RT0527314	Carbon, 27K Ω , \pm 5%, 1/4W
R463-R466	RT0556214	Carbon, 5.6K Ω , \pm 5%, 1/4W
R467-R468	RT0515414	Carbon, 150K Ω , \pm 5%, 1/4W
R469-R471	RM0104005	Variable, 100K Ω (B)
CAPACITORS		
C451-C454	DF1622301	Mylar, 0.022 μ F, \pm 10%, 50V
C455-C456	DK1668201	Ceramic, 0.0068 μ F, \pm 10%, 50V
C457-C458	DK1610301	Ceramic, 0.01 μ F, \pm 10%, 50V
C459-C460	DD1510101	Ceramic, 100pF, \pm 5%, 50V
C461-C462	DK1622201	Ceramic, 0.0022 μ F, \pm 10%, 50V
MISCELLANEOUS		
J451-J456	57219520W	Plug
P600	YD2819001	P.C. Board P.C. Board Assembly

REF. DESIG.	MARANTZ PART NO.	DESCRIPTION
RESISTORS		
R601-R602	RT1022414	Carbon, 220K Ω , \pm 10%, 1/4W
R603-R604	RT1010514	Carbon, 1M Ω , \pm 10%, 1/4W
R605-R606	RT0510414	Carbon, 100K Ω , \pm 5%, 1/4W
R607-R608	RT0547214	Carbon, 4.7K Ω , \pm 5%, 1/4W
R609-R610	RT1022514	Carbon, 2.2M Ω , \pm 10%, 1/4W
R611-R612	RT0510314	Carbon, 10K Ω , \pm 5%, 1/4W
R613-R614	RT1010414	Carbon, 100K Ω , \pm 10%, 1/4W
CAPACITORS		
C601-C602	DF1647301	Mylar, 0.047 μ F, \pm 10%, 50V
C603-C604	DF1668201	Mylar, 0.0068 μ F, \pm 10%, 50V
C605-C606	DF1733301	Mylar, 0.033 μ F, \pm 20%, 50V
C607-C608	DD1510101	Ceramic, 100pF, \pm 5%, 50V
MISCELLANEOUS		
J601-J603	YP1000094	Plug
S601	SP0204003	Push Switch,
P700	YD2818010 (ZZ2818010)	P.C. Board P.C. Board Assembly
RESISTORS		
R701-R702	RT0547314	Carbon, 47K Ω , \pm 5%, 1/4W
R703-R704	RT1047114	Carbon, 470 Ω , \pm 10%, 1/4W
R705	RN1033314	Carbon, 33K Ω , \pm 10%, 1/4W
R706-R707	RN1010514	Carbon, 1M Ω , \pm 10%, 1/4W
R708-R709	RA0104012	Trimmer, 100K Ω (B)
R710-R711	RN1027314	Carbon, 27K Ω , \pm 10%, 1/4W
R712-R713	GT0562112	Carbon, 620 Ω , \pm 5%, 1/2W
R714-R715	RT0522514	Carbon, 2.2M Ω , \pm 5%, 1/4W
R716-R717	RN1022514	Carbon, 2.2M Ω , \pm 10%, 1/4W
R718-R719	RN1027414	Carbon, 270K Ω , \pm 10%, 1/4W
R720-R721	GT0547312	Carbon, 47K Ω , \pm 5%, 1/2W
R722-R723	GT0522212	Carbon, 2.2K Ω , \pm 5%, 1/2W
R724-R725	GT0568412	Carbon, 680K Ω , \pm 5%, 1/2W
R726-R727	RN1010414	Carbon, 100K Ω , \pm 10%, 1/4W
R728-R729	RN1047314	Carbon, 47K Ω , \pm 10%, 1/4W
R730-R731	RT1047014	Carbon, 47 Ω , \pm 10%, 1/4W
R732-R733	RN1033214	Carbon, 3.3K Ω , \pm 10%, 1/4W
R734	RT1010114	Carbon, 100 Ω , \pm 10%, 1/4W
CAPACITORS		
C701-C702	DF1747401	Mylar, 0.47 μ F, \pm 20%, 50V
C703-C704	EV2260061	Elect., 22 μ F, \pm 40%, 6.3V
C705-C706	DD1540004	Ceramic, 40pF, \pm 5%, 50V
C707-C708	DD1104001	Ceramic, 4pF, \pm 0.5pF, 50V
C709-C710	DF6456201	Mylar, 5600pF, \pm 20%, 50V
C711-C712	DF6416201	Mylar, 1650pF, \pm 20%, 50V
C713	EA1070509	Elect., 100 μ F, 50V
C714-C715	DF1747401	Mylar, 0.047 μ F, \pm 20%, 50V
SEMICONDUCTORS		
H701-H704	HT310002A	Transistor, 2SC1000 Gr or Bl
H705-H706	HT304580R	Transistor, 2SC458 LG A (B)

REF. DESIG.	MARANTZ PART NO.	DESCRIPTION		
R505	RT1020114	Carbon,	100Ω, ±10%,	1/4W
R506-R507	RT0582114	Carbon,	820Ω, ±5%,	1/4W
R508-R509	RT0568214	Carbon,	6.8KΩ, ±5%,	1/4W
R510	RT1010114	Carbon,	100Ω, ±10%,	1/4W
R511	RT1056214	Carbon,	2.7KΩ, ±10%,	1/4W
R512	RT1018314	Carbon,	18KΩ, ±10%,	1/4W
R513	RN1018414	Carbon,	180KΩ, ±10%,	1/4W
R514	RT1022214	Carbon,	2.2KΩ, ±10%,	1/4W
R515	RN1010414	Carbon,	100KΩ, ±10%,	1/4W
R516-R517	RT1010114	Carbon,	100Ω, ±10%,	1/4W
R518	RT1039214	Carbon,	27KΩ, ±10%,	1/4W
R519	RT1018314	Carbon,	18KΩ, ±10%,	1/4W
R520	RT1056414	Carbon,	560KΩ, ±10%,	1/4W
R521-R522	RT1010414	Carbon,	100KΩ, ±10%,	1/4W
R523	RT1056414	Carbon,	560KΩ, ±10%,	1/4W
CAPACITORS				
C501-C502	DK1710301	Ceramic,	0.01μF, ±20%,	YY
C503	EA1060169	Elect.,	10μF, 16V	
C504	DK1710301	Ceramic,	0.01μF, ±20%,	YY
C505	DK1840302	Ceramic,	0.04μF, +100% - 0%	
C506-C507	DD1620101	Ceramic,	200pF, ±10%,	SL
C508	EA1060169	Elect.,	10μF, 16V	
C509	EA4750359	Elect.,	4.7μF, 35V	
C510	EA1050509	Elect.,	1μF, 50V	
C511	EA1060169	Elect.,	10μF, 16V	
C512	DK1840302	Ceramic,	0.04μF, +100% - 0%	
C513	DD1620101	Ceramic,	200pF, ±10%	
C514	EA1070169	Elect.,	100μF, 16V	
C515-C517	DK1840302	Ceramic,	0.04μF, +100% - 0%	
SEMICONDUCTORS				
H501	HC1000105	IC,	TA7060P	
H502	HT306441B	Transistor,	2SC644S	
H503-H504	HD1000105	Diode,	1N60	
MISCELLANEOUS				
J501-J508	YP1000094	Plug		
L501	LI10188010	IFT	FM Det.	
P550	YD2820005 (ZZ2820005)	P.C. Board P.C. Board Assembly		
RESISTORS				
R551	RT1056214	Carbon,	5.6KΩ, ±10%,	1/4W
R552	RT1010114	Carbon,	100Ω, ±10%,	1/4W
R553	RT1027314	Carbon,	27KΩ, ±10%,	1/4W
R554	RT1010414	Carbon,	100KΩ, ±10%,	1/4W
R555	RT1010214	Carbon,	1KΩ, ±10%,	1/4W
R556	RT1033314	Carbon,	33KΩ, ±10%,	1/4W
R557	RT1033314	Carbon,	33KΩ, ±10%,	1/4W

REF. DESIG.	MARANTZ PART NO.	DESCRIPTION		
R558	RT1015414	Carbon,	150KΩ, ±10%,	1/4W
R559	RT1033314	Carbon,	33KΩ, ±10%,	1/4W
R560	RT1033214	Carbon,	3.3KΩ, ±10%,	1/4W
R561	RA0103018	Trimmer,	10KΩ, B	
R562	RT1022414	Carbon,	220KΩ, ±10%,	1/4W
R563-R578	RT1010114	Carbon,	100Ω, ±10%,	1/4W
R579	RT1010414	Carbon,	100KΩ, ±10%,	1/4W
R580-R581	RT1010214	Carbon,	1KΩ, ±10%,	1/4W
R582	RT1010414	Carbon,	100KΩ, ±10%,	1/4W
R583	RT1015514	Carbon,	1.5MΩ, ±10%,	1/4W
R584	RT1010214	Carbon,	1KΩ, ±10%,	1/4W
R585	RT1010314	Carbon,	10KΩ, ±10%,	1/4W
R586	RT1010314	Carbon,	10KΩ, ±10%,	1/4W
CAPACITORS				
C551	DD1615001	Ceramic,	15pF, ±10%,	SL
C552	DF1668301	Mylar,	0.068μF, ±10%,	
C553	DF1740301	Mylar,	0.04μF, ±20%,	
C554	EA1060169	Elect.,	10μF, 16V	
C555	DK1840302	Ceramic,	0.04μF, +100% - 0%	
C556	DK1810402	Ceramic,	0.1μF, +100% - 0%	
C558	DK1810402	Ceramic,	0.1μF, +100% - 0%	
C559	EA4750359	Elect.,	4.7μF, 35V	
C561	DK1710301	Ceramic,	0.01μF, ±20%	
C562	DK1840301	Ceramic,	0.04μF, +100% - 0%	
C563-C564	DF1710402	Mylar,	0.1μF, ±20%	
SEMICONDUCTORS				
H551	HT307331C	Transistor,	2SC733 GR	
H552-H553	HT3057210	Transistor,	2SC372	
H554-H559	HD1000105	Diode,	1N60	
H560-H561	HT303720A	Transistor,	2SC372Y	
H562	HT307331D	Transistor,	2SC733 BL	
MISCELLANEOUS				
L551	LC2105001	Choke Coil,	1mH	
J551-J565	YP1000094	Plug		
P400	YD2577004 (ZZ2577004)	P.C. Board P.C. Board Assembly		
RESISTORS				
R401-R402	RT1039114	Carbon,	390Ω, ±10%,	1/4W
R403-R404	RN1015414	Carbon,	150KΩ, ±10%,	1/4W
R405-R406	RN1010414	Carbon,	100KΩ, ±10%,	1/4W
R407-R408	RN1022314	Carbon,	22KΩ, ±10%,	1/4W
R409-R410	RN1027314	Carbon,	27KΩ, ±10%,	1/4W
R411-R412	RT0520214	Carbon,	2KΩ, ±5%,	1/4W
R413-R414	RT1010214	Carbon,	1KΩ, ±10%,	1/4W
R415-R416	RT0510314	Carbon,	10KΩ, ±5%,	1/4W

REF. DESIG.	MARANTZ PART NO.	DESCRIPTION	REF. DESIG.	MARANTZ PART NO.	DESCRIPTION
L201	LC1682002	MISCELLANEOUS Choke Coil, 6.8 μ H, \pm 20%, 100mA	R359-R360	RN1022414	Carbon, 220K Ω , \pm 10%, 1/4W
F201-F206	FF1107003	Ceramic Filter, SFA 10.7 MHz	R361-R362	RT1047214	Carbon, 4.7K Ω , \pm 10%, 1/4W
J201-J208	YP1000094	Plug	R363	RT1018214	Carbon, 1.8K Ω , \pm 10%, 1/4W
P300	YD2818004 (ZZ2818004)	P.C. Board P. C. Board Assembly	R364	RT1056114	Carbon, 560 Ω , \pm 10%, 1/4W
R301	RT1010214	Carbon, 1K Ω , \pm 10%, 1/4W	R365	RA0502013	Trimmer, 5K Ω , B
R302-R303	RN1047414	Carbon, 470K Ω , \pm 10%, 1/4W	R366-R367	RT1022414	Carbon, 220K Ω , \pm 10%, 1/4W
R304	RT1015214	Carbon, 1.5K Ω , \pm 10%, 1/4W	R368	RT1047114	Carbon, 470 Ω , \pm 10%, 1/4W
R305	RT1027314	Carbon, 27K Ω , \pm 10%, 1/4W	R369	RT1047114	Carbon, 470 Ω , \pm 10%, 1/4W
R306	RT1012314	Carbon, 12K Ω , \pm 10%, 1/4W	R374	RT1068214	Carbon, 6.8K Ω , \pm 10%, 1/4W
R307	RT1012214	Carbon, 1.2K Ω , \pm 10%, 1/4W	RESISTORS		
R308	RT1015214	Carbon, 1.5K Ω , \pm 10%, 1/4W	C301-C302	EA1060169	Elect., 10 μ F, 10V
R309	RT1022214	Carbon, 2.2K Ω , \pm 10%, 1/4W	C303	DF5547203	Mylar, 4700pF, \pm 5%
R310	RT1027314	Carbon, 27K Ω , \pm 10%, 1/4W	C304	DF1647201	Mylar, 4700pF, \pm 10%
R311	RT1039114	Carbon, 390 Ω , \pm 10%, 1/4W	C306	EA1060169	Elect., 10 μ F, 16V
R312	RT1012214	Carbon, 1.2K Ω , \pm 10%, 1/4W	C311	EA1060169	Elect., 10 μ F, 16V
R313-R316	RT0510214	Carbon, 1K Ω , \pm 5%, 1/4W	C312	EA2270169	Elect., 220 μ F, 16V
R317	RT1010314	Carbon, 10K Ω , \pm 10%, 1/4W	C315-C316	DF1522301	Mylar, 0.022 μ F, \pm 5%
R318	RT1015314	Carbon, 15K Ω , \pm 10%, 1/4W	C317-C318	DF1722401	Mylar, 0.22 μ F, \pm 20%
R319	RT1015114	Carbon, 150 Ω , \pm 10%, 1/4W	C319-C320	EA1060359	Elect., 10 μ F, 35V
R320	RT1010414	Carbon, 100K Ω , \pm 10%, 1/4W	C321-C322	EA1060169	Elect., 10 μ F, 16V
R321	RT1022114	Carbon, 220 Ω , \pm 10%, 1/4W	C323	EA1070109	Elect., 100 μ F, 10V
R322-R323	RT1022414	Carbon, 220K Ω , \pm 10%, 1/4W	C324	EM1040201	Elect., 0.1 μ F, 20V
R324	RT1033014	Carbon, 33 Ω , \pm 10%, 1/4W	C331-C332	EA4750359	Elect., 4.7 μ F, 35V
R325	RT1012414	Carbon, 120K Ω , \pm 10%, 1/4W	C333-C334	EV1050251	Elect., 1 μ F, 25V
R326	RT1015314	Carbon, 15K Ω , \pm 10%, 1/4W	C335	EA2270259	Elect., 220 μ F, 25V
R327	RT1056214	Carbon, 5.6K Ω , \pm 10%, 1/4W	C336	EA3360109	Elect., 33 μ F, 10V
R328	RT1033314	Carbon, 33K Ω , \pm 10%, 1/4W	TRANSFORMERS		
R329	RT1022414	Carbon, 220K Ω , \pm 10%, 1/4W	L301	LS1001007	MPX Coil, 19KHz, Amp.
R330	RT1068314	Carbon, 68K Ω , \pm 10%, 1/4W	L302	LS1503002	MPX Coil, 19KHz, 38KHz Block
R331	RT1056314	Carbon, 56K Ω , \pm 10%, 1/4W	L304	LS1503001	MPX Coil, 19KHz, 67KHz Trap
R332	RT0518414	Carbon, 180K Ω , \pm 5%, 1/4W	L305	LS3501002	MPX Coil, L.P. Filter
R333	RT1010414	Carbon, 100K Ω , \pm 10%, 1/4W	SEMICONDUCTORS		
R334	RT1012414	Carbon, 120K Ω , \pm 10%, 1/4W	H301-H307	HT3037210	Transistor, 2SC372
R335-R336	RT0515314	Carbon, 15K Ω , \pm 5%, 1/4W	H308	HF200301C	Transistor, 2SK30Y
R337-R338	RT0510414	Carbon, 100K Ω , \pm 5%, 1/4W	H309-H310	HT307322A	Transistor, 2SC732 Bu or Gr
R339-R340	RN0582414	Carbon, 820K Ω , \pm 5%, 1/4W	H311-H312	HT104942A	Transistor, 2SA494 Gr or Y
R341-R342	RT0512214	Carbon, 3.3K Ω , \pm 5%, 1/4W	H313-H314	HT306441C	Transistor, 2SC644T
R343-R344	RN0522314	Carbon, 22K Ω , \pm 5%, 1/4W	H315-H320	HD1000105	Diode, 1N60
R345-R346	RT0568214	Carbon, 6.8K Ω , \pm 5%, 1/4W	J301-J303	YP1000094	MISCELLANEOUS Plug
R347-R348	RT0510214	Carbon, 1K Ω , \pm 5%, 1/4W	J305-J307	YP1000094	Plug
R349-R350	RT0512214	Carbon, 1.2K Ω , \pm 10%, 1/4W	J312-J315	YP1000094	Plug
R351-R352	RT0536214	Carbon, 3.6K Ω , \pm 10%, 1/4W	P500	YD2820004 (ZZ2820004)	P.C. Board P.C. Board Assembly
R353	RT1082314	Carbon, 82K Ω , \pm 10%, 1/4W	RESISTORS		
R354	RT1022214	Carbon, 2.2K Ω , \pm 10%, 1/4W	R501	RT1015114	Carbon, 150 Ω , \pm 10%, 1/4W
R355	RT1056314	Carbon, 56K Ω , \pm 10%, 1/4W	R502	RT1010214	Carbon, 1K Ω , \pm 10%, 1/4W
R356	RT1010414	Carbon, 100K Ω , \pm 10%, 1/4W	R503	RT1010114	Carbon, 100 Ω , \pm 10%, 1/4W
R357-R358	RN1047414	Carbon, 470K Ω , \pm 10%, 1/4W	R504	RT1022314	Carbon, 22K Ω , \pm 10%, 1/4W

REF. DESIG.	MARANTZ PART NO.	DESCRIPTION
C167	DK1710201	Ceramic, 0.001 μ F, \pm 20%
C168	DF1747201	Mylar, 0.0047 μ F, \pm 20%
C169	DF1722201	Mylar, 0.0022 μ F, \pm 20%
C170	DF1668301	Mylar, 0.068 μ F, \pm 10%
C171	EA1060169	Elect., 10 μ F, 16V
C172	DF1740301	Mylar, 0.04 μ F, \pm 20%
C173	EA1060169	Elect., 10 μ F, 16V
C174	DF1740301	Mylar, 0.04 μ F, \pm 20%
C175	EA1060169	Elect., 10 μ F, 16V
C176-C177	DF1740301	Mylar, 0.04 μ F, \pm 20%
C178	EA1060169	Elect., 10 μ F, 16V
C179	DF1740301	Mylar, 0.04 μ F, \pm 20%
C180	EA1060169	Elect., 10 μ F, 16V
C181	EA1060169	Elect., 10 μ F, 16V
C182	DD1620001	Ceramic, 20pF, \pm 10%
C183	EA1060169	Elect., 10 μ F, 16V
C184	EA1070109	Elect., 100 μ F, 10V
TRANSFORMERS		
L151	LA1001017	RF Coil, 200 μ H
L152	LO1001042	OSC Coil, 120 μ H
L153	LI1028002	IFT
L154	LI1001048	IFT
SEMICONDUCTORS		
H151-H152	HT309411B	Transistor, 2SC941 (O)
H153-H154	HT3037210	Transistor, 2SC372
H155	HT306441C	Transistor, 2SC644 (T)
H156-H159	HD1000105	Diode, 1N60
MISCELLANEOUS		
J151-J161	YP1000094	Plug
P200	YD2819008 (ZZ2819008)	P.C. Board P.C. Board Assembly
RESISTORS		
R201	RT1015114	Carbon, 150 Ω , \pm 10%, 1/4W
R202	RT1015214	Carbon, 1.5K Ω , \pm 10%, 1/4W
R203	RT1033214	Carbon, 3.3K Ω , \pm 10%, 1/4W
R204-R205	RT1010214	Carbon, 1K Ω , \pm 10%, 1/4W
R206	RT1082114	Carbon, 820 Ω , \pm 10%, 1/4W
R207	RT1015114	Carbon, 150 Ω , \pm 10%, 1/4W
R208	RT1015214	Carbon, 1.5K Ω , \pm 10%, 1/4W
R209	RT1033214	Carbon, 3.3K Ω , \pm 10%, 1/4W
R210-R211	RT1010214	Carbon, 1K Ω , \pm 10%, 1/4W
R212	RT1010414	Carbon, 100K Ω , \pm 10%, 1/4W
R213-R214	RT1015114	Carbon, 150 Ω , \pm 10%, 1/4W
R215	RT1082114	Carbon, 820 Ω , \pm 10%, 1/4W
R216	RT1015114	Carbon, 150 Ω , \pm 10%, 1/4W
R217	RT1015214	Carbon, 1.5K Ω , \pm 10%, 1/4W
R218	RT1033214	Carbon, 3.3K Ω , \pm 10%, 1/4W
R219-R220	RT1010214	Carbon, 1K Ω , \pm 10%, 1/4W
R221	RT1010414	Carbon, 100K Ω , \pm 10%, 1/4W
R222	RT1015114	Carbon, 150 Ω , \pm 10%, 1/4W
R223	RT1022114	Carbon, 220 Ω , \pm 10%, 1/4W

REF. DESIG.	MARANTZ PART NO.	DESCRIPTION
R224	RT10821140	Carbon, 820 Ω , \pm 10%, 1/4W
R225	RT1015114	Carbon, 150 Ω , \pm 10%, 1/4W
R226	RT1082214	Carbon, 8.2K Ω , \pm 10%, 1/4W
R227	RT1015314	Carbon, 15K Ω , \pm 10%, 1/4W
R228-R229	RT1010214	Carbon, 1K Ω , \pm 10%, 1/4W
R230	RT1027114	Carbon, 270 Ω , \pm 10%, 1/4W
R231	RT1010414	Carbon, 100K Ω , \pm 10%, 1/4W
R232	RT1082214	Carbon, 8.2K Ω , \pm 10%, 1/4W
R233	RT1015314	Carbon, 15K Ω , \pm 10%, 1/4W
R234	RT1015114	Carbon, 150 Ω , \pm 10%, 1/4W
R235-R236	RT1010214	Carbon, 1K Ω , \pm 10%, 1/4W
R237	RT1015114	Carbon, 150 Ω , \pm 10%, 1/4W
R238	RT1010414	Carbon, 100K Ω , \pm 10%, 1/4W
R239	RT1015114	Carbon, 150 Ω , \pm 10%, 1/4W
R240	RT1047114	Carbon, 470 Ω , \pm 10%, 1/4W
R241	RT1010114	Carbon, 100 Ω , \pm 10%, 1/4W
R242	RT1047214	Carbon, 4.7K Ω , \pm 10%, 1/4W
R243	RT1012314	Carbon, 12K Ω , \pm 10%, 1/4W
R244	RT1010214	Carbon, 1K Ω , \pm 10%, 1/4W
R245	RT1022214	Carbon, 2.2K Ω , \pm 10%, 1/4W
R246	RT1033314	Carbon, 33K Ω , \pm 10%, 1/4W
R247	RT1056314	Carbon, 56K Ω , \pm 10%, 1/4W
R248	RT1012314	Carbon, 12K Ω , \pm 10%, 1/4W
R249-R252	RT1010114	Carbon, 100 Ω , \pm 10%, 1/4W
R254	RT1010314	Carbon, 10K Ω , \pm 10%, 1/4W
R255	RT1018314	Carbon, 18K Ω , \pm 10%, 1/4W
R256	RT1022314	Carbon, 22K Ω , \pm 10%, 1/4W
R257	RT1027314	Carbon, 27K Ω , \pm 10%, 1/4W
R258	RT1022314	Carbon, 22K Ω , \pm 10%, 1/4W
R259	RT1012314	Carbon, 12K Ω , \pm 10%, 1/4W
CAPACITORS		
C201-C207	DK1710301	Ceramic, 0.01 μ F, \pm 20%
C208	DK1710201	Ceramic, 0.001 μ F, \pm 20%
C209-C212	DK1710301	Ceramic, 0.01 μ F, \pm 20%
C213	DK1810402	Ceramic, 0.1 μ F, \pm 80% -20%
C214-C217	DK1710301	Ceramic, 0.01 μ F, \pm 20%
C218	DK1810402	Ceramic, 0.1 μ F, \pm 80% -20%
C219-C225	DK1840302	Ceramic, 0.04 μ F, \pm 80% -20%
C226	DD1540001	Ceramic, 40pF, \pm 5%
C227	DD1620101	Ceramic, 200pF, \pm 10%
C228	DK1710301	Ceramic, 0.01 μ F, \pm 20%
C229	DD1620101	Ceramic, 200pF, \pm 10%
C230	DK1710301	Ceramic, 0.01 μ F, \pm 20%
C231	DD1620101	Ceramic, 200pF, \pm 10%
C232	DK1710301	Ceramic, 0.01 μ F, \pm 20%
SEMICONDUCTORS		
H201-H206	HT308291C	Transistor, 2SC829C
H207-H214	HD2001105	Diode, 1S1555
H215-H224	HD1000105	Diode, 1N60

REF. DESIG.	MARANTZ PART NO.	DESCRIPTION
P100	YD2819002 (ZZ2819002)	P.C. Board P.C. Board Assembly
RESISTORS		
R101	RT1056314	Carbon, 56K Ω , $\pm 10\%$, 1/4W
R102	RT1010514	Carbon, 1M Ω , $\pm 10\%$, 1/4W
R103	RT1010414	Carbon, 100K Ω , $\pm 10\%$, 1/4W
R104-R105	RT1022114	Carbon, 220 Ω , $\pm 10\%$, 1/4W
R106	RT1010214	Carbon, 1K Ω , $\pm 10\%$, 1/4W
R107	RT1047214	Carbon, 4.7K Ω , $\pm 10\%$, 1/4W
R108-R109	RT1022314	Carbon, 22K Ω , $\pm 10\%$, 1/4W
R110	RT1012214	Carbon, 1.2K Ω , $\pm 10\%$, 1/4W
R111-R113	RT1010114	Carbon, 100 Ω , $\pm 10\%$, 1/4W
R114	RT1022314	Carbon, 22K Ω , $\pm 10\%$, 1/4W
R115	RT1010114	Carbon, 100 Ω , $\pm 10\%$, 1/4W
CAPACITORS		
C101	CA4330001	Variable, FM4, AM3, Gang
C102	CT1100001	Trimmer, 1.5pF ~ 10pF, NPO
C103	CT1100002	Trimmer, 1.5pF ~ 10pF, NPO
C104-C106	CT1100001	Trimmer, 1.5pF ~ 10pF, NPO
C107	DD1615001	Ceramic, 15pF, $\pm 10\%$, SL
C108	DK1710201	Ceramic, 1000pF, $\pm 20\%$, YY
C109	DD1105001	Ceramic, 5pF, $\pm 0.5pF$, SL
C110	DK1710201	Ceramic, 1000pF, $\pm 20\%$, YY
C111	DD1615001	Ceramic, 15pF, $\pm 10\%$, SL
C112	DK1710201	Ceramic, 1000pF, $\pm 20\%$, YY
C113	DK1710301	Ceramic, 0.01 μF , $\pm 20\%$, YY
C114	DD1001001	Ceramic, 1.0pF, $\pm 0.25pF$, SL
C115	DD1615001	Ceramic, 15pF, $\pm 10\%$, SL
C116-C117	DK1710301	Ceramic, 0.01 μF , $\pm 20\%$, YY
C118	DD1620003	Ceramic, 20pF, $\pm 10\%$, SH
C119	DD1210006	Ceramic, 10pF, $\pm 1pF$, CH
C120-C121	DD1615003	Ceramic, 15pF, $\pm 10\%$, CH
C122-C125	DK1710301	Ceramic, 0.01 μF , $\pm 20\%$, YY
C127	DK1710301	Ceramic, 0.01 μF , $\pm 20\%$, YY
TRANSFORMERS		
L101	LA1202603	Ant. Coil
L102	LA1202604	RF Coil
L103	LA1202605	RF Coil
L104	LO1202603	OSC Coil
L105	LI1001601	IFT
SEMICONDUCTORS		
H101	HF200191A	Transistor, 2SK 19 Y
H102	HF200191B	Transistor, 2SK 19 G
H103	HT308291B	Transistor, 2SC 829 B
MISCELLANEOUS		
J101-J102	YP1000094	Plug
J103-J109	57271240W	Lug Eyelet
W101	YW2820002	Wire Material

REF. DESIG.	MARANTZ PART NO.	DESCRIPTION
P150	YD2818002 (ZZ2818002)	P.C. Board P.C. Board Assembly
RESISTORS		
R151	RT1033214	Carbon, 3.3K Ω , $\pm 10\%$, 1/4W
R152	RT1022414	Carbon, 220K Ω , $\pm 10\%$, 1/4W
R153	RT1039214	Carbon, 3.9K Ω , $\pm 10\%$, 1/4W
R154	RT1010414	Carbon, 100K Ω , $\pm 10\%$, 1/4W
R155	RT1022114	Carbon, 220 Ω , $\pm 10\%$, 1/4W
R156	RT1033214	Carbon, 3.3K Ω , $\pm 10\%$, 1/4W
R157	RT1015314	Carbon, 15K Ω , $\pm 10\%$, 1/4W
R158	RT1027214	Carbon, 2.7K Ω , $\pm 10\%$, 1/4W
R162	RT1018314	Carbon, 18K Ω , $\pm 10\%$, 1/4W
R163	RT1018414	Carbon, 180K Ω , $\pm 10\%$, 1/4W
R164	RT1010214	Carbon, 1K Ω , $\pm 10\%$, 1/4W
R165	RT1015214	Carbon, 1.5K Ω , $\pm 10\%$, 1/4W
R166	RT1018314	Carbon, 18K Ω , $\pm 10\%$, 1/4W
R167	RT1047314	Carbon, 47K Ω , $\pm 10\%$, 1/4W
R168	RT1010214	Carbon, 1K Ω , $\pm 10\%$, 1/4W
R169	RT1022114	Carbon, 220 Ω , $\pm 10\%$, 1/4W
R170	RT1015214	Carbon, 1.5K Ω , $\pm 10\%$, 1/4W
R171	RT1022214	Carbon, 2.2K Ω , $\pm 10\%$, 1/4W
R172	RT1047214	Carbon, 4.7K Ω , $\pm 10\%$, 1/4W
R173	RT1022414	Carbon, 220K Ω , $\pm 10\%$, 1/4W
R174	RT1022214	Carbon, 2.2K Ω , $\pm 10\%$, 1/4W
R175	RT1056214	Carbon, 5.6K Ω , $\pm 10\%$, 1/4W
R176	RT1010414	Carbon, 100K Ω , $\pm 10\%$, 1/4W
R177	RT1010214	Carbon, 1K Ω , $\pm 10\%$, 1/4W
R178	RT1010114	Carbon, 100 Ω , $\pm 10\%$, 1/4W
R179	RT1022214	Carbon, 2.2K Ω , $\pm 10\%$, 1/4W
R180	RT1010114	Carbon, 100 Ω , $\pm 10\%$, 1/4W
R181	RT1082114	Carbon, 820 Ω , $\pm 10\%$, 1/4W
R182	RT1056214	Carbon, 5.6K Ω , $\pm 10\%$, 1/4W
R183	RT1018314	Carbon, 12K Ω , $\pm 10\%$, 1/4W
R184	RT1082214	Carbon, 8.2K Ω , $\pm 10\%$, 1/4W
R185	RT1010114	Carbon, 100 Ω , $\pm 10\%$, 1/4W
R186	RT1056214	Carbon, 5.6K Ω , $\pm 10\%$, 1/4W
R187	RT1022214	Carbon, 2.2K Ω , $\pm 10\%$, 1/4W
R188	RT1010114	Carbon, 100 Ω , $\pm 10\%$, 1/4W
CAPACITORS		
C151	DF1740301	Mylar, 0.04 μF , $\pm 20\%$
C152	DF1710301	Mylar, 0.01 μF , $\pm 20\%$
C153	DF1740301	Mylar, 0.04 μF , $\pm 20\%$
C154	DD1105001	Ceramic, 5pF, $\pm 0.5pF$
C155	DF1740301	Mylar, 0.04 μF , $\pm 20\%$
C156	DF1747201	Mylar, 0.0047 μF , $\pm 20\%$
C157	DF1722301	Mylar, 0.022 μF , $\pm 20\%$
C158	DF6545101	Mylar, 450pF, $\pm 5\%$
C160	DF1740301	Mylar, 0.04 μF , $\pm 20\%$
C161-C162	EA1060169	Elect., 10 μF , 16V
C163	DF1740301	Mylar, 0.04 μF , $\pm 20\%$
C164-C166	EA1060169	Elect., 10 μF , 16V

REF. DESIG.	MARANTZ PART NO.	DESCRIPTION	REF. DESIG.	MARANTZ PART NO.	DESCRIPTION
0804	51570306B	P. H. tapt screw x 6	1033	54020401A	Flat washer P x 7
0806	51570312B	P. H. tapt screw x 5	1034	62031650W	Lug x 5
0807	54050300R	T. L. Washer x 2	1035	54050300R	T. L. washer OR x 10
0808	51100306E	B. H. M. Screw x 2	1102	51100306S	B. H. M. screw x 4
0809	51040306A	F. H. M. screw x 2	1103	51100306S	B. H. M. screw x 4
0810	51640412D	Set screw CP	1104	51100306S	B. H. M. screw x 4
0811	54040402A	Spring washer	1105	51100306S	B. H. M. screw x 4
0811	53110403E	Hexagon nut	1106	51100306S	B. H. M. screw x 5
0814	51570408B	P. H. tapt screw x 2	1107	51100306S	B. H. M. screw x 4
0815	51570306B	P. H. tapt screw x 4	1108	51100306S	B. H. M. screw x 5
0816	51570306B	P. H. tapt screw x 6	1109	51100306S	B. H. M. screw x 4
0818	51042606S	F. H. M. screw x 5	1110	51100306S	B. H. M. screw x 4
0820	51570306B	P. H. tapt screw x 3	1121	51570306B	P. H. tapt screw x 6
0821	51570306B	P. H. tapt screw x 5	1122	51570306B	P. H. tapt screw x 4
0822	51570306B	P. H. tapt screw	1123	51570306B	P. H. tapt screw x 4
0823	51570306B	P. H. tapt screw x 3	1124	51570306B	P. H. tapt screw x 8
0824	51570306B	P. H. tapt screw x 2	1125	51570306B	P. H. tapt screw x 2
0825	51570306B	P. H. tapt screw x 4	1126	51570306B	P. H. tapt screw x 4
0831	53110603A	Hexagon nut	1127	51570312B	P. H. tapt screw x 2
0832	54040602A	Spring washer	1128	51570306B	P. H. tapt screw x 2
0902	51100308S	B. H. M. Screw x 12	1129	51570306B	P. H. tapt screw x 10
0903	53110303E	Hexagon Nut x 12	1130	51570306B	P. H. tapt screw x 15
0905	55060307F	T. R. Rivet x 4	1202	51650304D	Set screw H. P. x 2
0906	54050300R	T. L. Washer OR x 4	1204	53110403E	Hexagon nut
0909	51100306S	B. H. tapt screw x 6	1206	54060300R	T. L. washer IR x 5
0910	51100306S	B. H. tapt screw x 3	1212	56382540G	Eyelet
0911	51100306S	B. H. tapt screw x 2	1216	51100310S	B. H. M. screw x 2
0912	51100306S	B. H. tapt screw x 2	1217	53110303E	Hexagon nut x 2
0913	51100306S	B. H. tapt screw x 2	1218	54050300R	T. L. washer OR x 2
0914	51570312B	P. H. tapt screw x 4	1225	51060305E	P. H. M. screw x 3
0917	51100304S	B. H. M. screw x 2	1227	51570306B	P. H tapt screw x 2
0919	51100308S	B. H. M. screw x 2	1229	54040302N	Spring washer x 4
0920	54050300R	TL Washer OR x 2			
0921	53110303E	Hexagon nut x 2			
0923	54050400R	TL washer OR			
0926	51122608E	T. H. M. screw x 4			
0928	51100406S	B. H. M. screw x 10			
0930	51100406S	B. H. M. screw x 4			
0931	54020401S	Flat washer P x 4			
0933	51570410B	P. H. tapt screw x 4			
0934	54020401E	Flat washer P x 4			
0935	54040402N	Spring washer x 4			
1002	51570306B	P. H. tapt screw x 16			
1003	51570306B	P. H. tapt screw x 8			
1013	51100306S	B. H. M. screw x 8			
1015	51100308S	B. H. M. screw x 2			
1024	62031650W	Lug			
1026	51570408B	P. H. tapt screw x 4			
1027	53110403A	Hexagon nut x 4			
1028	54020401A	Flat washer P x 4			
1031	51570408B	P. H. tapt screw x 4			
1032	53110401A	Hexagon nut x 4			

REF. DESIG.	MARANTZ PART NO.	DESCRIPTION
		MECHANICAL PARTS
A	282040140	Frame Assembly
0102	282006301	Escutcheon
0202	281840101	Frame
0204	281815801	Window
0215	273125901	Bush x 3
0219	281905302	Cover
0226	281825905	Bush x 9
B	281816040	Bracket Assembly (Front)
0311	281816001	Bracket
0206	281811801	Spacer
C	282016040	Bracket Assembly (Back)
0313	282016002	Bracket
0902	55060305F	T. R. rivet x 12
0905	55060365F	T. R. rivet x 4
J001	YT0304002	Terminal Push Type 4P, ANT.
J002	YT0201006	Terminal, Quad Radial
J003	YT0208002	Terminal, 8P
J006	YT0204003	Terminal, 4P Pre Out-Main-In
J011-J012	YJ0400018	AC Outlet Jack x 2
J008-J009	YT0304002	Terminal Push Type, 4P SPK x 2
0104	281815401	Knob x 8
0106	281815402	Knob
0108	281815403	Knob x 6
0117	281825702	Lid
0118	281825702	Lid
0121	257706302	Escutcheon
0122	257706303	Escutcheon
0123	257727301	Fly Wheel
0126	282026501	Indicator
0208	281810701	Sheet
0210	281810301	Pointer
0211	281810302	Pointer
0212	281805301	Cover
0217	275905701	Leg x 4
0221	281930201	Dial
0302	281810550	Chassis K
0308	273010401	Retainer
0315	281816003	Bracket
0316	281816004	Bracket
0321	281805501	Collar x 5
0323	281810102	Support x 2
0324	281810103	Support x 2
0326	281827401	Reflector
0327	281927401	Reflector
0329	281827101	Holder
0330	281927106	Holder
0331	281927101	Holder
0332	281927107	Holder
0333	281927102	Holder
0401	281805101	Guide

REF. DESIG.	MARANTZ PART NO.	DESCRIPTION
0403	281816005	Bracket
0406	281810650	Bearing K
0410	257811202	Shaft
0412	281826250	Pulley K
0417	281926251	Pulley K
0422	257912001	Insulator
0423	281812001	Insulator
0425	141511801	Spacer
0426	257710602	Bearing
0431	281905350	Cover K
0501	257816052	Bracket K
0506	145525901	Bush x 2
0508	53228059E	Nut
0510	281816006	Bracket
0516	282026701	Heat sink x 2
0518	281810104	Support x 8
0520	282016007	Bracket x 4
0524	257711806	Spacer x 6
0525	257711806	Spacer
0528	281926704	Heat sink x 4
0530	282026702	Heat sink x 2
0601	281800450	Table K
0605	273010950	Shield K
0609	273010902	Shield
0611	273010903	Shield x 3
0615	281916008	Bracket x 2
0617	281910901	Shield
0618	281912002	Insulator x 2
0619	282210903	Shield
0620	282210903	Shield
0623	281810107	Support x 4
0624	281816009	Bracket x 2
0626	281810906	Shield
0627	281810907	Shield
0629	281926901	Protector
0630	282126902	Protector
0631	282112001	Insulator
0633	281912001	Insulator x 2
0701	281915901	Drum
0703	71101569M	Spring
0706	282010701	Sheet
0707	281910701	Sheet
0711	120225801	Hook
0716	273025901	Bush x 3
0718	138200503	Clamper x 15
0722	72081602A	String 120
0725	257711803	Spacer x 4
0729	282111801	Spacer
0732	282100501	Clamper x 2
0734	281927103	Holder
0735	281905102	Guide
0802	51570305B	P. H. tapt screw x 8



marantz

MARANTZ CO., INC. • P.O. BOX 99 • SUN VALLEY, CALIFORNIA • 91352



A WHOLLY-OWNED SUBSIDIARY OF SUPERSCOPE INC., SUN VALLEY, CALIFORNIA 91352